

# Zehnder ComfoPost CW12

Air to water exchanger

Product data sheet

always the best climate

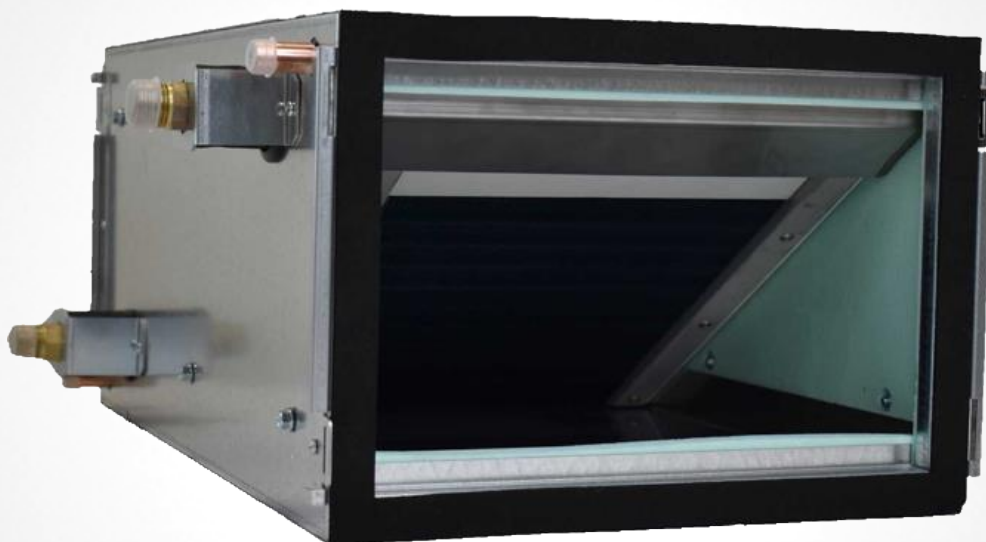

# ComfoPost CW12

The Zehnder ComfoPost is an air to water exchanger for use with ComfoWell air distribution connections. The ComfoWell connections allows for selection flexibility, offering a range of rigid circular ductwork or Zehnder ComfoTube semi-rigid ductwork to attached. The ComfoPost is available in a variety of sizes to heat or cool the air supplied by the Zehnder ventilation system.

The ComfoPost units are suitable for a wide range of airflows up to 166 l/s (600 m<sup>3</sup>hr). The units are made of steel with aluminium and copper pipe forming the heating and cooling coils and are maintenance free.

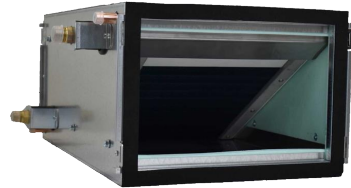

## Key Features

- Ideal for use with reversible heat pumps or chillers to meet SAP 10 or TM59 overheating demands
- Low pressure losses
- Filtered fresh supply air, not recycled stale air
- Suitable for use with the unique modular ComfoWell manifolds
- Suitable for horizontal or vertical installation
- Condensation water tray and drain as standard
- Suitable for Passive House application
- Corrosion resistant

## Article Numbers

Description	Product Code
<b>Air to water exchanger</b> Zehnder ComfoPost CW12 post-treatment battery for heating and cooling with an airflow up to 600 m <sup>3</sup> /h	399 000 003

## Zehnder ComfoPost CW12 post-treatment battery for heating and cooling with an airflow up to 600 m<sup>3</sup>/h

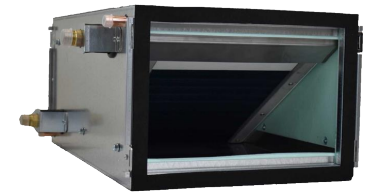

Article number: 399 000 003

## Technical Specification

Water connection diameter (ø)	1/2
Water connection type	BSPT tapered male thread
Condensate drain diameter OD (ø)	14 mm
Condensate connection type	Worm drive clip to fix to hose or crimped to copper pipe
ComfoWell range	ComfoWell 625
ComfoWell rigid round air connection options (ø)	150 mm / 160 mm / 180 mm / 200 mm
ComfoWell semi-rigid air connection options (ø)	12 x 75 mm / 12 x 90 mm / 6 x 90 mm + 6 x 75 mm
Material	Casing: Galvanised sheet steel Tubes: Copper Fins: Aluminium with hydrophilic treatment
Recommended operating water temperature range	7 to 55°C
Recommended maximum operating air flow	<166.6 l/s (<600 m <sup>3</sup> hr)
Maximum thermal heating output	5.34 kW*
Maximum thermal cooling output	6.53 kW*
Maximum operating water pressure	6 bar
Water volume capacity	1.2 Litres
Maintenance free	Yes
Weight	22.4 kg

\*Total capacity (sensible and latent) based on test conditions shown in the Performance Data table

## Pressure Curve

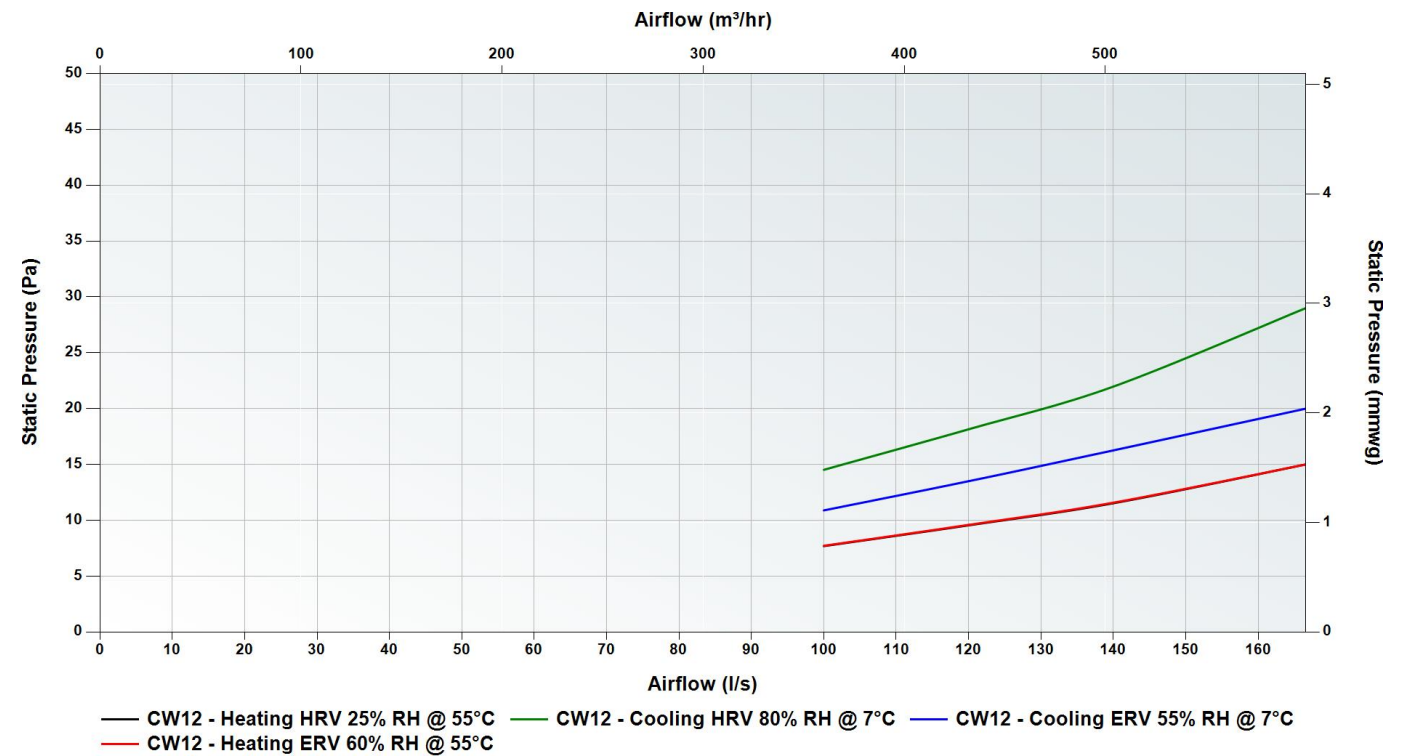

## Dimensions

Height	230 mm
Width	625 mm
Depth	520 mm

Front View

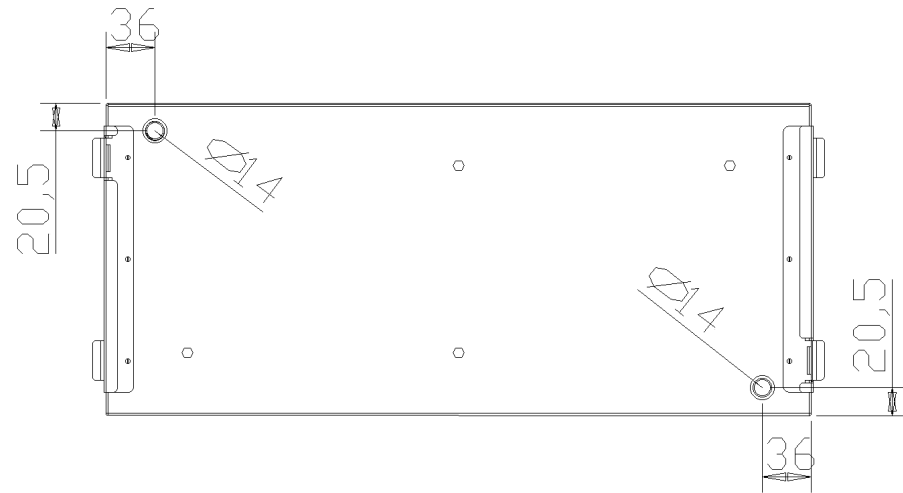

Rear View

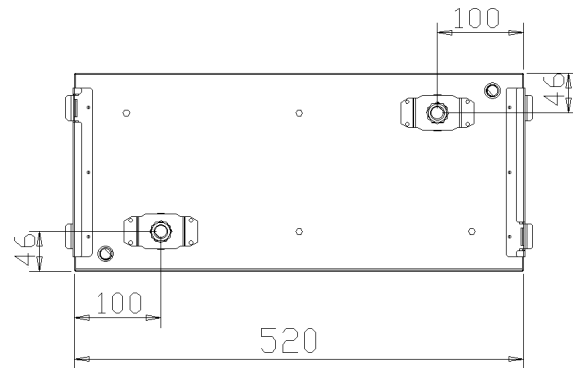

Side View

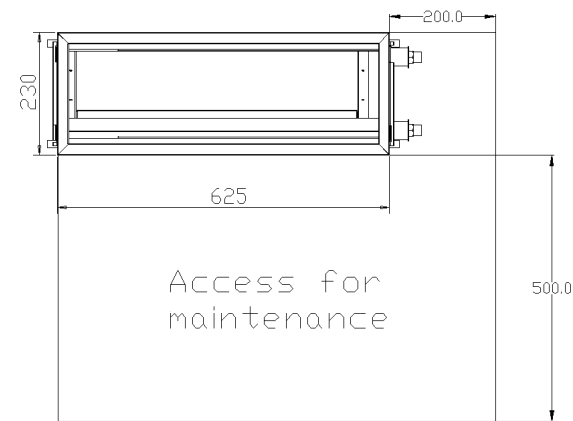

Top View

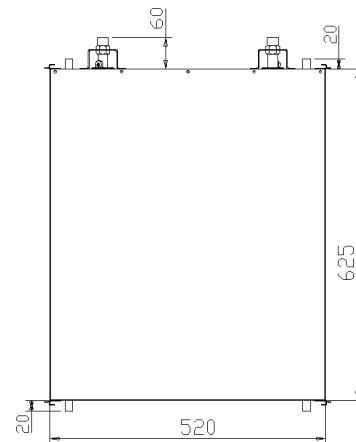

## 3D System Layout

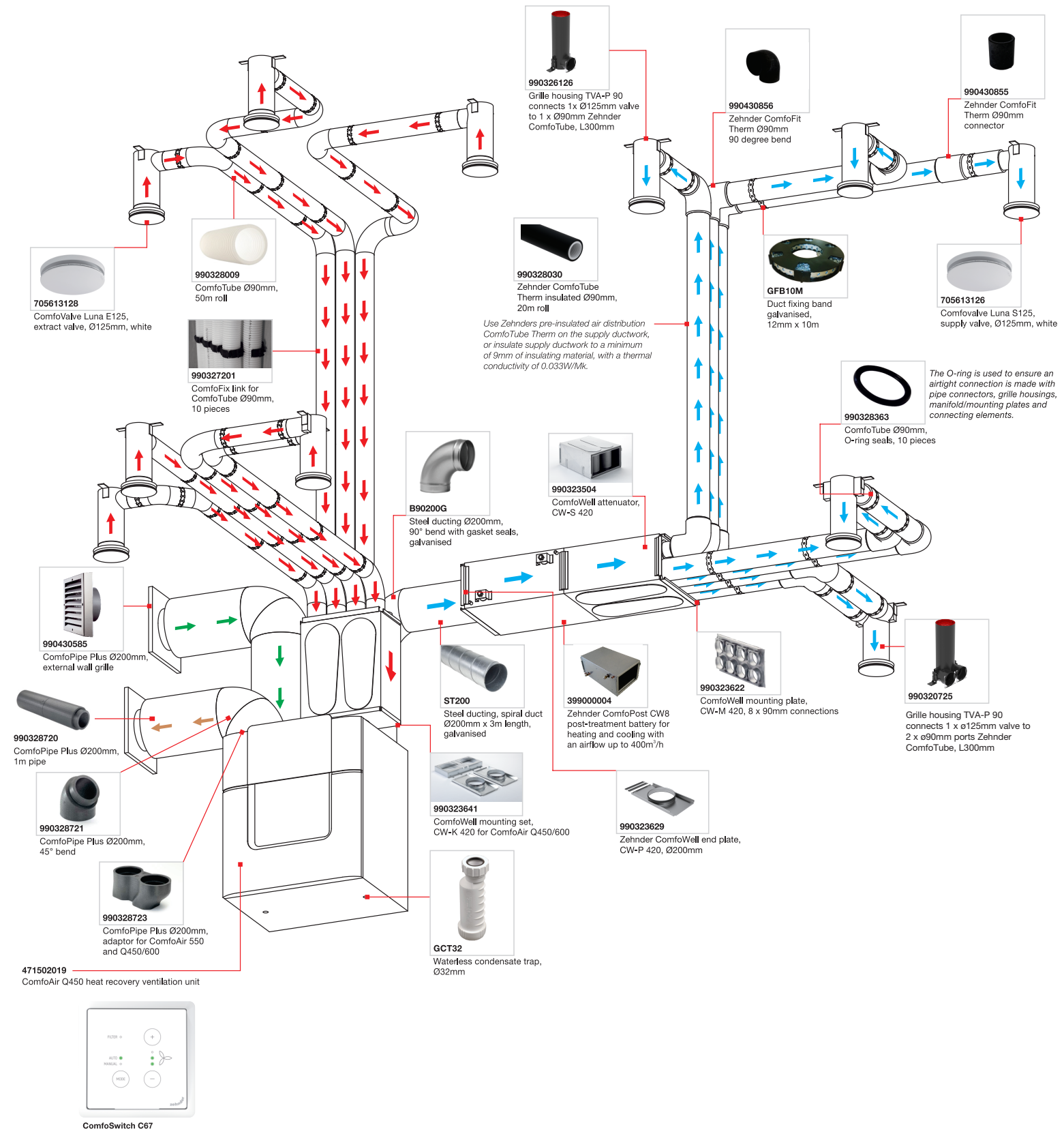

## Performance Data

Air conditions IN to ComfoPost		Heating								Cooling		
		HRV exchanger				ERV exchanger				HRV	ERV	
		T °C	18°C				17°C				27°C	28°C
		RH %	25%				60%				80%	55%
AH	3.2 g/kg				7.3 g/kg				18.1 g/kg	13.1 g/kg		
Water temperature IN	°C	55	50	45	40	55	50	45	40	7	7	
MINIMUM Air flow 100 l/s (360 m³/h)	H <sub>2</sub> O	l/h	600				600				600	600
	H <sub>2</sub> O temperature out	°C	49	45	41	36	49	45	40	36	13	12
	H <sub>2</sub> O	kPa	15	15	16	16	15	15	16	16	19	19
	Air temperature out	°C	52	47	43	38	52	47	43	38	13	12
	Air RH out	%	4	5	6	8	9	11	14	18	100	96
	Air AH out	g/kg	3.2	3.2	3.2	3.2	7.2	7.2	7.2	7.2	9.5	8.1
	Air ΔP	Pa	8	8	8	7	8	8	8	7	15	11
	Condensation	l/h	-	-	-	-	-	-	-	-	3.7	2.2
	Sensible power	kW	-	-	-	-	-	-	-	-	1.7	2
	TOTAL POWER	kW	4.14	3.57	3.01	2.45	4.27	3.71	3.14	2.58	4.31	3.52
Air flow 120 l/s (432 m³/h)	H <sub>2</sub> O	l/h	600				600				600	600
	H <sub>2</sub> O temperature out	°C	48	44	40	36	48	44	40	36	14	13
	H <sub>2</sub> O	kPa	15	16	16	16	15	16	16	16	19	19
	Air temperature out	°C	51	47	42	38	51	46	42	37	14	12
	Air RH out	%	4	5	6	8	9	11	14	18	100	95
	Air AH out	g/kg	3.2	3.2	3.2	3.2	7.2	7.2	7.2	7.2	10.2	8.5
	Air ΔP	Pa	10	9	9	9	10	9	9	9	18	14
	Condensation	l/h	-	-	-	-	-	-	-	-	4.1	2.4
	Sensible power	kW	-	-	-	-	-	-	-	-	1.9	2.3
	TOTAL POWER	kW	4.81	4.16	3.5	2.85	4.98	4.31	3.65	3	4.78	3.94
Air flow 140 l/s (504 m³/h)	H <sub>2</sub> O	l/h	600				600				600	600
	H <sub>2</sub> O temperature out	°C	47	43	39	35	47	43	39	35	14	13
	H <sub>2</sub> O	kPa	15	16	16	16	15	15	16	16	19	19
	Air temperature out	°C	50	46	41	37	50	45	41	37	15	13
	Air RH out	%	4	5	7	8	10	12	15	19	100	93
	Air AH out	g/kg	3.2	3.2	3.2	3.2	7.2	7.2	7.2	7.2	10.8	8.9
	Air ΔP	Pa	12	11	11	11	12	11	11	11	22	16
	Condensation	l/h	-	-	-	-	-	-	-	-	4.4	2.6
	Sensible power	kW	-	-	-	-	-	-	-	-	2.1	2.6
	TOTAL POWER	kW	5.44	4.7	3.96	3.22	5.62	4.87	4.13	3.38	5.17	4.31
MAXIMUM Air flow 166.6 l/s (600 m³/h)	H <sub>2</sub> O	l/h	600				600				600	600
	H <sub>2</sub> O temperature out	°C	46	42	38	35	46	42	38	34	15	14
	H <sub>2</sub> O	kPa	16	16	16	16	16	16	16	16	19	19
	Air temperature out	°C	48	44	40	36	48	44	40	36	16	14
	Air RH out	%	5	6	7	9	10	13	16	20	99	92
	Air AH out	g/kg	3.2	3.2	3.2	3.2	7.2	7.2	7.2	7.2	11.3	9.3
	Air ΔP	Pa	15	15	15	15	15	15	15	15	29	20
	Condensation	l/h	-	-	-	-	-	-	-	-	4.8	2.7
	Sensible power	kW	-	-	-	-	-	-	-	-	2.3	2.8
	TOTAL POWER	kW	6.3	5.44	4.59	3.73	6.51	5.64	4.78	3.92	5.64	4.73

Initial temperature and humidity outdoor/indoor: winter 2°C 70% R.H. / 20°C 60% R.H.; summer 35°C 50% R.H. / 25°C 50% R.H.  
The calculations include the cold recovery efficiency of an enthalpy exchanger as extrapolated from the results provided by the PHI certification

## Schematics

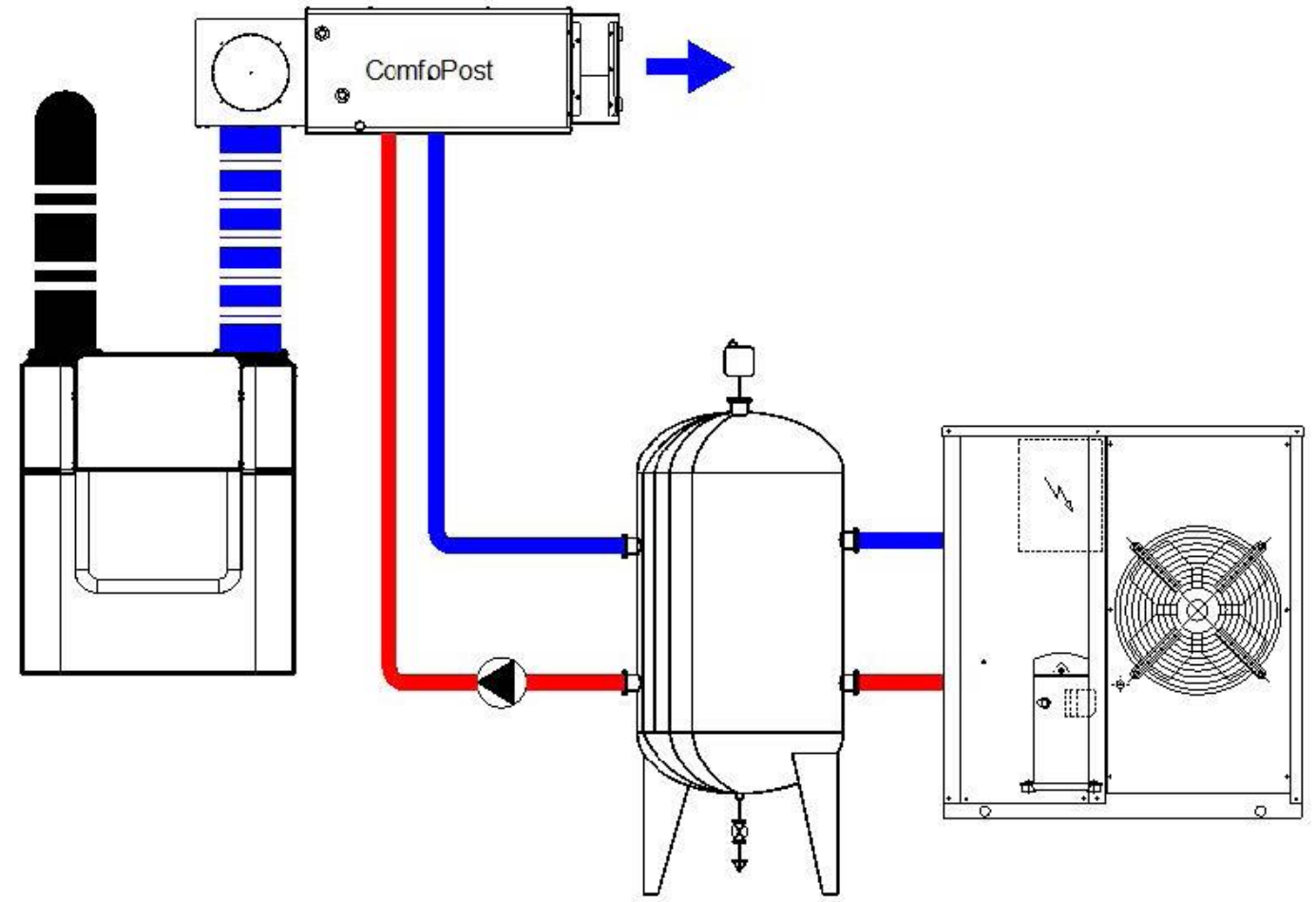

## Example Connection

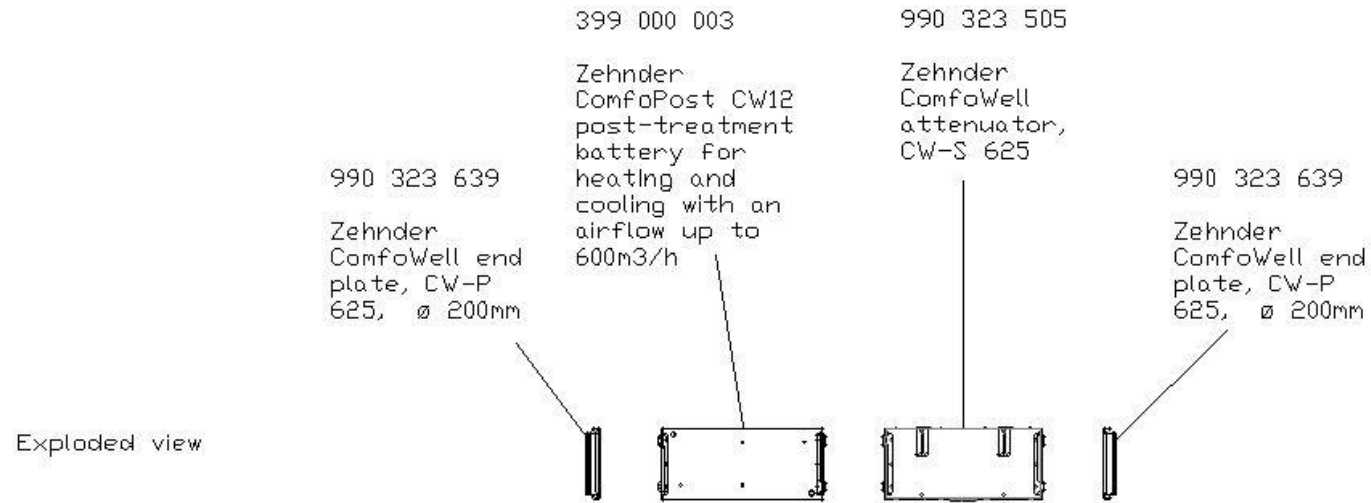

Front view

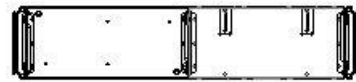

Top view

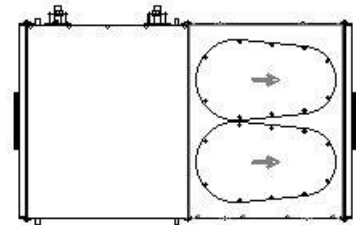

## For use with

Our range of ComfoPost products can be used in conjunction with our ComfoAir units, complete with enthalpy cube for improved sensible cooling capacity.

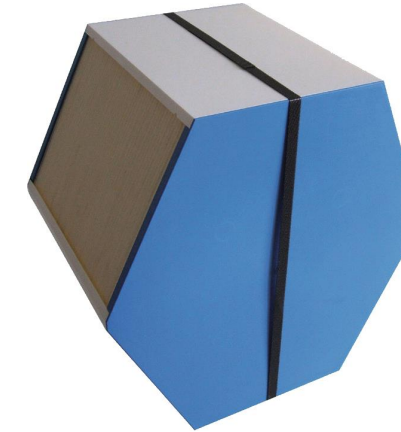

TO VIEW OUR ENTHALPY CUBE DATASHEET

[CLICK HERE](#)

## BIM/CAD Components

If you would like to download the BIM / CAD files for this or any other of our products then please visit our BIM library.

TO VISIT OUR BIM/CAD LIBRARY

[CLICK HERE](#)

## Installation Instructions

If you would like to download the installation files for this or any other of our products then please visit our download page by clicking the link below.

TO VISIT OUR DOWNLOAD PAGE

[CLICK HERE](#)

## Consultant Specification

### Specification

The air to water exchanger shall be constructed of galvanised sheet steel with copper tubes and aluminum fins with hydrophilic treatment to enhance thermal transfer. It shall be connected to the MVHR units supply ductwork with options to combine attenuators, manifold box, filter housing with ISO ePM1 >80% (F7), ISO ePM1 >90% (F9) or active carbon filters and end plates ranging from Ø 125 mm to Ø 200 mm. It shall have the option for horizontal or vertical mounting.

The unit shall be manufactured by Zehnder.