



Keyless Connected Smart Lock Manual



Please read the instructions before fitting and using the Keyless Connected lock.

The functions and design of this product can be changed without prior notice for performance and quality improvements.

The smarter way to protect your home.



Contents

Introduction	Safety Precautions	4
	Product Features	5
Getting Started	Lock Overview	6
	Set/Change Master Code	8
	Set/Delete User Code	9
	Set One Day Codes	11
	Register/Delete Key Cards/Tags	12
	Register/Delete Remote fobs	14
	Change Re-lock Time	16
Auto Re-lock on/off	17	
	Volume setting	18
Smart Home	Lock Module	19
	Connecting to a Home Automation System	20
Operating the lock	Unlocking the door	22
Security Features	Intrusion Alarm	23
	Incorrect PIN Lockout	24
	Emergency Power	25
	Resetting the lock	26
	Specifications	27
Guarantee	Guarantee	28
User Log	User Log	29
	User Keycard/Tag log	30
	Remote Fob log	31

Introduction

Thank you for choosing the Yale Keyless Connected smart lock.

This new Smart Lock uses the latest technology to make your life easier.

This user manual enables you to operate the product safely and to its full potential.

Please ensure you read it completely before using the Yale Keyless Connected Smart Lock.

Safety Precautions

Please read this carefully

Be careful not to let any unauthorised user discover your PIN code.

Please keep your PIN code safe.



To maintain the high quality finish, clean regularly with a soft damp cloth taking care not to scratch the finish. Do not use any chemicals when cleaning as this may affect your warranty.



The Keyless Digital Lock requires you to place your palm on the touch screen. This is a safety feature so finger print showing the PIN code are wiped.

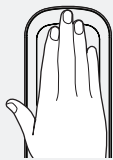

Caution Make sure to follow the above instructions to avoid any injuries or damage to the product .

Product Features



How To Open The Lock	Connected Ready	Yale® Module	Z-Wave® Module
4 - 10 digit PIN code	✓	✓	✓
24 hour PIN code for visitors	✓	✓	✓
Key Card (includes one card)	✓	✓	✓
Key Tag (includes one tag)	✓	✓	✓
Control with Yale® app (when linked to Yale® alarm or CCTV)	-	✓	-
Open through third party app	-	-	✓

You can use a mix of up to 20 PIN codes, key tags, key cards and remote fobs plus app control (model dependant).

Security			
3 minute lock out if code is entered incorrectly 5 times	✓	✓	✓
Tamper alarm	✓	✓	✓

Features			
Replaces existing rim cylinder used on a 60mm backset nightlatch	✓	✓	✓
Touchscreen with backlit keypad	✓	✓	✓
Battery operated	✓	✓	✓
Low battery indicator with emergency battery connection	✓	✓	✓
User codes and settings remain if batteries are replaced	✓	✓	✓
Remotely add user user credentials	-	-	✓
User schedules	-	-	✓
Audit trails	-	-	✓

Connectivity			
Connects to Yale® Alarm and CCTV range	-	✓	-
Connects to Z-Wave® compatible smart home systems	-	-	✓

Optional Accessories			
Remote Fob Module (includes one fob)	✓	-	-
Additional Remote Fobs	✓	-	-
Yale® Module	✓	-	✓
Z-Wave® Module	✓	✓	-
Key Card	✓	✓	✓
Key Tag	✓	✓	✓

Lock Overview

Basic Contents

The contents of this product may be subject to change without notice for performance or quality improvement.

» Basic Contents



Front (Front Body)



Back (Main Body)



Handing Plate



1 x Key Card
1 x Key Tag

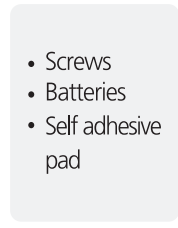

Accessories



User Guide



Installation Guide

» Optional Accessories

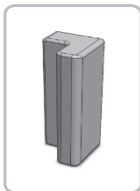

Home Automation
Module (Optional)

Identification

Front (Front Body installed on the outside of the door)

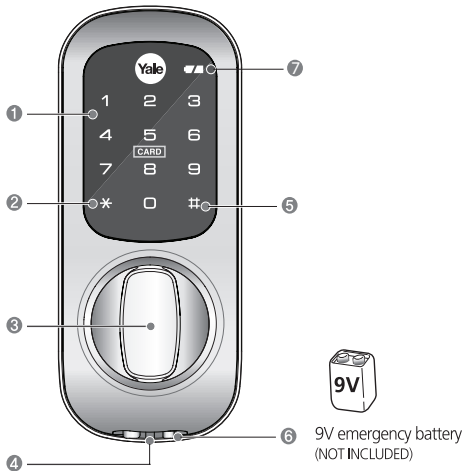

1	Keypad (10-Key)
2	* button
3	Knob handle
4	Reset button
5	# button
6	Emergency 9V power supply terminal
7	Low Battery Indicator

Back (Back Body, installed on the inside of the door)

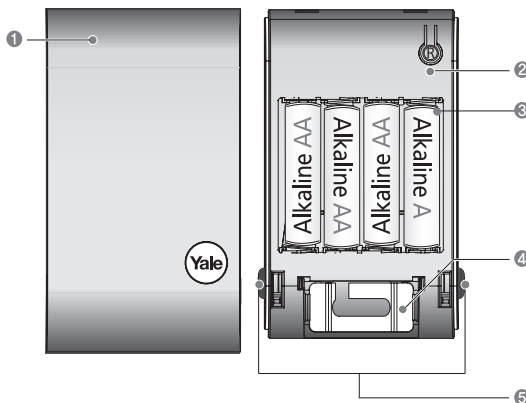





1	Battery pack cover
2	® Registration button
3	1.5V AA alkaline batteries
4	Fixing plate
5	Cover release button : press both simultaneously to release

Changing Master Code











Registration

The master code is the main password to the lock. As well as allowing entry through the door, it is also used to configure the lock including adding and removing users.

Step	Icon	Expected Feedback	Description
Touch the Keypad with the palm of your hand		Keypad will illuminate followed by 2 tone beep	Touch the Keypad to begin
Enter the master code, followed by # key		2 tone beep	If you are setting the code for the first time the default is 123456.
Select the [1] button followed by # key		2 tone beep after each button pressed	You are now in the lock's menu, choose option number 1 to change the master code.
Enter a new master code			The master code must be 6 digits
Enter a new master code		3 tone ascending beep Followed by your new code being illuminated	This completes the master code setup.

Setting a User Code





The lock can hold up to 20 unique user codes, each one has a slot in the lock's memory from 1 to 20. If a new code is written to a slot that already holds a code it will overwrite it. Because of this it is important to record which codes are stored in each slot. Please use the section in the back of the book to record this.

Step	Icon	Expected Feedback	Description
Touch the Keypad with the palm of your hand		Keypad will illuminate followed by 2 tone beep	Touch the Keypad to begin
Enter the master code, followed by # key	 	2 tone beep	If you have forgotten the master code please see the resetting the lock section of the manual.
Select the [2] button followed by # key	 	2 tone beep after each button pressed	You are now in the lock's menu, choose option number 2 to select the user code setup.
Press the [1] button and then #	 	2 tone beep after each button pressed	Option number 1 adds or modifies a user code
Enter the slot number for the user code followed by # key	 	2 tone beep	This is the number of the slot in memory where the code will be saved (1-20)
Enter the new user code	 	3 tone ascending beep Followed by your new code being illuminated	The user code can be between 4-10 digits

To add multiple codes please complete the above instructions, record that the memory slot has been filled in the user code log at the back of this guide, then repeat this process.





Deleting a User Code

To stop a user having access their code will need to be deleted. Before doing this you will first need to know which slot in the locks memory their code is in. Please see the user code log at the back of the guide.

Step	Icon	Expected Feedback	Description
Touch the Keypad with the palm of your hand		Keypad will illuminate followed by 2 tone beep	Touch the Keypad to begin
Enter the master code, followed by # key		2 tone beep	If you have forgotten the master code please see the resetting the lock section of the manual.
Select the [2] button followed by # key		2 tone beep after each button pressed	You are now in the lock's menu, choose option number 2 to select the user code setup.
Press the [3] button and then #		2 tone beep after each button pressed	Option number 3 deletes a user code
Enter the slot number for the user code followed by # key		3 tone ascending beep	This is the number of the slot in memory where the code will be saved (1-20)





Setting a One Day Code

The one day code is a code that will automatically expire after 24 hours. This allows short term access to be granted to someone.

Step	Icon	Expected Feedback	Description
Touch the Keypad with the palm of your hand		Keypad will illuminate followed by 2 tone beep	Touch the Keypad to begin
Enter the master code, followed by # key		2 tone beep	If you have forgotten the master code please see the resetting the lock section of the manual.
Select the [5] button followed by # key		2 tone beep after each button pressed	You are now in the lock's menu, choose option number 5 to enter the one day code settings.
Enter the new user code		2 tone beep	The user code must be 4 digits
Press the # button to finish.		3 tone ascending beeps followed by your new code being illuminated	The code will now be active for 24 hours

Deleting a One Day Code

A one day code can be deleted if it is no longer wanted. If not it will expire at the end of the 24 hour period.

Step	Icon	Expected Feedback	Description
Press any button		Keypad will illuminate followed by 2 tone beep	Press any button on the keypad to begin
Enter the master code, followed by # key		2 tone beep	If you have forgotten the master code please see the resetting the lock section of the manual.
Select the [5] button followed by # key		2 tone beep after each button pressed	You are now in the lock's menu, choose option number 5 to enter the one day code settings.
Press the # button to finish.		3 tone ascending beep	Press the # to confirm code deletion.

Adding a Key Card/Tag



The lock can hold up to 20 Key cards/tags, each one has a slot in the locks memory from 1 to 20. If a new card/tag is written to a slot that already holds a code it will overwrite it. Because of this it is important to record which cards/tags are stored in each slot. Please use the section in the back of the book to record this.

Step	Icon	Expected Feedback	Description
Touch the Keypad with the palm of your hand		Keypad will illuminate followed by 2 tone beep	Touch the Keypad to begin
Enter the master code, followed by # key		2 tone beep	If you have forgotten the master code please see the resetting the lock section of the manual
Select the [3] button followed by # key		2 tone beep after each button pressed	You are now in the lock's menu, choose option number 0 to select the Key Card/tag setup
Press the [1] button and then #		2 tone beep after each button pressed	Option number 1 adds an Key Card or tag
Enter the slot number for the user code followed by # key		2 tone beep	This is the number of the slot in memory where the code will be saved (1-20)
Present the Key Card/ Tag to lock		Single tone beep followed by slot number illuminating	Hold an Key Card or tag against the keypad until you hear the beep
Press # key		3 tone ascending beep	The card or tag is now added and will unlock the door

To add multiple Key Cards/tags please complete the above instructions, record that the memory slot has been filled in the user code log at the back of this guide, then repeat this process.

Deleting a Key Card/Tag



Key Card



Key Tag

The lock can hold up to 20 Key cards/tags, each one has a slot in the locks memory from 1 to 20. If a new card/tag is written to a slot that already holds a code it will overwrite it. Because of this it is important to record which cards/tags are stored in each slot. Please use the section in the back of the book to record this.

Step	Icon	Expected Feedback	Description
Touch the Keypad with the palm of your hand		Keypad will illuminate followed by 2 tone beep	Touch the Keypad to begin
Enter the master code, followed by # key		2 tone beep	If you have forgotten the master code please see the resetting the lock section of the manual.
Select the [0] button followed by # key		2 tone beep after each button pressed	You are now in the lock's menu, choose option number 0 to select the Key Card/tag setup.
Press the [3] button and then #		2 tone beep after each button pressed	Option number 1 adds an RFID card or tag.
Enter the slot number for the user code followed by # key		2 tone beep	This is the number of the slot in memory where the code will be saved (1-20).
Press # key		3 tone ascending beep	The card or tag is now deleted and will no longer unlock the door.



Remote Keyfob

Register Remote Fob





Yale Remote fobs allow you to open the lock at a distance of up to 15 metres. This requires both the Yale Remote fob and the corresponding lock module to work. Up to 5 Remote fobs can be registered on 1 lock, and like the user codes they each have their unique slot in the lock memory. Adding a new fob into a slot that already contains a fob will override it.

Step	Icon	Expected Feedback	Description
Touch the Keypad with the palm of your hand		Keypad will illuminate followed by 2 tone beep	Touch the Keypad to begin.
Enter the master code, followed by # key		2 tone beep	If you have forgotten the master code please see the resetting the lock section of the manual.
Select the [3] button followed by # key		2 tone beep after each button pressed	You are now in the lock's menu, option 3 contains the Remote fob settings.
Select the [1] button followed by # key		2 tone beep after each button pressed	This puts the lock into fob add mode
Enter the slot number for the fob followed by #		2 tone beep	Select the number of the slot in memory where the fob will be saved (1-5)
Push both unlock buttons on Remote fob		Single beep	Press both buttons as shown in diagram below.
Press the # button to confirm.		3 tone ascending beep	The fob will now unlock the lock.







Delete Previously Paired Remote Fob

If a Remote fob is lost or stolen it can be removed from the lock so that it can no longer be used to open it.

Step	Icon	Expected Feedback	Description
Touch the Keypad with the palm of your hand		Keypad will illuminate followed by 2 tone beep	Touch the Keypad to begin.
Enter the master code, followed by # key		2 tone beep	If you have forgotten the master code please see the resetting the lock section of the manual.
Select the [3] button followed by # key		2 tone beep after each button pressed	You are now in the lock's menu, option 3 contains the Remote fob settings
Press the [3] button followed by # key		2 tone beep after each button pressed	This puts the lock into fob delete mode.
Enter the slot number for the fob followed by #		2 tone beep, then 3 tone ascending beep	Select the number of the slot in memory where the fob is saved (1-5)





Change PIN Relock Time

The relock time is the amount of time it takes for the external handle to disengage after the lock has been unlocked with a correct PIN. The default is 7 seconds.

Step	Icon	Expected Feedback	Description
Touch the Keypad with the palm of your hand		Keypad will illuminate followed by 2 tone beep	Touch the Keypad to begin.
Enter the master code, followed by # key		2 tone beep	If you have forgotten the master code please see the resetting the lock section of the manual.
Select the [6] button followed by # key		2 tone beep after each button pressed	You are now in the lock's menu, option 6 contains the Remote fob settings.
Input the relock time (7-60)			The relock time can be between 7 and 60 seconds.
Press the # button to finish.		3 tone ascending beep	The relock time will now be set.





Change Remote Relock Time

The lock can be set to unlock for longer periods of time unlocked remotely by a Remote fob or a home automation system.

Step	Icon	Expected Feedback	Description
Touch the Keypad with the palm of your hand		Keypad will illuminate followed by 2 tone beep	Press any button on the keypad to begin
Enter the master code, followed by # key		2 tone beep	If you have forgotten the master code please see the resetting the lock section of the manual.
Select the [7] button followed by # key			You are now in the lock's menu, option 7 contains the Remote fob relock settings
Input the relock time (10-90)		2 tone beep after each button pressed	The relock time can be between 10 and 90 seconds.
Press the # button to finish.		3 tone ascending beep	The relock time will now be set.









Auto Re-lock On/Off

The lock can be toggled between two modes. With auto re-lock mode on the lock will automatically re-lock after the configured re-lock time. With auto re-lock mode off the lock will not re-lock until the keypad is awoken by placing your palm on it.

Step	Icon	Expected Feedback	Description
Touch the Keypad with the palm of your hand		Keypad will illuminate followed by 2 tone beep	Touch the Keypad to begin
Enter the master code, followed by # key		2 tone beep	If you have forgotten the master code please see the resetting the lock section of the manual.
Select the [9] button followed by # key		2 tone beep after each button pressed	You are now in the lock's menu, option 8 contains the silent mode settings.
Press [1] for auto re-lock on, or [3] for auto re-lock off.		2 tone beep	Select between the two modes
Press the # button to finish.		3 tone ascending beep	

Volume Mode

The lock can be toggled between three volume modes. In silent mode only programming beeps will be heard. In quite mode the keypad beeps will be quieter, in loud mode they will be loud.

Step	Icon	Expected Feedback	Description
Touch the Keypad with the palm of your hand		Keypad will illuminate followed by 2 tone beep	Touch the Keypad to begin
Enter the master code, followed by # key	 	2 tone beep	If you have forgotten the master code please see the resetting the lock section of the manual.
Select the [8] button followed by # key	 	2 tone beep after each button pressed	You are now in the lock's menu, option 8 contains the silent mode settings.
Press [1] to for silent mode, [2] for quite mode, or [3] for loud mode.	 	2 tone beep	Select between the three modes
Press the # button to finish.		3 tone ascending beep	

Smart Home

Lock Module

The Yale Keyless Connected Smart Lock is compatible with Z-Wave® and Yale modules for easy integration to smart home systems. In addition there is a module available for use with remote fobs.

- Z-Wave Module: Using the Z-Wave module, the Keyless Connected lock can be compatible with Z-Wave technology, allowing connection to approved third party smart home products
- Yale Module: The Keyless Connected lock can be connected to the Yale SmartPhone alarm and CCTV range, allowing you to open your door using the Yale Alarm or CCTV app
- Yale Remote Fob Module: The Keyless connected lock can be opened using a remote fob

Please note: if you connect your lock to a smart home system detailed above you will not be able to use the remote fob. For more information on the compatibility of the lock modules visit: www.yale.co.uk/smart-living



Removing the module.

To find out which module is currently in your lock please follow the 'removing a module' instructions.

Step	Icon	Description
Remove inside cover		Press the two release buttons on the side of the battery pack and remove cover
Remove a battery from the lock		Remove any of the batteries to cut power to the lock.
Remove the module		The module is situated in the top left corner above the batteries. It can be unplugged by pulling it out.
Record module model number		The model number will be on a sticker on the module, and will enable you to find the current wireless compatibility of the lock.

Inserting a Module





Step	Icon	Description
Remove inside cover		Press the two release buttons on the side of the battery pack and remove cover
Remove a battery from the lock		Remove any of the batteries to cut power to the lock.
Insert the module		The module has 8 pins that are plugged into the small black connector above the batteries on the top left of the lock.

Please Note: You cannot use a remote fob and use the Keyless Connected Smart Lock with a home automation system.

Smart Home

Connecting to a Home Automation System

Connecting to a home automation system is a two way process and may require the home automation system to be configured to look for a new device, please consult the manual that came with the system for more information.

Step	Icon	Expected Feedback	Description
Press any button		Keypad will illuminate followed by 2 tone beep	Touch the Keypad to begin
Enter the master code, followed by # key		2 tone beep	If you have forgotten the master code please see the resetting the lock section of the manual.
Press the [4] button followed by # key		2 tone beep after each button pressed	You are now in the lock's menu, option 4 contains the home automation settings
Press the [1] button followed by the hash key		2 tone beep after each button pressed	This will make the lock look for a compatible system
Please wait up to 60 seconds		3 tone ascending beep	The lock will now be linked to the home automation system.

Smart Home

Disconnecting from a Home Automation System

For security reasons a lock will not connect to a new home automation system if it is linked to another. If you have changed your home automation system please run through the disconnecting settings before adding the new one.

Step	Icon	Expected Feedback	Description
Touch the Keypad with the palm of your hand		Keypad will illuminate Touch the Keypad to begin followed by 2 tone beep	illuminate Touch the Keypad to begin
Enter the master code, followed by # key		2 tone beep	If you have forgotten the master code please see the resetting the lock section of the manual.
Press the [4] button followed by # key		2 tone beep after each button pressed	You are now in the lock's menu, option 4 contains the home automation settings
Press the [3] button followed by the hash key		3 tone ascending beep	This will disconnect the lock from the previous system

Opening the lock with a PIN code



Step	Icon	Expected Feedback	Description
Touch the Keypad with the palm of your hand		Keypad will illuminate followed by 2 tone beep	Touch the Keypad to begin
Enter a valid user code followed by the * key		3 tone ascending beep	If you have forgotten the master code please see the resetting the lock section of the manual.
Open the Door			Turn the Thumb turn to open the door.



Opening the lock with an Key Card/Tag

Step	Icon	Expected Feedback	Description
Present a valid key card or tag to the lock.		3 tone ascending beep	The Thumb turn is now engaged and will allow you to open the door.
Open the Door			Turn the Thumb turn to open the door.

Opening the lock with a Remote Fob



Step	Icon	Expected Feedback	Description
Press any button on a registered Remote fob		3 tone ascending beep	The Thumb turn is now engaged and will allow you to open the door.
Open the Door			Turn the Thumb turn to open the door.

Security Features

Intrusion Alarm

Damage Alarm :
If the circuit board of outer handle is damaged the alarm will sound.

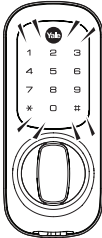

Security Features

Incorrect PIN Lockout

For security if the wrong PIN is entered 5 consecutive times the lock will lockout for 3 minutes. This is indicated by the number 3 on the keypad flashing.

To Release Lockout

- Method
- 1 Press the [R] button inside of battery cover.
 - 2 Press any Remote fob button

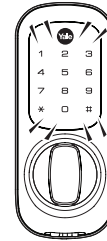





Emergency Power

Emergency Power Supply for Discharged Batteries

If the batteries in the lock have completely failed emergency power can be provided by a 9V battery on the front body.

To Supply Emergency Power

Step	Icon	Description
Contact the 9V battery		Place 9V battery onto the emergency power supply terminal
Touch the keypad with the palm of your hand		
Enter PIN code		Enter the registered PIN code in the keypad.
Press Enter button		Press * button to activate the outer handle.

Expiry Period

The product uses four 1.5V(LR6) alkaline AA batteries. The batteries will last approximately 1 year based on the lock being used 10 times a day. (Users are advised to use authentic alkaline batteries.)

Low Battery Alarm

You must replace all 4 batteries for the following cases:

- * The Low Battery indicator on the front of the lock illuminates
- * The Host connected system indicates a low battery in the lock

RISK OF EXPLOSION IF BATTERY IS REPLACED BY AN INCORRECT TYPE. DISPOSE OF USED BATTERIES ACCORDING TO THE WASTE BATTERIES REGULATIONS.



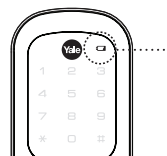

Low battery lamp (red)



The battery life varies according to ambient temperature, humidity, frequency of use and the quality of the battery. Do not use rechargeable batteries. Only alkaline batteries are recommended.

Resetting the Lock

In the event of losing the master code to the lock, the lock will need to be reset back to factory default settings. This will mean that all previously configured user codes, remote fobs, key cards/tags, and home automation systems will stop working. It will also result in the master code being set to the factory default which is '123456'

Step	Icon	Description
Remove inside cover		Press the two release buttons to remove the cover of the lock on the inside of the door.
Remove a battery from inside the lock. Then remove the module.		Take out any battery to remove the power from the lock.
Press and hold the [R] button, Continue holding the button and insert battery.		
The lock will beep 12 times followed by a 3 tone ascending beep		Continue holding these buttons until the ready sound is heard
Wait for 10 seconds, a two tone sound will be heard.		The master code is now set to 123456 and all codes, cards/tags and fobs are deleted.

Specifications

Specifications

Parts	Specifications	Remarks
Front (Front Body)	64mm(W)x 153mm(H) x 51mm(D) Zinc die-casting	Operating Temperature -15°C - 55°C (5-131° F)
Back(Main Body)	68mm(W)x 120mm(H) x 21mm(D) PC/ABS	Operating Temperature -15°C - 55°C (5-131° F)
Lever	Zinc die-casting	
Battery	4EA 1.5V AA alkaline batteries (Operating voltage 4.5~ 6V)	Lasts approximately 1 year (when lock is used 10 times a day)

* Battery life may vary depending on temperature, moisture levels frequency of use and the quality of the batteries.



WEEE Note:

Waste electrical products should not be disposed of with household waste. Please recycle where facilities exist. Check your local authority or retailer for recycling advice.



Guarantee



2 Year Guarantee Statement

This product is guaranteed for consumers against faulty workmanship, materials and function for a period of 2 years from the date of purchase providing the full installation and maintenance instructions are followed. Please keep your proof of purchase safe, this must be submitted when making a claim under this guarantee.

Please note that it is a condition of this guarantee that your Yale product:

- Has been correctly installed and maintained in accordance with the Yale installation and maintenance instructions provided to you at the time of purchase.
- Has not been modified or damaged in any way
- Has not been subject to any unauthorised repairs.

Yale installation and maintenance instructions provided to you at the time of purchase. Yale are responsible under this guarantee for repairing the product or replacing the product as we deem necessary. If there is fault with the product, please contact Customer Services on 01902 364606, who will give you the name of an expert and will confirm what you need to make a claim under this guarantee.

Please do not carry out any repairs without our authority or by using an unauthorised expert. Any repairs or other works carried out without our authorisation or by using an authorised expert will not be covered under this guarantee.

This guarantee is non transferable and applies to products purchased in the United Kingdom only. This guarantee does not apply to normal wear and tear. This does not affect your statutory rights. A full copy of this guarantee is available upon request by writing to Yale UK, School Street, Willenhall, West Midlands. WV13 3PW or by visiting our website www.yale.co.uk.

Register Your Guarantee Online

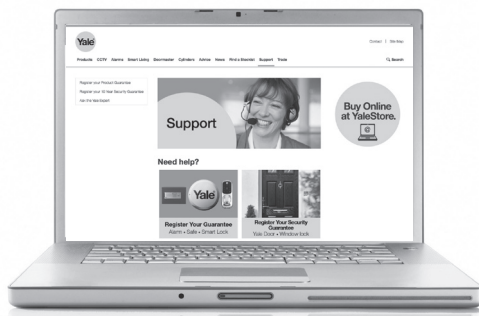

www.yale.co.uk/en/yale/couk/support/

User Code Log

Pin Codes

Slot Number	Name	Pin Code (Optional)
1		
2		
3		
5		
6		
7		
8		
9		
10		
11		
12		
13		
14		
15		
16		
17		
18		
19		
20		

User Key Card/Tag Log

Pin Codes

Slot Number	Name	Pin Code (Optional)
1		
2		
3		
5		
6		
7		
8		
9		
10		
11		
12		
13		
14		
15		
16		
17		
18		
19		
20		

Remote fob Log

Remote fob

Slot Number	Name
1	
2	
3	
4	
5	



Customer Service Helpline

At Yale, we know the importance of providing security products that are easy to install and use.

However, should you have any questions or experience a problem with your purchase, please contact our Customer Service Helpline.

Tel: 01902 364606
Monday – Friday 8.30am – 5.30pm
Email: info@yale.co.uk

PLEASE CALL US BEFORE CONTACTING YOUR RETAILER.



YaleUK



YaleSecurity



YaleSecurityUK

The smarter way to protect your home.