

## Seating Price List **2019**











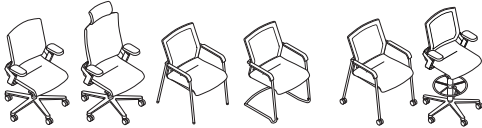





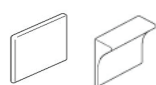

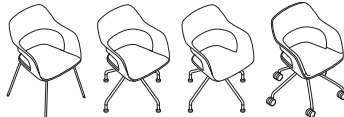



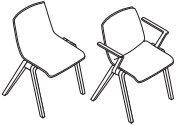
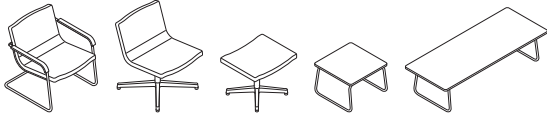

Sitzbock

**Contents by range**

170 range - ON® with Trimension®			5
180 range			19
184 range - IN			27
186 range - Metrik			33
187 range - AT			37
20 range - Stitz 2			47
204 range Sitzbock		<b>New</b>	49
208 range Landing		<b>New</b>	51
21 range - FS-Line			53
21 range - FS Management			61
222 range - Occo & Occo SC	 <b>New</b> 		63
230 range			77
230 S range			85

**Contents by range**

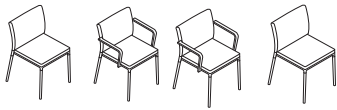
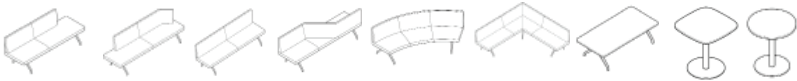
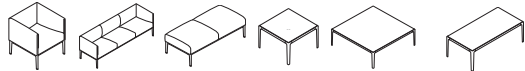
238 range - Aula		89
249 range - Cura		95
27 range - Modus Compact		105
28 range - Modus Medium		109
28 range - Modus Executive		111
295 range - Intra		<b>New</b> 115
30 range - Graph		119
340 range - Chassis		126
361 range - Ceno		130
780 range - Insit		<b>New</b> 136
860 range - Asienta		150
Fabric grades		157
Finishes		173
Standard Lead Times		182
Terms and Conditions		183



## Wilkhahn & sustainability

With over 100 years of corporate history, Wilkhahn can look back on a sustainability philosophy that has grown over decades. Terms such as longevity, social fairness, environmental responsibility and cultural orientation have developed into guiding corporate principles since the 1950s. Today Wilkhahn is internationally regarded as a model of excellence not only on account of its products but also due to its modern corporate philosophy. This philosophy stems from the early awareness that a corporate culture with a long-term focus should incorporate environmental aspects, as well as the improvement of social relations and the development of a company's cultural role in society. This understanding of corporate activities creates a bond between us and our customers throughout the world. There is surely no more rewarding task than working together for a successful future that is worth living in.

## Corporate principles

### Truthfulness in product design

We strive to develop lasting products, increase their utility value and reduce waste. "Less is more" or "reduce to the max" are the guiding principles that Wilkhahn continually translates into future contexts. Ecologically oriented design principles are a natural, integral part of our product development.

### Fairness in cooperation

We focus on people. At Wilkhahn this applies to employees, business partners and customers. It means to analyze, to inform, educate and sustainably support through the entire Project. Internally we exercise a cooperative style of management that recognizes employees' representatives as being co-managers who participate in shaping the company.

### Ecological responsibility

Wilkhahn pursues the goal of sustainable development. Wilkhahn's corporate culture is shaped by the balance that we strive to achieve between economic, ecological, social and cultural objectives for safeguarding the independence of the company. Adherence to environmentally relevant criteria throughout the entire product life cycle forms the basis on which we judge our success.

### Employees as partners

As an outperforming organization that is able to identify commercial opportunities, we see our employees as partners. This includes outstanding benefits, team work and an excellent project development. All employees are financially rewarded for their accomplishments and participation in the company's success. The employee's workplace is defined by future oriented developments guided through pioneering steps in the workplace environment where social, ecological, economic and aesthetic needs are combined to find common grounds.

## Sustainability policy

### UN Global Compact

Wilkhahn joined the United Nations Global Compact initiative in 2007. This self-commitment statement contains the ten principles of the Global Compact regarding the protection of international human rights, adherence to labor standards and rights for employees, the protection of the environment and anti-corruption which are laid down as binding corporate policy.



WE SUPPORT

### Management systems ISO 9001:2008 quality management system

In order to safeguard and continually optimize the high quality of products and processes, a comprehensive quality management system was set up at Wilkhahn's headquarter as early as 1996 which has since been certified in accordance with the ISO 9001 Quality Management Standard of the International Standardization Organization. Quality management concentrates on customer focus, management responsibility, the participation of all employees involved, process safety and its continuous improvement, transparent decision-making structures and supplier relations.



### ISO 14001:2009

In addition, is certified in accordance with ISO 14001, the international Environmental Management Standard which sets out internationally recognized specifications for an environmental management system, such as reducing ecological footprints and evaluating environmental data and environmental performance.

## EMAS

EMAS is the acronym for Eco-Management and Audit Scheme, developed by the EU. As a combined environmental management and auditing system, its purpose is to verify that companies are improving their environmental performance. Wilkhahn became one of the first companies in Lower Saxony to be certified to comply with the new version of EMAS III. In the environmental declaration, confirmed by annual audits, Wilkhahn gives a public account of the company's environmental performance. For detailed and up-to-date information on Wilkhahn's socio-ecological approach, go to [www.wilkhahn.com/en-us](http://www.wilkhahn.com/en-us)



EMAS

VERIFIED  
ENVIRONMENTAL  
MANAGEMENT  
D-133-00055

## Product certifications

Wilkhahn office ranges are not only certified according to internationally relevant testing and inspecting standards regarding product safety and functional integrity, but they also meet all important international reference systems for promoting health and environmentally friendly products.

### GREENGUARD™

Virtually all Wilkhahn products undergo testing and certification in accordance with GREENGUARD. The Greenguard Environmental Institute is an independent institution in the US that certifies products with regards to their suitability for interiors. Besides environmental aspects, special focus is on ensuring that products do not emit any pollutants that might be harmful to health.



## LEED

Leadership in Energy and Environmental Design (LEED) is a rating system used by the US Green Building Council to evaluate the environmental and social compatibility of buildings. LEED certification awards extra credit points if Wilkhahn office chair and table ranges are used.



## Responsibility from the very start

In the design and development process, alongside the design, functional and business related aspects Wilkhahn already considers the ecological impacts are already the ecological impact right from the start. For this is where the most important factors are determined that set the course for selection of materials, manufacturing processes, options for assembly, logistics and transport, repairability and recyclability. This overview shows the key aspects for the entire product life cycle that are currently applicable at Wilkhahn.

## Materials

Materials used are subject to stringent control. Prohibited and hazardous chemicals are not used in our products. With the primary goal to achieve maximum durability and quality Wilkhahn uses recycled materials, in particular metals like steel and aluminum, to manufacture its products.

## Production

### Water conservation, waste management and sustainable energy production

Water is becoming an increasingly important resource. Wilkhahn spares no effort in minimizing water consumption in all areas. By treating process water, recycling and using state-of-the-art varnishing machinery, no waste water is produced that requires monitoring. The Wilkhahn waste management concept includes sorting and recycling waste according to same materials and contents. The continual decrease in energy

consumption is an important goal of the environmental management system. A combined heat and power plant and connection to a biogas plant at the Bad Münden site has more than doubled energy efficiency. As a result, heating at the head-quarters and production facilities is CO2 neutral.

## Wilkhahn's own production sites

Wilkhahn products are manufactured and assembled in Bad Münden (Germany) and Sydney (Australia). The branch facilities and international subsidiaries are not only subject to quality management requirements, but also to socio-ecological guidelines of the corporate policy which are applied throughout the entire company.

## Product Use

### Aesthetics and design

Products are sustainable if they serve a purpose. The timeless design of the Wilkhahn product range means they are useful, intuitive to operate and the materials used exhibit enduring quality. A standard that is reflected by every single detail. The Wilkhahn design approach therefore leads to an increase in utility that is meant to last.

### Longevity and guarantee

The product ranges set standards for design that is "sustainable" in the most optimal way. The durability of the high-quality materials used, the innovative functional concepts and the classic, understated design guarantee usability for many decades. We offer a five-year manufacturers' guarantee. Our service in terms of "ecological prolongation of service life" includes general overhauling and maintenance of products from older ranges. Wilkhahn offers repair service for furniture units no longer produced for two further years following discontinuation. undergo certification in the USA in accordance with GREENGUARD Indoor Air Quality™. GREENGUARD™ is a certification

## Air quality and emissions of pollutants

Virtually all Wilkhahn products programme for low-emission products.

## End of product life cycle Disassembly and recycling

Most components permit non-destructive disassembly. Any components weighing more than 5.3oz. bear a material identification mark to ensure that materials can be sorted according to their type. No material protecting agents or halogen organic combinations are used that prevent subsequent recycling. Due to the clear marking and identification of all materials, we can ensure that the components of a Wilkhahn product are returned to both central and local material and production cycles are properly recycled and, if necessary, disposed of.

For further information please contact [sales@wilkhahn.com](mailto:sales@wilkhahn.com)

## 170 range

### ON® with Trimension®

Design: wiege



#### Technical Details

##### Function

Task chairs with Trimension®, synchronous, three-dimensional kinematics that encourages three-dimensional dynamic sitting. The coordinated interaction of mechanics, seat and back automatically adapts to the user – whatever the posture or motion involved. The supporting counterpressure is quickly and adjustable in any direction (a max. of 4.5 rotations) in a weight range of 99–264 lb. Backrest height adjustable by up to (2<sup>3</sup>/<sub>8</sub>"") in six lockable positions. Backrest and seat can be locked in the front sitting position. The seat height is infinitely adjustable between 15<sup>3</sup>/<sub>4</sub>" and 20<sup>1</sup>/<sub>2</sub>" with a DIN 4550-compliant gas lift. All models optionally available with seat depth adjustment of 15<sup>3</sup>/<sub>4</sub>" – 17<sup>3</sup>/<sub>4</sub>".

Conference and visitor chairs with Trimension, on request with non height-adjustable pivoting column, alternatively as four-legged type or cantilever chair, optionally stackable.

##### Frame

###### Task and counter chairs

Five-star base, optionally with black, through-dyed plastic, or die-cast aluminum, powder coated (black or black textured matte finish), or silver (silver satin finish), polished or bright chrome. Twin wheel swivel castors with load-dependent braking, made of black polyamide compliant with DIN EN 12529 as the standard version for carpets; with gray polyurethane tire for hard floors. Castors optionally electrically conductive. Mechanism cover made of die-cast, shot-blasted aluminum, optionally powder coated in black or silver satin finish, with top cover made of black, through-dyed polypropylene. Gas lift covered by telescopic protective tube made of black through-dyed polypropylene.

Counter stool with extra height-adjustable foot ring, bright chrome-plated, with lock screw to affix it and twin wheel swivel castors with load-dependent braking.

###### Visitor / conference chairs

Four-star, die-cast aluminum base, powder coated (black or silver satin finish), matte polished or bright chrome-plated. Black, multi-purpose plastic glides for all types of flooring. Swivel plates made of die-cast aluminum, powder coated (black or silver satin finish), polished or bright chrome-plated. Mechanism cover made of die-cast, shot-blasted aluminum, optionally powder coated in black or silver satin finish, with top cover made of black, through-dyed polypropylene. Gas lift covered by telescopic protective tube made of black through-dyed polypropylene.

###### Cantilever chairs

Frame made of bright, chrome plated steel tube, <sup>7</sup>/<sub>8</sub>" in diameter, with anti-tilt stoppers made of black Polyamide in the standard version for carpets, optionally with hard polyamide glides for soft floors, soft polyurethane glides for hard floors, or Polyamide glides with additional felt insert (e.g. for wooden or stone floors susceptible to scratches). Small plastic parts black through-dyed.

###### Four-legged visitor chairs

Frame made of bright chrome-plated steel tube, legs <sup>7</sup>/<sub>8</sub>" in diameter, with black polyamide glides in the standard version for carpets, optionally with soft polyurethane glides for hard floors, or polyamide glides with additional felt insert (e.g. for wooden or stone floors susceptible to scratches). Small plastic parts black through-dyed.

##### Seat

###### Task, visitor and conference chairs

Highly elastic, flexibly suspended seat shell with seat upholstery panel made of black, through-dyed polypropylene, polyurethane seat cushion covered in the same material as the backrest cover in Fiberflex, or fabric. Seat can be exchanged. In models with fully upholstered seat and back (174/71, 175/71, 171/71, 172/71) seat cushion with extra padding and side facings, optionally also in leather.

## Back

### Task, visitor and conference chairs

Elastic back frame, height adjustable by 2<sup>3</sup>/<sub>8</sub>" in six lockable positions, made of through-dyed, reinforced fiberglass polyamide, covered with Fiberflex, optionally also with fabric (with additional padding). In models with fully upholstered seat and back (models 174/71, 175/71) back frame optionally with back cushion too. Backrest upholstery with additional padding, front of backrest also with concealed, cut foam fleece sewn into the cover and with side facings, optionally with leather cover. Medium-high and high back rest, high backrest optionally with headrest (height 6<sup>1</sup>/<sub>4</sub>" ), either in the same material as the backrest cover, or covered in leather on the front. Back can be exchanged.



## Seat and back

### Cantilever / four-legged visitor chairs

Unitary shell-frame design made of through-dyed, reinforced fiberglass polypropylene. Seat cushion made of polyurethane moulded foam, in models with fully upholstered seat and back (models 176/71, 178/71) with additional padding and side facings.

In models 176/7, 178/7 seat cushions covered in the same material as the backrest cover in Fiberflex or fabric, models 176/71 and 178/71 with fully upholstered seat and back or in leather. Seat can be exchanged. Back frame covered in Fiberflex, in models 176/7, 178/7 back optionally covered in fabric. Models with fully upholstered seat and back (176/71 and 178/71) optionally with back cushion in fabric or leather, with additional padding, front of backrest also with concealed, cut foam fleece sewn into the cover and side facings, back cover exchangeable.



## Armrests

### Task chairs

3D armrests made of reinforced fiberglass, black through-dyed polyamide. Armrest pads made of black through-dyed polyurethane (TPU) optionally also made of polyurethane foam and covered in leather depending on customer preference. Armrest covers made of black, through-dyed polypropylene. Height of armrests adjustable by 3<sup>7</sup>/<sub>8</sub>" (eight lockable positions), depth by 1<sup>5</sup>/<sub>8</sub>" , in each case can be swivelled 30° inwards and outwards.

### Visitor / conference chairs

Rigid armrests made of reinforced fiberglass, black, through-dyed polyamide. Armrest pads made of black, through-dyed polyurethane (TPU), optionally also made of polyurethane foam and covered in leather depending on customer preference. Armrest covers made of black, through-dyed polypropylene.

### Cantilever / four-legged visitor chairs

Armrest pads made of black, through-dyed polypropylene. In non-stackable chairs, optionally with upholstered armrests, when covered in fabric with black leather 74/99, when covered in leather according to the colour of the leather.

### Standards

The ON swivel, visitor and conference chairs comply with office chair standard DIN EN 1335, type A or B,

of ANSI/BIFMA X 5.1. If required also available and compliant with NPR 1813. The ON cantilevers and four-legged visitor chairs comply with DIN EN 13761 and DIN EN 1022. The ON four-legged swivel and cantilever chairs qualify for the GS symbol.

Most of the ON range complies with CAL133 standards. Pricing upon request.

IGR/ AGR certified 12/2018



**Optionally, the ON swivel, visitor and conference chairs (without headrest) can also be shipped with dismantled backrests in boxes.**

**All visitor and conference chairs have hard glides for soft flooring (e.g. carpets). Available with pivoting column, not height adjustable (at no extra cost).**

### Accessories

Optional for visitor chair, model 176/7: inline connectors, model 177 made of zinc-plated steel, two-wheeled cart, model 176 for 8 visitor chairs.

Optional for cantilever, model 178/7, four-wheeled trolley, model 178 for 8 cantilevers.

## Fabric Grades

**Grade 3 = 35** Fiberflex

**Grade 4 = 47** Nova

**Grade 5 = 54** Pitch

**Grade 6 = 60** Blend

**62** Bond

**63** Auris

**66** Lona

**68** Remix 2

**69** Granit

**Grade 9 = 91** Kvadrat  
Steelcut Trio 3

**Skai Faux Leather**

**Leather = 74**

**Leather = 87**



## GREENGUARD™

Virtually all Wilkhahn products undergo testing and certification in accordance with GREENGUARD. The Greenguard Environmental Institute is an independent institution in the US that certifies products with regard to their suitability for interiors. Besides environmental aspects, special focus is on ensuring that products do not emit any pollutants that might be harmful to health.



**ON® with Trimension®  
Dimensions**

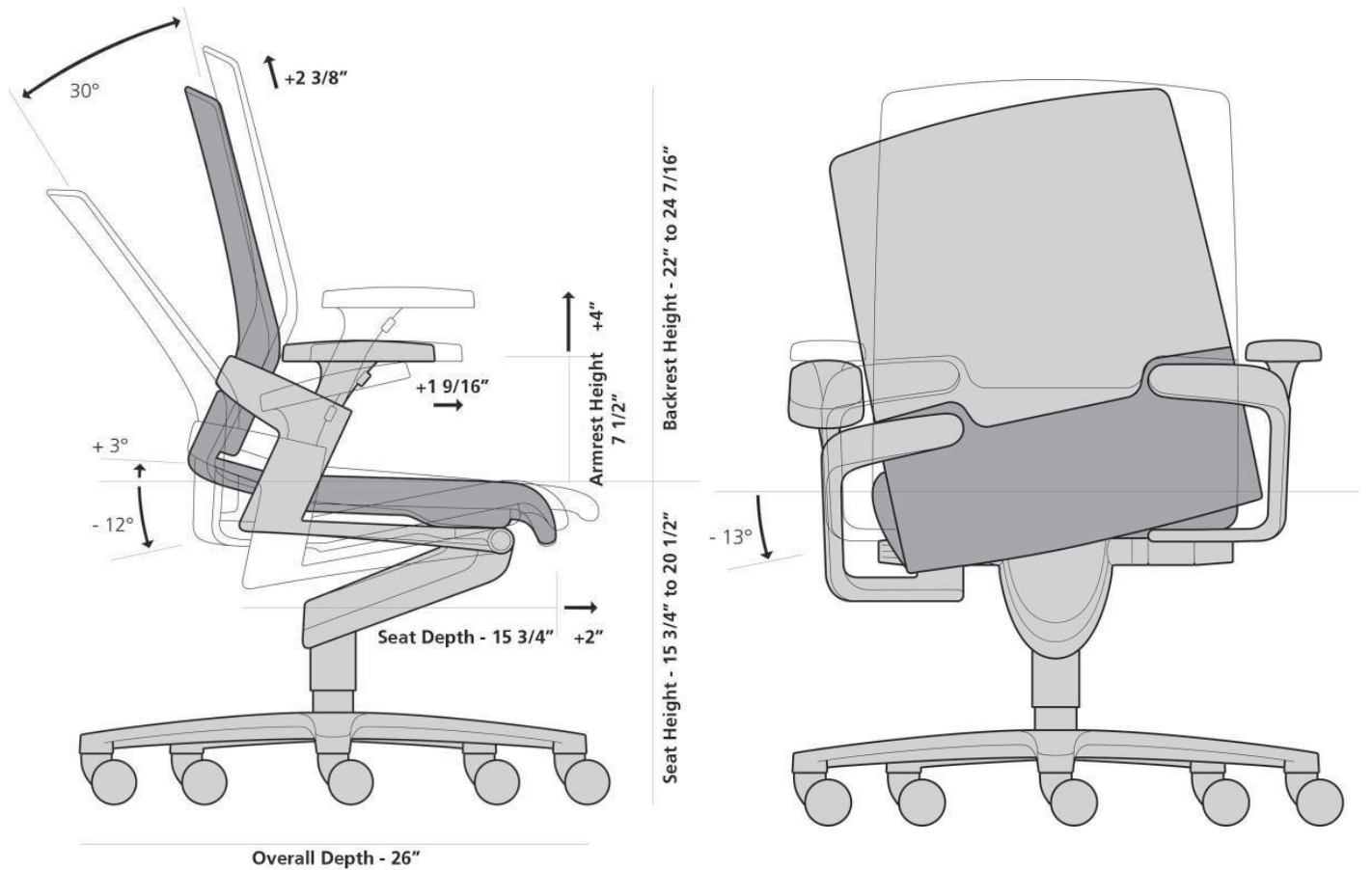
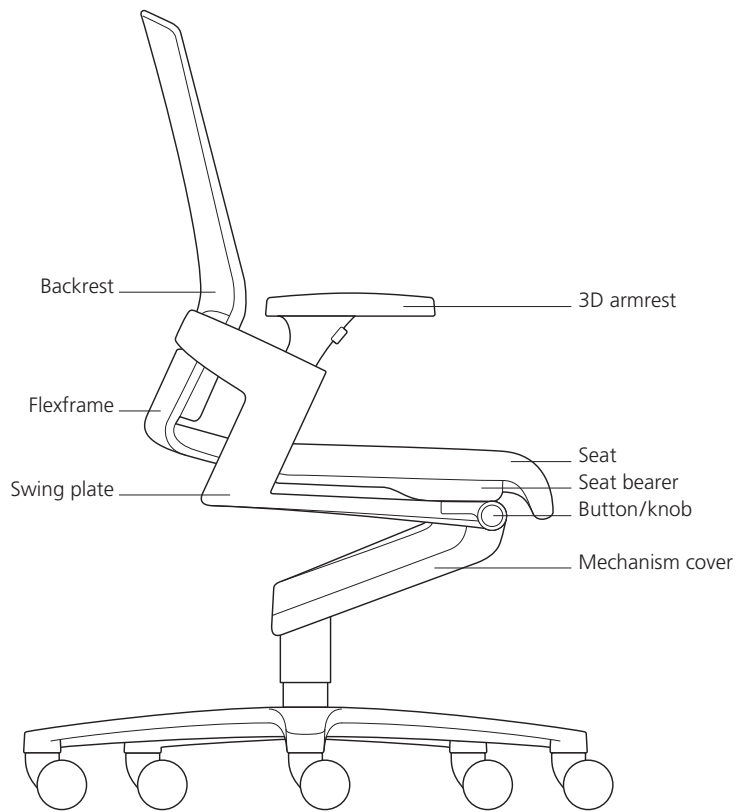

**Task chair Medium-height backrest**



Seat height **15 3/4"-20 1/2"**  
 Overall Height **38 1/4"-42 7/8"**  
 Overall Width **27 1/8"**  
 Overall Depth **26"**

**Visitor chair Standard height backrest**

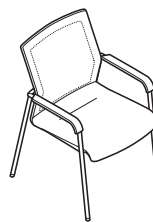

Seat height **16 7/8"**  
 Overall Height **35 3/8"**  
 Overall Width **25 1/4"**  
 Overall Depth **25 1/4"**

**Task chair High backrest**



Seat height **15 3/4"-20 1/2"**  
 Overall Height **41 3/8"-46 1/8"**  
 Overall Width **27 1/8"**  
 Overall Depth **26"**

**Visitor chair Standard height backrest on castors**

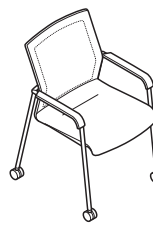

Seat height **16 7/8"**  
 Overall Height **35 3/8"**  
 Overall Width **25 1/4"**  
 Overall Depth **25 1/4"**

**Task chair High backrest with headrest**

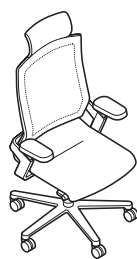

Seat height **15 3/4"-20 1/2"**  
 Overall Height **48 3/8"-53 1/8"**  
 Overall Width **27 1/8"**  
 Overall Depth **26"**

**Cantilever chair Standard height backrest**

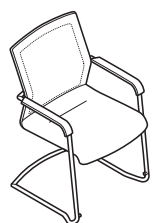

Seat height **16 7/8"**  
 Overall Height **36 1/4"**  
 Overall Width **24"**  
 Overall Depth **23 5/8"**

**Counter-height stool**

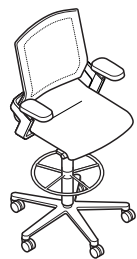

Seat height **26 3/4"-32"**  
 Overall Height **49 1/4"-54 3/8"**  
 Overall Width **27 1/8"**  
 Overall Depth **26"**

**Trolley with 8 stacked cantilever chairs**

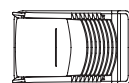

Overall Height **58"**  
 Overall Width **26"**  
 Overall Depth **40"**

**Dolly with 8 stacked visitor chairs**

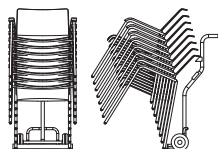

Overall Height **52"**  
 Overall Width **26"**  
 Overall Depth **47"**



ON® task chair

**ON® with Trimension®  
Task chairs**

Upholstery material

**Features**

Trimension tension control  
Pneumatic height adjustment  
Adjustable backrest height

COM	Fiberflex grade 3	Fabric grade 4	Fabric grade 5	Fabric grade 6 *	Fabric grade 9
USD	USD	USD	USD	USD	USD

**174/7 Medium-height backrest - Fixed seat with arms**



**base Plastic / swing plates Powder Coated <sup>1</sup>**

seat Fiberflex, back Fiberflex  
seat Fabric, back Fiberflex  
seat Fabric, back Fabric

-	1792	-	-	-	-
1934	-	1920	1948	1977	2022
2142	-	2105	2178	2235	2323

**base Matte Polished Aluminum / swing plates Matte polished aluminum**

seat Fiberflex, back Fiberflex  
seat Fabric, back Fiberflex  
seat Fabric, back Fabric

-	2150	-	-	-	-
2292	-	2278	2306	2335	2380
2500	-	2463	2536	2593	2681

**base Bright Chrome Aluminum / swing plates Bright Chrome**

seat Fiberflex, back Fiberflex  
seat Fabric, back Fiberflex  
seat Fabric, back Fabric

-	2594	-	-	-	-
2736	-	2722	2750	2779	2824
2944	-	2907	2980	3037	3125

**Additional upcharge for extra backrest cushioning**

extra backrest cushioning adding 3/4" of soft padding

173	209	251	282	332
-----	-----	-----	-----	-----

<sup>1</sup> Powder Coat colors: Silver or Black

\* Not available in Skai faux leather

**Additional charges/reduced prices specific to range**

		USD
<b>Frame:</b>	1. a) base Powder Coated <sup>1</sup>	190
<b>Armrests:</b>	1. a) armrest pad in Black Polyurethane Foam; or b) without armrests	119 -142
<b>Other:</b>	1. a) anti-static castors	95
	2. a) CAL133 compliant charge (applies only to certain models and finishes and not in combination with Fiberflex fabric. Please ensure textiles meet all appropriate flammability requirements)	211
	3. a) seat depth adjustment	180
	4. a) extra seat cushioning adding 3/4" of soft padding (with Fiberflex upholstery only)	no additional charge

**COM/COL Requirements (174/7)**

	COM (yd)	COL (sq.ft.)
Seat only	1	*
Seat and back	1.5	*
Seat, back and headrest (175/7 only)	1.5	*

\* For COL please refer to 174/71 & 175/71 models for pricing.

COM yardage and COL square footage requirements may differ from standard requirements due to leather types and/or fabric patterns. The ultimate yardage/square footage will be determined at time of testing. Please refer to Terms and Conditions for COM/COL terms.

All swivel chairs are fitted with hard castors for soft floors (e.g. carpet). For hard floors (e.g. stone, wood), please specify soft castors when ordering (no additional charge).  
Additional charge for anti-static castors (in combination with aluminum frame).

**ON® with Trimension®**  
**Task chairs**

Upholstery material

**Features**

Trimension tension control  
 Pneumatic height adjustment  
 Adjustable backrest height

COM	Fiberflex grade 3	Fabric grade 4	Fabric grade 5	Fabric grade 6 *	Fabric grade 9
USD	USD	USD	USD	USD	USD

**175/7 High backrest - Fixed seat with arms**



**base Plastic / swing plates Powder Coated <sup>1</sup>**

seat Fiberflex, back Fiberflex	-	2249	-	-	-
seat Fabric, back Fiberflex	2391	-	2377	2405	2434 2479
seat Fabric, back Fabric	2632	-	2593	2670	2754 2877

**base Matte Polished Aluminum / swing plates Matte polished aluminum**

seat Fiberflex, back Fiberflex		2607	-	-	-
seat Fabric, back Fiberflex	2749	-	2735	2763	2792 2837
seat Fabric, back Fabric	2990	-	2951	3028	3112 3235

**base Bright Chrome Aluminum / swing plates Bright Chrome**

seat Fiberflex, back Fiberflex		3051	-	-	-
seat Fabric, back Fiberflex	3193	-	3179	3207	3236 3281
seat Fabric, back Fabric	3434	-	3395	3472	3556 3679

**Additional upcharge for extra backrest cushioning**

extra backrest cushioning adding 3/4" of soft padding	206	235	289	351	441
---	-----	-----	-----	-----	-----

<sup>1</sup> Powder Coat colors: Silver or Black

\* Not available in Skai faux leather

**Additional charges to the chair model**

armrests in Leather	422
headrest addition in same material as backrest	164
headrest addition in Leather on the front	265

**Additional charges/reduced prices specific to range**

		USD
<b>Frame:</b>	1. a) base Powder Coated <sup>1</sup>	190
<b>Armrests:</b>	1. a) armrest pad in Black Polyurethane Foam; or b) without armrests	119 -142
<b>Other:</b>	1. a) Anti-static castors	95
	2. a) CAL133 compliant charge (applies only to certain models and finishes and not in combination with Fiberflex fabric. Please ensure textiles meet all appropriate flammability requirements)	211
	3. a) seat depth adjustment	180
	4. a) extra seat cushioning adding 3/4" of soft padding (with Fiberflex upholstery only)	no additional charge

**COM/COL Requirements (175/7)**

	COM (yd)	COL (sq.ft.)
Seat only	1	*
Seat and back	1.5	*
Seat, back and headrest (175/7 only)	1.5	*

\* For COL please refer to 174/71 & 175/71 models for pricing.

COM yardage and COL square footage requirements may differ from standard requirements due to leather types and/or fabric patterns. The ultimate yardage/square footage will be determined at time of testing. Please refer to Terms and Conditions for COM/COL terms.

**ON® with Trimension®**  
**Task chairs with with management upholstery**

Upholstery material

**Features**

Trimension tension control  
 Pneumatic height adjustment  
 Adjustable backrest height

COM	COL	Fabric grade 6 / Skai faux leather	Fabric grade 9	Leather 74	Leather 87
USD	USD	USD	USD	USD	USD

**174/71 Medium-height backrest - Fixed seat with arms**



**base Plastic / swing plates Powder Coated <sup>1</sup>**

seat Management, back Fiberflex  
 seat Management, back Management

**base Matte Polished Aluminum / swing plates Matte polished aluminum**

seat Management, back Fiberflex  
 seat Management, back Management

**base Bright Chrome Aluminum / swing plates Bright Chrome**

seat Management, back Fiberflex  
 seat Management, back Management

2076	2387	2041	2110	2337	2761
2756	3252	2669	2842	3202	3896
2434	2745	2399	2468	2695	3119
3114	3610	3027	3200	3560	4254
2878	3189	2843	2912	3139	3563
3558	4054	3471	3644	4004	4698

<sup>1</sup> Powder Coat colors: Silver or Black

**Additional charges to the chair model**

armrests in Leather

422	422	422	422	422	479
-----	-----	-----	-----	-----	-----

**Additional charges/reduced prices specific to range**

**USD**

<b>Frame:</b>	1. a) base Powder Coated <sup>1</sup>	190
<b>Armrests:</b>	1. a) armrest pad in Black Polyurethane Foam; or b) without armrests	119 -142
<b>Other:</b>	1. a) anti-static castors	95
	2. a) CAL133 compliant charge (applies only to certain models and finishes and not in combination with Fiberflex fabric. Please ensure textiles meet all appropriate flammability requirements)	211
	3. a) seat depth adjustment	180

**COM/COL Requirements (174/71)**

**COM (yd)**

**COL (sq.ft.)**

Seat only	1	10
Seat and back	1.5	28.5
Armrests	N/A	3

COM yardage and COL square footage requirements may differ from standard requirements due to leather types and/or fabric patterns. The ultimate yardage/square footage will be determined at time of testing. Please refer to Terms and Conditions for COM/COL terms.

All swivel chairs are fitted with hard castors for soft floors (e.g. carpet). For hard floors (e.g. stone, wood), please specify soft castors when ordering (no additional charge).  
 Additional charge for anti-static castors (in combination with aluminum frame).

**ON® with Trimension®**  
**Task chairs with management upholstery**

Upholstery material

**Features**

Trimension tension control  
 Pneumatic height adjustment  
 Adjustable backrest height

COM	COL	Fabric grade 6 / Skai faux leather	Fabric grade 9	Leather 74	Leather 87
USD	USD	USD	USD	USD	USD

**175/71 High backrest - Fixed seat with arms**



**base Plastic / swing plates Powder Coated <sup>1</sup>**

seat Management, back Fiberflex	2327	2908	2292	2361	2858	3012
seat Management, back Management	3060	3832	2970	3150	3782	4209

**base Matte Polished Aluminum / swing plates Matte polished aluminum**

seat Management, back Fiberflex	2685	3266	2650	2719	3216	3370
seat Management, back Management	3418	4190	3328	3508	4140	4567

**base Bright Chrome Aluminum / swing plates Bright Chrome**

seat Management, back Fiberflex	3129	3710	3094	3163	3660	3814
seat Management, back Management	3862	4634	3772	3952	4584	5011

<sup>1</sup> Powder Coat colors: Silver or Black

**Additional charges to the chair model**

armrests in Leather	-	422	422	422	422	479
headrest addition in same material as backrest	-	171	254	171	171	277
headrest addition in Leather on the front	-	254	-	254	254	-

**Additional charges/reduced prices specific to range**

		USD
<b>Frame:</b>	1. a) base Powder Coated <sup>1</sup>	190
<b>Armrests:</b>	1. a) armrest pad in Black Polyurethane Foam; or b) without armrests	119 -142
<b>Other:</b>	1. a) Anti-static castors	95
	2. a) CAL133 compliant charge (applies only to certain models and finishes and not in combination with Fiberflex fabric. Please ensure textiles meet all appropriate flammability requirements)	211
	3. a) seat depth adjustment	180

**COM/COL Requirements (175/71)**

	COM (yd)	COL (sq.ft.)
Seat only	1	10
Seat and back	1.5	28.5
Armrests	N/A	3
Headrest	N/A	4

COM yardage and COL square footage requirements may differ from standard requirements due to leather types and/or fabric patterns. The ultimate yardage/square footage will be determined at time of testing. Please refer to Terms and Conditions for COM/COL terms.

## ON® with Trimension® Counter-height chair

### Features

Trimension tension control  
Pneumatic height adjustment  
Adjustable backrest height  
Footrest in Bright Chrome

	Upholstery material					
	COM	Fiberflex grade 3	Fabric grade 4	Fabric grade 5	Fabric grade 6 *	Fabric grade 9
	USD	USD	USD	USD	USD	USD

### 174/1 Counter-height stool

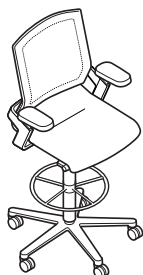

#### base Powder Coated / swing plates Powder Coated <sup>1</sup>

seat Fiberflex, back Fiberflex

2443 - - - -

seat Fabric, back Fiberflex

2585 - 2571 2599 2628 2673

seat Fabric, back Fabric

2793 - 2756 2829 2886 2974

#### base Matte Polished Aluminum / swing plates Matte polished aluminum

seat Fiberflex, back Fiberflex

2611 - - - -

seat Fabric, back Fiberflex

2753 - 2739 2767 2796 2841

seat Fabric, back Fabric

2961 - 2924 2997 3054 3142

#### base Bright Chrome Aluminum / swing plates Bright Chrome

seat Fiberflex, back Fiberflex

3055 - - - -

seat Fabric, back Fiberflex

3197 - 3183 3211 3240 3285

seat Fabric, back Fabric

3405 - 3368 3441 3498 3586

#### Additional upcharge for extra backrest cushioning

extra backrest cushioning adding 3/4" of soft padding

230 173 209 251 282 332

<sup>1</sup> Powder Coat colors: Silver or Black

\* Not available in Skai faux leather

### Additional charges/reduced prices specific to range

USD

<b>Armrests:</b>	1. a) armrest pad in Black Polyurethane Foam; or	119
	b) without armrests	-142
<b>Other:</b>	1. a) CAL133 compliant charge (applies only to certain models and finishes and not in combination with Fiberflex fabric. Please ensure textiles meet all appropriate flammability requirements)	211
	2. a) seat depth adjustment	180
	3. a) extra seat cushioning adding 3/4" of soft padding (with Fiberflex upholstery only)	no additional charge

### COM/COL Requirements (174/1)

COM (yd)

COL (sq.ft.)

Seat only	1	*
Seat and back	1.5	*
Seat, back and headrest (175/7 only)	1.5	*

\* For COL please refer to 174/1 & 175/1 models for pricing.

COM yardage and COL square footage requirements may differ from standard requirements due to leather types and/or fabric patterns. The ultimate yardage/square footage will be determined at time of testing. Please refer to Terms and Conditions for COM/COL terms.

All swivel chairs are fitted with hard castors for soft floors (e.g. carpet). For hard floors (e.g. stone, wood), please specify soft castors when ordering (no additional charge).  
Additional charge for anti-static castors (in combination with aluminum frame).

**ON®**  
**Conference/visitor and cantilever chairs**

Upholstery material

**Features**

Stackable 5-high free-standing  
 Stackable 8-high in cart or trolley

COM	Fiberflex grade 3	Fabric grade 4	Fabric grade 5	Fabric grade 6 *	Fabric grade 9
USD	USD	USD	USD	USD	USD

**176/7 Standard height backrest**

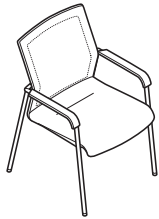

**frame Bright Chrome Aluminum**

seat Fiberflex, back Fiberflex  
 seat Fabric, back Fiberflex  
 seat Fabric, back Fabric

-	1055	-	-	-	-
1197	-	1183	1211	1240	1285
1405	-	1368	1441	1498	1586

**178/7 Standard height backrest**

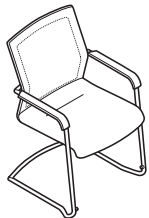

**frame Bright Chrome Aluminum**

seat Fiberflex, back Fiberflex  
 seat Fabric, back Fiberflex  
 seat Fabric, back Fabric

-	1147	-	-	-	-
1289	-	1275	1303	1332	1377
1497	-	1460	1533	1590	1678

**Additional upcharge for extra backrest cushioning**

extra backrest cushioning adding 3/4" of soft padding

230	173	209	251	282	322
-----	-----	-----	-----	-----	-----

**Additional charges specific to range**

		USD
<b>Armrests:</b>	1. a) armrests upholstered in Leather (not stackable)	422
<b>Other:</b>	1. a) CAL133 compliant charge (applies only to certain models and finishes and not in combination with Fiberflex fabric. Please ensure textiles meet all appropriate flammability requirements)	211

**Accessories**

	USD
177 Inline connector for model 176	83
176 Two-wheeled cart for 5 visitor chairs	1472
178 Four-wheeled trolley for 8 cantilever chairs	1522

**COM/COL Requirements (176/7 & 178/7)**

	COM (yd)	COL (sq.ft.)
Seat only	1	*
Seat and back	1.5	*

\* For COL please refer to 176/71 & 178/71 models for pricing.

COM yardage and COL square footage requirements may differ from standard requirements due to leather types and/or fabric patterns. The ultimate yardage/square footage will be determined at time of testing. Please refer to Terms and Conditions for COM/COL terms.

Conference/visitor and cantilever chairs with management upholstered seat and back

Upholstery material

Features	COM	COL	Fabric grade 6 / Skai faux leather	Fabric grade 9	Leather 74	Leather 87
	USD	USD	USD	USD	USD	USD

176/71 Standard height backrest



**frame Bright Chrome Aluminum**  
 seat Management, back Fiberflex  
 seat Management, back Management

1475	2052	1436	1514	2002	2156
2155	2917	2064	2246	2867	3291

178/71 Standard height backrest

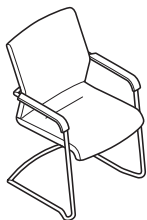

**frame Bright Chrome Aluminum**  
 seat Management, back Fiberflex  
 seat Management, back Management

1549	2126	1510	1588	2076	2230
2229	2991	2138	2320	2941	3365

\*Stackable version upon request.

**Additional charges to the chair model**  
 armrests in Leather (non-stackable)

422
-----

**Additional charges specific to range** **USD**

<b>Other:</b>	1. a) CAL133 compliant charge (not available in combination with Fiberflex fabric. Please ensure textiles meet all appropriate flammability requirements)	211
---------------	---	-----

**Accessories** **USD**

177 Inline connector for model 176	83
79599 Double stacking cushions	104

**COM/COL Requirements (176/71 & 178/71)** **COM (yd)**      **COL (sq.ft.)**

Seat only	1	9.5
Seat and back	1.5	27
Armrests	N/A	4

COM yardage and COL square footage requirements may differ from standard requirements due to leather types and/or fabric patterns. The ultimate yardage/square footage will be determined at time of testing. Please refer to Terms and Conditions for COM/COL terms.

Upholstery material

COM	Fiberflex grade 3	Fabric grade 4	Fabric grade 5	Fabric grade 6 *	Fabric grade 9
USD	USD	USD	USD	USD	USD

**176/8 Standard height backrest**

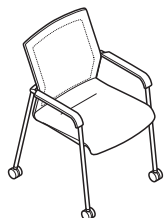

**frame Bright Chrome Aluminum**

seat Fiberflex, back Fiberflex  
 seat Fabric, back Fiberflex  
 seat Fabric, back Fabric

-	1152	-	-	-	-
1309	-	1292	1325	1356	1398
1516	-	1477	1555	1614	1699

COM	COL	Fabric grade 6 / Skai faux leather	Fabric grade 9	Leather 74	Leather 87
USD	USD	USD	USD	USD	USD

**176/81 Standard height backrest with management upholstered seat and back**

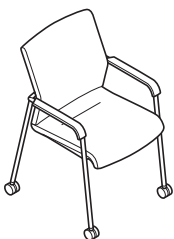

**frame Bright Chrome Aluminum**

seat Management, back Fiberflex  
 seat Management, back Management

1614	2245	1574	1652	2195	2361
2242	3110	2202	2384	3060	3496

\* Skai faux leather only available for model 176/81

**Additional charges specific to range**

		USD
<b>Armrests:</b>	1. a) armrests upholstered in Leather (not stackable) (model 176/8 only)	422
<b>Other:</b>	1. a) CAL133 compliant charge (applies only to certain models and finishes and not in combination with Fiberflex fabric. Please ensure textiles meet all appropriate flammability requirements)	211

**COM/COL Requirements (176/8 & 176/81)**

	COM (yd)	COL (sq.ft.)
Seat only	1	9.5*
Seat and back	1.5	27*
Armrests	N/A	4*

\* COL only available for model 176/81

COM yardage and COL square footage requirements may differ from standard requirements due to leather types and/or fabric patterns. The ultimate yardage/square footage will be determined at time of testing. Please refer to Terms and Conditions for COM/COL terms.



ON® task chairs

## 180 range

Design: wiege



### Technical Details

#### Function

Task chairs with automatic synchro-adjustment: the seat/backrest angle adjusts automatically to the sitting position of the user. When leaning back, the backrest tension increases according to the need for additional support. A crank handle allows infinitely variable tension adjustment for the user. Backrest position lockable in four different positions by engaging lever. Encapsulated gas lift, conforming to DIN 4550, for infinitely variable adjustment of seat height of swivel chairs. Adjustment of backrest height in six positions within a range of 2<sup>3</sup>/<sub>8</sub>" ; models with mesh membrane backrest have lumbar support adjustable within a range of 2<sup>3</sup>/<sub>8</sub>" instead of the height-adjustable backrest. All models feature adjustment of seat depth in eleven positions between 15<sup>1</sup>/<sub>8</sub>" – 17<sup>1</sup>/<sub>8</sub>". Models available with a mesh membrane backrest for task chair versions.

Cantilever chairs: chair, stackable up to 5-high, for visitors, meetings, conferences and seminars to match swivel chairs; with resilient, single-section seat shell, integral stacking buffer and outer rail/grip on the backrest. Model 183/3 with leather covering (74) and 183/5 not stackable.

#### Frame

**Task chairs**  
5-star base in reinforced fiberglass polyamide, through-dyed in black, or in die-cast aluminum matte polished, or bright chrome-plated. Twin wheel swivel castors with load-dependent braking, conforming to DIN EN 12529, as the standard version for carpeted floors, or with a gray polyurethane soft lining for hard floors (please specify when ordering).  
Anti-static castors on request (in combination with aluminum frame). Synchro-mechanism case in die-cast aluminum. Synchro-mechanism cover in black-gray through-dyed polypropylene. Seat bearer in reinforced fiberglass polyamide, through-dyed in black.

#### Counter chair

Star base from the ON 170 range, with additional height-adjustable foot ring, bright chrome-plated, with lock screw to affix it and twin wheel swivel castors with load-dependent braking.

#### Cantilever chairs

Frame in round steel tube, diameter 7/8", thickness 1/8", bright chrome-plated, with anti-tilt stoppers in black polyamide as the standard version for carpeted floors, optionally with glides in black-gray polyamide (for soft floors) or black-gray polyurethane (for hard floors), optionally with additional felt insert (please specify when ordering); outer rail/grip in die-cast zinc, bright chrome-plated.

#### Seat

##### Task chairs

Seat shell in polypropylene, through-dyed in black or white. Upholstery: covered, one-piece molded polyurethane foam with integral pelvic support, exchangeable. Adjustment of seat depth: on request, depth of seat platform individually adjustable from 15<sup>1</sup>/<sub>8</sub>" to 17<sup>1</sup>/<sub>8</sub>". The seat shifts in such a way that ensures that the angle of the pelvic wedge automatically adjusts to the position of the seat shell.

## Technical Details (continued)

### Back

#### Task chairs

Backrest shell in polyamide with back shell cover in polypropylene, through-dyed in black or white. Upholstery: covered, one-piece molded foam, exchangeable. Model 181/6 with backrest frame in reinforced fiberglass polyamide, in black, covered with semi-transparent, black, light-gray or white high-performance polyester; lower section of backrest frame covering in polypropylene, in black; optional lumbar support in polyamide, black through-dyed with integral foam overlay.

### Cantilever chairs

#### Seat and back

Single-section seat and back shell in resilient polypropylene, through-dyed in black or white. Seat cushion: exchangeable, with concealed screw fittings; comprising covered, one-piece molded polyurethane foam. Optional, exchangeable back cushion with same features as the seat cushion. Model 183/3 with leather covering is not stackable. Model 183/5 (not stackable) with leather-covered seat and back cushions with wool-fleece overlay and side facings, optionally with seat and back shell covered with leather on the back sections.

#### Armrests

#### Swivel chairs

3-D armrests in reinforced fiberglass polyamide, through-dyed in black or white, with black polyurethane pad, adjustable by 3<sup>7</sup>/<sub>8</sub>" in height and 2" in depth; they can be pivoted inwards and outwards by 15°.

### Cantilever chairs

Armrests comprise round sleeves in a black or white tactile, PVC-free elastomer material. Model 183/5, or optionally with solid wood armrest pads, oak, maple or walnut natural finish. case in die-cast aluminum. Synchro-mechanism cover in black through-dyed polypropylene. Seat bearer in reinforced fiberglass polyamide, through-dyed in black.

#### Standards

Neos swivel chairs conform to the Office Chair Standards DIN EN 1335, ANSI/BIFMA X 5.1 (except for model 181/6) and other international office chair standards. Version conforming to NPR 1813 on request. Depending on selected features, they meet the requirements of categories A or B of the Office Chair Standard DIN EN 1335

180 range swivel chairs comply with the "Ergonomics Approved" requirements.



Some of the 180 range models comply with CAL133 standards. Pricing upon request.

#### Fabric Grades

**Grade 4 = 47** Nova

**Grade 5 = 54** Pitch

**Grade 6 = 60** Blend

**62** Bond

**63** Auris

**66** Lona

**68** Remix 2

**69** Granit

**Grade 9 = 91** Kvadrat

Steelcut Trio 3

#### Skai Faux Leather

**Leather = 74**



180 range cantilever chairs

180 range  
Dimensions



Backrest Height - 20 7/8" to 23 7/32"

Seat Height - 15 3/4" to 20 1/2"

**180 range  
Dimensions**

**Task chair Medium-height backrest**



Seat height **15 3/4" - 20 1/2"**  
 Overall Height **38 5/8" - 43 1/4"**  
 Overall Width **26"**  
 Overall Depth **25 1/4"**

**Counter-height stool, medium-height backrest**

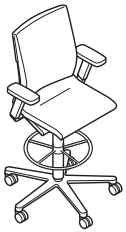

Seat height **26 3/8" - 31 1/2"**  
 Overall Height **49 1/4" - 54 3/8"**  
 Overall Width **26"**  
 Overall Depth **25 1/4"**

**Cantilever chair Standard height backrest**

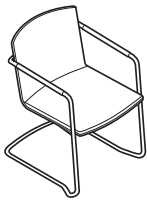

Seat height **16 7/8"**  
 Overall Height **31 1/2"**  
 Overall Width **21 5/8"**  
 Overall Depth **23 5/8"**

**Cantilever chair Standard height backrest, with fully upholstered seat and back**

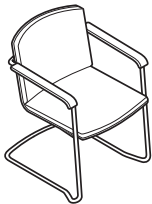

Seat height **16 7/8"**  
 Overall Height **31 1/2"**  
 Overall Width **22 7/8"**  
 Overall Depth **23 5/8"**

**Trolley with 8 stacked cantilever chairs [#183]**

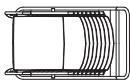

Overall Height **48"**  
 Overall Width **25"**  
 Overall Depth **43"**

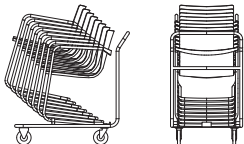

**Dolly with 8 stacked cantilever chairs [#186]**

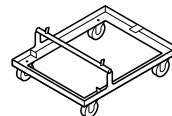

Overall Height **56"**  
 Overall Width **23"**  
 Overall Depth **38"**

**180 range  
Task chairs**

Upholstery material

**Features**

- 3-D armrests
- Pneumatic height adjustment
- Automatic synchro-adjustment, tension control
- Adjustable seat depth
- Adjustable backrest height (181/71 model)

COM	COL	Fabric grade 4	Fabric grade 5	Fabric grade 6 / Skai faux leather	Fabric Grade 9	Leather 74
USD	USD	USD	USD	USD	USD	USD

**181/71 Medium-height backrest**



- base Plastic / shell Plastic <sup>1</sup>**  
seat Upholstered, back Upholstered
- base Matte Polished Aluminum / shell Plastic <sup>1</sup>**  
seat Upholstered, back Upholstered
- base Bright Chrome Aluminum / shell Plastic <sup>1</sup>**  
seat Upholstered, back Upholstered

1316	2219	1295	1337	1443	1603	2169
1478	2381	1457	1499	1605	1765	2331
1652	2555	1631	1673	1779	1939	2505

<sup>1</sup> Shell colors: Black or White

**181/6 Medium-height backrest**



- base Plastic / shell Plastic <sup>1</sup>**  
seat Upholstered, back Mesh <sup>2</sup>
- base Matte Polished Aluminum / shell Plastic <sup>1</sup>**  
seat Upholstered, back Mesh <sup>2</sup>
- base Bright Chrome Aluminum / shell Plastic <sup>1</sup>**  
seat Upholstered, back Mesh <sup>2</sup>

1316	1834	1295	1337	1443	1603	1784
1478	1996	1457	1499	1605	1765	1946
1652	2170	1631	1673	1779	1939	2120

<sup>1</sup> Shell color: Black

<sup>2</sup> Mesh colors: Black or Light Gray or White

**Additional charges/reduced prices specific to range**

**USD**

<b>Shell:</b>	1. a) seat/back shell and 3-D armrests through-dyed in White (181/71 model only)	254
	2. a) height-adjustable lumbar support (181/6 model only)	89
	3. a) polyester Mesh backrest in Light Gray or White (181/6 model only)	19
<b>Armrests:</b>	1. a) without armrests	-141
<b>Other:</b>	1. a) anti-static castors	95

**COM/COL Requirements (181/71 & 181/6)**

**COM (yd)**

**COL (sq.ft.)**

Seat only	1	9
Seat and back	1	20

COM yardage and COL square footage requirements may differ from standard requirements due to leather types and/or fabric patterns. The ultimate yardage/square footage will be determined at time of testing. Please refer to Terms and Conditions for COM/COL terms.

**180 range  
Counter-height stool**

Upholstery material

**Features**

- 3-D armrests
- Pneumatic height adjustment
- Automatic synchro-adjustment, tension control
- Adjustable seat depth
- Adjustable backrest height (181/11 model)
- Footrest in Bright Chrome

COM USD	COL USD	Fabric grade 4 USD	Fabric grade 5 USD	Fabric grade 6 / Skai faux leather USD	Leather 74 USD	Leather 74 USD
------------	------------	-----------------------	-----------------------	--	-------------------	-------------------

**181/11 Counter-height stool, medium-height backrest, upholstered backrest**

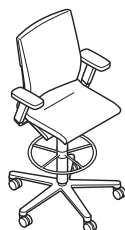

**base Matte Polished Aluminum / shell Plastic <sup>1</sup>**

seat Upholstered, back Upholstered

1953	2856	1932	1974	2080	2099	2806
------	------	------	------	------	------	------

**base Bright Chrome Aluminum / shell Plastic <sup>1</sup>**

seat Upholstered, back Upholstered

2127	3030	2106	2148	2254	2414	2980
------	------	------	------	------	------	------

<sup>1</sup> Shell colors: Black or White

**181/1 Counter-height stool, medium-height backrest, mesh backrest**

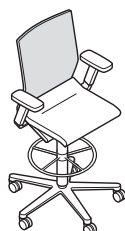

**base Matte Polished Aluminum / shell Plastic <sup>1</sup>**

seat Upholstered, back Mesh <sup>2</sup>

1953	2856	1932	1974	2080	2240	2806
------	------	------	------	------	------	------

**base Bright Chrome Aluminum / shell Plastic <sup>1</sup>**

seat Upholstered, back Mesh <sup>2</sup>

2127	3030	2106	2148	2254	2414	2980
------	------	------	------	------	------	------

<sup>1</sup> Shell color: Black

<sup>2</sup> Mesh colors: Black or Light Gray or White

**Additional charges/reduced prices specific to range**

**USD**

<b>Shell:</b>	1. a) seat/back shell and 3-D armrests through-dyed in White (181/71 model only)	254
	2. a) height-adjustable lumbar support (181/6 model only)	89
	3. a) polyester Mesh backrest in Light Gray or White (181/6 model only)	19
<b>Armrests:</b>	1. a) without armrests	-141

**COM/COL Requirements (181/11 & 181/1)**

**COM (yd)**

**COL (sq.ft.)**

Seat only	1	9
Seat and back	1	20

COM yardage and COL square footage requirements may differ from standard requirements due to leather types and/or fabric patterns. The ultimate yardage/square footage will be determined at time of testing. Please refer to Terms and Conditions for COM/COL terms.

All swivel chairs are fitted with hard castors for soft floors (e.g. carpet). For hard floors (e.g. stone, wood), please specify soft castors when ordering (no additional charge).  
Additional charge for anti-static castors (in combination with aluminum frame).

**180 range  
Cantilever chairs**

Upholstery material

**Features**

Stackable 5-high free-standing (183/3 model)  
Stackable 8-high in trolley (183/3 model)

COM	COL*	Fabric grade 4	Fabric grade 5	Fabric grade 6 / Skai faux leather	Fabric grade 9	Leather 74*
USD	USD	USD	USD	USD	USD	USD

**183/3 Standard height backrest**

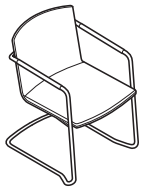

**frame Bright Chrome Aluminum / shell Plastic <sup>1</sup>**

seat Upholstered, back Plastic  
seat Upholstered, back Upholstered

1037	1498	1026	1047	1097	1168	1448
1201	1863	1187	1215	1272	1355	1813

<sup>1</sup> Shell colors: Black or White  
(for White, please see additional charge below)

**183/5 Standard height backrest w/ side stitch (Non-Stackable)**

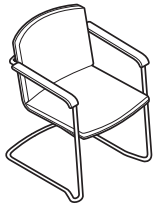

**frame Bright Chrome Aluminum / shell Plastic <sup>1</sup>**

seat Leather, back Leather, armrest Leather

-	2946	-	-	-	-	2896
---	------	---	---	---	---	------

<sup>1</sup> Shell color: Black

**Additional charges/reduced prices specific to range**

		USD
<b>Shell:</b>	1. a) seat/back shell and armrest sleeve in White (183/3 model only)	73
	2. a) seat/back shell covered with Leather on the back sections (183/5 model only)	500
	3. a) solid-wood armrests (183/5 model only)	-384
<b>Other:</b>	1. a) CAL133 compliant charge (applies only to certain models and finishes. Please ensure textiles meet all appropriate flammability requirements)	157

**Accessories**

		USD
183	Four-wheeled trolley for eight stackable cantilever chairs (leather upholstered chairs cannot be stacked on trolley)	1010
186	Four-wheeled dolly for eight stackable cantilever chairs (leather upholstered chairs cannot be stacked on trolley)	687
795/99	Stacking cushion for leather upholstered chairs (seat only)	52
795/99	Double tacking cushion for leather upholstered chairs	104

**COM/COL Requirements (183/3 & 183/5)**

	COM (yd)	COL (sq.ft.)
Seat only (183/3 model)	1	4.5
Seat and back (183/3 model)	1	15
Seat and back (183/5 model)	1	19
Seat and back with upholstered outer back (183/5 model)	N/A	31

COM yardage and COL square footage requirements may differ from standard requirements due to leather types and/or fabric patterns. The ultimate yardage/square footage will be determined at time of testing. Please refer to Terms and Conditions for COM/COL terms.

\* Chairs upholstered in leather require stacking cushions.



180 range task and cantilever chairs

## 184 range

### IN® with Trimension®

Design: wiege



#### Technical Details

##### Function

An office task chair with Trimension®, integrated synchronously supporting 3D kinematics which allows the right-hand and left-hand half of the chair to be tilted in any direction via two swing arms that can move separately from one another. The goal is to encourage the natural range of motion the pelvis is capable of which includes flexing, extending and tilting it sideways to rotating it. The combination of the 3D synchronous adjustment mechanism with a highly elastic seat and back guarantees the chair adapts automatically to any movement made or posture adopted by the person sitting on it. As a result, the body is supported in any position and maintains its center of gravity.

The counter pressure, which provides support in any direction moved in, is infinitely adjustable for people weighing from 99 to 308 lb. by regulating the central spring. The backrest has optional,

height-adjustable lumbar support (in six lockable positions of up to 2.3"). The backrest and seat can be locked in the neutral sitting position, the 3D frontwards tilt of 5° can be activated by pressing a button in order to harness the maximum range of motion. The seat height is infinitely adjustable at the touch of a button between 15 3/4" and 20 1/2" with a DIN 4550 compliant gas lift. Seat depth: 17", optionally with seat depth that can be adjusted while sitting down in 4 lockable positions of 15 3/4" to 17 3/4".

##### Frame

###### Task chairs

Five-star base made of black through-dyed, reinforced fiberglass polyamide, optionally die-cast aluminum, powder coated, polished or high-luster polished. Optionally powder coated in black or silver satin finish, with top cover made of black or through-dyed polypropylene. Gas lift covered by telescopic protective tube made of black through-dyed polypropylene.

Twin-wheel swivel castors with load-dependent braking, made of black polypropylene compliant with DIN EN 12429 as the standard version for carpets, optionally with gray polyurethane facing for hard floors. Antistatic castors on request. Gas lift covered by telescopic protective tube made of black through-dyed polypropylene. Mechanism cover made of die-cast aluminum, coated matte black with black through-dyed polypropylene bellows and thermoplastic elastomer to accommodate the flexibly mounted central spring, knob to adjust the counter pressure made of polyamide (for people weighing from 99 to 308 lb.). Each chair has two swivel arms which can move independently of one another, made of die-cast aluminum, powder coated, polished or high-luster polished, with protective caps made of polypropylene.

###### Counter chair

Star base from the ON 170 range, with additional height-adjustable foot ring, bright chrome-plated, with lock screw to affix it and twin wheel swivel castors with load-dependent braking.

##### Seat and back

Unitary, highly elastic and flexibly suspended seat and back made of high-tech polyamide. Seat shell made of black or white through-dyed polyamide with polypropylene seat upholstery panel. Polyurethane seat cushions with CFC-free foam, covered in Racer, optionally also with form-fit knit (Formstrick) that offers different support zones, in the same material as the backrest cover, or with fabric covers from the Wilkhahn fabric collection, then with facings sewn-in and deep top stitching lengthways to create contours. The seat upholstery panel, cushioning and covers are replaceable. All models except with Formstrick upholstery are available with seat-depth adjustment of 15 3/4" to 17 3/4". Seat cushions covered with form-fit knit (Formstrick) which has different support zones, in the same material as the cover on the backrest, or with fabric covers and then with facing made of black Racer sewn in, only in the same material and color when the seat cover is also in Racer and

color when the seat cover is also in Racer and with deep, lengthways top stitching to create contours.

The seat upholstery panel, cushioning and covers are replaceable. The back section is the frame, optionally with Hytrell® lumbar support, the height of which can be adjusted by 2.36" in six lockable positions and which is retrofittable at any time. The back is covered in form-fit knit (Formstrick) which includes different elasticity for flexible and supporting zones, optional two-ply cover made of form-fit knit (Formstrick) with integrated foam with different support zones. Colors based on the Wilkhahn sample card.



Racer grade 3 fabric (single-ply)



Formstrick grade 4 fabric (double-ply)

### Armrests

Armrests made of fiberglass reinforced, black through-dyed polyamide. 1D armrests height is adjustable in 10 lockable positions by 4". In the case of 3D armrests the armrest pads can also be swivelled 2" inwards and outwards by 25 degrees. In the case of 4D armrests, each can also be adjusted in width by 1". Armrest pads made of black through-dyed polypropylene or optionally of polyurethane foam. Also available without armrests.



1D armrests (up, down)



3D armrests (up, down, sideways)



4D armrests (up, down, sideways, in & out)

### Standards

The IN task chairs comply with the following standards: Office chair standard DIN EN 1335, American standard ANSI/BIFMA X 5.1. and for "Ergonomics tested" certification.

### Please note

If it's very damp, the elasticity of the Formstrick can slightly loosen, but will regain its original shape when it dries.



Plastic base



Powder Coated base

### Fabric Grades

- Grade 3 = 37** Racer
- Grade 4 = 41** Formstrick
- Grade 5 = 54** Pitch
- Grade 6 = 60** Blend
- 63** Auris
- 66** Lona
- 68** Remix 2
- 69** Granit
- Grade 9 = 91** Kvadrat
- Steelcut Trio 3



Matte Polished base



High-Luster Polished base

**IN<sup>®</sup> with Trimension<sup>®</sup>**  
**Dimensions**

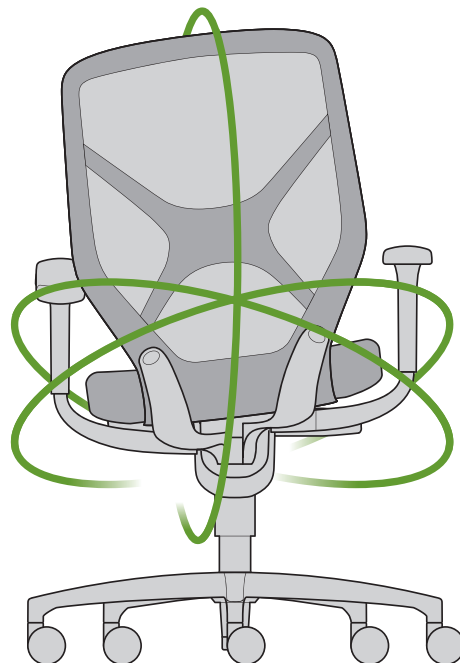
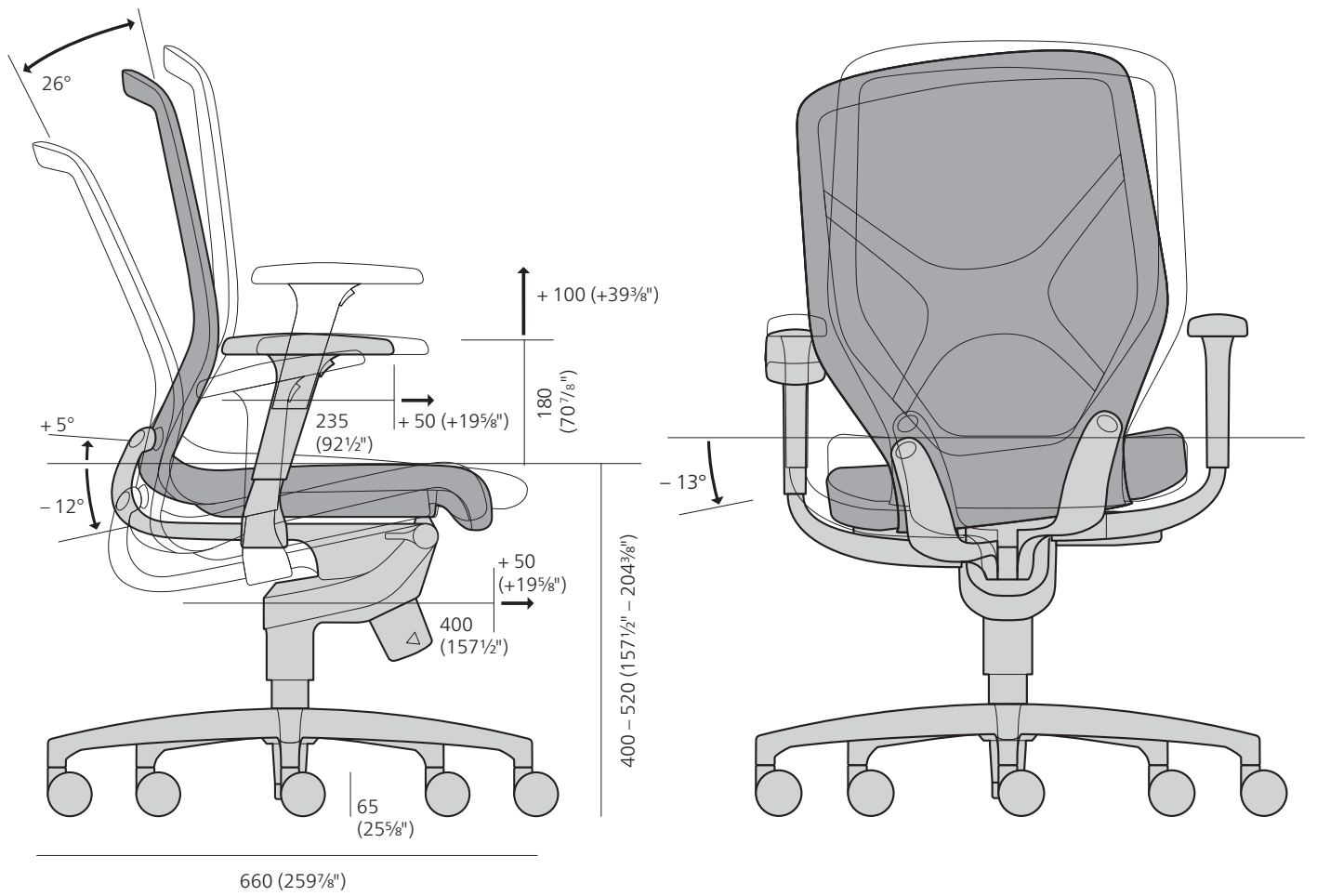

**IN® with Trimension®  
Dimensions**

---

**Task chair Medium-height backrest**



Seat height	<b>15 3/4"-20 1/2"</b>
Overall Height	<b>39 3/4"-44 1/2"</b>
Overall Width	<b>27 1/8"</b>
Overall Depth	<b>26"</b>

**Counter-height stool, medium-height backrest**

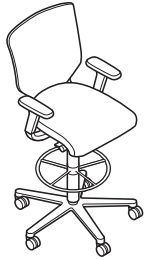

Seat height	<b>25 5/8"-30 3/4"</b>
Overall Height	<b>49 5/8"-54 3/4"</b>
Overall Width	<b>27 1/8"</b>
Overall Depth	<b>26"</b>

**IN® with Trimension®**  
**Task chairs**

**Features**

Trimension tension control  
 Pneumatic height adjustment

Upholstery material					
COM	Racer grade 3	Formstrick grade 4	Fabric grade 5	Fabric grade 6 *	Fabric grade 9
USD	USD	USD	USD	USD	USD

**184/7 Medium-height backrest - Fixed seat with 1D arms**



**base Plastic / swing arms Powder Coated <sup>1</sup>**

seat Fabric, back Formstrick

1507 1415 1443 1571 1640 1742

**base Powder Coated <sup>1</sup> / swing arms Powder Coated <sup>1</sup>**

seat Fabric, back Formstrick

1609 1517 1545 1673 1742 1844

**base Matte Polished Aluminum / swing arms Matte polished aluminum**

seat Fabric, back Formstrick

1737 1645 1673 1801 1870 1972

**base High-Luster Polished Aluminum / swing arms High-Luster Polished Aluminum**

seat Fabric, back Formstrick

1737 1645 1673 1801 1870 1972

**Additional charges to the chair model**

Seat depth adjustment

220 197 220 220 225 232

\* Not available in Skai faux leather

<sup>1</sup> Powder Coat colors: Silver-Satin, Matte Black, Matte Turquoise, Matte Gray, Matte Orange, or Matte Red

\* Adjustable seat depth not available in combination with Formstrick fabric

**Additional charges specific to range**

		USD
<b>Backrest:</b>	1. a) back covered in Formstrick fabric, two-ply, with integrated upholstery foam with different support zones	102
	b) height-adjustable lumbar support	33
<b>Armrests:</b>	1. a) 3D armrests in Black Polypropylene (up charge from 1D armrests)	47
	b) armrest pads made of soft Polyurethane Foam (for 1D & 3D armrests)	24
	c) 4D armrests	95
	d) without armrests	-142
	e) antistatic castors	95

**COM/COL Requirements (184/7)**

	COM (yd)	COL (sq.ft.)
Seat only	1	N/A

COM yardage and COL square footage requirements may differ from standard requirements due to leather types and/or fabric patterns. The ultimate yardage/square footage will be determined at time of testing. Please refer to Terms and Conditions for COM/COL terms.

**IN® with Trimension®  
Counter-height chair**

**Features**

Trimension tension control  
Pneumatic height adjustment  
Footrest in Bright Chrome

Upholstery material					
COM	Racer grade 3	Formstrick grade 4	Fabric grade 5	Fabric grade 6 *	Fabric grade 9
USD	USD	USD	USD	USD	USD

**184/1 Counter-height stool, medium-height backrest - Fixed seat with 1D arms**

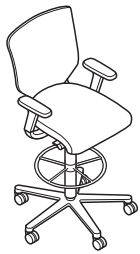

**base Powder Coated <sup>1</sup> / swing arms Powder Coated <sup>1</sup>**

seat Fabric, back Formstrick

2064	1972	2000	2128	2197	2299
------	------	------	------	------	------

**base Matte Polished Aluminum / swing arms Matte polished aluminum**

seat Fabric, back Formstrick

2192	2100	2128	2256	2325	2427
------	------	------	------	------	------

**Additional charges to the chair model**

Seat depth adjustment

220	197	220	220	225	232
-----	-----	-----	-----	-----	-----

\* Not available in Skai faux leather

<sup>1</sup> Powder Coat colors: Silver-Satin, Matte Black, Matte Turquoise, Matte Gray, Matte Orange, or Matte Red

\* Adjustable seat depth not available in combination with Formstrick fabric

**Additional charges specific to range**

		USD
<b>Backrest:</b>	1. a) back covered in Formstrick fabric, two-ply, with integrated upholstery foam with different support zones	102
	b) height-adjustable lumbar support	33
<b>Armrests:</b>	1. a) 3D armrests in Black Polypropylene (up charge from 1D armrests)	47
	b) armrest pads made of soft Polyurethane Foam (for 1D & 3D armrests)	24
	c) 4Darmrests	95
	d) without armrests	-142

**COM/COL Requirements (184/1)**

	COM (yd)	COL (sq.ft.)
Seat only	1	N/A

COM yardage and COL square footage requirements may differ from standard requirements due to leather types and/or fabric patterns. The ultimate yardage/square footage will be determined at time of testing. Please refer to Terms and Conditions for COM/COL terms.

## 186 range

### Metrik

Design: whitelD



#### Technical Details

##### Function

The Metrik cantilever chair stands out for its integrated design approach. The integration of all the components plays with contrasts such as distinctiveness and neutrality, comfort and an understated appeal, as well as modernity and timeless design. As a result, Metrik can be combined with various table concepts and office chairs. A choice of six colors for the body and frame and a plethora of different cover options ensure huge design scalability. To suit preferences, Metrik either complements the overall design concept or purposely adds a splash of color.

##### Chairs

###### Frame

Frame made of tubular steel, with finish options ranging from textured matte (white, black, gray, gray beige, orange red, blue gray) to powder-coating, black chrome and bright chrome plating. Anti-Tilt stopper is made of black polyamide, the standard version for carpets. Multi-purpose glides (partly Teflon) available option for wood floorings. Please order with extra felt glides.

**Please note:** powder coated frame versions are not stackable.

##### Seat and back

Unitary seat and backrest shell with integrated armrests. Armrests and shell made of dyed, reinforced fiberglass-polyamide. Textured matte finish powder coated option available in white, black, gray, gray beige, orange red, or blue gray.

Exchangeable seat cushion consists of seat upholstery panel and covered polyurethane one-piece molded foam. Optional exchangeable back cushioning available.

Weight 19 lb.

##### Accessories

Inline connectors (2 in each set) made of black plastic.

##### Fabric Grades

**Grade 3 = 37** Racer  
**Grade 4 = 41** Formstrick  
47 Nova  
**Grade 5 = 54** Pitch  
**Grade 6 = 60** Blend  
63 Auris  
66 Lona  
68 Remix 2  
**Grade 9 = 91** Kvadrat  
Steelcut Trio 3

**Leather = 74**

**Cantilever chair**



Seat height	<b>17 <sup>3</sup>/<sub>4</sub>"</b>
Overall Height	<b>34 <sup>1</sup>/<sub>4</sub>"</b>
Overall Width	<b>22 <sup>1</sup>/<sub>2</sub>"</b>
Overall Depth	<b>23 <sup>5</sup>/<sub>8</sub>"</b>

**Metrik**  
Cantilever chairs

Upholstery material

**Features**

Seat Cushion as standard on all models

COM	COL*	Fabric grade 3	Fabric grade 4	Fabric grade 5	Fabric grade 6	Fabric grade 9	Leather 74
USD	USD	USD	USD	USD	USD	USD	USD

**186/3 Standard-height backrest**



**frame Powder Coated <sup>1</sup> (non-stackable)**

seat Fabric, back Plastic

781	1082	687	769	793	824	873	1032
-----	------	-----	-----	-----	-----	-----	------

**frame Powder Coated <sup>1</sup> (non-stackable)**

seat Fabric, back Fabric

991	1424	868	974	1007	1048	1112	1374
-----	------	-----	-----	------	------	------	------

**frame Bright Chrome (stackable up to 6 free-standing)**

seat Fabric, back Plastic

853	1154	759	841	865	896	945	1104
-----	------	-----	-----	-----	-----	-----	------

**frame Bright Chrome (stackable up to 6 free-standing)**

seat Fabric, back Fabric

1063	1496	940	1046	1079	1120	1184	1446
------	------	-----	------	------	------	------	------

**frame Black Chrome (stackable up to 6 free-standing)**

seat Fabric, back Plastic

928	1229	834	916	940	971	1020	1179
-----	------	-----	-----	-----	-----	------	------

**frame Black Chrome (stackable up to 6 free-standing)**

seat Fabric, back Fabric

1138	1571	1015	1121	1154	1195	1259	1521
------	------	------	------	------	------	------	------

<sup>1</sup> Powder Coat colors: White, Black, Gray, Gray Beige, Orange Red, Blue Gray

**Accessories**

**USD**

186 Transport trolley for 8 cantilever chairs

687

187 in-line connector set, 2 for bright chrome frame

19

**COM/COL Requirements (186/3)**

**COM (yd)**

**COL (sq.ft.)**

Seat only

0.7/chair, or 0.7/two chairs

5.4/chair, or 10.8/two chairs

Seat and back

0.7/chair, or 1.4/two chairs

10.2/chair, or 20.4/two chairs

Please refer to Terms and Conditions for COM/COL terms.



Metrik chairs



Metrik

## 187 range

### AT

Design: Wilkhahn



#### Technical Details

##### Function

Free-2-move office task chair with integrated synchronized supporting 3D kinematics called Trimension®. The auto-centering seat shell suspension is combined with automatic weight adjustment, and the chair optionally comes with the ability to preset the automatic weight adjustment; with ten increments to suit personal preferences. Trimension® activates the natural range of motion the human pelvis is capable of and matches the way the joints function: from flexing, extending, leaning sideways or rotating the pelvis. When moving in synchrony backwards and forwards, the angle of tilt ranges from 12° in the seat and up to 26° in the backrest, optionally with a 3D forward tilt of up to -5° that can be activated when the backrest is raised. The lumbar support remains in the right position. The seat and back can be tilted sideways from the horizontal line by up to 12°. At the same time, the counter-pressure adjusts automatically to any

posture or movement so that the body always maintains its center of gravity.

AT is suitable for people weighing 99-264 lb. The backrest has height-adjustable lumbar support (in eight lockable positions of up to 2<sup>3</sup>/<sub>8</sub>"). The backrest and seat can be locked in a neutral horizontal 0-position, the optional 5° 3D forward tilt can be activated by lifting the seat and back. The seating height can be precisely adjusted at the touch of a button between 15<sup>3</sup>/<sub>4</sub>" and 20<sup>1</sup>/<sub>2</sub>" with a DIN 4550-compliant gas lift, optionally with a contact suppression feature. Seat depth: 16<sup>7</sup>/<sub>8</sub>", optionally integrated, users can turn a knob while sitting to precision-adjust the seat-depth extension from 15<sup>3</sup>/<sub>8</sub>" to 17<sup>1</sup>/<sub>4</sub>". (The height of the elevated seating position (ESP) models is adjustable from 16<sup>1</sup>/<sub>2</sub>" and 23<sup>3</sup>/<sub>8</sub>" and the counter chairs between 25<sup>5</sup>/<sub>8</sub>" and 30<sup>3</sup>/<sub>8</sub>").

##### Frame

###### Task chairs

Five-star base made of black through-dyed, fiberglass-reinforced polyamide, optionally of die-cast aluminum, powder coated, polished or high-luster polished. Twin wheel swivel castors with load-dependent braking, made of black DIN EN 12529-compliant polypropylene as the standard version for carpets, optionally with gray rubber made of polyurethane for hard flooring. Castors optionally electrically conductive.

The gas lift is covered by a telescopic protective tube made of black or white through-dyed polypropylene. Mechanism shell made of black or white through-dyed, fiberglass-reinforced polyamide with cover made of black or white through-dyed polypropylene. Backrest bearer to suspend the unitary seat and backrest shell made of black or white through-dyed, fiberglass-reinforced polyamide with a central steel joint.

##### Counter stool

With extra height-adjustable foot ring, bright chrome-plated, with lock screw to affix it and twin wheel swivel castors with load-dependent braking.

##### Seat and back

Unitary and highly elastic seat and backrest auto-centring shell suspended on the backrest bearer made of black or white through-dyed glass-bead-reinforced polypropylene. Three backrest heights (standard height, advanced height, advanced height with headrest and neck rest), backrest shell optionally covered in fabric or leather, neck rest made of polyurethane foam, covered in black or gray leather. Seat and back cushioning made of polyurethane with CFC-free foam, as replaceable upholstery element with covers from the Wilkhahn fabric and leather collection. With optional seat-depth extension of 15<sup>3</sup>/<sub>8</sub>" to 17<sup>1</sup>/<sub>4</sub>" which is precision-adjustable by turning a knob. Plastic lumbar support integrated between the seat and backrest shell and backrest cushioning,

height-adjustable by 2<sup>3</sup>/<sub>8</sub>" in eight lockable positions.

#### Optional armrests

Armrests made of fiberglass-reinforced, black or white through-dyed polyamide with armrest pads made of gray through-dyed polypropylene, optionally with armrest pads made of gray through-dyed polyurethane foam. 1D armrests height-adjustable by 4" in ten lockable positions, the depth of the armrest pads on 3D armrests can also be extended by 2" and the width by 1", 4D armrests can also rotate inwards and outwards by 25°.

#### Standards (testing ongoing)

DIN EN 1335, ANSI/BIFMA X 5.1., GS and IGR standards. All components used to adjust the chair (slide buttons and levers to adjust and lock the height, components for adjusting the lumbar support and knob for optional seat-depth extension) are made of gray through-dyed plastic.

#### Fabric Grades

- Grade 3 = 37** Racer
- Grade 4 = 47** Nova
- Grade 5 = 54** Pitch
- Grade 6 = 60** Blend
- 62** Bond
- 63** Auris
- 66** Lona
- 68** Remix 2
- 69** Granit
- Grade 9 = 91** Steelcut Trio 3

**Leather = 74**



#### Locking/optional presetting the automatic weight adjustment

The push button on the left locks the chair in a neutral 0 position and the knob allows presetting in ten increments to adapt to personal levels of comfort.



#### Integrated lumbar support and optional forward tilt

All AT models feature integrated lumbar support. The optional activation of the innovative forward seat tilt raises in synchrony the backrest and the lumbar support.



#### Trimension®

Without altering the chair, the auto-centering suspension of the seat shell, the backrest bearer, and the automatic weight adjustment allow bodies to maintain their center of gravity – whatever the posture or movement is.



AT chairs and Travis height-adjustable tables



AT chair, Occo table and Occo chairs

**Task chair Medium-height backrest**



Seat height **15 <sup>3</sup>/<sub>4</sub>"-20 <sup>1</sup>/<sub>2</sub>"**  
Overall Height **38 <sup>5</sup>/<sub>8</sub>"-43 <sup>1</sup>/<sub>4</sub>"**  
Overall Width **26 <sup>3</sup>/<sub>8</sub>"**  
Overall Depth **25 <sup>1</sup>/<sub>4</sub>"**

**Task chair High backrest**



Seat height **15 <sup>3</sup>/<sub>4</sub>"-20 <sup>1</sup>/<sub>2</sub>"**  
Overall Height **43 <sup>1</sup>/<sub>4</sub>"-48"**  
Overall Width **26 <sup>3</sup>/<sub>8</sub>"**  
Overall Depth **25 <sup>1</sup>/<sub>4</sub>"**

**Task chair High backrest with headrest and neck rest**



Seat height **15 <sup>3</sup>/<sub>4</sub>"-20 <sup>1</sup>/<sub>2</sub>"**  
Overall Height **47 <sup>1</sup>/<sub>4</sub>"-52"**  
Overall Width **26 <sup>3</sup>/<sub>8</sub>"**  
Overall Depth **25 <sup>1</sup>/<sub>4</sub>"**

**Task chair with Elevated seating position**



Seat height **16 <sup>1</sup>/<sub>2</sub>"-24 <sup>3</sup>/<sub>8</sub>"**  
Overall Height **39 <sup>3</sup>/<sub>8</sub>"-46 <sup>1</sup>/<sub>2</sub>"**  
Overall Width **26 <sup>3</sup>/<sub>8</sub>"**  
Overall Depth **25 <sup>1</sup>/<sub>4</sub>"**

**Counter-height stool**

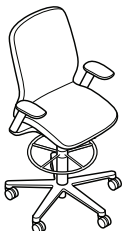

Seat height **25 <sup>5</sup>/<sub>8</sub>"-30 <sup>3</sup>/<sub>8</sub>"**  
Overall Height **48 <sup>1</sup>/<sub>2</sub>"-53 <sup>1</sup>/<sub>8</sub>"**  
Overall Width **26 <sup>3</sup>/<sub>8</sub>"**  
Overall Depth **25 <sup>1</sup>/<sub>4</sub>"**

**AT**  
**Task chairs**

Upholstery material

**Features**

3D kinematics with automatic weight adjustment, optionally with individual-presetting  
Trimension  
Pneumatic height adjustment  
Height-adjustable lumbar support

COM	COL	Fabric grade 3	Fabric grade 4	Fabric grade 5	Fabric grade 6 *	Fabric grade 9	Leather 74
USD	USD	USD	USD	USD	USD	USD	USD

**187/7 Medium-height backrest with 1D armrests**



**base Plastic / shell & mechanism black**

seat Fabric, back plastic

1440 2087 1302 1396 1483 1553 1659 2037

**base Powder Coated / shell & mechanism black**

seat Fabric, back fabric

1558 2205 1420 1514 1601 1671 1777 2155

**based Polished Aluminum / shell & mechanism black**

seat Fabric, , back plastic

1630 2277 1492 1586 1673 1743 1849 2227

**based High-Luster Polished Aluminum / shell & mechanism black**

seat Fabric, back fabric

1654 2301 1516 1610 1697 1767 1873 2251

**base Powder Coated / shell & mechanism white**

seat Fabric, back plastic

1618 2265 1480 1574 1661 1731 1837 2215

**based Polished Aluminum / shell & mechanism white**

seat Fabric, back fabric

1690 2337 1552 1646 1733 1803 1909 2287

**based High-Luster Polished Aluminum / shell & mechanism white**

seat Fabric, back fabric

1714 2361 1576 1670 1757 1827 1933 2311

<sup>1</sup> Powder Coat colors: White or Black

\* Not available in Skai faux leather

**Additional charges to the chair model**

Seat/backrest shell covered in fabric on the rear (fabric 68 not possible) 164 - - 154 174 251 323 -

**Additional charges/reduced prices specific to range**

**USD**

<b>Armrests:</b>	1. a) 3D armrests, made of PP; or	94
	b) 4D armrests, made of PP; or	144
	c) without armrests	-145
	d) armrest pads made of polyurethane foam for 1D, 3D and 4D armrests	34
<b>Other:</b>	1. a) anti-static castors	95
	2. a) 3D forward tilt can be activated by 5°	46
	3. a) seat depth extension for Racer (grade 3)	96
	4. a) seat depth extension for all other fabric grades (excluding grade 3)	121
	5. a) seat depth suspension	58

**COM/COL Requirements (187/7)**

**COM (yd)**

**COL (sq.ft.)**

Seat and fixed back	1	N/A
Seat and fixed back fully upholstered	1.5	N/A
Seat and adjustable back	1	N/A
Seat and adjustable back fully upholstered	1.5	N/A

COM yardage and COL square footage requirements may differ from standard requirements due to leather types and/or fabric patterns. The ultimate yardage/square footage will be determined at time of testing. Please refer to Terms and Conditions for COM/COL terms.

**AT**  
**Task chairs**

Upholstery material

**Features**

3D kinematics with automatic weight adjustment, optionally with individual presetting  
Trimension  
Pneumatic height adjustment  
Height-adjustable lumbar support

COM	COL	Fabric grade 3	Fabric grade 4	Fabric grade 5	Fabric grade 6 *	Fabric grade 9	Leather 74
USD	USD	USD	USD	USD	USD	USD	USD

**187/8 High backrest with 1D armrests**



**base Plastic / shell & mechanism black**

seat Fabric, back plastic

1640 2258 1483 1589 1690 1767 1898 2208

**base Powder Coated / shell & mechanism black**

seat Fabric, back fabric

1758 2376 1601 1707 1808 1885 2016 2326

**based Polished Aluminum / shell & mechanism black**

seat Fabric, , back plastic

1830 2448 1673 1779 1880 1957 2088 2398

**based High-Luster Polished Aluminum / shell & mechanism black**

seat Fabric, back fabric

1854 2472 1697 1803 1904 1981 2112 2422

**base Powder Coated / shell & mechanism white**

seat Fabric, back plastic

1818 2436 1661 1767 1868 1945 2076 2386

**based Polished Aluminum / shell & mechanism white**

seat Fabric, back fabric

1890 2508 1733 1839 1940 2017 2148 2458

**based High-Luster Polished Aluminum / shell & mechanism white**

seat Fabric, back fabric

1914 2532 1757 1863 1964 2041 2172 2482

<sup>1</sup> Powder Coat colors: White or Black

\* Not available in Skai faux leather

**Additional charges to the chair model**

Seat/backrest shell covered in fabric on the rear (fabric 68 not possible) 1164 - - 154 174 251 323 -

**Additional charges/reduced prices specific to range**

**USD**

<b>Armrests:</b>	1. a) 3D armrests, made of PP; or	94
	b) 4D armrests, made of PP; or	144
	c) without armrests	-145
	d) armrest pads made of polyurethane foam for 1D, 3D and 4D armrests	34
<b>Other:</b>	1. a) anti-static castors	95
	2. a) 3D forward tilt can be activated by 5°	46
	3. a) seat depth extension for Racer (grade 3)	96
	4. a) seat depth extension for all other fabric grades (excluding grade 3)	121
	5. a) seat depth suspension	58

**COM/COL Requirements (187/8)**

**COM (yd)**

**COL (sq.ft.)**

Seat and fixed back	1.5	N/A
Seat and fixed back fully upholstered	1.5	N/A
Seat and adjustable back	1.5	N/A
Seat and adjustable back fully upholstered	1.5	N/A

COM yardage and COL square footage requirements may differ from standard requirements due to leather types and/or fabric patterns. The ultimate yardage/square footage will be determined at time of testing. Please refer to Terms and Conditions for COM/COL terms.

All swivel chairs are fitted with hard castors for soft floors (e.g. carpet). For hard floors (e.g. stone, wood), please specify soft castors when ordering (no additional charge).  
Additional charge for anti-static castors (in combination with aluminum frame).

**AT**  
**Task chairs**

Upholstery material

**Features**

3D kinematics with automatic weight adjustment, optionally with individual presetting  
Trimension  
Pneumatic height adjustment  
Height-adjustable lumbar support  
Neck rest covered as desired either in 74/99 or 74/34 leather, or in the same material as the seat and backrest cushioning

COM	COL	Fabric grade 3	Fabric grade 4	Fabric grade 5	Fabric grade 6 *	Fabric grade 9	Leather 74
USD	USD	USD	USD	USD	USD	USD	USD

**187/9 High backrest with headrest and neck rest and 1D armrests**



<b>base Plastic / shell &amp; mechanism black</b> seat Fabric, back plastic	2108	2699	1902	2042	2174	2278	2447	2649
<b>base Powder Coated / shell &amp; mechanism black</b> seat Fabric, back fabric	2226	2817	2020	2160	2292	2396	2565	2767
<b>based Polished Aluminum / shell &amp; mechanism black</b> seat Fabric, , back plastic	2298	2889	2092	2232	2364	2468	2637	2839
<b>based High-Luster Polished Aluminum / shell &amp; mechanism black</b> seat Fabric, back fabric	2322	2913	2116	2256	2388	2492	2661	2863
<b>base Powder Coated / shell &amp; mechanism white</b> seat Fabric, back plastic	2286	2877	2080	2220	2352	2456	2625	2827
<b>based Polished Aluminum / shell &amp; mechanism white</b> seat Fabric, back fabric	2358	2949	2152	2292	2424	2528	2697	2899
<b>based High-Luster Polished Aluminum / shell &amp; mechanism white</b> seat Fabric, back fabric	2382	2973	2176	2316	2448	2552	2721	2923

<sup>1</sup> Powder Coat colors: White or Black

\* Not available in Skai faux leather

**Additional charges to the chair model**

Seat/backrest shell covered in fabric on the rear (fabric 68 not possible)	164	-	-	154	174	251	323	-
--	-----	---	---	-----	-----	-----	-----	---

**Additional charges/reduced prices specific to range**

	USD
<b>Armrests:</b>	
1. a) 3D armrests, made of PP; or	94
b) 4D armrests, made of PP; or	144
c) without armrests	-145
d) armrest pads made of polyurethane foam for 1D, 3D and 4D armrests	34
<b>Other:</b>	
1. a) anti-static castors	95
2. a) 3D forward tilt can be activated by 5°	46
3. a) seat depth extension for Racer (grade 3)	96
4. a) seat depth extension for all other fabric grades (excluding grade 3)	121
5. a) seat depth suspension	58

**COM/COL Requirements (187/9)**

	COM (yd)	COL (sq.ft.)
Seat and fixed back	1.5	N/A
Seat and fixed back fully upholstered	1.5	N/A
Seat and adjustable back	1.5	N/A
Seat and adjustable back fully upholstered	1.5	N/A

COM yardage and COL square footage requirements may differ from standard requirements due to leather types and/or fabric patterns. The ultimate yardage/square footage will be determined at time of testing. Please refer to Terms and Conditions for COM/COL terms.

**AT**  
**Task chairs**

Upholstery material

**Features**

3D kinematics with automatic weight adjustment, optionally with individual presetting  
 Trimension  
 Pneumatic height adjustment  
 Height-adjustable lumbar support  
 Seat height adjustable from 16<sup>1</sup>/<sub>2</sub>" to 23<sup>5</sup>/<sub>8</sub>"  
 3D forward tilt can be activated by 5°

COM	COL	Fabric grade 3	Fabric grade 4	Fabric grade 5	Fabric grade 6 *	Fabric grade 9	Leather 74
USD	USD	USD	USD	USD	USD	USD	USD

**187/72 Elevated seating position with 1D armrests**



**base Plastic / shell & mechanism black**

seat Fabric, back plastic

**base Powder Coated / shell & mechanism black**

seat Fabric, back fabric

**based Polished Aluminum / shell & mechanism black**

seat Fabric, , back plastic

**based High-Luster Polished Aluminum / shell & mechanism black**

seat Fabric, back fabric

**base Powder Coated / shell & mechanism white**

seat Fabric, back plastic

**based Polished Aluminum / shell & mechanism white**

seat Fabric, back fabric

**based High-Luster Polished Aluminum / shell & mechanism white**

seat Fabric, back fabric

1592	2239	1454	1548	1635	1705	1811	2189
1710	2357	1572	1666	1753	1823	1929	2307
1782	2429	1644	1738	1825	1895	2001	2379
1806	2453	1668	1762	1849	1919	2025	2403
1770	2417	1632	1726	1813	1883	1989	2367
1842	2489	1704	1798	1885	1955	2061	2439
1866	2513	1728	1822	1909	1979	2085	2463

<sup>1</sup> Powder Coat colors: White or Black

\* Not available in Skai faux leather

**Additional charges to the chair model**

Seat/backrest shell covered in fabric on the rear (fabric 68 not possible)

164	-	-	154	174	251	323	-
-----	---	---	-----	-----	-----	-----	---

**Additional charges/reduced prices specific to range**

	USD
<b>Armrests:</b>	
1. a) 3D armrests, made of PP; or	94
b) 4D armrests, made of PP; or	144
c) without armrests	-145
d) armrest pads made of polyurethane foam for 1D, 3D and 4D armrests	34
<b>Other:</b>	
1. a) anti-static castors	95
2. a) seat depth extension for Racer (grade 3)	96
3. a) seat depth extension for all other fabric grades (excluding grade 3)	121

**COM/COL Requirements (187/72)**

	COM (yd)	COL (sq.ft.)
Seat and fixed back	1	N/A
Seat and fixed back fully upholstered	1.5	N/A
Seat and adjustable back	1	N/A
Seat and adjustable back fully upholstered	1.5	N/A

COM yardage and COL square footage requirements may differ from standard requirements due to leather types and/or fabric patterns. The ultimate yardage/square footage will be determined at time of testing. Please refer to Terms and Conditions for COM/COL terms.

**AT**  
**Task chairs**

Upholstery material

**Features**

3D kinematics with automatic weight adjustment, optionally with individual presetting  
Trimension  
Pneumatic height adjustment  
Height-adjustable lumbar support  
With foot ring, bright chrome-plated, height-adjustable

COM	COL	Fabric grade 3	Fabric grade 4	Fabric grade 5	Fabric grade 6 *	Fabric grade 9	Leather 74
USD	USD	USD	USD	USD	USD	USD	USD

**187/1 Counter stool with 1D armrests**

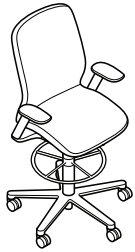

<b>base Powder Coated / shell &amp; mechanism black</b> seat Fabric, back fabric	2009	2685	1871	1965	2052	2122	2228	2635
<b>based Polished Aluminum / shell &amp; mechanism black</b> seat Fabric, , back plastic	2081	2757	1943	2037	2124	2194	2300	2707
<b>based High-Luster Polished Aluminum / shell &amp; mechanism black</b> seat Fabric, back fabric	2105	2781	1967	2061	2148	2218	2324	2731
<b>base Powder Coated / shell &amp; mechanism white</b> seat Fabric, back plastic	2069	2745	1931	2025	2112	2182	2288	2695
<b>based Polished Aluminum / shell &amp; mechanism white</b> seat Fabric, back fabric	2141	2817	2003	2097	2184	2254	2360	2767
<b>based High-Luster Polished Aluminum / shell &amp; mechanism white</b> seat Fabric, back fabric	2165	2841	2027	2121	2208	2278	2384	2791

<sup>1</sup> Powder Coat colors: White or Black

\* Not available in Skai faux leather

**Additional charges to the chair model**

Seat/backrest shell covered in fabric on the rear (fabric 68 not possible)	164	-	-	154	174	251	323	-
--	-----	---	---	-----	-----	-----	-----	---

**Additional charges/reduced prices specific to range**

**USD**

<b>Armrests:</b>	1. a) 3D armrests, made of PP; or	94
	b) 4D armrests, made of PP; or	144
	c) without armrests	-145
	d) armrest pads made of polyurethane foam for 1D, 3D and 4D armrests	34

**COM/COL Requirements (187/1)**

**COM (yd)**

**COL (sq.ft.)**

Seat and fixed back	1	N/A
Seat and fixed back fully upholstered	1.5	N/A
Seat and adjustable back	1	N/A
Seat and adjustable back fully upholstered	1.5	N/A

COM yardage and COL square footage requirements may differ from standard requirements due to leather types and/or fabric patterns. The ultimate yardage/square footage will be determined at time of testing. Please refer to Terms and Conditions for COM/COL terms.



AT chair and Travis height-adjustable table

## 20 range

### Stitz 2

Design: ProduktEntwicklung Roericht



#### Technical Details

##### Function

The Stitz is a leaning aid with infinitely variable height adjustment by means of an encapsulated gas lift.

##### Frame

Black elastomer base filled with quartz sand. Black polyamide base plate.

##### Seat

Black polyamide seat frame. Cork inset, optionally hard wax treated, covered in fabric or in embossed leather. Gas lift lever for height adjustment, accessible all round, underneath black polyamide seat base.

#### Stitz Dimensions

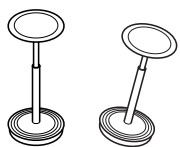

Overall Height **23 5/8"-32 5/8"**  
Overall Width **12 1/4"**



Stitz 2

**Stitz 2**  
Leaning aid

Upholstery material

**Features**

Free standing leaning aid with weighted bottom  
Height adjustable 23<sup>5</sup>/<sub>8</sub>" to 32<sup>5</sup>/<sub>8</sub>"

	Cork	Fabric grade 6	Leather 74
	USD	USD	USD

**201/1, 201/2 Stitz**

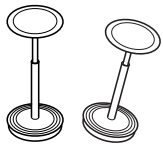

**frame Aluminum**  
seat Cork, Fabric, or Perforated Leather

<b>201/01</b>	<b>201/02</b>	<b>201/02</b>
1128	1258	1313

**90 201/1, 90 201/2 Stitz - Quick ship program** (up to 15 Stitz delivered in 1 week)

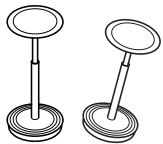

**frame Aluminum**  
seat Cork, Fabric, or Perforated Leather

<b>90 201/01</b>	<b>90 201/02</b> <i>black Leather only</i>
1128	1313



Stitz 2



Stitz 2

## 204 range

### Sitzbock®

Design: Rudolph S. Webermann



#### Technical Details

##### Function

A pommel horse seat weighing just 10.6 lbs that's ideal for informal interaction in kitchenettes, bistros and workshops and enables a range of different postures: users can lean on it, sit side saddle or position themselves astride it.

##### Frame

###### Body/ Frame

Four-leg seat made of through-dyed polyethylene in black, white, gray or orange-red with non-slip multipurpose glides. Also suitable for temporary use in outdoor rooms. Up to four pommel horse seats can be stacked across one another.

Optional felt blanket in anthracite, a light mottled hue, graphite or mango with a rubber underside which is attached with ten expanding rivets.

##### Please note:

The models are suitable for outdoor use. Nevertheless, we recommend to not over-expose this furniture to the effects of sun, rain, dust and wind and to keep it in a dry and well-aired place when not using. When exposed to ultra violet rays for long periods of time, the colors of the plastics may change slightly.

Felt is a natural product. Therefore, there can be differences in the color from piece to piece. Like all natural materials they have inherent disparities in color. This feature underscore the material's uniqueness. Because of variations caused by nature, over which the company has no control, Wilkhahn cannot warrant color matching.

##### Differences in color/ structure

**Frame** The combination of different materials, such as chrome plating, or varnishing aluminium, steel or plastic can lead to differences in the color and structure when the surfaces are compared. These differences do not constitute grounds for complaint and is not covered under warrant.

As regards to our upholstery materials and laminates, despite selecting them carefully, there can be slight differences in color which are due to the batch they are produced in. This is a result of our pre-suppliers' manufacturing processes and is therefore not under warranty.

**Sitzbock**  
Casual seating

**Features**

Four-leg pommel seat made of through-dyed polyethylene  
Up to four pommel horse seats can be stacked across one another.  
Optional felt blanket with rubber underside

USD

**Sitzbock**



**204 Sitzbock**  
**25"W x 20"D x 30"H**

**Polyethylene Finishes**

204/01 Black Finish	699
204/02 White Finish	699
204/03 Gray Finish	699
204/04 Orange-Red Finish	699

**Felt Seat Pad**

Color options:	
204/11 Graphite	142
204/12 Light Mottled hue	142
204/13 Anthracite	142
204/14 Mango	142

\* All foam used is CFC-free.  
\* felt pad has rubber underside which is attached with ten expanding rivets.

# 208 range Landing®

Design: Rudolph S. Webermann

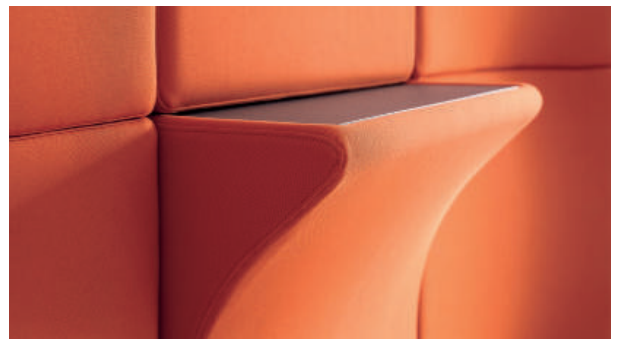

## Technical Details

### Function

Decorative and sound-absorbent wall relief that can be combined as desired to lean, sit or place things on in aisles, cross-over spaces and staircases in order to encourage users to meet and talk to other people. Landing improves acoustics, creates niches, takes the weight off feet while standing and is a space for drinks and smartphones.

### Frame

**Model 208/1**  
Model 208/1 flat element  
Core panels made of laminated wood, upholstered with PUR foam and covered in fabric.

**Model 208/2**  
Core panels made of laminated wood and MDF, upholstered with PUR foam and covered in fabric. May be fitted vertically to lean-on or horizontally to perch on, or rotated by 180° to make a table/shelf.

### Please note:

**Model 208/2**  
Comes with optional sheet steel surface screwed on from the inside, coated with a textured matte finish in gray.

With two integrated attachments for each edge length that enable users to hang it up and engage it at any right angles and four fittings to mount it to the wall.

### Fabric options

Fabric Grades  
**Grade 37** Racer  
**Grade 5 = 54** Pitch  
**Grade 6 = 60** Blend  
**62** Bond  
**63** Auris  
**66** Lona



**Landing  
Casual seating**

Upholstery material

37 Racer  
54 Pitch  
Fabric grade 6\*

**USD USD USD**

**Landing**

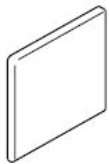

**208/01**  
**23 1/2" W x 23 1/2" H x 2"D**  
Flat Element

\*Not available in fabric grade 68 & 69

422 470 567

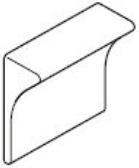

**208/02**  
**23 1/2" W x 23 1/2" H x 9"D**  
Relief Element  
Optionally available with table rest (see pricing below)

\*Not available in fabric grade 68 & 69

617 701 817

**Additional charges/reduced prices specific to range**

**USD**

**Other:**

1. a) Table Rest

159

## 21 range

### FS-Line

Design: Klaus Franck, Werner Sauer



#### Technical Details

##### Function

Task chairs with automatic synchro-adjustment: the seat/backrest angle adjusts automatically to the sitting position of the user. When leaning back, the backrest tension increases according to the need for additional support. Infinitely variable tension adjustment for the user. Forward position lockable by engaging lever. Encapsulated gas lift, conforming to DIN 4550, for infinitely variable adjustment of seat height.

Conference chairs/visitor chairs with automatic synchro-adjustment, without front locking position, with fixed seat height.

##### Frame

###### Task chairs

Die-cast aluminum star base, bright chrome-plated, polished or powder coated. Twin wheel swivel castors in black polyamide with load-dependent braking, conforming to DIN EN 12529, as the standard version for carpeted floors, or with a gray polyurethane soft lining for hard floors. Anti-static castors on request. Glides in black polyamide as the standard version for carpeted floors, or in black polyurethane for hard floors.

Swing arms in die-cast aluminum, bright chrome-plated or color-coated, depending on star base (powder coated black for polished star-base).

###### 211/1 counter chair

With FS-star base on glides.

###### 211/11 counter stool

Star base from the ON 170 range, with additional height-adjustable foot ring, bright chrome-plated, with lock screw to affix it with and twin wheel swivel castors with load-dependent braking.

##### Cantilever chairs

Frame of models 212/5 in round steel tube, bright chrome-plated or powder coated; stackable version with bright chrome-plated frame only.

Cantilever models 212 with anti-tilt stoppers as the standard version for carpeted floors, with additional glides for hard floors, on request with felt insert.

##### Seat and back

###### Models 211/1 to 213/8

Seat and backrest shell in viscoelastic, through-dyed polypropylene with a flexible middle section in the colors

91 natural white

92 platinum

97 asphalt

99 black.

Standard armrests in the same material, black.

Backrest of task chairs 211 and 213 optionally with integral, adjustable lumbar support.

Seat upholstery: one-piece moulded foam covered, exchangeable.

##### Seat and back

###### Models 220/8 to 220/9

Tubular steel frame with flexible middle section, over which is stretched an elastic mesh and the whole is molded in foam. Armrests in integral foam, leather-covered, in black for fabric cover and in matching color leather for leather cover. Cover with stitched fluting, exchangeable, or cover with integral slim cushion, exchangeable.

## Standards

FS swivel chairs conform to the Office Chair Standard DIN EN 1335, ANSI/BIFMA X 5.1, BS 5459 and other international office chair standards.

Depending on selected features, they meet the requirements of categories B or C of the Office Chair Standard DIN EN 1335. FS cantilever chairs conform to DIN 68878 – 1 and BS 5459.



FS swivel chairs conform to the standard "Ergonomics Approved" label.



## Fabric Grades

- Grade 5 = 54** Pitch
- Grade 6 = 60** Blend
  - 62** Bond [excludes 211 & 213 models]
  - 63** Auris
  - 66** Lona
  - 68** Remix 2 [excludes 211 & 213 models]
  - 69** Granit
- Grade 9 = 91** Steelcut Trio 3 [excludes 211 & 213 models]
  
- Leather = 74**
- Leather = 87**

## GREENGUARD™

Virtually all Wilkhahn products undergo testing and certification in accordance with GREENGUARD. The Greenguard Environmental Institute is an independent institution in the US that certifies products with regard to their suitability for interiors. Besides environmental aspects, special focus is on ensuring that products do not emit any pollutants that might be harmful to health.



**Conference/visitor chair Standard height backrest**

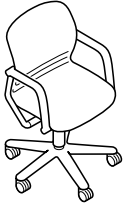

Seat height **16 1/2" - 20 7/8"**  
 Overall Height **34 5/8" - 39"**  
 Overall Width **24 3/4"**  
 Overall Depth **23 5/8"**

**Cantilever chair Standard height backrest**



Seat height **17 3/8"**  
 Overall Height **33 1/2"**  
 Overall Width **22"**  
 Overall Depth **24"**

**Conference/visitor chair High backrest**



Seat height **16 1/2" - 20 7/8"**  
 Overall Height **41 3/8" - 45 5/8"**  
 Overall Width **25 5/8"**  
 Overall Depth **24 3/8"**

**Management Medium-height backrest**



Seat height **16 1/2" - 20 1/2"**  
 Overall Height **39 3/8" - 43 1/4"**  
 Overall Width **26 3/8"**  
 Overall Depth **24 3/4"**

**Counter chair**

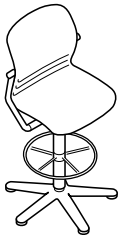

Seat height **20 1/2" - 24 3/4"**  
 Overall Height **42 7/8" - 47 1/4"**  
 Overall Width **25 5/8"**  
 Overall Depth **24 3/4"**

**Management High backrest**



Seat height **16 1/2" - 20 1/2"**  
 Overall Height **45 5/8" - 49 5/8"**  
 Overall Width **26 3/8"**  
 Overall Depth **24 3/4"**

**Task chair Medium-height backrest**



Seat height **16 1/2" - 20 1/2"**  
 Overall Height **36 5/8" - 40 1/2"**  
 Overall Width **26"**  
 Overall Depth **25 5/8"**

**Task chair High backrest**

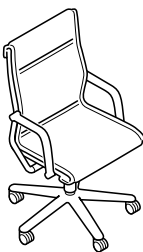

Seat height **16 1/2" - 20 1/2"**  
 Overall Height **40 1/2" - 44 1/2"**  
 Overall Width **26"**  
 Overall Depth **25 5/8"**



FS-Line chairs

**FS-Line**  
**Conference/visitor chairs**

Upholstery material

**Features**

One-piece seat and back shell, upholstered  
Pneumatic height adjustment  
Automatic synchro-adjustment, tension control  
With foot ring (211/1 model)

COM	Fabric grade 5	Fabric grade 6 *
USD	USD	USD

**211/8 Standard height backrest**

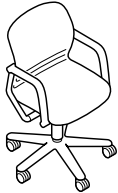

**base Matte Polished Aluminum / swing arms Polished Al. / shell Plastic <sup>1</sup>**

seat Fabric, back Fabric

2138 2085 2191

**base Bright Chrome Aluminum / swing arms Bright Chrome / shell Plastic <sup>1</sup>**

seat Fabric, back Fabric

2167 2114 2220

**213/8 High backrest**



**base Matte Polished Aluminum / swing arms Polished Al. / shell Plastic <sup>1</sup>**

seat Fabric, back Fabric

2441 2388 2494

**base Bright Chrome Aluminum / swing arms Bright Chrome / shell Plastic <sup>1</sup>**

seat Fabric, back Fabric

2470 2417 2523

**211/1 Counter chair**



**base Matte Polished Aluminum / swing arms Polished Al. / shell Plastic <sup>1</sup>**

seat Fabric, back Fabric

2779 2726 2832

**base Bright Chrome Aluminum / swing arms Bright Chrome / shell Plastic <sup>1</sup>**

seat Fabric, back Fabric

2808 2755 2861

**211/11 Counter chair**

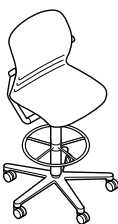

**base Matte Polished Aluminum / swing arms Polished Al. / shell Plastic <sup>1</sup>**

seat Fabric, back Fabric

2511 2458 2564

**base Bright Chrome Aluminum / swing arms Bright Chrome / shell Plastic <sup>1</sup>**

seat Fabric, back Fabric

2622 2569 2675

<sup>1</sup> Shell colors: Black or White

\* Not available in Skai faux leather

**Additional charges/reduced prices specific to range**

**USD**

<b>Frame:</b>	1. a) base and swing arms Powder Coated <sup>1</sup>	-106
<b>Shell:</b>	1. a) height-adjustable lumbar support	137
<b>Armrests:</b>	1. a) without armrests	-169
<b>Other:</b>	1. a) anti-static castors	95

**COM/COL Requirements (211/8, 213/8 & 211/1)**

**COM (yd)**

**COL (sq.ft.)**

Seat and back 1.5 \*

\* COL pricing and requirements on request

COM yardage and COL square footage requirements may differ from standard requirements due to leather types and/or fabric patterns. The ultimate yardage/square footage will be determined at time of testing. Please refer to Terms and Conditions for COM/COL terms.

**FS-Line  
Task chairs**

Upholstery material

**Features**

One-piece seat and back shell, fully upholstered  
Stitched fluting  
Pneumatic height adjustment  
Automatic synchro-adjustment, tension control

COM	COL	Fabric grade 6*	Fabric grade 9	Leather 74†	Leather 87†
USD	USD	USD	USD	USD	USD

**220/8 Medium-height backrest**



**base Matte Polished Aluminum / swing arms Polished Aluminum**

seat Upholstered, back Upholstered

5607 7051 5548 5666 7001 (7001)

**base Bright Chrome Aluminum / swing arms Bright Chrome**

seat Upholstered, back Upholstered

5677 7080 5577 5777 7030 (7030)

\*Not available in Fabric 62 - Bond or Skai faux leather

†With leather upholstery, armrests in matching leather

**Additional charges to the chair model**

slim cushion (Leather 87 is only available with slim cushion option)

546 669 441 651 619 1550

**220/9 High backrest**



**base Matte Polished Aluminum / swing arms Polished Aluminum**

seat Upholstered, back Upholstered

6470 8177 6411 6529 8127 (8127)

**base Bright Chrome Aluminum / swing arms Bright Chrome**

seat Upholstered, back Upholstered

6540 8206 6440 6640 8156 (8156)

\*Not available in Fabric 62 - Bond or Skai faux leather

†With leather upholstery, armrests in matching leather

**Additional charges to the chair model**

slim cushion (Leather 87 is only available with slim cushion option)

668 742 545 790 692 1738

**Additional charges/reduced prices specific to range**

**USD**

<b>Frame:</b>	1. a) base and swing arms Powder Coated <sup>1</sup>	-181
<b>Other:</b>	1. a) anti-static castors	90

**COM/COL Requirements (220/8 & 220/9)**

**COM (yd)**

**COL (sq.ft.)**

Seat and back (220/8 model)	2	45
Seat and back (220/9 model)	2	45

COM yardage and COL square footage requirements may differ from standard requirements due to leather types and/or fabric patterns. The ultimate yardage/square footage will be determined at time of testing. Please refer to Terms and Conditions for COM/COL terms.

**FS-Line  
Cantilever chairs**

Upholstery material

**Features**

One-piece seat and back shell, upholstered  
Stackable 5-high free-standing (212/5 model)  
Stackable 8-high on four-wheeled trolley (212/5 model)

COM	Fabric grade 5	Fabric grade 6*
USD	USD	USD

**212/5 Standard height backrest**

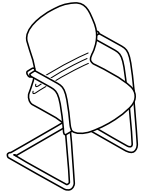

**frame Powder Coated Aluminum <sup>1</sup> / shell Plastic <sup>2</sup>**

seat Upholstered, back Upholstered

1263 1210 1316

**frame Bright Chrome Aluminum / shell Plastic <sup>2</sup>**

seat Upholstered, back Upholstered

1343 1290 1396

*\*Not available in Fabric 62 - Bond or Skai faux leather*

<sup>1</sup> Powder Coat colors: Silver or Black

<sup>2</sup> Shell colors: Black or White

**Additional charges to the chair model**

stackable version (in Bright Chrome finish only)

- - 248

**Accessories**

**USD**

214 Four-wheeled trolley for eight stackable cantilever chairs (leather upholstered chairs cannot be stacked)

1282

**COM/COL Requirements (212/5)**

**COM (yd)**

**COL (sq.ft.)**

Seat and back (212/5 model)

1.5

-

Seat and back (219/51 model)

1.5

-

Seat and back (220/5 model)

2

-

*\* COL pricing and requirements on request*

*COM yardage and COL square footage requirements may differ from standard requirements due to leather types and/or fabric patterns. The ultimate yardage/square footage will be determined at time of testing. Please refer to Terms and Conditions for COM/COL terms.*



FS-Line chair and Timetable table

## 21 range FS-Management

Design: Klaus Franck, Werner Sauer, wiege



### Technical Details

#### Function

Task chairs and armchairs with automatic synchro-adjustment: the seat and backrest automatically tilt to any posture the person adopts. When leaning back, the backrest tension increases proportionately. The person using the chair can infinitely adjust the tension. The front position is lockable by engaging the lever. DIN 4550 compliant gas lift for infinite adjustment of the seat height. Conference/visitor chairs (model 220/62, 220/72) with automatic synchro-adjustment, but without front locking position and without infinite height adjustment.

#### Frame

Die-cast aluminum, bright chrome-plated star base. Twin wheel swivel castors with load-dependent braking, made of black polyamide in accordance with DIN EN 12529 as the standard version for carpets; with gray soft polyurethane facing for hard floors. Castors optionally electrically conductive. Black polyamide glides as the standard version for carpets and in black polyurethane for hard floorings. Die-cast aluminum, bright chrome-plated swivel arms.

#### Seat and back

Steel tube frames with a flexible middle section, covered with elastic mesh. Foam upholstery with additional cushioning. Exchangeable cover with wider stitched fluting. Integral foam armrests, leather-covered with stitched seam.

Fabric Grades

Leather = 74

#### Standards

The FS swivel chairs and armchairs comply with DIN EN 1335, ANSI/BIFMA X 5.1 and other international office chair standards. Depending on the version they also fulfil the requirements of categories B or C of the DIN EN 1335 office chair standard.



**FS Management  
Conference chair**

Upholstery material

**Features**

One-piece seat and back shell, fully upholstered with wider stitched fluting  
Wide stitched fluting  
Pneumatic height adjustment  
Automatic synchro-adjustment, tension control

COL \*  
Leather 74  
**USD USD**

**220/82 Medium-height backrest**



**base Bright Chrome Aluminum / swing arms Bright Chrome Aluminum**  
seat Leather, back Leather

6220 6170

**220/92 High backrest**



**base Bright Chrome Aluminum / swing arms Bright Chrome Aluminum**  
seat Leather, back Leather

7198 7148

\* Not available in Skai faux leather

**COM/COL Requirements (220/81 & 220/91)**

Seat and back (220/81 model)  
Seat and back (220/91 model)

**COM (yd)**

N/A  
N/A

**COL (sq.ft.)**

33  
38

*Please refer to Terms and Conditions for COM/COL terms.*

## 222 range

### Occo SC

Design: Jehs + Laub



#### Technical Details

##### Function

In conference rooms, open-plan meeting areas or company restaurants: Occo SC offers superior comfort, enormous versatility and a vast range of design options in a distinctive design language.

##### Chairs

##### Four-leg frame models 221/10, 221/11, 221/12

Tubular steel frame with textured matte finish coated in white, black, gray, gray-beige, orange-red, blue-gray or bright chrome-plated.

##### Please note:

Coated frame versions are not stackable.

Model 221/10 (shell not upholstered) with four separators made of PUR and frame cover made of plastic (PP) each in dark gray.

Models 221/11 and 221/12 with stacking guard made of plastic (PP) in dark gray.

##### Four-leg frame in solid wood models 221/20, 221/21, 221/22

Seat bearer made of tubular steel in dark gray with a textured matte finish to fit onto the seat shell and to attach the four legs made of solid oak with a natural oiled finish.

##### Four-star base models 221/30, 221/31, 221/32, five-star base models 221/40, 221/41, 221/42

Butted tubular steel with a textured matte finish coated in white, black, gray, gray-beige, orange-red, blue-gray or bright chrome-plated with seat bearer made of moulded flat steel in dark gray with a textured matte finish to attach to the shell. In the case of four-star bases, the steel glides are in dark gray with a textured matte finish. Four-leg and four-star base models are fitted with multipurpose glides for soft and hard floorings. For sensitive flooring, please order with extra felt glides (at no additional charge). Five-star base models 221/40, 221/41, 221/42 with

twin wheel swivel castors with load dependent braking, made of black polypropylene compliant with DIN EN 12529 as the standard version for carpets, optionally with gray polyurethane tire for hard floors.

##### Seat and back

Unitary, ergonomically molded seat shell with cut-out section, made of reinforced through-dyed polypropylene optionally in white, black, gray, gray-beige, orange-red or blue-gray. Models 221/10, 221/20, 221/30, 221/40 optionally with felt seat cushion with anti-slip coating. In anthracite, light mottled, graphite, mango, verde, deep water. Models 221/11, 221/21, 221/31, 221/41, with seat cushion and models 221/12, 221/22, 221/32, 221/42 with padding on the inside made of cut foam in each case.

**Please note:** To ensure quality is maintained we do not offer white leather (74/72). All other standard leather colors are possible. When exposed to ultra violet rays for long periods of time, the colors of plastics can change slightly.

Due to the nature of the material, there are slight differences in the color between white table tops with bonded surfaces and HPL table tops and the white Occo plastic chairs.

Felt is a natural product. Therefore, there can be differences in the color. These differences are not a justified reason for complaint but underscore the material's uniqueness.

##### Standards

Tests being conducted for the GS mark



##### Fabric Grades

- Grade 3 = 37** Racer
- Grade 5 = 54** Pitch
- Grade 6 = 60** Blend
- 63** Auris
- 66** Lona
- 68** Remix 2
- 69** Granit
- Grade 9 = 91** Steelcut Trio 3
- Leather = 74**
- Leather = 87**

**Multi-purpose chair four-leg (Steel legs)**



Seat height **17 <sup>3</sup>/<sub>8</sub>"**  
Overall Height **32 <sup>3</sup>/<sub>4</sub>"**  
Overall Width **22 <sup>1</sup>/<sub>2</sub>"**  
Overall Depth **20 <sup>7</sup>/<sub>8</sub>"**

**Multi-purpose chair four-leg (Oak legs)**



Seat height **17 <sup>3</sup>/<sub>8</sub>"**  
Overall Height **32 <sup>3</sup>/<sub>4</sub>"**  
Overall Width **21 <sup>1</sup>/<sub>4</sub>"**  
Overall Depth **22 <sup>1</sup>/<sub>4</sub>"**

**Multi-purpose swivel chair four-star on glides**



Seat height **17 <sup>3</sup>/<sub>8</sub>"**  
Overall Height **32 <sup>3</sup>/<sub>4</sub>"**  
Overall Width **20 <sup>1</sup>/<sub>4</sub>"**  
Overall Depth **21"**

**Multi-purpose swivel chair five-star on castors**



Seat height **17 <sup>3</sup>/<sub>8</sub>"**  
Overall Height **32 <sup>3</sup>/<sub>4</sub>"**  
Overall Width **26"**  
Overall Depth **24 <sup>7</sup>/<sub>8</sub>"**

## 221 Occo SC Chairs

Wilkhahn

Upholstery material

### Features

Stackable 10-high free-standing (221/10 models with chrome frame only)  
Stackable 8-high free-standing (221/11 models with chrome frame only)  
Coated frame, color-matched with the shell, not stackable

COM	COL	Racer grade 3	Fabric grade 5	Fabric grade 6	Fabric grade 9	Leather 74	Leather 87
USD	USD	USD	USD	USD	USD	USD	USD

### 221/10 Multi-purpose chair four-leg



**frame and legs Powder Coated <sup>1</sup> / shell Plastic <sup>2</sup>**

seat and back Plastic (no upholstery)

465

**frame Bright Chrome Aluminum / shell Plastic <sup>2</sup>**

seat and back Plastic (no upholstery)

465

<sup>1</sup> Frame & leg colors: Powder Coated frame colors always match the shell colors below

<sup>2</sup> Shell colors: White, Black, Gray, Gray Beige, Orange Red or Blue Gray

#### Accessories

**222** Non-slip felt cushion available in 6 colors

96

### 221/11 Multi-purpose chair four-leg with seat cushioning



**frame and legs Powder Coated <sup>1</sup> / shell Plastic <sup>2</sup>**

seat Fabric, back Plastic (non-stackable)

742 925 636 725 759 810 875 1005

**frame and legs Bright Chrome Aluminum / shell Plastic <sup>2</sup>**

seat Fabric, back Plastic (stackable)

742 925 636 725 759 810 875 1005

<sup>1</sup> Frame & leg colors: Powder Coated frame colors always match the shell colors below

<sup>2</sup> Shell colors: White, Black, Gray, Gray Beige, Orange Red or Blue Gray

### 221/12 Multi-purpose chair four-leg with padding on the inside



**frame and legs Powder Coated <sup>1</sup> / shell Plastic <sup>2</sup>**

seat Fabric, back Fabric (non-stackable)

1157 1597 981 1130 1183 1263 1547 1940

**frame and legs Bright Chrome Aluminum / shell Plastic <sup>2</sup>**

seat Fabric, back Fabric (stackable)

1157 1597 981 1130 1183 1263 1547 1940

<sup>1</sup> Frame & leg colors: Powder Coated frame colors always match the shell colors below

<sup>2</sup> Shell colors: White, Black, Gray, Gray Beige, Orange Red or Blue Gray

#### Accessories

186 Transport trolley for 6-10 multi-purpose chairs

USD

661

#### COM/COL Requirements (221/11 & 221/12)

COM (yd)

COL (sq.ft.)

\* Information pending. For exact yardage, please contact your local Wilkhahn representative.

**221 Occo SC  
Chairs**

Upholstery material

**Features**  
Non-stackable

COM	COL	Racer grade 3	Fabric grade 5	Fabric grade 6	Fabric grade 9	Leather 74	Leather 87
USD	USD	USD	USD	USD	USD	USD	USD

**221/20 Multi-purpose chair four-leg**



**legs solid Oak / shell Plastic <sup>1</sup>**  
seat and back Plastic (no upholstery) 810

<sup>1</sup> Shell colors: White, Black, Gray, Gray Beige, Orange Red or Blue Gray

**Accessories**  
**222** Non-slip felt cushion available in 6 colors 96

**221/21 Multi-purpose chair four-leg with seat cushioning**



**legs solid Oak / shell Plastic <sup>1</sup>**  
seat Fabric, back Plastic 1087 1270 981 1070 1104 1155 1220 1350

<sup>1</sup> Shell colors: White, Black, Gray, Gray Beige, Orange Red or Blue Gray

**221/22 Multi-purpose chair four-leg with padding on the inside**



**legs solid Oak / shell Plastic <sup>1</sup>**  
seat Fabric, back Fabric 1502 1942 1326 1475 1528 1608 1892 2285

<sup>1</sup> Shell colors: White, Black, Gray, Gray Beige, Orange Red or Blue Gray

**COM/COL Requirements (221/21 & 221/22)**

**COM (yd)**

**COL (sq.ft.)**

\* Information pending. For exact yardage, please contact your local Wilkhahn representative.

**221 Occo SC  
Chairs**

Upholstery material

	COM	COL	Racer grade 3	Fabric grade 5	Fabric grade 6	Fabric grade 9	Leather 74	Leather 87
	USD	USD	USD	USD	USD	USD	USD	USD

**221/30 Multi-purpose swivel chair four-star on glides**



<b>frame and legs Powder Coated <sup>1</sup> / shell Plastic <sup>2</sup></b> seat and back Plastic (no upholstery) non-stackable	957
<b>frame and legs Bright Chrome Aluminum / shell Plastic <sup>2</sup></b> seat and back Plastic (no upholstery) stackable	957

<sup>1</sup> Frame & leg colors: Powder Coated frame colors always match the shell colors below  
<sup>2</sup> Shell colors: White, Black, Gray, Gray Beige, Orange Red or Blue Gray

<b>Accessories</b> <b>222</b> Non-slip felt cushion available in 6 colors	96
--	----

**221/31 Multi-purpose swivel chair four-star on glides with seat cushioning**



<b>frame and legs Powder Coated <sup>1</sup> / shell Plastic <sup>2</sup></b> seat Fabric, back Plastic (non-stackable)	1234	1417	1128	1217	1251	1302	1367	1497
<b>frame and legs Bright Chrome Aluminum / shell Plastic <sup>2</sup></b> seat Fabric, back Plastic (stackable)	1234	1417	1128	1217	1251	1302	1367	1497

<sup>1</sup> Frame & leg colors: Powder Coated frame colors always match the shell colors below  
<sup>2</sup> Shell colors: White, Black, Gray, Gray Beige, Orange Red or Blue Gray

**221/32 Multi-purpose swivel chair four-star on glides with padding on the inside**



<b>frame and legs Powder Coated <sup>1</sup> / shell Plastic <sup>2</sup></b> seat Fabric, back Fabric	1649	2089	1473	1622	1675	1755	2039	2432
<b>frame and legs Bright Chrome Aluminum / shell Plastic <sup>2</sup></b> seat Fabric, back Fabric	1649	2089	1473	1622	1675	1755	2039	2432

<sup>1</sup> Frame & leg colors: Powder Coated frame colors always match the shell colors below  
<sup>2</sup> Shell colors: White, Black, Gray, Gray Beige, Orange Red or Blue Gray

COM/COL Requirements (221/31 & 221/32)	COM (yd)	COL (sq.ft.)
--	----------	--------------

\* Information pending. For exact yardage, please contact your local Wilkhahn representative.

**221 Occo SC  
Chairs**

Upholstery material

COM	COL	Racer grade 3	Fabric grade 5	Fabric grade 6	Fabric grade 9	Leather 74	Leather 87
USD	USD	USD	USD	USD	USD	USD	USD

**221/40 Multi-purpose swivel chair five-star on castors**



<b>frame and legs Powder Coated <sup>1</sup> / shell Plastic <sup>2</sup></b> seat and back Plastic (no upholstery) non-stackable	981
<b>frame and legs Bright Chrome Aluminum / shell Plastic <sup>2</sup></b> seat and back Plastic (no upholstery) stackable	981

<sup>1</sup> Frame & leg colors: Powder Coated frame colors always match the shell colors below  
<sup>2</sup> Shell colors: White, Black, Gray, Gray Beige, Orange Red or Blue Gray

**Accessories**

<b>222</b> Non-slip felt cushion available in 6 colors	96
--	----

**221/41 Multi-purpose swivel chair five-star on castors with seat cushioning**



<b>frame and legs Powder Coated <sup>1</sup> / shell Plastic <sup>2</sup></b> seat Fabric, back Plastic (non-stackable)	1258	1441	1152	1241	1275	1326	1391	1521
<b>frame and legs Bright Chrome Aluminum / shell Plastic <sup>2</sup></b> seat Fabric, back Plastic (stackable)	1258	1441	1152	1241	1275	1326	1391	1521

<sup>1</sup> Frame & leg colors: Powder Coated frame colors always match the shell colors below  
<sup>2</sup> Shell colors: White, Black, Gray, Gray Beige, Orange Red or Blue Gray

**221/42 Multi-purpose swivel chair five-star on castors with padding on the inside**



<b>frame and legs Powder Coated <sup>1</sup> / shell Plastic <sup>2</sup></b> seat Fabric, back Fabric (non-stackable)	1673	2113	1497	1646	1699	1779	2063	2456
<b>frame and legs Bright Chrome Aluminum / shell Plastic <sup>2</sup></b> seat Fabric, back Fabric (stackable)	1673	2113	1497	1646	1699	1779	2063	2456

<sup>1</sup> Frame & leg colors: Powder Coated frame colors always match the shell colors below  
<sup>2</sup> Shell colors: White, Black, Gray, Gray Beige, Orange Red or Blue Gray

**COM/COL Requirements (221/41 & 221/42)**

**COM (yd)**

**COL (sq.ft.)**

\* Information pending. For exact yardage, please contact your local Wilkhahn representative.

## 222 range

### Occo

Design: Jehs + Laub



#### Technical Details

##### Function

In conference rooms, open-plan meeting areas or cafes: Occo offers superior comfort, enormous versatility and a vast range of design options, all in a distinctive design language.

##### Chairs

###### Four-leg frame models 222/10, 222/11, 222/12

Tubular steel frame with textured matte finish powder coated in white, black, gray, gray beige, orange red, blue gray or bright chrome-plated.

**Please note:** powder coated frame versions are not stackable. Model 222/10 (shell with no upholstery) with four separators made of PUR and dark gray plastic (PP) frame cover.

Models 222/11 and 222/12 with stacking guard made of dark gray plastic (PP) with a textured matte finish.

###### Four-leg frame in solid wood models 222/20, 222/21, 222/22

Dark gray tubular steel seat bearer with textured matte finish fits onto the seat shell and attaches to four solid oak legs with a natural oiled finish.

###### Four-star base models 222/30, 222/31, 222/32

###### Five star base models 220/40, 222/41, 222/42

Butted tubular steel with a textured matte finish powder coated in white, black, gray, gray beige, orange red, blue gray or bright chrome-plated with seat bearer made of dark gray molded flat steel with a textured matte finish to attach to the shell. Four-star bases have dark gray steel glides with textured matte finish.

Four-leg and four-star base models are fitted with multi-purpose glides for soft and hard floorings. For sensitive floorings order with extra felt glides (at no additional charge).

Five-star base models 220/40, 222/41, 222/42 with twin-wheel swivel castors with load-dependent braking, made of black polypropylene compliant with DIN EN 12529 is the standard version for carpets. Gray polyurethane tire option available for hard floors.

##### Seat and back

Unitary, ergonomically molded seat shell with cut-out section, made of reinforced through-dyed polypropylene available in white, black, gray, gray beige, orange red or blue gray.

Models 222/10, 222/20, 222/30, 222/40 have optionally felt seat cushion (with anti-slip coating) in anthracite, light mottled, graphite, mango, verde, deep water. Models 222/11, 222/21, 222/31, 222/41, with seat cushion and models 222/12, 222/22, 222/32, 222/42 with padding on inside made of cut foam.

**Please note:** To ensure quality we don't offer white leather (74/72). All other standard leather colors are possible.

##### Fabric Grades

**Grade 3 = 37** Racer  
**Grade 5 = 54** Pitch  
**Grade 6 = 60** Blend  
63 Auris  
66 Lona  
68 Remix 2  
69 Granit  
**Grade 9 = 91** Steelcut  
Trio 3

**Leather = 74**  
**Leather = 87**



Occo chairs and Occo table

**Multi-purpose chair four-leg (Steel legs)**



Seat height **17 <sup>3</sup>/<sub>8</sub>"**  
Overall Height **32 <sup>1</sup>/<sub>4</sub>"**  
Overall Width **22 <sup>1</sup>/<sub>2</sub>"**  
Overall Depth **22 <sup>3</sup>/<sub>4</sub>"**

**Multi-purpose chair four-leg (Oak legs)**



Seat height **17 <sup>3</sup>/<sub>8</sub>"**  
Overall Height **32 <sup>1</sup>/<sub>4</sub>"**  
Overall Width **22 <sup>1</sup>/<sub>2</sub>"**  
Overall Depth **21 <sup>5</sup>/<sub>8</sub>"**

**Multi-purpose swivel chair four-star on glides**



Seat height **17 <sup>3</sup>/<sub>8</sub>"**  
Overall Height **32 <sup>1</sup>/<sub>4</sub>"**  
Overall Width **22 <sup>1</sup>/<sub>2</sub>"**  
Overall Depth **22"**

**Multi-purpose swivel chair five-star on castors**



Seat height **17 <sup>3</sup>/<sub>8</sub>"**  
Overall Height **32 <sup>1</sup>/<sub>4</sub>"**  
Overall Width **22 <sup>1</sup>/<sub>2</sub>"**  
Overall Depth **22"**

## 222 Occo Chairs

Upholstery material

### Features

Stackable 10-high free-standing (222/10 models with chrome frame only)  
Stackable 6-high free-standing (222/11 models with chrome frame only)  
Stackable 4-high free-standing (222/12 models with chrome frame only)

USD	COM	USD	COL	USD	Racer grade 3	USD	Fabric grade 5	USD	Fabric grade 6	USD	Fabric grade 9	USD	Leather 74	USD	Leather 87
-----	-----	-----	-----	-----	---------------	-----	----------------	-----	----------------	-----	----------------	-----	------------	-----	------------

### 222/10 Multi-purpose chair four-leg



<b>frame and legs Powder Coated <sup>1</sup> / shell Plastic <sup>2</sup></b> seat and back Plastic (no upholstery)	465
<b>frame Bright Chrome Aluminum / shell Plastic <sup>2</sup></b> seat and back Plastic (no upholstery)	465

<sup>1</sup> Frame & leg colors: Powder Coated frame colors always match the shell colors below  
<sup>2</sup> Shell colors: White, Black, Gray, Gray Beige, Orange Red or Blue Gray

#### Accessories

<b>222</b> Non-slip felt cushion available in 6 colors	96
--	----

### 222/11 Multi-purpose chair four-leg with seat cushion



<b>frame and legs Powder Coated <sup>1</sup> / shell Plastic <sup>2</sup></b> seat Fabric, back Plastic (non-stackable)	742	925	636	725	759	810	875	1005
<b>frame and legs Bright Chrome Aluminum / shell Plastic <sup>2</sup></b> seat Fabric, back Plastic (stackable)	742	925	636	725	759	810	875	1005

<sup>1</sup> Frame & leg colors: Powder Coated frame colors always match the shell colors below

<sup>2</sup> Shell colors: White, Black, Gray, Gray Beige, Orange Red or Blue Gray

### 222/12 Multi-purpose chair four-leg with padding on the inside



<b>frame and legs Powder Coated <sup>1</sup> / shell Plastic <sup>2</sup></b> seat Fabric, back Fabric (non-stackable)	1157	1597	981	1130	1183	1263	1547	1940
<b>frame and legs Bright Chrome Aluminum / shell Plastic <sup>2</sup></b> seat Fabric, back Fabric (stackable)	1157	1597	981	1130	1183	1263	1547	1940

<sup>1</sup> Frame & leg colors: Powder Coated frame colors always match the shell colors below

<sup>2</sup> Shell colors: White, Black, Gray, Gray Beige, Orange Red or Blue Gray

#### Accessories

186 Transport trolley for 8 multi-purpose chairs	USD	687
--	-----	-----

#### COM/COL Requirements (222/11 & 222/12)

	COM (yd)	COL (sq.ft.)
Seat only (222/11 model)	0.6/chair, or 0.6/two chairs	5.2/chair, or 10.4/two chairs
Seat and back (222/12 model)	1/chair, or 1.6/two chairs	18/chair, or 36/two chairs

Please refer to Terms and Conditions for COM/COL terms.

## 222 Occo Chairs

Wilkhahn

Upholstery material

### Features

Non-stackable

COM	COL	Racer grade 3	Fabric grade 5	Fabric grade 6	Fabric grade 9	Leather 74	Leather 87
USD	USD	USD	USD	USD	USD	USD	USD

### 222/20 Multi-purpose chair four-leg



#### legs solid Oak / shell Plastic <sup>1</sup>

seat and back Plastic (no upholstery)

810

<sup>1</sup> Shell colors: White, Black, Gray, Gray Beige, Orange Red or Blue Gray

#### Accessories

**222** Non-slip felt cushion available in 6 colors

96

### 222/21 Multi-purpose chair four-leg with seat cushion



#### legs solid Oak / shell Plastic <sup>1</sup>

seat Fabric, back Plastic

1087 1270 981 1070 1104 1155 1220 1350

<sup>1</sup> Shell colors: White, Black, Gray, Gray Beige, Orange Red or Blue Gray

### 222/22 Multi-purpose chair four-leg with padding on the inside



#### legs solid Oak / shell Plastic <sup>1</sup>

seat Fabric, back Fabric

1502 1942 1326 1475 1528 1608 1892 2285

<sup>1</sup> Shell colors: White, Black, Gray, Gray Beige, Orange Red or Blue Gray

### COM/COL Requirements (222/21 & 222/22)

### COM (yd)

### COL (sq.ft.)

Seat only (222/21 model)

0.6/chair, or 0.6/two chairs

5.2/chair, or 10.4/two chairs

Seat and back (222/22 model)

1/chair, or 1.6/two chairs

18/chair, or 36/two chairs

Please refer to Terms and Conditions for COM/COL terms.

**222 Occo  
Chairs**

Upholstery material

COM	COL	Racer grade 3	Fabric grade 5	Fabric grade 6	Fabric grade 9	Leather 74	Leather 87
USD	USD	USD	USD	USD	USD	USD	USD

**222/30 Multi-purpose swivel chair four-star on glides**



**frame and legs Powder Coated <sup>1</sup> / shell Plastic <sup>2</sup>**

seat and back Plastic (no upholstery) 957

**frame and legs Bright Chrome Aluminum / shell Plastic <sup>2</sup>**

seat and back Plastic (no upholstery) 957

<sup>1</sup> Frame & leg colors: Powder Coated frame colors always match the shell colors below

<sup>2</sup> Shell colors: White, Black, Gray, Gray Beige, Orange Red or Blue Gray

**Accessories**

**222** Non-slip felt cushion available in 6 colors 96

**222/31 Multi-purpose swivel chair four-star on glides with seat cushion**



**frame and legs Powder Coated <sup>1</sup> / shell Plastic <sup>2</sup>**

seat Fabric, back Plastic 1234 1417 1128 1217 1251 1302 1367 1497

**frame and legs Bright Chrome Aluminum / shell Plastic <sup>2</sup>**

seat Fabric, back Plastic 1234 1417 1128 1217 1251 1302 1367 1497

<sup>1</sup> Frame & leg colors: Powder Coated frame colors always match the shell colors below

<sup>2</sup> Shell colors: White, Black, Gray, Gray Beige, Orange Red or Blue Gray

**222/32 Multi-purpose swivel chair four-star on glides with padding on the inside**



**frame and legs Powder Coated <sup>1</sup> / shell Plastic <sup>2</sup>**

seat Fabric, back Fabric 1649 2089 1473 1622 1675 1755 2039 2432

**frame and legs Bright Chrome Aluminum / shell Plastic <sup>2</sup>**

seat Fabric, back Fabric 1649 2089 1473 1622 1675 1755 2039 2432

<sup>1</sup> Frame & leg colors: Powder Coated frame colors always match the shell colors below

<sup>2</sup> Shell colors: White, Black, Gray, Gray Beige, Orange Red or Blue Gray

**COM/COL Requirements (222/31 & 222/32)**

**COM (yd)**

**COL (sq.ft.)**

Seat only (222/31 model)	0.6/chair, or 0.6/two chairs	5.2/chair, or 10.4/two chairs
Seat and back (222/32 model)	1/chair, or 1.6/two chairs	18/chair, or 36/two chairs

Please refer to Terms and Conditions for COM/COL terms.

**222 Occo  
Chairs**

Upholstery material

COM	COL	Racer grade 3	Fabric grade 5	Fabric grade 6	Fabric grade 9	Leather 74	Leather 87
USD	USD	USD	USD	USD	USD	USD	USD

**222/40 Multi-purpose swivel chair five-star on castors**



<b>frame and legs Powder Coated <sup>1</sup> / shell Plastic <sup>2</sup></b> seat and back Plastic (no upholstery)	981
<b>frame and legs Bright Chrome Aluminum / shell Plastic <sup>2</sup></b> seat and back Plastic (no upholstery)	981

<sup>1</sup> Frame & leg colors: Powder Coated frame colors always match the shell colors below  
<sup>2</sup> Shell colors: White, Black, Gray, Gray Beige, Orange Red or Blue Gray

<b>Accessories</b> <b>222</b> Non-slip felt cushion available in 6 colors	96
--	----

**222/41 Multi-purpose swivel chair five-star on castors with seat cushion**



<b>frame and legs Powder Coated <sup>1</sup> / shell Plastic <sup>2</sup></b> seat Fabric, back Plastic	1258	1441	1152	1241	1275	1326	1391	1521
<b>frame and legs Bright Chrome Aluminum / shell Plastic <sup>2</sup></b> seat Fabric, back Plastic	1258	1441	1152	1241	1275	1326	1391	1521

<sup>1</sup> Frame & leg colors: Powder Coated frame colors always match the shell colors below  
<sup>2</sup> Shell colors: White, Black, Gray, Gray Beige, Orange Red or Blue Gray

**222/42 Multi-purpose swivel chair five-star on castors with padding on the inside**



<b>frame and legs Powder Coated <sup>1</sup> / shell Plastic <sup>2</sup></b> seat Fabric, back Fabric	1673	2113	1497	1646	1699	1779	2063	2456
<b>frame and legs Bright Chrome Aluminum / shell Plastic <sup>2</sup></b> seat Fabric, back Fabric	1673	2113	1497	1646	1699	1779	2063	2456

<sup>1</sup> Frame & leg colors: Powder Coated frame colors always match the shell colors below  
<sup>2</sup> Shell colors: White, Black, Gray, Gray Beige, Orange Red or Blue Gray

COM/COL Requirements (222/41 & 222/42)	COM (yd)	COL (sq.ft.)
Seat only (222/41 model)	0.6/chair, or 0.6/two chairs	5.2/chair, or 10.4/two chairs
Seat and back (222/42 model)	1/chair, or 1.6/two chairs	18/chair, or 36/two chairs

Please refer to Terms and Conditions for COM/COL terms.



Occo chairs and Occo table

## 230 range

Design: Andreas Störiko



### Technical Details

#### Function

Stylish and coherently designed, multi-purpose furnishing range for meetings, consultations and seminars, in showrooms and event spaces, areas for breaks, lounges and bistros, as well as libraries, internet cafés or a home office.

#### Skid-base chair

Light, transparent, stackable multi-purpose chair for meetings, consultations, seminars and large-scale events. Very compact, form-fit stacking, with each chair adding only  $\frac{3}{4}$ " to the height of the stack due to self-engaging, covered seat and back frames (total height of 15 stacked chairs is  $41\frac{3}{4}$ ". Weight 11.24 lb only (without armrests), 11.9 lb with armrests.

Skid-base chair, optionally with seat cushion, available as a stackable or a non-stackable version. The stackable types have extra bumpers and can be stacked extremely compactly and in a form-fit manner.

#### Chairs

##### Frame

##### Skid-base chair

Skid base in round steel rod, diameter  $\frac{1}{2}$ ", bright chrome-plated. The skid base supports the front seat frame and integrates with the backrest frame at the rear. On request, with additional glides in black polyamide for soft floors, optionally with felt insert.

##### Task chair and visitor chair

Four-star base (visitor chair) or five-star base (task chair) in die-cast aluminum, bright chrome-plated. Visitor chair with glides in black polyamide (for soft floors) or black polyurethane (for hard floors), optionally with additional felt insert. Swivel chair with twin wheel swivel castors in black polyamide with load dependent braking (for soft floors) or with a soft lining (for hard floors); anti-static castors on request. Fixed height swivel pedestal with contact suppression feature (visitor chair) or additional infinitely height adjustable pedestal (swivel chair), bright chrome-plated steel tube.

#### Seat and back

Seat and back frames in high-performance, reinforced fiberglass polyamide, optionally through-dyed in black, gray or white, with resilient coated polyester membrane optionally in the same color as the seat and back frames. Optionally also two-tone membrane in the colors copper/black or silver/black available for seat and back frames through-dyed in black only.

Back frame optionally without armrests or with armrests in matching material and color. Optionally with a polypropylene seat shell and cut-foam seat cushion. Stackable types (only models 230/1 and 230/2) with reinforced fiberglass polyamide bumper that color matches the seat and backrest frame. Swivel and visitor chairs (mods. 232/1, 232/2, 231/1, 231/2) optionally with cut foam seat cushion, with stitched fluting cover, upholstery thickness 0.39".

#### Accessories

##### Models 237/2, 4, 5, 6

Optionally for skid-base chair, retractable inline connector made of matte, chrome-plated flat steel. When linked, chairs with armrests must alternate with chairs without armrests. Stacking trolley allowing compact storage in steel tube, coated black, with four heavy duty wheels for hard and soft floors, two of which are lockable directional wheels.

#### Standards

230 range stackable chairs conform to the Office Chair Standard DIN EN 13761.



Fabric Grades

- Grade 4 = 47** Nova
- Grade 5 = 54** Pitch
- Grade 6 = 60** Blend
  - 63** Auris
  - 66** Lona
  - 68** Remix 2
- Grade 9 = 91** Steelcut Trio 3

**GREENGUARD™**

Virtually all Wilkhahn products undergo testing and certification in accordance with GREENGUARD. The Greenguard Environmental Institute is an independent institution in the US that certifies products with regard to their suitability for interiors. Besides environmental aspects, special focus is on ensuring that products do not emit any pollutants that might be harmful to health.



230 range chairs with Confair table

**Multi-purpose chair (without armrests)**

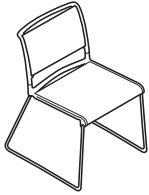

Seat height **17 <sup>3</sup>/<sub>8</sub>"**  
 Overall Height **30 <sup>3</sup>/<sub>4</sub>"**  
 Overall Width **21 <sup>1</sup>/<sub>4</sub>"**  
 Overall Depth **22 <sup>7</sup>/<sub>8</sub>"**

**Swivel chair (without armrests)**



Seat height **15 <sup>3</sup>/<sub>4</sub>" - 20 <sup>1</sup>/<sub>2</sub>"**  
 Overall Height **29 <sup>7</sup>/<sub>8</sub>" - 34 <sup>5</sup>/<sub>8</sub>"**  
 Overall Width **25 <sup>5</sup>/<sub>8</sub>"**  
 Overall Depth **25 <sup>1</sup>/<sub>4</sub>"**

**Multi-purpose chair (with armrests)**

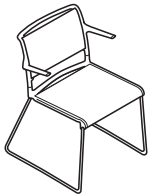

Seat height **17 <sup>3</sup>/<sub>8</sub>"**  
 Overall Height **30 <sup>3</sup>/<sub>4</sub>"**  
 Overall Width **23 <sup>1</sup>/<sub>4</sub>"**  
 Overall Depth **22 <sup>7</sup>/<sub>8</sub>"**

**Task chair (with armrests)**



Seat height **15 <sup>3</sup>/<sub>4</sub>" - 20 <sup>1</sup>/<sub>2</sub>"**  
 Overall Height **29 <sup>7</sup>/<sub>8</sub>" - 34 <sup>5</sup>/<sub>8</sub>"**  
 Overall Width **25 <sup>5</sup>/<sub>8</sub>"**  
 Overall Depth **25 <sup>1</sup>/<sub>4</sub>"**

**Counter/bar height (without armrests)**

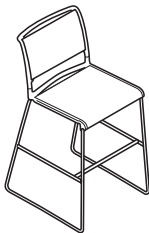

Seat height **27 <sup>1</sup>/<sub>8</sub>"**  
 Overall Height **41 <sup>3</sup>/<sub>8</sub>"**  
 Overall Width **21 <sup>1</sup>/<sub>4</sub>"**  
 Overall Depth **24"**

**Trolley with 20 stacked multi-purpose chairs**

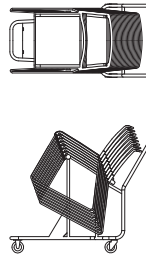

Overall Height **60"**  
 Overall Width **27"**  
 Overall Depth **47"**

**Counter/bar height (with armrests)**

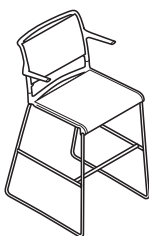

Seat height **27 <sup>1</sup>/<sub>8</sub>"**  
 Overall Height **41 <sup>3</sup>/<sub>8</sub>"**  
 Overall Width **23 <sup>1</sup>/<sub>4</sub>"**  
 Overall Depth **24"**

**15 stacked multi-purpose chairs on floor**

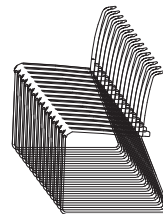

Overall Height **45"**  
 Overall Width **24"**  
 Overall Depth **36"**

## 230 range Chairs

Upholstery material

### Features

Lightweight construction  
Stackable 15-high free-standing (230/1 & 230/2 models without seat upholstery)  
Stackable 10-high free-standing (230/1 & 230/2 models with seat upholstery)

	Mesh	Fabric grade 4	fabric grade 5	Fabric grade 6 *	Fabric grade 9
	USD	USD	USD	USD	USD

### 230/1 Multi-purpose chair

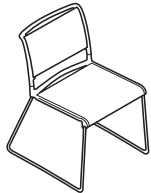

**frame Bright Chrome Aluminum <sup>1</sup> / shell Plastic <sup>2</sup>**

seat Mesh, back Mesh <sup>2</sup>

824 - - - -

**frame Bright Chrome Aluminum <sup>1</sup> / shell Plastic <sup>2</sup>**

seat Fabric, back Mesh <sup>2</sup>

- 1092 1120 1159 1217

<sup>1</sup> Shell colors: Black, Gray or White

<sup>2</sup> Mesh colors: Black, Gray, White, Copper/Black or Silver/Black  
(for Copper/Black or Silver/Black, please see additional charge below)

### 230/2 Multi-purpose chair

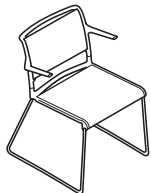

**frame Bright Chrome Aluminum <sup>1</sup> / shell Plastic <sup>2</sup>**

seat Mesh, back Mesh <sup>2</sup>

916 - - - -

**frame Bright Chrome Aluminum <sup>1</sup> / shell Plastic <sup>2</sup>**

seat Fabric, back Mesh <sup>2</sup>

- 1184 1212 1251 1309

<sup>1</sup> Shell colors: Black, Gray or White

<sup>2</sup> Mesh colors: Black, Gray, White, Copper/Black or Silver/Black  
(for Copper/Black or Silver/Black, please see additional charge below)

\* Not available in Skai faux leather

### Additional charges specific to range

		USD
<b>Shell:</b>	1. a) Polyester Mesh material in Copper/Black (with Black frame only) or Silver/Black (with Black frame only)	53
	2. a) higher backrest (overall chair height 31 1/2")	39
<b>Frame:</b>	1. a) glides for soft floors; or	19
	b) glides with felt insert	29
	2. a) outdoor version	29
<b>Other:</b>	1. a) in-line connector	101

### Accessories

	USD
232 Four-wheeled trolley for 20 stackable multi-purpose chairs [15 with seat upholstery]	1328
234 Seat/row number clip	22
235 Sheets of self-adhesive labels for numbering: 1 set (1-400 for seats and 1-100 for rows)	43

## 230 range Chairs

Wilkhahn

Upholstery material

### Features

Lightweight construction  
Footrest

Mesh	Fabric grade 4	fabric grade 5	fabric grade 9	Fabric grade 6 *
USD	USD	USD	USD	USD

### 230/5 Counter/bar height chair

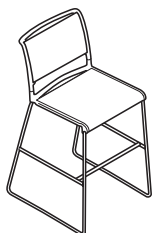

**frame Bright Chrome Aluminum / shell Plastic <sup>1</sup>**

seat Mesh, back Mesh <sup>2</sup>

1094 - - - -

**frame Bright Chrome Aluminum / shell Plastic <sup>1</sup>**

seat Fabric, back Mesh <sup>2</sup>

- 1323 1352 1381 1424

<sup>1</sup> Shell colors: Black, Gray or White

<sup>2</sup> Mesh colors: Black, Gray, White, Copper/Black or Silver/Black  
(for Copper/Black or Silver/Black, please see additional charge below)

### 230/6 Counter/bar height chair

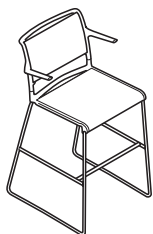

**frame Bright Chrome Aluminum / shell Plastic <sup>1</sup>**

seat Mesh, back Mesh <sup>2</sup>

1186 - - - -

**frame Bright Chrome Aluminum / shell Plastic <sup>1</sup>**

seat Fabric, back Mesh <sup>2</sup>

- 1415 1444 1473 1516

<sup>1</sup> Shell colors: Black, Gray or White

<sup>2</sup> Mesh colors: Black, Gray, White, Copper/Black or Silver/Black  
(for Copper/Black or Silver/Black, please see additional charge below)

\* Not available in Skai faux leather

### Additional charges specific to range

		USD
<b>Shell:</b>	1. a) Polyester Mesh material in Copper/Black (with Black frame only) or Silver/Black (with Black frame only)	53
<b>Frame:</b>	1. a) glides for soft floors; or	19
	b) glides with felt insert	29
	2. a) outdoor version	29

**230 range**  
**Task/visitor chairs**

Upholstery material

**Features**

Lightweight construction  
 Pneumatic height adjustment

**USD**

**232/1 Swivel chair**



**base Bright Chrome Aluminum / shell Plastic <sup>1</sup>**  
 seat Mesh, back Mesh <sup>2</sup>

1321

<sup>1</sup> Shell colors: Black, Gray or White  
<sup>2</sup> Mesh colors: Black, Gray, White, Copper/Black or Silver/Black  
 (for Copper/Black or Silver/Black, please see additional charge below)

**232/2 Swivel chair**



**base Bright Chrome Aluminum / shell Plastic <sup>1</sup>**  
 seat Mesh, back Mesh <sup>2</sup>

1412

<sup>1</sup> Shell colors: Black, Gray or White  
<sup>2</sup> Mesh colors: Black, Gray, White, Copper/Black or Silver/Black  
 (for Copper/Black or Silver/Black, please see additional charge below)

**Additional charges specific to range**

**USD**

<b>Frame:</b>	1. a) Polyester mesh material in copper/black (with black frame only) or silver/black (with black frame only)	53
	2. a) seat cushion with cover with stitched fluting (in combination with upholstery material 47 Nova only)	270
	3. a) higher backrest (overall chair height 32 1/4")	39
<b>Other:</b>	1. a) anti-static castors	95

All swivel chairs are fitted with hard castors for soft floors (e.g. carpet). For hard floors (e.g. stone, wood), please specify soft castors when ordering (no additional charge). All visitor chairs are fitted with glides for soft floors (e.g. carpet). For hard floors (e.g. stone), please specify soft glides; for wooden floors, please specify additional felt insert when ordering (both with no additional charge).

**82**



230 range chairs and 230 range tables



230 range



230 range

## 230-S range

Design: Andreas Störiko



### Technical Details

#### Function

Lightweight stackable multi-purpose chair with transparent slats and membranes. Ideal for canteens, cafés, showrooms, (semi) public lobbies or multi-purpose spaces. Very compact and form-fit stacking possible with just 0.8" more space taken per chair due to the design of the seat and back frame (total height 43" when 15 chairs are stacked). Weighs just 13 lb. (without armrests) or 13.67 lb. (with armrests). Multi-purpose chair optionally available with cushioning and as a stackable and non-stackable version. The stackable types have extra bumpers and can be stacked extremely compactly in a form-fit manner.

#### Counter/bar chair

Stylish bar stool with transparent slats and membranes, including a backrest and footrest, optionally with cushioning.

#### Chairs

##### Frame

##### Multi-purpose chair

Multi-purpose chair: skid base made of steel tubing, 1/2" in diameter, bright chrome-plated, supports the seat frame at the front and continues at the rear through the seat frame to the back frame. Optionally available with additional black polyamide glides for soft flooring, with extra felt on request.

Please note: when ordering inline connector 238, multi-purpose glides are automatically applied, optionally with extra felt for flooring that easily scratches.

Please note: Chrome base may be treated for outdoor use upon special request!

##### Counter/bar chair

Like the multi-purpose chair, but can't be stacked, extra strength provided by bright chrome-plated flat steel stretchers (0.63" x 0.24") and a footrest slightly further back made of round steel tubing.

#### Seat and back

The seat and back frame are made of very strong, reinforced fiberglass polyamide, optionally through-dyed in black or white. The plastic membrane is made of through-dyed polyamide like the seat and back frame. Optionally with or without armrests in the same material or color. Optionally with cut foam seat cushioning. Stackable types (only models 233/1 and 233/2) with reinforced fiberglass polyamide bumper that color-matches the seat and backrest frame.

#### Accessories

Optionally for multi-purpose chair models 233/1, 233/2: inline connectors only in conjunction with multi-purpose black POM (polyoxymethylene) glides for hard and soft floorings or with extra felt for flooring that easily scratches. Chairs with armrests can only be linked alternately with chairs with no armrests. Stackable four-wheeled trolley made of black-coated steel tubing with four ball-bearing mounted wheels for hard and soft floorings, two of which are lockable directional wheels.

#### Standards

320-S chairs conform to DIN EN 13761, DIN EN 16139 and ANSI/BIFMA X 5.1.



Fabric Grades

- Grade 4 = 47** Nova
- Grade 5 = 54** Pitch
- Grade 6 = 60** Blend
  - 63** Auris
  - 66** Lona
  - 68** Remix 2
- Grade 9 = 91** Steelcut Trio 3

**GREENGUARD™**

Virtually all Wilkhahn products undergo testing and certification in accordance with GREENGUARD. The Greenguard Environmental Institute is an independent institution in the US that certifies products with regard to their suitability for interiors. Besides environmental aspects, special focus is on ensuring that products do not emit any pollutants that might be harmful to health.



230-S chairs

## 230-S range Chairs

Wilkhahn

Upholstery material

### Features

Lightweight construction  
Stackable 15-high free-standing (without seat upholstery)  
Stackable 10-high free-standing (with seat upholstery)

Membrane	Fabric grade 4	fabric grade 5	Fabric grade 6 *	Fabric grade 9
USD	USD	USD	USD	USD

### 233/1 Multi-purpose chair

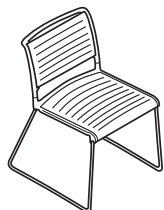

**frame Bright Chrome Aluminum <sup>1</sup> / shell Plastic <sup>2</sup>**

seat Membrane, back Membrane <sup>2</sup>

547 - - - -

**frame Bright Chrome Aluminum <sup>1</sup> / shell Plastic <sup>2</sup>**

seat Fabric, back Membrane <sup>2</sup>

- 846 880 909 952

<sup>1</sup> Shell colors: Black, Gray or White

<sup>2</sup> Mesh colors: Black, Gray, White, Copper/Black or Silver/Black  
(for Copper/Black or Silver/Black, please see additional charge below)

### 233/2 Multi-purpose chair



**frame Bright Chrome Aluminum <sup>1</sup> / shell Plastic <sup>2</sup>**

seat Membrane, back Membrane <sup>2</sup>

639 - - - -

**frame Bright Chrome Aluminum <sup>1</sup> / shell Plastic <sup>2</sup>**

seat Fabric, back Membrane <sup>2</sup>

- 938 972 1001 1044

<sup>1</sup> Shell colors: Black, Gray or White

<sup>2</sup> Mesh colors: Black, Gray, White, Copper/Black or Silver/Black  
(for Copper/Black or Silver/Black, please see additional charge below)

\* Not available in Skai faux leather

### Additional charges specific to range

USD

<b>Shell:</b>	1. a) higher backrest (overall chair height 31 1/2")	39
<b>Frame:</b>	1. a) glides for soft floors; or b) glides with felt insert	19 29
<b>Other:</b>	1. a) in-line connector (only possible in combination with any of the glides above)	77

### Accessories

USD

232 Four-wheeled trolley for twenty stackable multi-purpose chairs	1328
234 Seat/row number clip	22
235 Sheets of self-adhesive labels for numbering: 1 set (1-400 for seats and 1-100 for rows)	43

## 230-S range Chairs

Upholstery material

### Features

Lightweight construction  
Footrest

Membrane	Fabric grade 4	fabric grade 5	Fabric grade 6 *	Fabric grade 9
USD	USD	USD	USD	USD

### 233/4 Counter/bar height chair



**frame Bright Chrome Aluminum <sup>1</sup> / shell Plastic <sup>2</sup>**

seat Membrane, back Membrane <sup>2</sup>

812 - - - -

**frame Bright Chrome Aluminum <sup>1</sup> / shell Plastic <sup>2</sup>**

seat Fabric, back Membrane <sup>2</sup>

- 1072 1101 1135 1186

<sup>1</sup> Shell colors: Black, Gray or White

<sup>2</sup> Mesh colors: Black, Gray, White, Copper/Black or Silver/Black  
(for Copper/Black or Silver/Black, please see additional charge below)

### 233/6 Counter/bar height chair



**frame Bright Chrome Aluminum <sup>1</sup> / shell Plastic <sup>2</sup>**

seat Membrane, back Membrane <sup>2</sup>

904 - - - -

**frame Bright Chrome Aluminum <sup>1</sup> / shell Plastic <sup>2</sup>**

seat Fabric, back Membrane <sup>2</sup>

- 1164 1193 1227 1278

<sup>1</sup> Shell colors: Black, Gray or White

<sup>2</sup> Mesh colors: Black, Gray, White, Copper/Black or Silver/Black  
(for Copper/Black or Silver/Black, please see additional charge below)

\* Not available in Skai faux leather

## 238 range

### Aula

Design: Wolfgang C.R. Mezger



#### Technical Details

##### Function

Lightweight, stackable, multipurpose all-plastic chair. The form, elasticity and ergonomic design of the seat shell provide excellent comfort even when people are sitting on it for longer periods of time. Five colors (two of which are on request) and four types of upholstery tap into a wide range of furnishing and design options for multipurpose facilities, cafés, seminar rooms, conference areas or co-working spaces.

##### Frame / armrests

All-plastic frame made of through-dyed, reinforced fibreglass ultramid in white, black, gray, gray-beige and blue-gray on request, with universal glides, optionally with felt glides, optionally with or without armrests in the same material and color.

##### Seat and backrest

Unitary, ergonomically molded seat shell with through-dyed, reinforced fibreglass polypropylene to match the frame and armrests in white, black, gray, gray-beige plus blue-gray on request. Model 238/11 with seat cushioning, model 238/12 with padding on the inside (unitary seat-backrest cushioning) each with replaceable upholstery element made of plywood and breathable polyurethane foam. Model 238/13, fully upholstered, plywood shell with unitary seat-backrest cushioning made of polyurethane foam, shell fully covered with fabric.

##### Accessories

Permanent inline connector made of black zinc-plated bent steel, only to link chairs without armrests (retrofitable). Adjustable, pull-out inline connector made of black zinc-plated bent steel, with clip made of reinforced fibreglass polyamide in anthracite for variable linkage of chairs with armrests and chairs with and without armrests (retrofitable).

Magnetic clip for seat and row numbering made of plastic in anthracite, can be slotted onto the frame on the right or the left. Number tags with white numbers on anthracite sheet steel. Fold-up writing tablet: pad made of black HPL, connector made of black plastic (retrofitable). Only for chairs with armrests, stacking capabilities are retained.

##### Dimensions, weights

Chair without armrests:  
Seating height 17<sup>3</sup>/<sub>4</sub>" , total height 31<sup>7</sup>/<sub>8</sub>" , width 21<sup>5</sup>/<sub>8</sub>" , depth 22<sup>7</sup>/<sub>16</sub>"  
Chair with armrests:  
Seating height 17<sup>3</sup>/<sub>4</sub>" , total height 31<sup>7</sup>/<sub>8</sub>" , armrest height 26<sup>3</sup>/<sub>8</sub>" , width 24<sup>7</sup>/<sub>8</sub>" , depth 22<sup>7</sup>/<sub>16</sub>"  
Weight:  
13.2 lbs without armrests,  
14.9 lbs with armrests

Maximum number of chairs that can be stacked:  
16 free-standing, stacking height 83"  
10 on a four-wheeled trolley, stacking height 72"

Height between chairs when stacked: 3<sup>1</sup>/<sub>2</sub>"  
Center-to-center distances:  
When linked without armrests: 21<sup>5</sup>/<sub>8</sub>"  
When linked with and without armrests: 23<sup>5</sup>/<sub>8</sub>"  
When linked with armrests: 25<sup>1</sup>/<sub>16</sub>"

##### Standards

Based on the DIN EN 16139 office chair standard, up to 10 chairs can be stacked vertically. Tests are being conducted to obtain the ANSI Bifma standard and GS mark.

##### Please note

Stacking the plastic chairs can cause shine and pressure marks.

##### Fabric Grades

**Grade 3 = 37** Racer  
**Grade 4 = 47** Nova  
**Grade 5 = 54** Pitch  
**Grade 6 = 60** Blend  
**62** Bond  
**63** Auris  
**66** Lona  
**68** Remix 2  
**69** Granit  
**Grade 9 = 91** Steelcut Trio 3  
**Leather = 74**





Aula chairs and mAx table



Aula

**Aula**  
**Dimensions**

**Multi-purpose chair (without armrests)**



Seat height **17 3/4"**  
 Overall Height **31 7/8"**  
 Overall Width **21 5/8"**  
 Overall Depth **22 1/2"**

**Multi-purpose chair (with armrests)**



Seat height **17 3/4"**  
 Overall Height **31 7/8"**  
 Overall Width **24 7/8"**  
 Overall Depth **22 1/2"**

**Multi-purpose chair (with armrests and writing tablet)**



Seat height **17 3/4"**  
 Overall Height **31 7/8"**  
 Overall Width **26 1/4"**  
 Overall Depth **22 1/2"**

**16 stacked multi-purpose chairs (without armrests)**



Overall Height **83"**  
 Overall Width **21 5/8"**  
 Overall Depth **22 1/2"**

**16 stacked multi-purpose chairs (with armrests)**



Overall Height **83"**  
 Overall Width **24 7/8"**  
 Overall Depth **22 1/2"**

**190** Inline connector extendable for linking chairs with/with armrest and with/without armrest

**191** Inline connector permanent for linking chairs without/without armrest

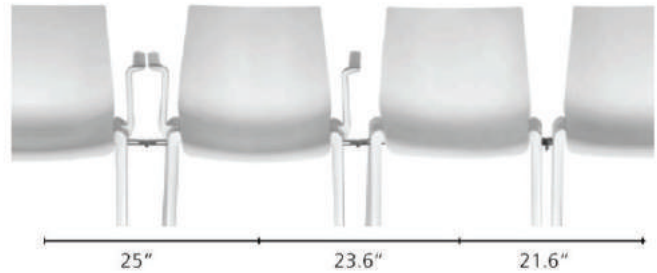

Row widths and distances differ depending on whether Aula is used with or without armrests. Adjustable inline connectors allow linkage of both chairs with armrests and chairs alternately with and without armrests. Non-adjustable inline connectors are available when only chairs without armrests are used.



To number seats and rows, a practical magnetic clip with space to insert the numbers is slotted onto the frame. The fold-up writing tablet can be attached to and locked into place on the armrest in no time without compromising the chair's stacking capabilities.



**Aula**  
**Multi-purpose chairs**

Upholstery material

**Features**

Stackable 16-high free-standing  
Stackable 10-high in trolley

USD	COM USD	COL USD	Racer grade 3 USD	Fabric grade 4 USD	Fabric grade 5 USD	Fabric grade 6 * USD	Fabric grade 9 USD	Leather 74 USD
-----	---------	---------	-------------------	--------------------	--------------------	----------------------	--------------------	----------------

**238/10 Multi-purpose chair without upholstery**



**shell Plastic**  
seat Plastic, back Plastic

455	-	-	-	-	-	-	-	-
-----	---	---	---	---	---	---	---	---

**238/11 Multi-purpose chair with seat cushioning**



**shell Plastic**  
seat Fabric, back Plastic

-	698	860	624	684	711	745	795	810
---	-----	-----	-----	-----	-----	-----	-----	-----

\* Not available in Skai faux leather

**Additional charges specific to range**

**USD**

<b>Armrests:</b>	1. a) Polyamide armrests	121
	b) blue/gray frame	121

**Accessories**

**USD**

186 Four-wheeled trolley for 10 stackable chairs	687
190 In-line connector extendable for linking chairs with/with armrest and with/without armrest	82
191 In-line connector permanent for linking chairs without/without armrest	43
192 Clip for seat and row numbering can be slotted onto the right or the left, magnetic	22
193 Seat number tags (set of 1-50)	362
194 Row number tags (set of 1-30)	217
196 Number tag board for 50 tags, magnetic	67
197 Fold-up writing tablet can be slotted on, only available for chairs with armrests, stackable	239
198 Binder for number tag boards	43

**COM/COL Requirements (238/11)**

**COM (yd)**

**COL (sq.ft.)**

Seat only	1	5
-----------	---	---

COM yardage and COL square footage requirements may differ from standard requirements due to leather types and/or fabric patterns. The ultimate yardage/square footage will be determined at time of testing. Please refer to Terms and Conditions for COM/COL terms.

**Aula**  
**Multi-purpose chairs**

Upholstery material

**Features**

Stackable 16-high free-standing  
Stackable 10-high in trolley

USD	COM USD	COL USD	Racer grade 3 USD	Fabric grade 4 USD	Fabric grade 5 USD	Fabric grade 6 * USD	Fabric grade 9 USD	Leather 74 USD
-----	------------	------------	----------------------	-----------------------	-----------------------	-------------------------	-----------------------	-------------------

**238/12 Multi-purpose chair with seat and back cushioning**



**shell Plastic**

seat Fabric, back Fabric

-	987	1149	817	962	1012	1058	1128	1099
---	-----	------	-----	-----	------	------	------	------

**238/13 Multi-purpose chair fully upholstered (front and back)**



**shell Plastic**

seat Fabric, back Fabric

-	1320	1482	-	1295	1345	1391	1461	1432
---	------	------	---	------	------	------	------	------

\* Not available in Skai faux leather

**Additional charges specific to range**

	USD
<b>Armrests:</b> 1. a) Polyamide armrests	121
b) blue/gray frame	121

**Accessories**

	USD
186 Four-wheeled trolley for 10 stackable chairs	687
190 In-line connector extendable for linking chairs with/with armrest and with/without armrest	82
191 In-line connector permanent for linking chairs without/without armrest	43
192 Clip for seat and row numbering can be slotted onto the right or the left, magnetic	22
193 Seat number tags (set of 1-50)	362
194 Row number tags (set of 1-30)	217
195 Magnetic clip for number tags	67
197 Fold-up writing tablet can be slotted on, only available for chairs with armrests, stackable	239
198 Binder for number tag boards	43

**COM/COL Requirements (238/12 & 238/13)**

	COM (yd)	COL (sq.ft.)
Seat and back (238/12)	1	10.5
Fully upholstered (238/13)	1.5	19

COM yardage and COL square footage requirements may differ from standard requirements due to leather types and/or fabric patterns. The ultimate yardage/square footage will be determined at time of testing. Please refer to Terms and Conditions for COM/COL terms.

All chairs are fitted with multipurpose glides for soft and hard floorings, in the case of sensitive floorings please order with extra felt glides (at no additional charge).

## 249 range

### Cura

Design: wiege



#### Technical Details

##### Function

With a lightweight appeal, these classically elegant lounge chairs and low tables are designed to furnish lounges, lobbies, informal meeting spaces or homes.

##### Chair

##### Frame

##### Model 249 / 5

Resilient, bright chromium-plated steel tube, diameter 1", thickness 1/8" attached to flat steel supporting frame, width 1", thickness 3/8". Four glides in black-gray polyamide are standard (for soft floors); optionally in black-gray polyurethane (for hard floors), on request with additional felt insert.

##### Model 249 / 7

Die-cast aluminum, high-lustre polished, four-star base with rigid column and steel, bright chromium-plated seat bearer. Black multi-purpose plastic glides for all types of flooring.

##### Upholstery

Steel frame in square tube with tension springs embedded in polyurethane foam. Exchangeable, one-piece cover with side facings in high-quality woollen fabric or leather.

##### Armrests (only model 249 / 5)

Armrests with contacts in plywood with fully upholstered pads to match the seat or with walnut face veneer, stained and protected with open-pore lacquer.

##### Stool

##### Frame

Die-cast aluminum, high-luster polished, star base with rigid column and steel, bright chrome-plated seat bearer. Black, multi-purpose plastic glides for all types of flooring.

##### Seat

Shaped plywood shell with seating cushion, fully covered.

##### Standards



##### Fabric Grades

Grade 6 = 60 Blend

63 Auris

66 Lona

Grade 9 = 91 Steelcut Trio 3

Leather = 74

Leather = 87

##### GREENGUARD™

Virtually all Wilkhahn products undergo testing and certification in accordance with GREENGUARD. The Greenguard Environmental Institute is an independent institution in the US that certifies products with regard to their suitability for interiors. Besides environmental aspects, special focus is on ensuring that products do not emit any pollutants that might be harmful to health.



Cantilever chair

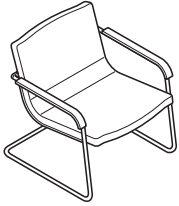

Seat height **13 3/4"**  
Overall Height **29 1/2"**  
Overall Width **27 1/2"**  
Overall Depth **28"**

Low table

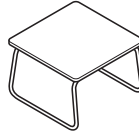

Overall Height **14 1/8"**  
Overall Width **21 1/4"**  
Overall Depth **21 1/4"**

Chair



Seat height **13 3/4"**  
Overall Height **29 1/2"**  
Overall Width **23 1/4"**  
Overall Depth **28"**

Low table

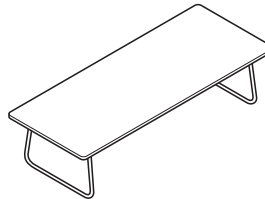



Overall Height **14 1/8"**  
Overall Width **59"**  
Overall Depth **23 5/8"**

Stool

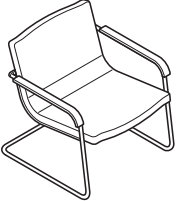

Overall Height **16 1/8"**  
Overall Width **23 5/8"**  
Overall Depth **19 5/8"**

Upholstery material

		Fabric grade 6 *	Fabric grade 9	Leather 74	Leather 87
		USD	USD	USD	USD
<b>249/5 Cantilever chair</b>					
	<b>frame Bright Chrome Aluminum</b> seat Upholstered, back Upholstered	2323	2489	2804	3269
	<b>Additional charges to the chair model</b> armrests fully upholstered to match seat covers	137	137	265	332
<b>249/7 Chair</b>					
	<b>frame High-Luster Polished Aluminum</b> seat Upholstered, back Upholstered	1943	2109	2424	2889
<b>249/8 Stool</b>					
	<b>frame High-Luster Polished Aluminum</b> seat Upholstered, back Upholstered	1149	1218	1381	1602

\* Not available in Skai faux leather

Table top group

Laminate	Veneer variation 1	Veneer variation 2
<b>USD</b>	<b>USD</b>	<b>USD</b>

249/1 Low table

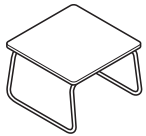

frame Bright Chrome Aluminum

1149 1734 1801

249/3 Low table

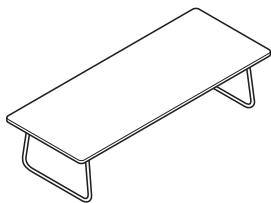

frame Bright Chrome Aluminum

1448 2112 2278



Cura chairs and Aline low table



Cura chair and stool and Cura low table



Cura chair and stool

## Modus range

Design: Klaus Franck, Werner Sauer and wiege, Fritz Frenkler, Justus Kolberg



### Technical Details

#### Function

Task chairs with backrest frame and automatic synchro-adjustment: the seat/backrest angle adjusts automatically to the sitting position of the user. When leaning back, the backrest tension increases according to the need for additional support. Infinitely variable tension adjustment for the user. Forward position lockable by engaging lever. Gas lift, conforming to DIN 4550, for infinitely variable adjustment of seat height.

Task conference/visitor chairs with automatic synchro-adjustment, without front locking position, with fixed seat height.

#### Frame

##### Task chairs, conference and visitor chairs

##### Modus Compact, Medium

Die-cast aluminum star base, powder coated, polished or bright chrome-plated. Twin wheel swivel castors in black polyamide with load-dependent braking, conforming to DIN EN 12529, as the standard version for carpeted floors, or with a gray polyurethane soft lining for hard floors. Anti-static castors on request. Glides in black polyamide as the standard version for carpeted floors, or in black polyurethane for hard floors. Die-cast aluminum swing plates, powder coated to match the star base, polished or bright chrome-plated. Synchro-mechanism case in sheet steel, coated black.

##### Modus Executive

Die-cast aluminum 5-star base, powder coated, polished or bright chrome-plated.

Conference/visitor chairs with four-star base in die-cast aluminum, powder coated, polished or bright chrome-plated. Twin wheel swivel castors in black polyamide with load-dependent braking, conforming to DIN EN 12529, as the standard version for carpeted floors, or with a gray polyurethane soft lining for hard floors. Anti-static castors on request.

Glides in black polyamide as the standard version for carpeted floors, or in black polyurethane for hard floors. Die-cast aluminum swing plates, polished or bright chrome-plated to match the star base.

#### Cantilever chairs

##### Modus Compact

Steel tube frame, bright chrome-plated, matte chrome-plated or powder coated, with anti-tilt stoppers as the standard version for carpeted floors: with additional glides for hard floors, optionally with additional felt insert. The stackable version is available with a bright chrome-plated frame only.

##### Modus Medium, Executive

Steel tube frame, bright chrome-plated, matte chrome-plated or powder coated, with anti-tilt stoppers as the standard version for carpeted floors: with additional glides for hard floors, optionally with additional felt insert.

#### Seat

##### Modus Compact, Medium

Seat shell in black, viscoelastic polypropylene. Seat upholstery: one-piece molded polyurethane foam with exchangeable cover. Side facing: black polyamide for fabric cover and embossed leather in the same color for leather cover.

##### Modus Executive

Seat shell in black, viscoelastic polypropylene. Seat upholstery: one-piece molded polyurethane foam with exchangeable cover. Side facing in embossed leather in the same color for leather cover.

## Backrest

### Task, conference and visitor chairs

#### Modus Compact

Frame in black, reinforced fiberglass polyamide. Exchangeable frame covering in black polyamide fabric, non-transparent or semi transparent. Non-transparent material optionally covered on the front and with cut foam underlay. Standard and medium-height backrest with a crescent shaped grip covered in black embossed leather for fabric cover; in the same color leather for leather cover. High backrest with a shoulder support with a forward curvature, covered in embossed leather for fabric cover; in the same color leather for leather cover. Backrests of swivel chairs 273, 274 and 275 optionally with integral, adjustable lumbar support (not possible for version with semi transparent material).

#### Modus Medium

Frame in black, glass fibre-reinforced polyamide. Exchangeable frame covering in black polyamide material, non-transparent or semi transparent, non-transparent version with underpadding. Non-transparent material optionally additionally covered on the front and with cut foam underlay. Standard backrest with a crescent shaped grip covered in black embossed leather for fabric cover; in the same color leather for leather cover. High backrest with a shoulder support with a forward curvature, covered in embossed leather for fabric cover; in the same color leather for leather cover. Swivel chairs optionally available with height-adjustable lumbar support.

#### Modus Executive

Frame in black, glass-reinforced fiberglass polyamide. Exchangeable frame covering in black polyamide material, with slim leather-covered cushion on seat and backrest.

On request, outer side of backrest frame with cover. Standard height backrest with a straight edge. High backrest with shoulder support with a forward curvature, with slim, leather-covered cushion.

#### Cantilever chairs

##### Modus Compact

Frame in steel tube, bright chrome-plated, matte chrome-plated or powder coated. Exchangeable frame covering in black polyamide fabric, non-transparent or semi transparent. Non-transparent material optionally covered on the front and with cut foam underlay. Cantilever chairs 277/7 and 279/7 with a crescent shaped grip in black polypropylene; version with semi transparent material with a crescent shaped grip covered in black embossed leather for fabric or leather cover. Covered backrest with crescent shaped grip in black embossed leather for fabric cover; in the same color leather for leather cover.

##### Modus Medium

Steel tube frame, bright chrome-plated, matte chrome-plated or color coated. Exchangeable frame covering in black polyamide material, non-transparent or semi-transparent. Non-transparent material optionally covered on the front and with cut foam underlay. Crescent shaped grip covered in black embossed leather for fabric cover; in the same color leather for leather cover.

##### Modus Executive

Steel tube frame, bright chrome-plated or matte chrome-plated to match frame. Exchangeable frame covering in black polyamide material, with slim leather-covered cushion on seat and backrest. On request, outer side of backrest frame with leather cover. Backrest with a straight edge.

#### Armrests

### Swivel, conference and visitor chairs

#### Modus Compact

Armrests in black, reinforced fiberglass polyamide. Optionally with height adjustable armrests in the same material.

#### Modus Medium

Armrests in black, textured, reinforced fiberglass polyamide. On request, with black, embossed leather pad for fabric cover; in the same color leather for leather cover. On request, with armrests in die-cast aluminum, aluminum polished or bright chrome-plated with black leather pad for fabric cover; in the same color leather for leather cover.

#### Modus Executive

Armrests in black, textured, reinforced fiberglass polyamide, with additional embossed leather pad in the same color leather. Optionally, with armrests in die-cast aluminum, aluminum polished or bright chrome-plated with leather pad and triple-sewn seam in the same color leather.

For Conference /visitor chairs, armrests in die-cast aluminum, aluminum polished or bright chrome-plated, with leather pad and triple-sewn seam in the same color leather.

#### Four-legged chairs

##### Modus Compact

Armrests in black, reinforced fiberglass polypropylene.

##### Cantilever chairs

##### Modus Compact

Armrest pads in black polypropylene or laminated beech, natural finish.

##### Modus Medium

Armrest pads in laminated beech, natural finish, optionally in polypropylene with black, embossed leather pad for fabric cover; in the same color leather for leather cover.

##### Modus Executive

Armrest pads covered in the same color leather.

## Standards

Modus chairs conform to the Office Chair Standard DIN EN 1335, ANSI/BIFMA X 5.1, BS 5459 and other international office chair standards. They meet the requirements of category B of the Office Chair Standard DIN EN 1335.

Modus four-legged visitor chairs conform to DIN 68878 – 1 and ANSI/BIFMA X 5.1.



#### Fabric Grades

**Grade 5 = 54** Pitch  
**Grade 6 = 60** Blend  
**62** Bond  
**63** Auris  
**66** Lona  
**68** Remix 2  
**69** Granit  
**Grade 9 = 91** Steelcut Trio 3

#### Skai Faux Leather

**Leather = 74**  
**Leather = 87**

#### GREENGUARD™

Virtually all Wilkhahn products undergo testing and certification in accordance with GREENGUARD. The Greenguard Environmental Institute is an independent institution in the US that certifies products with regard to their suitability for interiors. Besides environmental aspects, special focus is on ensuring that products do not emit any pollutants that might be harmful to health.



**Modus Compact  
Task chair Medium-height backrest**



Seat Height **16 1/2" - 20 7/8"**  
Overall Height **38 5/8" - 42 7/8"**  
Overall Width **25 1/4"**  
Overall Depth **24"**

**Modus Medium  
Task chair Standard height backrest**



Seat Height **16 1/2" - 20 7/8"**  
Overall Height **34 7/8" - 40 1/8"**  
Overall Width **26 3/4"**  
Overall Depth **24 3/4"**

**Modus Compact  
Task chair High backrest**



Seat Height **16 1/2" - 28 7/8"**  
Overall Height **41 3/4" - 46 1/8"**  
Overall Width **25 1/4"**  
Overall Depth **24"**

**Modus Medium  
Task chair High backrest**



Seat Height **16 1/2" - 20 7/8"**  
Overall Height **44 1/8" - 48 3/8"**  
Overall Width **26 3/4"**  
Overall Depth **24 3/4"**

**Modus Compact  
Cantilever chair Standard height backrest**

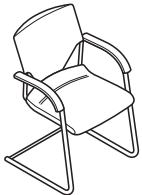

Seat Height **16 7/8"**  
Overall Height **33 1/2"**  
Overall Width **22 1/2"**  
Overall Depth **22"**

**Modus  
Dimensions**

---

**Modus Executive  
Task chair Standard height backrest**



Seat Height	<b>16 1/2" - 20 7/8"</b>
Overall Height	<b>35 7/8" - 40 1/8"</b>
Overall Width	<b>26 3/4"</b>
Overall Depth	<b>25 5/8"</b>

**Modus Executive  
Task chair High backrest**



Seat Height	<b>16 1/2" - 20 7/8"</b>
Overall Height	<b>44 1/8" - 48 3/8"</b>
Overall Width	<b>26 3/4"</b>
Overall Depth	<b>25 5/8"</b>

**Modus Executive  
Cantilever chair Standard height backrest**

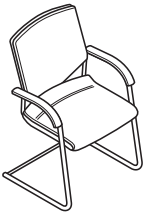

Seat Height	<b>16 7/8"</b>
Overall Height	<b>35 7/8"</b>
Overall Width	<b>25 5/8"</b>
Overall Depth	<b>24"</b>

## 27 range

### Modus Compact

Design: Klaus Franck, Werner Sauer and  
wiege, Fritz Frenkler, Justus Kolberg



## Modus Compact Task chairs

Wilkhahn

Upholstery material

### Features

Seat cushion  
Pneumatic height adjustment  
Automatic synchro-adjustment, tension control

COM	COL	Fabric grade 5	Fabric grade 6 / Skai faux leather	Fabric grade 9	Leather 74
USD	USD	USD	USD	USD	USD

### 275/7 Medium-height backrest



#### base Matte Polished Aluminum

seat Upholstered, inner and outer back Non-Transparent Mesh	2887	3572	2849	2925	3036	3522
seat and inner back Upholstered, outer back Non-Transparent Mesh	3081	4176	3024	3138	3304	4126
seat, inner and outer back Upholstered (outer back not available for faux leather)	3275	4738	3199	3351	3572	4688

#### base Bright Chrome Aluminum

seat Upholstered, inner and outer back Non-Transparent Mesh	3062	3747	3024	3100	3211	3697
seat and inner back Upholstered, outer back Non-Transparent Mesh	3256	4351	3199	3313	3479	4301
seat, inner and outer back Upholstered (outer back not available for faux leather)	3450	4913	3374	3526	3747	4863

<sup>1</sup> Powder Coat colors: Silver or Black

Note: pricing for upholstered seat and back is based on the same upholstery material (e.g. seat, inner and outer back upholstered in Fabric Grade 5).

Additional charges/reduced prices specific to range		USD
<b>Frame:</b>	1. a) base Powder Coated <sup>1</sup>	-102
<b>Armrests:</b>	1. a) height-adjustable armrests; or b) without armrests	246 -204
<b>Other:</b>	1. a) semi transparent backrest material 2. a) anti-static castors	No additional cost 95

COM/COL Requirements (275/7)	COM (yd)	COL (sq.ft.)
Seat only	1	7
Seat and inner back	1	12
Seat, inner and outer back	2	16

COM yardage and COL square footage requirements may differ from standard requirements due to leather types and/or fabric patterns. The ultimate yardage/square footage will be determined at time of testing. Please refer to Terms and Conditions for COM/COL terms.

All swivel chairs are fitted with hard castors for soft floors (e.g. carpet). For hard floors (e.g. stone, wood), please specify soft castors when ordering (no additional charge). Additional charge for anti-static castors. Semi-transparent backrest not available in combination with back cushion and/or lumbar support.

## Modus Compact Task/visitor chairs

# Wilkhahn

Upholstery material

### Features

Seat cushion  
Pneumatic height adjustment  
Automatic synchro-adjustment, tension control

COM	COL	Fabric grade 5	Fabric grade 6 / Skai faux leather	Fabric grade 9	Leather 74
USD	USD	USD	USD	USD	USD

### 274/7 High backrest



#### base Matte Polished Aluminum

seat Upholstered, inner and outer back Non-Transparent Mesh	3401	4086	3363	3439	3550	4036
seat and inner back Upholstered, outer back Non-Transparent Mesh	3595	4690	3538	3652	3747	4640
seat, inner and outer back Upholstered (outer back not available for faux leather)	3789	5252	3713	3865	4015	5202

#### base Bright Chrome Aluminum

seat Upholstered, inner and outer back Non-Transparent Mesh	3576	4261	3538	3614	3725	4211
seat and inner back Upholstered, outer back Non-Transparent Mesh	3770	4865	3713	3827	3922	4815
seat, inner and outer back Upholstered (outer back not available for faux leather)	3964	5427	3888	4040	4190	5377

<sup>1</sup> Powder Coat colors: Silver or Black

Note: pricing for upholstered seat and back is based on the same upholstery material (e.g. seat, inner and outer back upholstered in Fabric Grade 5).

### Additional charges/reduced prices specific to range USD

<b>Frame:</b>	1. a) base Powder Coated <sup>1</sup>	-102
<b>Armrests:</b>	1. a) height-adjustable armrests; or b) without armrests	246 -204
<b>Other:</b>	1. a) semi-transparent backrest material 2. a) anti-static castors	No additional cost 95

### COM/COL Requirements (274/7) COM (yd) COL (sq.ft.)

Seat only	1	7
Seat and inner back	1	14
Seat, inner and outer back	1.5	18

COM yardage and COL square footage requirements may differ from standard requirements due to leather types and/or fabric patterns. The ultimate yardage/square footage will be determined at time of testing. Please refer to Terms and Conditions for COM/COL terms.

## Modus Compact Cantilever chairs

Wilkhahn

Upholstery material

### Features

Stackable version stacks 5-high free-standing

COM	COL	Fabric grade 5	Fabric grade 6 / Skai faux leather	Fabric grade 9	Leather 74
USD	USD	USD	USD	USD	USD

### 277/7 Standard height backrest

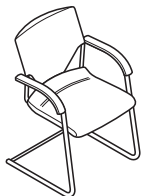

#### frame Bright Chrome Aluminum

seat Upholstered, inner and outer back Non-Transparent Mesh	1839	2524	1801	1877	1988	2474
seat and inner back Upholstered, outer back Non-Transparent Mesh	1961	3024	1905	2017	2185	2974
seat, inner and outer back Upholstered (outer back not available for faux leather)	2155	3586	2080	2230	2453	3536

Note: pricing for upholstered seat and back is based on the same upholstery material  
(e.g. seat, inner and outer back upholstered in Fabric Grade 5).

### Additional charges specific to range

USD

<b>Armrests:</b>	1. a) armrests with Embossed Leather Pad (cannot be offered on stackable version); or	396
	b) armrests in Laminated Beech	218
<b>Other:</b>	1. a) semi-transparent backrest material	No additional cost

### Accessories

USD

277 Four-wheeled cart for 6 cantilever chairs	1306
---	------

### COM/COL Requirements (277/7)

COM (yd)

COL (sq.ft.)

Seat only	1	7
Seat and inner back	1	11
Seat, inner and outer back	1.5	15

COM yardage and COL square footage requirements may differ from standard requirements due to leather types and/or fabric patterns. The ultimate yardage/square footage will be determined at time of testing. Please refer to Terms and Conditions for COM/COL terms.

All conference and visitor chairs as well as cantilever chairs are fitted with hard glides for soft floors (e.g. carpet). For hard floors with additional felt insert (e.g. wood and tile), with no additional charge.

108

## 28 range

### Modus Medium

Design: Klaus Franck, Werner Sauer and  
wiege, Fritz Frenkler, Justus Kolberg



**Modus Medium**  
**Task chairs**

Upholstery material

**Features**

- Seat cushion
- Pneumatic height adjustment
- Automatic synchro-adjustment, tension control

COM	COL	Fabric grade5	Fabric grade 6 / Skai faux leather	Fabric grade 9	Leather 74
USD	USD	USD	USD	USD	USD

**283/7 Standard height backrest**



**base Matte Polished Aluminum**

seat Upholstered, inner and outer back Non-Transparent Mesh	3152	3749	3123	3181	3268	3699
seat and inner back Upholstered, outer back Non-Transparent Mesh	3518	4672	3472	3564	3702	4622
seat, inner and outer back Upholstered (outer back not available for faux leather)	3669	5108	3609	3728	3907	5058

**base Bright Chrome Aluminum**

seat Upholstered, inner and outer back Non-Transparent Mesh	3292	3889	3263	3321	3408	3839
seat and inner back Upholstered, outer back Non-Transparent Mesh	3658	4812	3612	3704	3842	4762
seat, inner and outer back Upholstered (outer back not available for faux leather)	3809	5248	3749	3868	4047	5198

**284/7 High backrest**

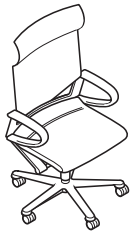

**base Matte Polished Aluminum**

seat Upholstered, inner and outer back Non-Transparent Mesh	3753	4350	3724	3782	3869	4300
seat and inner back Upholstered, outer back Non-Transparent Mesh	4172	5550	4131	4213	4337	5500
seat, inner and outer back Upholstered (outer back not available for faux leather)	4323	5986	4268	4377	4542	5936

**base Bright Chrome Aluminum**

seat Upholstered, inner and outer back Non-Transparent Mesh	3893	4490	3864	3922	4009	4440
seat and inner back Upholstered, outer back Non-Transparent Mesh	4312	5690	4271	4353	4477	5640
seat, inner and outer back Upholstered (outer back not available for faux leather)	4463	6126	4408	4517	4682	6076

<sup>1</sup> Powder Coat colors: Silver or Black

Note: pricing for upholstered seat and back is based on the same upholstery material (e.g. seat, inner and outer back upholstered in Fabric Grade 5).

**Additional charges/reduced prices specific to range**

		USD
<b>Frame:</b>	1. a) base Powder Coated <sup>1</sup>	-82
<b>Armrests:</b>	1. a) armrests with Embossed Leather Pad; or	357
	b) armrests Matte Polished with Leather Pad (in combination with Matte Polished frame); or	472
	c) armrests Bright Chrome with Leather Pad (in combination with Bright Chrome frame)	627
<b>Other:</b>	1. a) semi-transparent backrest material	No additional cost
	2. a) lumbar support (not in combination with semi transparent backrest material)	137
	3. a) anti-static castors	95

**COM/COL Requirements (283/7 & 284/7)**

	COM (yd)	COL (sq.ft.)
Seat only	1	8
Seat and inner back (283/7 model)	1	13
Seat, inner and outer back (283/7 model)	1.5	18
Seat and inner back (284/7 model)	1	17
Seat, inner and outer back (284/7 model)	1.5	22

COM yardage and COL square footage requirements may differ from standard requirements due to leather types and/or fabric patterns. The ultimate yardage/square footage will be determined at time of testing. Please refer to Terms and Conditions for COM/COL terms.

## 28 range

### Modus Executive

Design: Klaus Franck, Werner Sauer and  
wiege, Fritz Frenkler, Justus Kolberg



**Modus Executive  
Task chairs**

Upholstery material

**Features**

Seat and backrest with slim, leather-covered cushion  
Pneumatic height adjustment  
Automatic synchro-adjustment, tension control

COL	Leather 74	Leather 87
USD	USD	USD

**283/81 Standard height backrest**



**base Matte Polished Aluminum**

seat Leather, back Leather

6651 6601 6996

**base Bright Chrome Aluminum**

seat Leather, back Leather

6825 6775 7170

**Additional charges to the chair model**

backrest Upholstered on outer back

595 545 696

**284/81 High backrest**



**base Matte Polished Aluminum**

seat Leather, back Leather

8271 8221 8720

**base Bright Chrome Aluminum**

seat Leather, back Leather

8445 8395 8894

**Additional charges to the chair model**

backrest Upholstered on outer back

595 545 696

\* Not available in Skai faux leather

**Additional charges specific to range**

**USD**

<b>Armrests:</b>	1. a) armrests Matte Polished with Leather Pad (in combination with Matte Polished frame); or	145
	b) armrests Bright Chrome with Leather Pad (in combination with Bright Chrome frame)	362
<b>Other:</b>	1. a) anti-static castors	95

**COM/COL Requirements (283/81 & 284/1)**

**COM (yd)**

**COL (sq.ft.)**

Seat and inner back (283/81 model)	N/A	16
Seat, inner and outer back (283/81 model)	N/A	21
Seat and inner back (284/81 model)	N/A	20
Seat, inner and outer back (284/81 model)	N/A	25

COM yardage and COL square footage requirements may differ from standard requirements due to leather types and/or fabric patterns. The ultimate yardage/square footage will be determined at time of testing. Please refer to Terms and Conditions for COM/COL terms.

**Modus Executive  
Cantilever chairs**

**Wilkhahn**

Upholstery material

**Features**

Seat and backrest with slim, leather-covered cushion

COL	Leather 74	Leather 87
<b>USD</b>	<b>USD</b>	<b>USD</b>

**287/81 Standard height backrest**

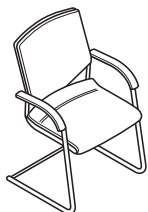

**base Bright Chrome Aluminum**

seat Leather, back Leather

5270 5220 5615

**Additional charges to the chair model**

backrest Upholstered on outer back

595 545 696

**COM/COL Requirements (287/81)**

**COM (yd)      COL (sq.ft.)**

Seat and inner back

N/A      17

Seat, inner and outer back

N/A      23

*COM yardage and COL square footage requirements may differ from standard requirements due to leather types and/or fabric patterns. The ultimate yardage/square footage will be determined at time of testing. Please refer to Terms and Conditions for COM/COL terms.*



Modus chairs and Conversa tables



Modus chairs and Confair tables

## 295 range

### Intra

Design: Phoenix Design



#### Technical Details

##### Function

Conference, lounge and executive chair range in a contemporary design with integrated synchronous adjustment mechanism that automatically adapts to the weights of people sitting on it.

##### Frame

Five-star base in die-cast aluminium, bright chrome-plated, matte polished and coated in black or white with a textured matte finish. Round plastic multipurpose glides, color matched with the frame, for all types of flooring: bright chrome-plated when the frame is bright chrome-plated, matte polished or coated in white with a textured matte finish, in black when the frame is coated in black with a textured matte finish.

For wooden floorings (e.g. parquet) please order with extra felt insert. Version on glides optionally available with swivel-return mechanism and without height adjustment (seating height 45 cm).

Optionally with castors. Twin wheel swivel castors with load-dependent braking, made of black polyamide compliant with DIN EN 12529 as the standard version for carpets; with gray soft polyurethane facing for hard floors. The gas lift is covered with a protective tube color matched with the frame, bright chrome-plated, matte polished or textured matte finish coated black or white. Precision adjustable seating height via a gas lift.

##### Back

Backrest shell made of plywood, fully padded with polyurethane (CFC-free) with additional padding. Curved flat steel backrest bearer to connect with the synchronous adjustment mechanism.

##### Seat

Seat shell made of fibreglass reinforced polypropylene covered with fabric or leather, with polypropylene seat upholstery panel, seat cushioning made of polyurethane with padding in the same material as the cover with side facings. The cushioning and covers are replaceable. The synchronous adjustment mechanism with automatic weight adjustment is located between the seat shell and upholstery element.

##### Standards

\*Tests being conducted for the GS mark.

##### Armrest

Die-cast aluminium armrests, bright chrome-plated, matte polished or coated in black or white with a textured matte finish depending on the type of frame, optionally with integrated, leather-covered armrest pad. The armrest pads come in black 74/99 leather for fabric-covered models and are the same color as the leather in leather-covered models. The controls for adjusting the height and locking it in place are integrated in the armrests.

Fabric Grades

**Grade 6 = 60** Blend  
**62** Bond  
**63** Auris  
**66** Lona  
**69** Granit

**Grade 9 = 91** Steelcut Trio 3

**Leather = 74**  
**Leather = 87**



295/6 Standard height backrest



Seat height **15 1/2"-20 1/2"**  
Overall Height **34"- 38"**  
Overall Width **25 1/2"**  
Overall Depth **27"**

295/7 Medium height backrest



Seat height **15 1/2"- 20 1/2"**  
Overall Height **40 1/2" - 45"**  
Overall Width **25 1/2"**  
Overall Depth **27"**

**295 Intra  
Conference chairs**

Upholstery material

**Features**

Fully upholstered backrest, seat cushioning & armrest  
Precision adjustable seating height via gas lift.  
Automatic synchro-adjustment, tension control  
Weight adjustment

COM	COL	Fabric grade 6*	Fabric grade 9	Leather 74	Leather 87
USD	USD	USD	USD	USD	USD

**295/6 Standard-height backrest**



**base Powder Coated Aluminum /arms in Coated Aluminum**

seat Upholstered, back Upholstered

3856 4738 3712 3999 4688 5628

**base Matte Polished Aluminum /arms in Polished Aluminum**

seat Upholstered, back Upholstered

4015 4897 3871 4158 4847 5787

**base Bright Chrome Aluminum / arms in Bright Chrome**

seat Upholstered, back Upholstered

4784 5666 4640 4927 5616 6556

\* Not available in Fabric 68 Remix

**295/7 Medium-height backrest**



**base Powder Coated Aluminum /arms in Coated Aluminum**

seat Upholstered, back Upholstered

4354 4974 4191 4516 4924 6109

**base Matte Polished Aluminum / arms in Polished Aluminum**

seat Upholstered, back Upholstered

4513 5133 4350 4675 5083 6268

**base Bright Chrome Aluminum / arms in Bright Chrome**

seat Upholstered, back Upholstered

5282 5892 5119 5444 5842 7037

\* Not available in Fabric 68 Remix

**Additional charges/reduced prices specific to range**

**USD**

<b>Frame:</b>	1. a) Swivel-return mechanism (only for non height adjustable models)	255
	b) 5-star base on glides (in lieu of 5-star base on castors)	-133
<b>Other:</b>	1. a) Leather- covered armrest pad	337

**COM/COL Requirements (295)**

**COM (yd)**

**COL (sq.ft.)**

\* Information pending. For exact yardage, please contact your local Wilkhahn representative.



Intra Medium-back Conference chair

## 30 range Graph

Design: Jehs + Laub



### Technical Details

#### Function

Formal and distinctive, high-end conference chair in two backrest heights. Armrests stylishly link the seat and backrest. Extreme, sprung (and at the sides also elastic) seating comfort due to three-point support with rear spring strut and sophisticated upholstery. Areas used: traditional conference and meeting rooms, executive offices and boards, high-quality restaurants or prestigious dining areas.

#### Frame

Four-star base in die-cast aluminum, powder coated black or white, polished or bright chrome-plated. Optionally with base glides with larger contact area for sensitive floorings, either to match the star base black or white coated, matte chrome-plated (polished star base) or bright chrome-plated (bright chrome-plated star base). Black polyamide glides for carpets. For hard floors (e. g. stone), please order with soft TPU, for wooden floors (e. g. parquet) with additional felt. These glides change the seating height to 17.32". Optionally with castors for 4-star bases in line with DIN EN 1335 and ANSI BIFMA X 5.1 for conference chairs. Load-dependent braking, twin wheel swivel castors made of black polyamide in line with DIN EN 12529, with black polyurethane coating for both hard and soft floors. Models 301/8, 302/8: Swivel mounted column with seat bearer and integrated rocking mechanism made of die-cast aluminum and high-luster polished or matte polished.

Castors with black plastic shell, either with chrome-plated ring (coated star base), matte chrome-plated ring (star base polished) or chrome-plated ring (star base bright chrome-plated). These glides change the seating height to 17.7".

Columns can be swivelled with die-cast aluminum Y-shaped seat bearer, polished or bright chrome-plated to match the star base, either black or white coated.

Permanently elastic, rubber/metal connecting elements. Spring elastic struts made of top-quality spring steel in black.

#### Seat and back

Seat and back frame made of metal, with wave springs, additional cushioning and fully padded with polyurethane.

#### Armrests

Armrests that connect the seat and back made of die-cast aluminum and to match the frame black or white powder coated, polished or bright chrome-plated. Optional leather arms.



#### Fabric Grades

**Grade 6 = 60** Blend  
**62** Bond  
**63** Auris  
**66** Lona  
**68** Remix 2  
**Grade 9 = 91** Steelcut Trio 3

**Skai Faux Leather**  
**Leather = 74**  
**Leather = 87**

Medium-height backrest



Seat height **16 7/8"**  
Overall Height **40 1/8"**  
Overall Width **24 3/8"**  
Overall Depth **25 1/4"**

Medium-height backrest, height adjustable

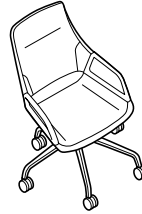

Seat height **16 1/8"-20"**  
Overall Height **39 3/8"-48 1/2"**  
Overall Width **24 3/8"**  
Overall Depth **25 1/4"**

High backrest



Seat height **16 7/8"**  
Overall Height **49 1/4"**  
Overall Width **24 3/8"**  
Overall Depth **25 1/4"**

High backrest, height adjustable

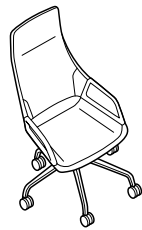

Seat height **16 1/8"-20"**  
Overall Height **48 1/2"-52 3/8"**  
Overall Width **24 3/8"**  
Overall Depth **25 1/4"**

Medium-height backrest on castors



Seat height **19"**  
Overall Height **41"**  
Overall Width **24 3/8"**  
Overall Depth **25 1/4"**

High backrest on castors



Seat height **19"**  
Overall Height **51 1/8"**  
Overall Width **24 3/8"**  
Overall Depth **25 1/4"**

# Graph Conference chair

Upholstery material

## Features

One-piece seat and back frame, fully upholstered

COM	COL	Fabric grade 6 / Skai faux leather	Fabric grade 9	Leather 74	Leather 87
USD	USD	USD	USD	USD	USD

### 301/5 Medium-height backrest



**base Powder Coated Aluminum** <sup>1</sup>

seat Upholstered, back Upholstered

**base Matte Polished Aluminum**

seat Upholstered, back Upholstered

**base Bright Chrome Aluminum**

seat Upholstered, back Upholstered

4697	5480	4598	4795	5430	6155
4929	5712	4830	5027	5662	6387
5718	6501	5619	5816	6451	7176

### 302/5 High backrest

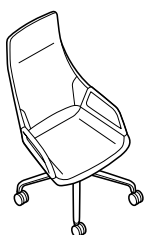

**base Powder Coated Aluminum** <sup>1</sup>

seat Upholstered, back Upholstered

**base Matte Polished Aluminum**

seat Upholstered, back Upholstered

**base Bright Chrome Aluminum**

seat Upholstered, back Upholstered

5531	6559	5409	5653	6509	7367
5763	6791	5641	5885	6741	7599
6552	7580	6430	6674	7530	8388

<sup>1</sup> Powder Coat colors: White or Black

Castor finishes:

- a) black Plastic shell with Chrome ring; or
- b) black Plastic shell with Matte Polished ring

### Additional charges/reduced prices specific to range

USD

#### Frame:

- 1. a) swivel-return mechanism

256



- 2. a) 4-star base on glides (in lieu of 4-star base on castors)

-171

#### Other:

- 1. a) CAL133 compliant charge (applies only to certain models and finishes. Please ensure textiles meet all appropriate flammability requirements)
- b) leather-covered armrest pads

207  
564

### COM/COL Requirements (301/5 & 302/5)

COM (yd)

COL (sq.ft.)

Seat and back (Medium-height backrest)

1.6

32

Seat and back (High backrest)

2

38

COM yardage and COL square footage requirements may differ from standard requirements due to leather types and/or fabric patterns. The ultimate yardage/square footage will be determined at time of testing. Please refer to Terms and Conditions for COM/COL terms.

**Graph**  
**Conference chair - 5 star base (station)**

Upholstery material

**Features**

One-piece seat and back frame, fully upholstered  
 5- star base with castors

COM	COL	Fabric grade 6 / Skai faux leather	Fabric grade 9	Leather 74	Leather 87
USD	USD	USD	USD	USD	USD

**301/6 Medium-height backrest**



**base Powder Coated Aluminum <sup>1</sup>**

seat Upholstered, back Upholstered

**base Matte Polished Aluminum**

seat Upholstered, back Upholstered

**base Bright Chrome Aluminum**

seat Upholstered, back Upholstered

4739	5522	4640	4837	5472	6197
4971	5754	4872	5069	5704	6429
5760	6543	5661	5858	6493	7218

**302/6 High backrest**

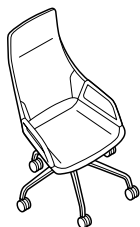

**base Powder Coated Aluminum <sup>1</sup>**

seat Upholstered, back Upholstered

**base Matte Polished Aluminum**

seat Upholstered, back Upholstered

**base Bright Chrome Aluminum**

seat Upholstered, back Upholstered

5573	6601	5451	5695	6551	7409
5805	6833	5683	5927	6783	7641
6594	7622	6472	6716	7572	8430

<sup>1</sup> Powder Coat colors: White or Black

Castor finishes:

- a) black Plastic shell with Chrome ring; or
- b) black Plastic shell with Matte Polished ring

**Additional charges/reduced prices specific to range**

**USD**

**Other:**

- 1. a) CAL133 compliant charge (applies only to certain models and finishes. Please ensure textiles meet all appropriate flammability requirements)
- b) leather-covered armrest pads

207  
564

**COM/COL Requirements (301/6 & 302/6)**

**COM (yd)**

**COL (sq.ft.)**

Seat and back (Medium-height backrest)

1.6

32

Seat and back (High backrest)

2

38

*COM yardage and COL square footage requirements may differ from standard requirements due to leather types and/or fabric patterns. The ultimate yardage/square footage will be determined at time of testing. Please refer to Terms and Conditions for COM/COL terms.*

**Graph**  
**Conference chair - height adjustable**

Upholstery material

**Features**

One-piece seat and back frame, fully upholstered  
 Height-adjustable

COM	COL	Fabric grade 6 / Skai faux leather	Fabric grade 9	Leather 74	Leather 87
USD	USD	USD	USD	USD	USD

**301/7 Medium-height backrest**

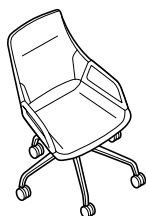

**base Powder Coated Aluminum <sup>1</sup>**

seat Upholstered, back Upholstered

4759 5565 4638 4880 5515 6240

**base Matte Polished Aluminum**

seat Upholstered, back Upholstered

5014 5797 4915 5112 5747 6472

**base Bright Chrome Aluminum**

seat Upholstered, back Upholstered

5803 6586 5704 5901 6536 7261

**302/7 High backrest**

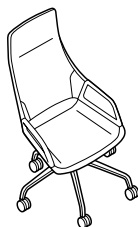

**base Powder Coated Aluminum <sup>1</sup>**

seat Upholstered, back Upholstered

5616 6644 5494 5738 6594 7452

**base Matte Polished Aluminum**

seat Upholstered, back Upholstered

5848 6876 5726 5970 6826 7684

**base Bright Chrome Aluminum**

seat Upholstered, back Upholstered

6637 7665 6515 6759 7615 8473

<sup>1</sup> Powder Coat colors: White or Black

Castor finishes:

- a) black Plastic shell with Chrome ring; or
- b) black Plastic shell with Matte Polished ring

**Additional charges/reduced prices specific to range**

**USD**

**Other:**

- 1. a) CAL133 compliant charge (applies only to certain models and finishes. Please ensure textiles meet all appropriate flammability requirements)
- b) leather-covered armrest pads

207  
564

**COM/COL Requirements (301/5 & 302/5)**

**COM (yd)**

**COL (sq.ft.)**

Seat and back (Medium-height backrest)

1.6

32

Seat and back (High backrest)

2

38

*COM yardage and COL square footage requirements may differ from standard requirements due to leather types and/or fabric patterns. The ultimate yardage/square footage will be determined at time of testing. Please refer to Terms and Conditions for COM/COL terms.*

**Graph**  
**Conference chair - height adjustable with rocking mechanism**

Upholstery material

**Features**

One-piece seat and back frame, fully upholstered  
 Height-adjustable  
 Rocking mechanism

COM	COL	Fabric grade 6 / Skai faux leather	Fabric grade 9	Leather 74	Leather 87
USD	USD	USD	USD	USD	USD

**301/8 Medium-height backrest**

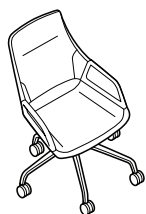

**base Powder Coated Aluminum <sup>1</sup>**

seat Upholstered, back Upholstered

5235 6018 5136 5333 5968 6693

**base Matte Polished Aluminum**

seat Upholstered, back Upholstered

5467 6250 5368 5565 6200 6925

**base Bright Chrome Aluminum**

seat Upholstered, back Upholstered

6256 7039 6157 6354 6989 7714

**302/8 High backrest**

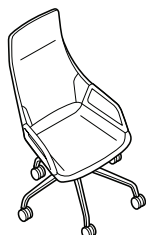

**base Powder Coated Aluminum <sup>1</sup>**

seat Upholstered, back Upholstered

6068 7096 5946 6190 7046 7904

**base Matte Polished Aluminum**

seat Upholstered, back Upholstered

6300 7328 6178 6422 7278 8136

**base Bright Chrome Aluminum**

seat Upholstered, back Upholstered

7089 8117 6967 7211 8067 8925

<sup>1</sup> Powder Coat colors: White or Black

Castor finishes:

- a) black Plastic shell with Chrome ring; or
- b) black Plastic shell with Matte Polished ring

**Additional charges/reduced prices specific to range**

**USD**

Other:		USD
1. a) CAL133 compliant charge (applies only to certain models and finishes. Please ensure textiles meet all appropriate flammability requirements)		207
b) leather-covered armrest pads		564

**COM/COL Requirements (301/8 & 302/8)**

**COM (yd)**

**COL (sq.ft.)**

Seat and back (Medium-height backrest)	1.6	32
Seat and back (High backrest)	2	38

*COM yardage and COL square footage requirements may differ from standard requirements due to leather types and/or fabric patterns. The ultimate yardage/square footage will be determined at time of testing. Please refer to Terms and Conditions for COM/COL terms.*



Graph chairs and 632 Range table



Graph chairs

## 340 range

### Chassis

Design: Stefan Diez



#### Technical Details

##### Function

Four legged, lightweight multi-purpose chair for conference rooms, informal meeting areas, cafeterias, showrooms, lobbies, hotels or dining rooms.

##### Frame

Frame made of three-dimensional, deep-drawn, strong sheet metal, powder coated in graphite black, cement gray, gray-white, flame red or brown-green. Black, multi-purpose glides made of plastic for all types of flooring.

##### Seat and back

Unitary seat and backrest shell made of finely grained plastic (341/1 model), or with textile cover (341/5 model), or fully upholstered with cut foam, leather covered, shell covered with leather on back (341/6 model).

##### Standards



##### Fabric Grades

**Grade C = Chassis**  
**Leather = 74**



reddot design award  
best of the best 2011

DESIGN PLUS



Multi-purpose chair



Seat height      **16 1/2"**  
 Overall Height   **30 3/8"**  
 Overall Width    **21 3/4"**  
 Overall Depth    **22 7/8"**

Only the combinations listed in the following matrix are possible.

		Frame color		
		RAL 9011 Graphite black	RAL 7023 Cement gray	RAL 9002 Gray-white
Seat and back shell Polyamide	Black	•		
	Gray		•	
	White			•

		Frame color					
		RAL 9011 Graphite black	RAL 7023 Cement gray	RAL 9002 Gray-white	RAL 9003 signal white	RAL 3000 Flame red	RAL 6008 Brown-green
Textile cover	Gray-beige	C2 / 20	•	•	•	•	•
	Gray-black	C2 / 21	•	•			•
	Black	C2 / 22	•				
	Red-beige	C2 / 23				•	
	Olive-beige	C2 / 24					•

**Chassis**  
**Multi-purpose chair**

Upholstery material

**Features**

Lightweight construction  
Stackable 4-high free-standing (applies to non-Upholstered models only)  
Fully upholstered (applies to Upholstered models only)

COM	COL	Plastic shell	C2	Leather 74
USD	USD	USD	USD	USD

**341 Multi-purpose chair**



**base Powder Coated Aluminum <sup>1</sup> - model 341/1**

seat Plastic, back Plastic (indoor version)

- - 664 - -

**base Powder Coated Aluminum <sup>1</sup> - model 341/5**

seat fabric, back fabric

944 - - 934 -

**base Powder Coated Aluminum <sup>1</sup> - model 341/6**

seat leather, back leather

- 1391 - - 1341

**base Powder Coated Aluminum <sup>1</sup> - model 341/7**

seat Plastic, back Plastic (outdoor version, only available with Black frame)

- - 801 - -

<sup>1</sup> Powder Coat colors: White, Gray-White, Gray, Brown-Green, Red or Black

Note: Only the finish combinations listed in the matrix on page 127 are possible.

\* Not available in Skai faux leather

**Additional charges/reduced prices specific to range**

**USD**

**Other:** 1. a) CAL133 compliant charge (applies only to 341/6 model only. Please ensure textiles meet all appropriate flammability requirements)

154

**COM/COL Requirements (341)**

**COM (yd)**

**COL (sq.ft.)**

Seat and back

0.7

10

COM yardage and COL square footage requirements may differ from standard requirements due to leather types and/or fabric patterns. The ultimate yardage/square footage will be determined at time of testing. Please refer to Terms and Conditions for COM/COL terms.



Chassis chairs and 230 Range tables



Chassis



Chassis

## 361 range

### Ceno

Design: Läufer + Keichel Design



#### Technical Details

##### Function

Four-legged, stackable upholstered chair for furnishing conference rooms as well as high-quality restaurant and cafeteria environments.

##### Frame

Frame in solid aluminum, bright chrome-plated or powder coated in silver with a satin finish or black. Black, multi-purpose plastic glides for all types of flooring.

##### Seat and back

Seat frame in die-cast aluminum, bright chrome-plated or powder coated in silver with a satin finish or black. Resilient back shell in molded polyurethane foam around a polypropylene core, reinforced with two hexagonal rods connecting the seat and back. Seat cushion in moulded foam; seat pan in black through-dyed plastic. Back and seat cushion exchangeable, also the unitary, upholstery covers. Two-part, exchangeable cover.

##### Armrests

Armrests in black polyamide.

##### Standards

Ceno conference chairs: DIN EN 13761 and DIN EN 1022

##### Accessories

Optional stainless steel inline connector. Optionally model 361, short inline connector for linking chairs without armrests and chairs with armrests alternately with chairs without armrests or model 362 long inline connector for linking chairs with armrests.

Most of the Ceno range complies with CAL133 standards. Pricing upon request.

##### Fabric Grades

**Grade 4 = 47** Nova  
**Grade 5 = 54** Pitch  
**Grade 6 = 60** Blend  
63 Auris  
66 Lona  
68 Remix 2  
**Grade 9 = 91** Steelcut Trio 3

**Skai Faux Leather**  
**Leather = 74**  
**Leather = 87**



##### GREENGUARD™

Virtually all Wilkhahn products undergo testing and certification in accordance with GREENGUARD. The Greenguard Environmental Institute is an independent institution in the US that certifies products with regard to their suitability for interiors. Besides environmental aspects, special focus is on ensuring that products do not emit any pollutants that might be harmful to health.



Conference chair without armrests

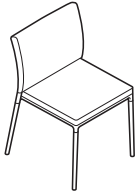

Seat height **18 1/2"**  
 Overall Height **31 1/2"**  
 Overall Width **20 1/2"**  
 Overall Depth **21 1/4"**

Conference chair without armrests - high backrest



Seat height **18 1/2"**  
 Overall Height **33 1/2"**  
 Overall Width **20 1/2"**  
 Overall Depth **21 1/4"**

Conference chair with armrests



Seat height **18 1/2"**  
 Overall Height **31 1/2"**  
 Overall Width **22 7/8"**  
 Overall Depth **21 1/4"**

Conference chair with armrests - high backrest

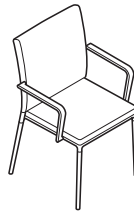

Seat height **18 1/2"**  
 Overall Height **33 1/2"**  
 Overall Width **22 7/8"**  
 Overall Depth **21 1/4"**

Dolly with 8 stacked chairs

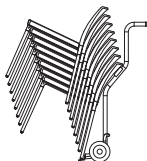

Overall Height **47 1/2"**  
 Overall Width **20 1/2"** without armrests, **22 7/8"** with armrests  
 Overall Depth **44"**

**Ceno  
Conference chairs**

Upholstery material

**Features**

Seat cushion and back cushion  
Stackable 8-high free-standing  
Stackable 8-high in cart

COM	COL*	Fabric grade 4	Fabric grade 5	Fabric grade 6 / Skai faux leather	Fabric grade 9	Leather 74*	Leather 87*
USD	USD	USD	USD	USD	USD	USD	USD

**361/5 Conference chair - medium backrest**



**frame Powder Coated Aluminum**<sup>1</sup>  
seat Upholstered, back Upholstered  
**frame Bright Chrome Aluminum**  
seat Upholstered, back Upholstered

1195	1737	1149	1241	1313	1422	1687	1955
1325	1867	1279	1371	1443	1552	1817	2085

**361/6 Conference chair w/armrests - medium backrest**

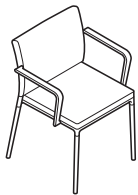

**frame Powder Coated Aluminum**<sup>1</sup>  
seat Upholstered, back Upholstered  
**frame Bright Chrome Aluminum**  
seat Upholstered, back Upholstered

1456	1998	1410	1502	1574	1683	1948	2216
1586	2128	1540	1632	1704	1813	2078	2346

<sup>1</sup> Powder Coat colors: Silver or Black

**Additional charges specific to range**

**USD**

**Other:** 1. a) CAL133 compliant charge (applies only to certain models and finishes) 201

**Accessories**

**USD**

360 Two-wheeled cart for 8 stackable chairs	1332
361 In-line connector short for linking chairs without armrests and chairs with armrests alternately with chairs without	88
362 In-line connector long for linking chairs with armrests	95
363 Magnetic seat numbers 1 set (10 consecutive numbers)	57
795/99 Stacking cushion for leather upholstered chairs	52
795/99 Double stacking cushion for leather upholstered chairs	104

**COM/COL Requirements (361/5 & 361/6)**

**COM (yd)**

**COL (sq.ft.)**

Seat and back 1.5 12.6

*COM yardage and COL square footage requirements may differ from standard requirements due to leather types and/or fabric patterns. The ultimate yardage/square footage will be determined at time of testing. Please refer to Terms and Conditions for COM/COL terms.*

\* Chairs upholstered in leather require stacking cushions.

**Ceno  
Conference chairs**

Upholstery material

**Features**

Seat cushion and back cushion  
Stackable 8-high free-standing  
Stackable 8-high in cart

COM	COL*	Fabric grade 4	Fabric grade 5	Fabric grade 6 / Skai faux leather	Fabric grade 9	Leather 74*	Leather 87*
USD	USD	USD	USD	USD	USD	USD	USD

**362/5 Conference chair - high backrest**



**frame Powder Coated Aluminum** <sup>1</sup>

seat Upholstered, back Upholstered

**frame Bright Chrome Aluminum**

seat Upholstered, back Upholstered

1321	1863	1275	1367	1439	1548	1813	2081
1451	1993	1405	1497	1569	1678	1943	2211

**362/6 Conference chair w/armrests - high backrest**

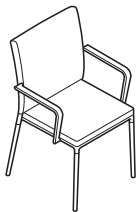

**frame Powder Coated Aluminum** <sup>1</sup>

seat Upholstered, back Upholstered

**frame Bright Chrome Aluminum**

seat Upholstered, back Upholstered

1582	2124	1536	1628	1700	1809	2074	2342
1712	2254	1666	1758	1830	1939	2204	2472

<sup>1</sup> Powder Coat colors: Silver or Black

**Additional charges specific to range**

**USD**

<b>Other:</b>	1. a) CAL133 compliant charge (applies only to certain models and finishes)	201
---------------	---	-----

**Accessories**

**USD**

360 Two-wheeled cart for 8 stackable chairs	1332
361 In-line connector short for linking chairs without armrests and chairs with armrests alternately with chairs without	88
362 In-line connector long for linking chairs with armrests	95
363 Magnetic seat numbers 1 set (10 consecutive numbers)	57
795/99 Stacking cushion for leather upholstered chairs	52
795/99 Double stacking cushion for leather upholstered chairs	104

**COM/COL Requirements (361/5 & 361/6)**

**COM (yd)**

**COL (sq.ft.)**

Seat and back	1.5	12.6
---------------	-----	------

COM yardage and COL square footage requirements may differ from standard requirements due to leather types and/or fabric patterns. The ultimate yardage/square footage will be determined at time of testing. Please refer to Terms and Conditions for COM/COL terms.

\* Chairs upholstered in leather require stacking cushions.



Ceno



Ceno Arm Chairs



Ceno chairs



Ceno chairs

## 780 range

### Insit®

Design: Wolfgang C.R. Mezger

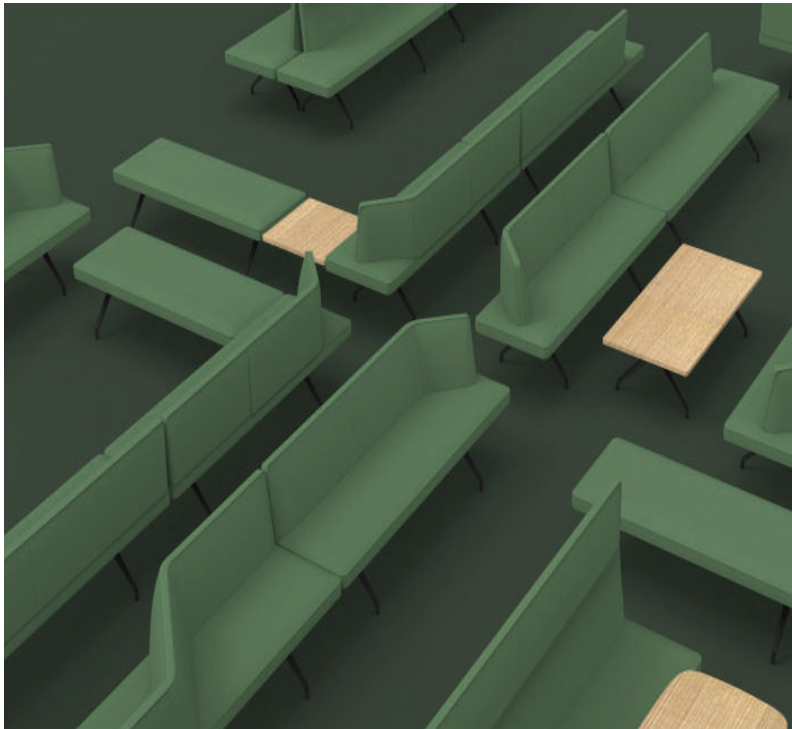

### Technical Details

#### Function

##### Upholstered Seating

Multipurpose upholstered benches with and without backrests and coordinating tables for customer service areas, foyers, lobbies, waiting spaces, areas in the middle of rooms, cross-over spaces, co-working spaces and canteens.

When sitting vertically at a seating height of 17-7/8", people can work, communicate, eat and drink at normal table heights and chairs can be added. The integrative design turns each Insit® into an individually scaleable attractive sculpture. By using connectors and side tables, the elements create a versatile system that can be linked to form complex configurations.

The range includes 2, 2-1/2, & 3-seater benches that are either straight, sloping or linked at 90-degree angles at the corners. It can come with linear backrests or backrests that are bent on one or both sides or that change direction. As well as benches without backrests.

#### Frame

Polished or high-lustre polished die-cast aluminium A-line base frame or coated white, black or with a silver satin finish. Table top bearer to connect the seat made of black coated sheet steel. Black polyamide glides as the standard version for carpets; or with felt insert for hard flooring (optional).

##### Seat and backrest

Wooden frame design with integrated panel made of beech, upholstered all the way around with contour cut foam, seat cushioning made of cold foam with a fleece overlay, fully covered in fabric or leather.

**Backrest:** Wooden frame design made of beech, upholstered with contour-cut foam all the way round, back cushioning made of contour-cut foam, fully covered with fabric or leather, depending on the model linear, sloping or bent on one or both sides or with a change of direction, with a 11-7/8" higher backrest (only in linear models). Benches without backrests (models 782/6 and 783/6).

#### Inline connectors

Inline connector, model 780, for secure bench-to-bench linkage, made of sheet steel, coated black, with four black screws.

#### Foot section finishes

- Coated white
- Polished aluminium
- Coated black
- Coated with a silver satin
- High-lustre polished aluminium



#### Standards

The upholstered benches with and without backrests comply with the DIN EN 16139-L1 standard.

##### GREENGUARD™

Virtually all Wilkhahn products undergo testing and certification in accordance with GREENGUARD. The Greenguard Environmental Institute is an independent institution in the US that certifies products with regard to their suitability for interiors. Besides environmental aspects, special focus is on ensuring that products do not emit any pollutants



that might be harmful to health.

#### Fabric Grades

**Grade 5 = 54** Pitch  
58 Evida [Faux leather]

**Grade 6 = 60** Blend  
62 Bond  
63 Auris  
66 Lona  
68 Remix 2  
69 Granit

**Grade 9 = 91** Steelcut Trio 3

**Leather = 74**

## Technical Details

### Tables

#### Frame

Models 780/1, 780/2, 780/3, 780/4, disc base made of steel, (diameter model 780/1, 780/2 and 780/4 Ø 20-1/4 in, model 780/3 Ø 37-1/2 in) with cover made of sheet steel coated white, black or in a silver satin finish or optionally brushed stainless steel or bright chrome-plated. Steel table column to match the disc base with cover coated white, black or in a silver satin finish or optionally brushed or bright chrome-plated stainless steel. Black coated sheet steel table top bearer.

#### Model 780/9

Polished or high-lustre polished die-cast aluminium A-line base frame or coated white, black or with a silver satin finish. Table top bearer to connect the seat made of black coated sheet steel. Black polyamide glides as the standard version for carpets; optionally with felt insert for hard flooring.

Model 780/10 connecting table top with connection rods made of black coated flat steel, with four screws to connect the table and bench securely. Model 780/11 Steel frame consisting of column and foot section, coated white, black or silver satin finish. Optional stainless steel look or bright chrome-plated available. Black-coated sheet steel table top bearer. Black polyamide glides as the standard version for carpets; optionally felt insert for hard flooring.

#### Core material of table top

Plywood with straight wood or plastic lipping or MDF table top with chamfered lipping all the way round

#### Finishes

##### Disc base with cover

- Coated white
- Bright chrome-plated
- Coated black
- Coated silver satin
- Brushed stainless steel

##### Table column

- Coated white
- Bright chrome-plated
- Coated black
- Coated silver satin
- Brushed stainless steel

##### Table top bearer

- Coated black

### Table top group 1 – laminate

#### Type 1

Laminate (single color) based on Wilkhahn's color and surface samples with straight wood lipping or optional double bullnose with impact-resilient profile (for an additional charge) Laminate wood decor from Wilkhahn color and surface samples with color matched straight plastic lipping.

#### Type 2

Soft matte laminate from the Wilkhahn color and surface samples with straight wood lipping. Anti-reflective, soft-touch surface with anti-fingerprint characteristics

### Table top group 2- veneer

table top tickness 1" table height 29-3/8"

#### Type 1

Beech, oak or ash veneer from Wilkhahn woodstain color samples with straight or chamfered wood lipping (for an additional charge).

#### Type 2

Maple, walnut or elm veneer from Wilkhahn woodstain color samples with straight or chamfered wood lipping (for an additional charge).

### Table top group 7 - black/ white through-dyed

Panel thickness 1/2"

Table height 28-3/4"

Table top made of through-dyed HPL (High Pressure Laminate) in black or white, chamfered lipping.

### Edge Profile

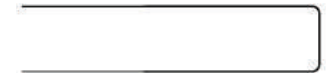

Straight plastic edging

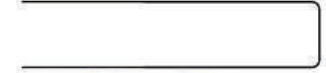

Straight wood edging



E2 - 5 Chamfered wood edging, 12mm

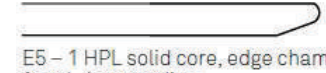

E5 - 1 HPL solid core, edge chamfered, 4 mm radius

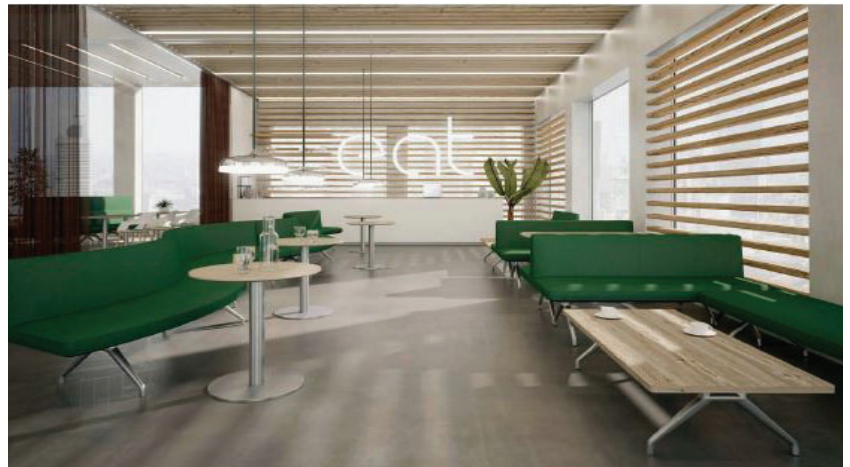

**Upholstered bench with backrest 782/5**



Seat height **17 3/4"**  
 Overall Height **33" - 45 1/4"**  
 Overall Width **65"**  
 Overall Depth **25 1/4"**

**Upholstered bench with linear backrest 783/5**

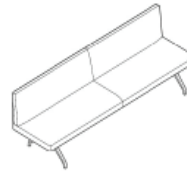

Seat height **17 3/4"**  
 Overall Height **33"-45 1/4"**  
 Overall Width **94 1/2"**  
 Overall Depth **25 1/4"**

**Bench 2-seater without backrest 782/6**



Seat height **17 3/4"**  
 Overall Height **17 3/4"**  
 Overall Width **65"**  
 Overall Depth **25 1/4"**

**Bench 3-seater without backrest 783/6**

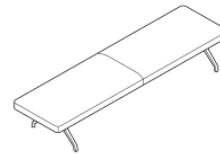

Seat height **17 3/4"**  
 Overall Height **17 3/4"**  
 Overall Width **94 1/2"**  
 Overall Depth **25 1/4"**

**Upholstered bench with linear backrest 782/51**

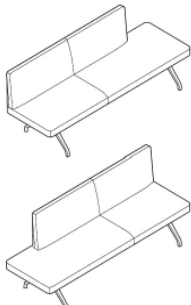

Seat height **17 3/4"**  
 Overall Height **33" / 45 1/4"**  
 Overall Width **80"**  
 Overall Depth **25 1/4"**

**Upholstered bench with linear backrest 783/51**

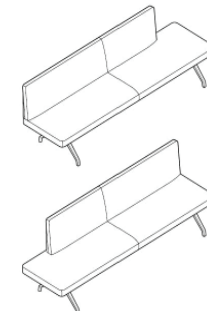

Seat height **17 3/4"**  
 Overall Height **33" / 45 1/4"**  
 Overall Width **94 1/2"**  
 Overall Depth **25 1/4"**

**Upholstered bench with bent backrest 782/52**



Seat height **17 3/4"**  
 Overall Height **33 1/4"**  
 Overall Width **80"**  
 Overall Depth **25 1/4"**

**Upholstered bench with bent backrest 783/52**

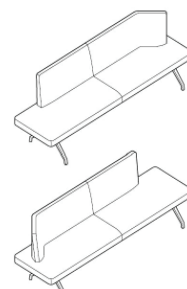

Seat height **17 3/4"**  
 Overall Height **33 1/4"**  
 Overall Width **94 1/2"**  
 Overall Depth **25 1/4"**

**Upholstered bench with opposing backrest 783/56**

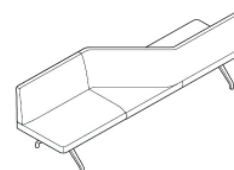

Seat height **17 3/4"**  
 Overall Height **33 1/4"**  
 Overall Width **94 1/2"**  
 Overall Depth **25 1/4"**

**60° Upholstered 3-seater bench with backrest 783/60**

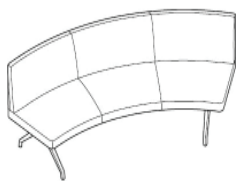

Seat height **17 3/4"**  
 Overall Height **33"**  
 Overall Width **93"**  
 Overall Depth **25 1/4"**

**Corner (2.5 x 2.5 seater) element 782/90**

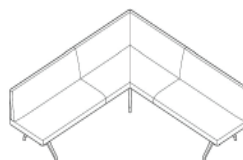

Seat height **17 3/4"**  
 Overall Height **33"/ 45 1/4"**  
 Overall Width **90 1/4"**  
 Overall Depth **90 1/4"**

**Round side table 780/1**



Overall Height **29 3/8"**  
 Overall Width **Ø 27 1/2"**  
 Overall Depth **Ø 27 1/2"**

**Square side table 780/2**



Overall Height **29 3/8"**  
 Overall Width **Ø 27 1/2"**  
 Overall Depth **Ø 27 1/2"**

**Square table 780/3**

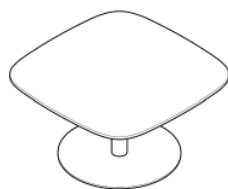

Overall Height **29 3/8"**  
 Overall Width **55 1/4"**  
 Overall Depth **55 1/4"**

**Rectangular table 780/4**

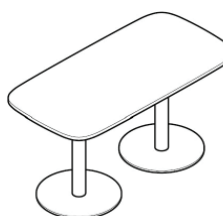

Overall Height **29 3/8"**  
 Overall Width **27 1/2"**  
 Overall Depth **55 1/4"**

**Rectngular lounge table 780/9**

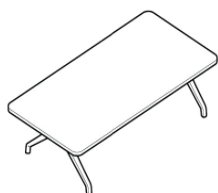

Overall Height **15"**  
 Overall Width **27 1/2"**  
 Overall Depth **55 1/4"**

**Connecting tables**

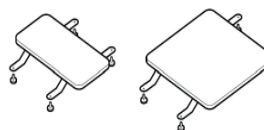

Overall Width **25 1/4"/ 15"**  
 Overall Depth **25 1/4"/ 25 1/4"**

**Insit**  
**Lounge seating**

Upholstery material

**Features**

Multipurpose upholstered benches with and without backrests and coordinating tables

COM	COL	Fabric grade 5	Fabric grade 6	Fabric grade 9	Leather 74
USD	USD	USD	USD	USD	USD

**782/5 Upholstered 2-seater bench with linear backrest**



**Powder Coated Aluminum foot section**

seat Upholstered, back Upholstered, linear backrest

5866	8249	5608	6124	6837	8199
------	------	------	------	------	------

**Additional charges**

High backrest

1158	1800	1044	1272	1591	1750
------	------	------	------	------	------

**783/5 Upholstered 3-seater bench with linear backrest**

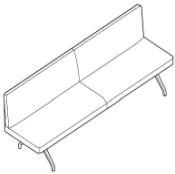

**Powder Coated Aluminum foot section**

seat Upholstered, back Upholstered, linear backrest

6850	10300	6488	7211	8209	10250
------	-------	------	------	------	-------

**Additional charges**

High backrest

1368	2402	1219	1516	1928	2352
------	------	------	------	------	------

**Additional Charges**

	USD
Polished aluminum foot section	142
High-luster polished aluminum foot section	214

**COM/COL Requirements (782/5 & 783/5)**

COM (yd)	COL (sq.ft.)
----------	--------------

\* Information pending. For exact yardage, please contact your local Wilkhahn representative.

**Insit**  
**Lounge seating**

Upholstery material

**Features**

Multipurpose upholstered benches with and without backrests and coordinating tables

COM	COL	Fabric grade 5	Fabric grade 6	Fabric grade 9	Leather 74
USD	USD	USD	USD	USD	USD

**782/6 Upholstered 2-seater bench**

**Powder Coated Aluminum foot section**  
seat Upholstered

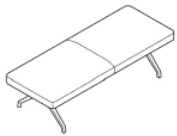

3752	4947	3617	3887	4258	4897
------	------	------	------	------	------

**783/6 Upholstered 3-seater bench**

**Powder Coated Aluminum foot section**  
seat Upholstered

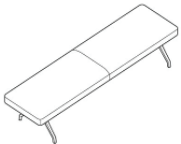

4470	6058	4297	4642	5116	6008
------	------	------	------	------	------

**Additional Charges**

	USD
Polished aluminum foot section	142
High-luster polished aluminum foot section	214

**COM/COL Requirements (782/6 & 783/6)**

COM (yd)	COL (sq.ft.)
----------	--------------

\* Information pending. For exact yardage, please contact your local Wilkhahn representative.

**Insit**  
**Lounge seating**

Upholstery material

**Features**

Multipurpose upholstered benches with and without backrests and coordinating tables

COM	COL	Fabric grade 5	Fabric grade 6	Fabric grade 9	Leather 74
USD	USD	USD	USD	USD	USD

**782/51 Upholstered 2.5-seater bench with linear backrest (open ends)**

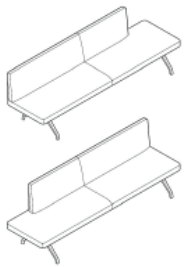

**Powder Coated Aluminum foot section**

seat Upholstered, back Upholstered,  
linear backrest with open ends

6147	8712	5866	6428	7204	8662
------	------	------	------	------	------

**Additional charges**

High backrest

1190	1821	1075	1304	1622	1771
------	------	------	------	------	------

**783/51 Upholstered 3-seater bench with linear backrest (open ends)**

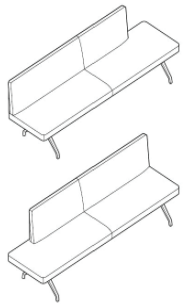

**Powder Coated Aluminum foot section**

seat Upholstered, back Upholstered,  
linear backrest with open ends

6541	9716	6220	6861	7750	9666
------	------	------	------	------	------

**Additional charges**

High backrest

1233	2120	1118	1347	1665	2070
------	------	------	------	------	------

**Additional Charges**

	USD
Polished aluminum foot section	142
High-luster polished aluminum foot section	214

**COM/COL Requirements (782/51 & 783/51)**

COM (yd)

COL (sq.ft.)

\* Information pending. For exact yardage, please contact your local Wilkhahn representative.

**Insit**  
**Lounge seating**

Upholstery material

**Features**

Multipurpose upholstered benches with and without backrests and coordinating tables

COM	COL	Fabric grade 5	Fabric grade 6	Fabric grade 9	Leather 74
USD	USD	USD	USD	USD	USD

**782/52 Upholstered 2.5- seater bench with bent backrest**



**Powder Coated Aluminum foot section**

seat Upholstered, back Upholstered, backrest bent to the right or left

6663	9271	6336	6989	7893	9221
------	------	------	------	------	------

**783/52 Upholstered 3-seater bench with bent backrest**

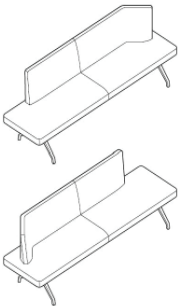

**Powder Coated Aluminum foot section**

seat Upholstered, back Upholstered, backrest bent to the right or left

6812	9665	6468	7155	8107	9615
------	------	------	------	------	------

**Additional Charges**

	USD
Polished aluminum foot section	142
High-luster polished aluminum foot section	214

**COM/COL Requirements (782/52 & 783/52)**

COM (yd)

COL (sq.ft.)

\* Information pending. For exact yardage, please contact your local Wilkhahn representative.

**Insit**  
**Lounge seating**

Upholstery material

**Features**

Multipurpose upholstered benches with and without backrests and coordinating tables

COM	COL	Fabric grade 5	Fabric grade 6	Fabric grade 9	Leather 74
USD	USD	USD	USD	USD	USD

**783/55 Upholstered 3-seater bench with bent backrest (right & left)**

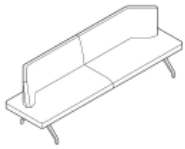

**Powder Coated Aluminum foot section**

seat Upholstered, back Upholstered,  
backrest bent to the right and left

6907	9845	6534	7279	8310	9795
------	------	------	------	------	------

**783/56 Upholstered 2 x 1.5-seater bench with backrest that changes direction**

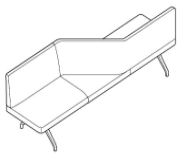

**Powder Coated Aluminum foot section**

seat Upholstered, back Upholstered,  
backrest that changes direction

7496	10707	7107	7885	8965	10657
------	-------	------	------	------	-------

**Additional Charges**

	USD
Polished aluminum foot section	142
High-luster polished aluminum foot section	214

**COM/COL Requirements (782/55 & 783/56)**

COM (yd)

COL (sq.ft.)

\* Information pending. For exact yardage, please contact your local Wilkhahn representative.

**Insit**  
**Lounge seating**

Upholstery material

**Features**

Multipurpose upholstered benches with and without backrests and coordinating tables

COM	COL	Fabric grade 5	Fabric grade 6	Fabric grade 9	Leather 74
USD	USD	USD	USD	USD	USD

**783/60 Upholstered 3-seater bench with 60° sloping backrest**

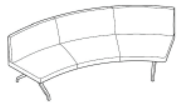

**Powder Coated Aluminum foot**  
seat Upholstered, back Upholstered,  
backrest 60° sloping backrest

10184	15373	9669	10698	12127	15323
-------	-------	------	-------	-------	-------

**Additional Charges**

**USD**

Polished aluminum foot section	142
High-luster polished aluminum foot section	214

**782/90 Upholstered 2.5 x 2.5-seater corner bench with 90° angle backrest**



**Powder Coated Aluminum foot**  
seat Upholstered, back Upholstered,  
corner element 90° angle

13104	18293	12416	13792	15694	18243
-------	-------	-------	-------	-------	-------

**Additional charges**

High backrest

2248	4463	2075	2420	2894	4413
------	------	------	------	------	------

**Additional Charges**

**USD**

Polished aluminum foot section	214
High-luster polished aluminum foot section	323

**COM/COL Requirements (783/60 & 782/90)**

**COM (yd)**

**COL (sq.ft.)**

\* Information pending. For exact yardage, please contact your local Wilkhahn representative.



Insit bench (high back) with Max table & Aula chairs

**Features**

Multipurpose tables

Table top group					
Laminate variation 1	Laminate variation 2	Black through-dyed	White through-dyed	Veneer variation 1	Veneer variation 2
USD	USD	USD	USD	USD	USD

**780/1 Ø 27.5" Round table w/ disk base (29-3/8" H)**

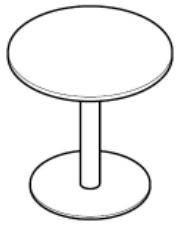

**Disc base & Column in Powder Coat**

1860 2027 1793 1998 2167 2241

**Additional charges**

Disc base with stainless steel brushed cover and column	347
Disc base with bright chrome-plated cover and column	347
Chamfered lipping (veneer variation 1)	82
Chamfered lipping (veneer variation 2)	142

**780/2 Ø 27.5" x 27.5" Square table w/ disk base (29-3/8" H)**

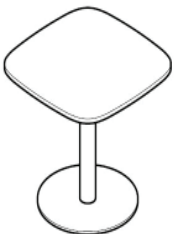

**Disc base & Column in Powder Coat**

1860 2027 1793 1998 2167 2241

**Additional charges**

Disc base with stainless steel brushed cover and column	347
Disc base with bright chrome-plated cover and column	347
Chamfered lipping (veneer variation 1)	92
Chamfered lipping (veneer variation 2)	161

**Insit  
Tables**

**Features**

Multipurpose tables

Table top group					
Laminate variation 1	Laminate variation 2	Black through-dyed	White through-dyed	Veneer variation 1	Veneer variation 2
USD	USD	USD	USD	USD	USD

**780/3 55.25" x 55.25" Square (rounded edges) table w/ disk base (29-3/8" H)**



**Disc base & Column in Powder Coat**

4666	-	4471	5061	5189	5406
------	---	------	------	------	------

**Additional charges**

Disc base with stainless steel brushed cover and column	916
Disc base with bright chrome-plated cover and column	916
Chamfered lipping (veneer variation 1)	374
Chamfered lipping (veneer variation 2)	525

**780/4 55.25" x 27.5" Rectangle (rounded edges) table w/ disk base (29-3/8" H)**

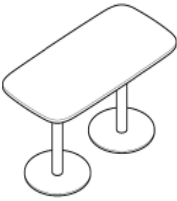

**Disc base & Column in Powder Coat**

3085	3415	3345	3610	3639	3950
------	------	------	------	------	------

**Additional charges**

Disc base with stainless steel brushed cover and column	694
Disc base with bright chrome-plated cover and column	694
Chamfered lipping (veneer variation 1)	272
Chamfered lipping (veneer variation 2)	383

**780/9 27.5" x 55.25" x 15"H Coffee table**

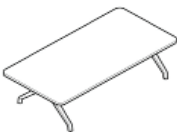

**Powder coated aluminum foot section**

2417	2747	2639	2904	2972	3282
------	------	------	------	------	------

**Additional charges**

Polished aluminum foot section	142
High-luster polished aluminum foot section	214
Chamfered lipping (veneer variation 1)	272
Chamfered lipping (veneer variation 2)	383

**Insit  
Tables**

**Features**  
Lounge tables

Table top group					
Laminate variation 1	Laminate variation 2	Black through-dyed	White through-dyed	Veneer variation 1	Veneer variation 2
USD	USD	USD	USD	USD	USD

**780/10 Connecting Tables**

**(Connect two benches linearly with integrated inline connectors)**

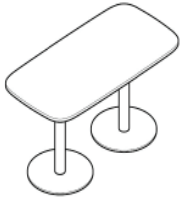

**Shelf 25.25" x 15.5" x 29-3/8"H**

964 1037 709 781 1114 1186

**Shelf 25.25" x 25.25" x 29-3/8"H**

1263 1401 892 1013 1427 1572

**Additional charges**

Chamfered lipping (veneer variation 1) for 25 1/5" x 12 3/5" surface	41
Chamfered lipping (veneer variation 2) for 25 1/5" x 12 3/5" surface	58
Chamfered lipping (veneer variation 1) for 25 1/5" x 25 1/5" surface	84
Chamfered lipping (veneer variation 2) for 25 1/5" x 25 1/5" surface	118

## 860 range

### Asienta

Design: Jehs + Laub



#### Technical Details

##### Function

Upholstered chairs and benches with backrests, benches without backrests, as well as matching tables for use in informal conference areas, such as for example prestigious lobbies, executive offices, in exclusive clubs or homes.

##### Upholstered chairs, upholstered benches with backrests and benches without backrests

##### Frame

Die-cast aluminum legs, optionally black or white powder coated, bright chrome-plated or with a chrome, matte polished finish. Surrounding under frame made of extruded aluminum profile to match the legs. Black, multi-purpose glides made of plastic for all types of flooring.

##### Seat and back

Leaf-sprung seat made of multiplex and solid wood (beech/birch). Back and side sections made of multiplex birch with flexible upper edge due to wide foam inserts that are covered with an elastic fabric. The cushioning is made of cut foam with extra padding.

##### Standards

Upholstered chairs and benches with backrests, benches without backrests: Tests are currently running in order to obtain GS and ANSI/BIFMA certification.

##### Fabric Grades

**Grade 6 = 60** Blend  
**66** Lona

**Leather = 74**

**Leather = 87**



Asienta seating and Asienta table

Armchair

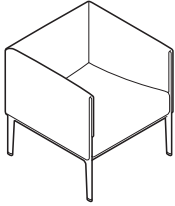

Seat height **17 3/8"**  
Overall Height **28 3/8"**  
Overall Width **27 1/2"**  
Overall Depth **27 1/8"**

Bench 2-seater

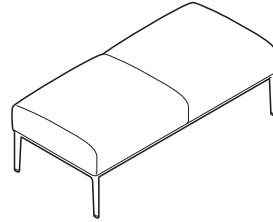

Overall Height **17 3/8"**  
Overall Width **56 3/4"**  
Overall Depth **27 1/8"**

Armchair wide

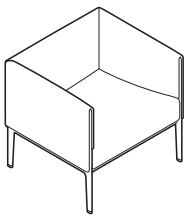

Seat height **17 3/8"**  
Overall Height **28 3/8"**  
Overall Width **30 3/4"**  
Overall Depth **27 1/8"**

Bench 3-seater

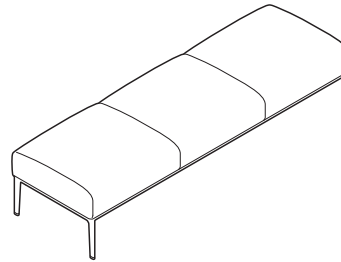

Overall Height **17 3/8"**  
Overall Width **84 5/8"**  
Overall Depth **27 1/8"**

Sofa 2-seater

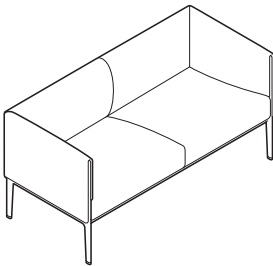

Seat height **17 3/8"**  
Overall Height **28 3/8"**  
Overall Width **59"**  
Overall Depth **27 1/8"**

Low table

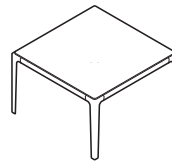

Overall Height **15 3/4"**  
Overall Width **25 5/8"**  
Overall Depth **25 5/8"**

Sofa 3-seater

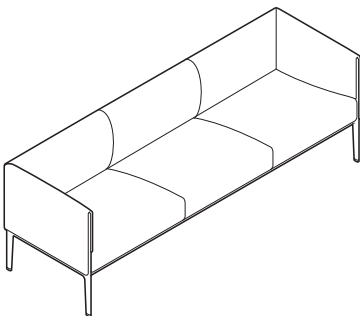

Seat height **17 3/8"**  
Overall Height **28 3/8"**  
Overall Width **85 7/8"**  
Overall Depth **27 1/8"**

Low table

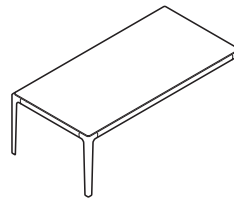

Overall Height **15 3/4"**  
Overall Width **47 1/4"**  
Overall Depth **23 5/8"**

Low table

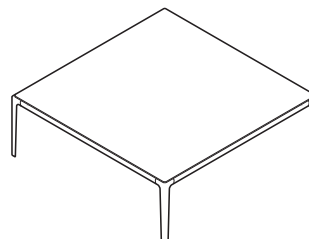

Overall Height **15 3/4"**  
Overall Width **47 1/4"**  
Overall Depth **47 1/4"**

**Asienta  
Armchairs**

**Wilkhahn**

Upholstery material

COM	COL	Fabric grade 6 */ Skai faux leather	Leather 74	Leather 87
USD	USD	USD	USD	USD

**861/5 Armchair**

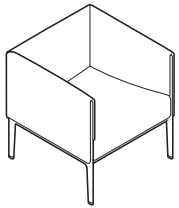

**frame Powder Coated Aluminum** <sup>1</sup>

seat Upholstered, back Upholstered

**frame Matte Polished Aluminum**

seat Upholstered, back Upholstered

**frame Bright Chrome Aluminum**

seat Upholstered, back Upholstered

3128 4184 3088 4134 5356

3777 4833 3737 4783 6005

3492 4548 3452 4498 5720

*\*Only available in Fabrics 60, 66 & 67*

**861/6 Armchair wide**

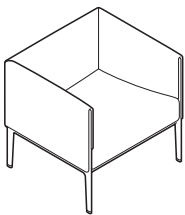

**frame Powder Coated Aluminum** <sup>1</sup>

seat Upholstered, back Upholstered

**frame Matte Polished Aluminum**

seat Upholstered, back Upholstered

**frame Bright Chrome Aluminum**

seat Upholstered, back Upholstered

3351 4567 3311 4517 5858

4000 5216 3960 5166 6507

3715 4931 3675 4881 6222

*\*Only available in Fabrics 60, 66 & 67*

<sup>1</sup> Powder Coat colors: White or Black

**COM/COL Requirements (861/5 & 861/6)**

	COM (yd)	COL (sq.ft.)
Complete armchair (861/5 model)	4	62
Complete armchair (861/6 model)	4	62

COM yardage and COL square footage requirements may differ from standard requirements due to leather types and/or fabric patterns. The ultimate yardage/square footage will be determined at time of testing. Please refer to Terms and Conditions for COM/COL terms.

Upholstery material

COM	COL	Fabric grade 6 */ Skai faux leather	Leather 74	Leather 87
USD	USD	USD	USD	USD

862/5 Sofa 2-seater

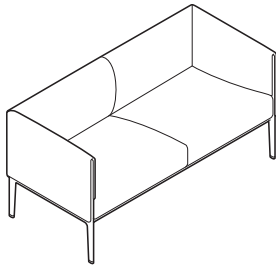

**frame Powder Coated Aluminum** <sup>1</sup>

seat Upholstered, back Upholstered

4524 5977 4484 5927 7842

**frame Matte Polished Aluminum**

seat Upholstered, back Upholstered

5480 6933 5440 6883 8798

**frame Bright Chrome Aluminum**

seat Upholstered, back Upholstered

5093 6546 5053 6496 8411

*\*Only available in Fabrics 60, 66 & 67*

863/5 Sofa 3-seater

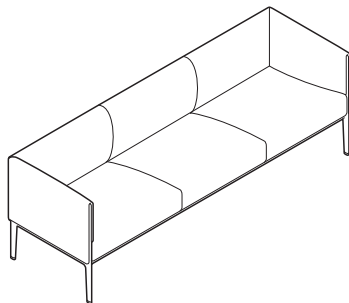

**frame Powder Coated Aluminum** <sup>1</sup>

seat Upholstered, back Upholstered

6317 8071 6277 8021 10639

**frame Matte Polished Aluminum**

seat Upholstered, back Upholstered

7407 9161 7367 9111 11729

**frame Bright Chrome Aluminum**

seat Upholstered, back Upholstered

6973 8727 6933 8677 11295

*\*Only available in Fabrics 60, 66 & 67*

<sup>1</sup> Powder Coat colors: White or Black

**COM/COL Requirements (862/5 & 862/6)**

**COM (yd)**

**COL (sq.ft.)**

Complete settee (862/5 model)

6

98

Complete settee (863/5 model)

7.1

123

*COM yardage and COL square footage requirements may differ from standard requirements due to leather types and/or fabric patterns. The ultimate yardage/square footage will be determined at time of testing. Please refer to Terms and Conditions for COM/COL terms.*

**Asienta  
Benches**

**Wilkhahn**

Upholstery material

COM	COL	Fabric grade 6 */ Skai faux leather	Leather 74	Leather 87
USD	USD	USD	USD	USD

**864/3 Bench 2-seater**

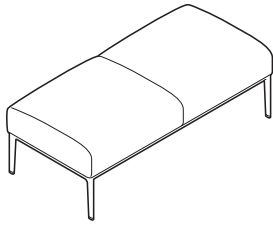

**frame Powder Coated Aluminum** <sup>1</sup>

seat Upholstered, back Upholstered

**frame Matte Polished Aluminum**

seat Upholstered, back Upholstered

**frame Bright Chrome Aluminum**

seat Upholstered, back Upholstered

2594	3607	2554	3557	4535
3473	4486	3433	4436	5414
3116	4129	3076	4079	5057

*\*Only available in Fabrics 60, 66 & 67*

**865/3 Bench 3-seater**

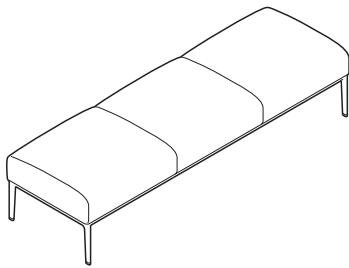

**frame Powder Coated Aluminum** <sup>1</sup>

seat Upholstered, back Upholstered

**frame Matte Polished Aluminum**

seat Upholstered, back Upholstered

**frame Bright Chrome Aluminum**

seat Upholstered, back Upholstered

3257	4228	3217	4178	6223
4291	5262	4251	5212	7257
3882	4853	3842	4803	6848

*\*Only available in Fabrics 60, 66 & 67*

<sup>1</sup> Powder Coat colors: White or Black

**COM/COL Requirements (864/3 & 865/3)**

	COM (yd)	COL (sq.ft.)
Complete bench (864/3 model)	2.5	42
Complete bench (865/3 model)	3	96

*COM yardage and COL square footage requirements may differ from standard requirements due to leather types and/or fabric patterns. The ultimate yardage/square footage will be determined at time of testing. Please refer to Terms and Conditions for COM/COL terms.*

**Asienta  
Low Tables**

Table top group

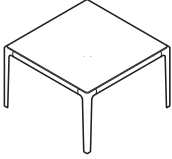
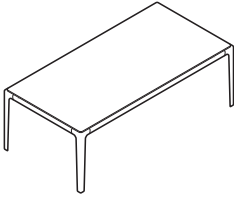
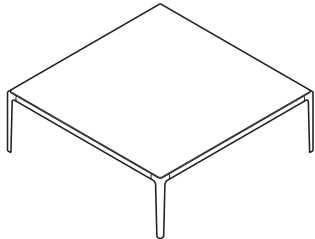
		Veneer variation 1 USD	Veneer variation 2 USD	Glass USD
<b>860/1 Low table</b> 	frame Powder Coated Aluminum <sup>1</sup>	3071	3189	2686
	frame Matte Polished Aluminum	3896	4014	3511
	frame Bright Chrome Aluminum	3546	3664	3161
<b>860/2 Low table</b> 	frame Powder Coated Aluminum <sup>1</sup>	3330	3434	3201
	frame Matte Polished Aluminum	4336	4440	4207
	frame Bright Chrome Aluminum	3915	4019	3786
<b>860/3 Low table</b> 	frame Powder Coated Aluminum <sup>1</sup>	3845	4051	4357
	frame Matte Polished Aluminum	5055	5261	5567
	frame Bright Chrome Aluminum	4555	4761	5067

<sup>1</sup> Powder Coat colors: White or Black



Asienta seating and Asienta table



Asienta seating and Asienta table

## Fabric grades

---

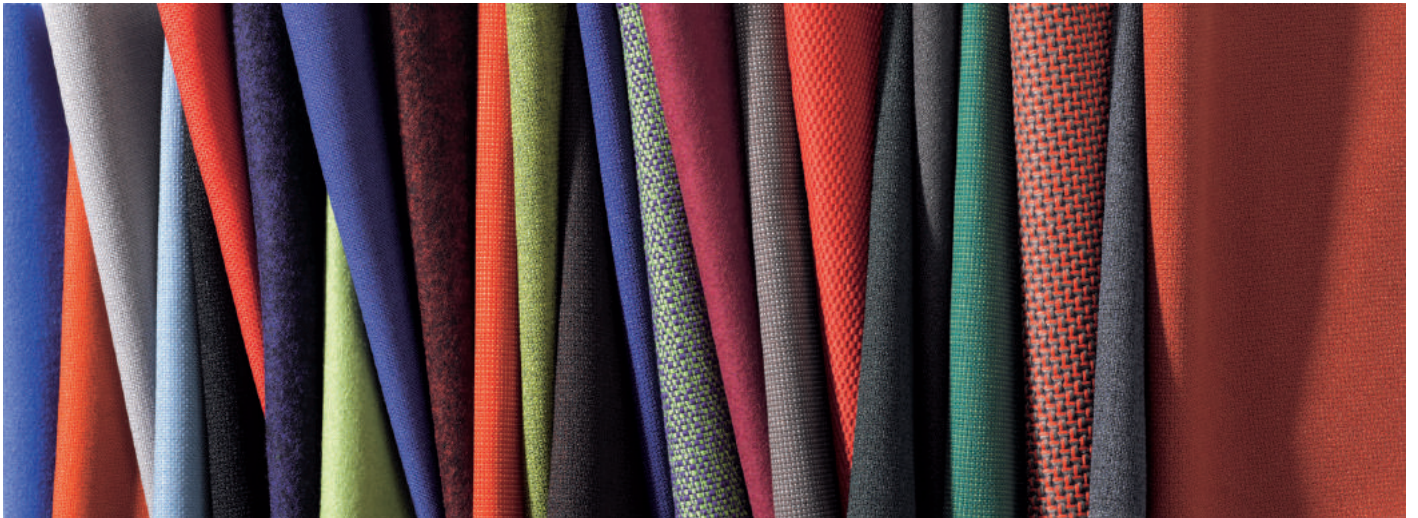

Fabric grades

Fabric grade 3

**35 Fiberflex**

**Description** - 100% Polyester 510 g/lin. m, width 63"

**Test results** - Abrasion: 70.000 rubs, BS EN ISO 12947-2 (Martindale) Lightfastness: 5-6, BS EN ISO 105-B02 Method 2 Pilling: 5, BS EN ISO 12945-2 Fastness to rubbing: dry 4-5, wet 4-5, EN ISO 105-X12 Flame resistance: CAL 117 E EN 1021-1 when covering CMHR-foam density min. 35 kg/m<sup>3</sup> EN 1021-2 when covering CMHR-foam density min. 50 kg/m<sup>3</sup>

**Cleaning** - periodical vacuum cleaning, professional cleaning with dry foam

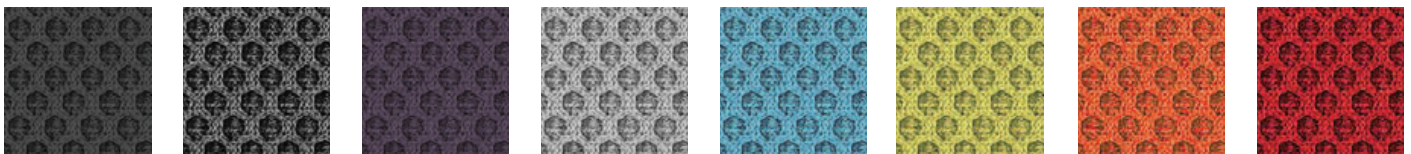

35/99  
Black

35/25  
Anthracite

35/64  
Dark Blue

35/11  
Gray

35/63  
Light Blue

35/56  
Green

35/34  
Orange

35/89  
Red



35/29  
Brown

**37 Racer**

**Description** - 100% Polyester 440 g/lin. m, width 63"

**Test results** - Abrasion: 90,000 rubs, BS EN 14465, BS EN ISO 12947-2 (Martindale) Lightfastness: 5-7, BS EN ISO 105-B02 Method 2 Pilling: 4-5, BS EN ISO 12945-2 Fastness to rubbing: dry 4-5, wet 4-5, EN ISO 105-X12 Flame resistance: CAL 117 E BS 476 Part 7, ASTM E 84, EN 1021-1+2 EN 1021-1 when covering CMHR-foam density min. 35 kg/m<sup>3</sup> EN 1021-2 when covering CMHR-foam density min. 50 kg/m<sup>3</sup>

**Cleaning** - periodical vacuum cleaning, professional cleaning with dry foam

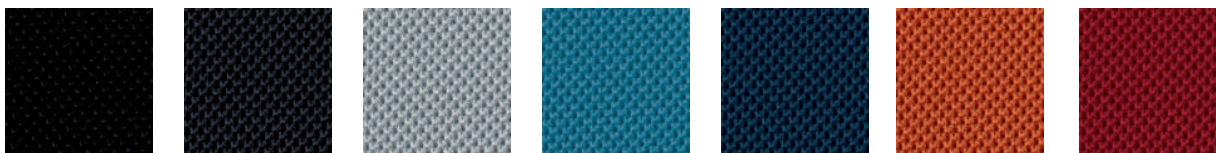

37/99  
Black

37/25  
Anthracite

37/95  
Light Gray

37/63  
Turquoise

37/57  
Petrol

37/34  
Orange

37/89  
Red

\* The digital sample colors might differ from the originals

Fabric grades

Fabric grade 4

**41 Formstrick**

**Description** - 100% Polyamide hybrid. Weight: 750g/m2

**Test results** - Abrasion: 100,000 rubs, BS EN ISO 12947-2 (Martindale) Lightfastness: 6, BS EN ISO 105-B02 Method 2 Pilling: 5, DIN EN ISO 12945-2 Fastness to rubbing: dry 5, wet 5, DIN EN ISO 105-X12 Flame resistance: on request

**Cleaning** - periodical vacuum cleaning, professional cleaning with dry foam

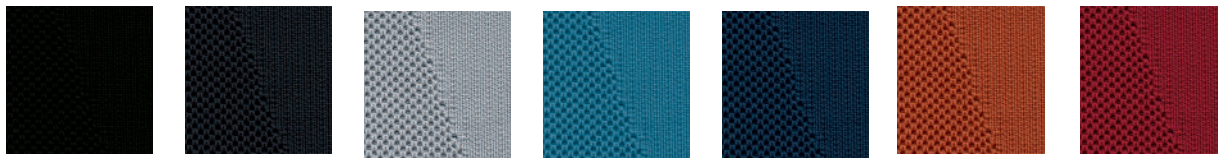

41/99  
Black

41/25  
Anthracite

41/95  
Light Gray

41/63  
Turquoise

41/57  
Petrol

41/34  
Orange

41/89  
Red

**47 Nova**

**Description** - 100% Polyester 560 g/lin. m, width 55"

**Test results** - Abrasion: 50.000 rubs, BS EN ISO12947-2 (Martindale) Lightfastness: 5-7, BS EN ISO 105-B02 Method 2 Pilling: 5, BS EN ISO 12945-2 Fastness to rubbing: dry 4-5, wet 4-5, EN ISO 105-X12

Flame resistance: CAL 117 E EN 1021-1 when covering PUR-foam density min. 22 kg/m<sup>3</sup> EN 1021-2 when covering CMHR-foam density min. 36 kg/m<sup>3</sup>

**Cleaning** - Fixed covers: periodical vacuum cleaning, professional cleaning with dry foam. Removable covers: (P)



47/10  
Black

47/14  
Gray

47/71  
Midnight  
Blue

47/15  
Light Gray

47/21  
Pale Gray

47/32  
Ivory

47/41  
Dark  
Brown

47/66  
Dark Red

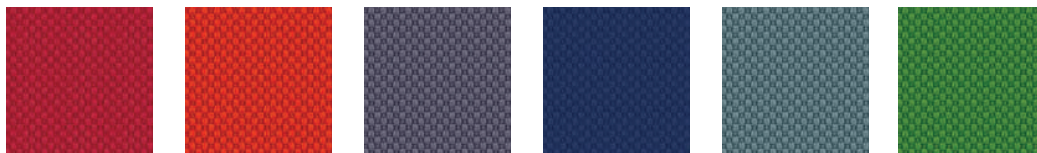

47/60  
Red

47/63  
Orange

47/70  
Violet Blue

47/73  
Dark blue

47/77  
Gray/Blue

47/91  
Green

\* The digital sample colors might differ from the originals

Fabric grade 5

54 Pitch

**Description** - 100% Trevira CS 470 g/lin. m, width 55"

**Test results** - Abrasion: 100.000 rubs, BS EN ISO 12947-2 (Martindale) Lightfastness: 5, BS EN ISO 105-B02

Method 2 Pilling: 4-5, BS EN ISO 12945-2 Fastness to rubbing: dry 4-5, wet 4-5, EN ISO 105-X12

Flame resistance: CAL 117 E DIN 4102-1 B1 NF P 92-503-507 M1 ÖNORM A 3800-1 B1/Q1/TR1 BS 5852 when covering CMHR-foam EN 1021-1/-2 when covering PUR-foam density min. 30 kg/m<sup>3</sup> UNI VF 9175 1IM when covering CMHR-foam

**Cleaning** - Fixed covers: periodical vacuum cleaning, professional cleaning with dry foam Removable covers: (P)

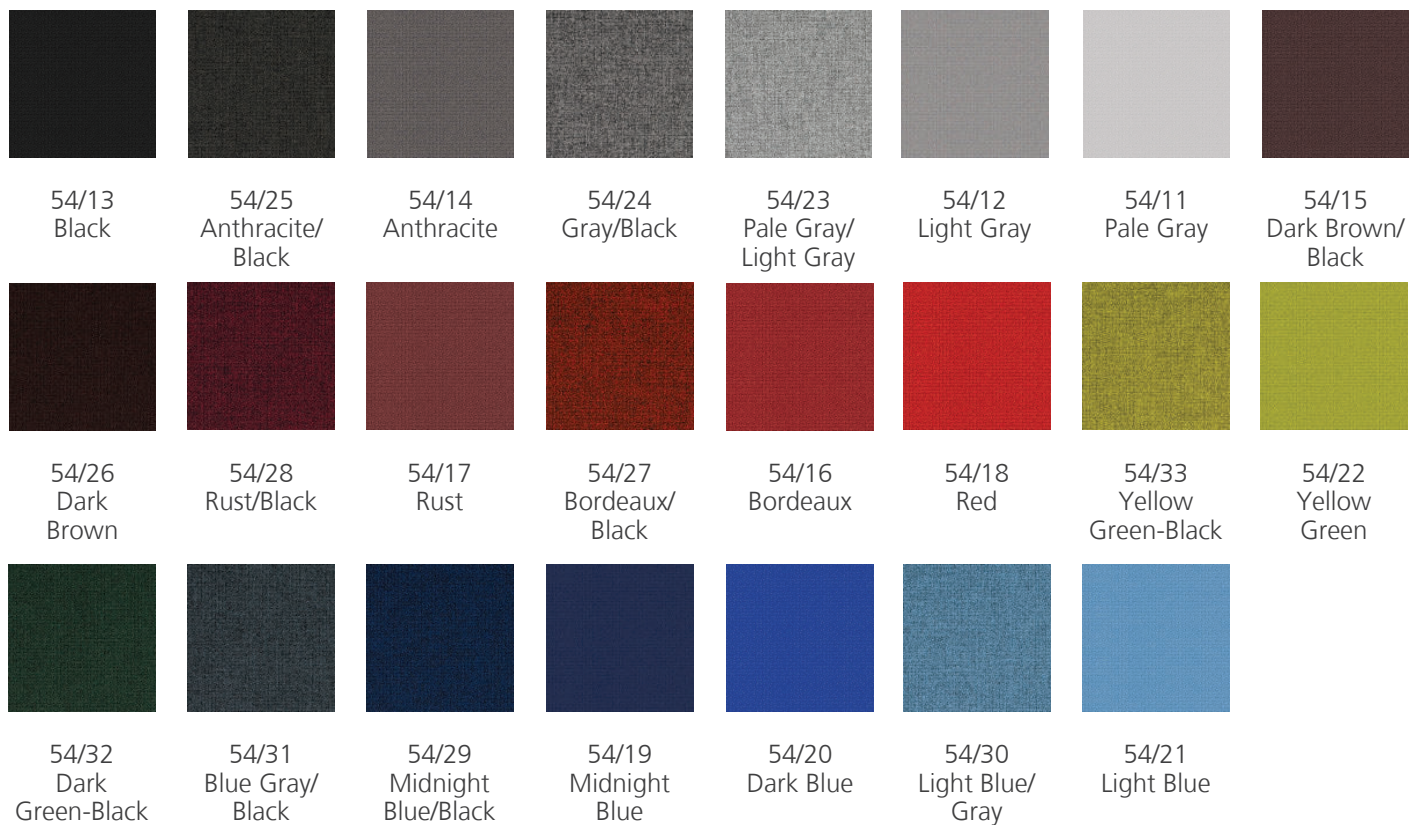

\* The digital sample colors might differ from the originals

Fabric grades

Fabric grade 5

**58 Evida- faux leather (Available for Insit only)**

**Description** - 50% renewable, 30 % natural and roughly 20% other materials

**Test results** - Abrasion Resistance: DIN EN ISO 54702: > 50,000 Martindale. Fulfills DIN EN 713 disinfectant resistant. Flame Retardent: EN10211+ 2, BS 5852 ISO+ , fulfills OekoTex ® Standard 100 fulfills medical standard, DIN EN ISO 109935+ 10 Lightfast

**Cleaning** - Please remove any soiling immediately (by applying warm and mild soapy water, microfibre cloth, a soft handheld brush). Please don't use any solvents.

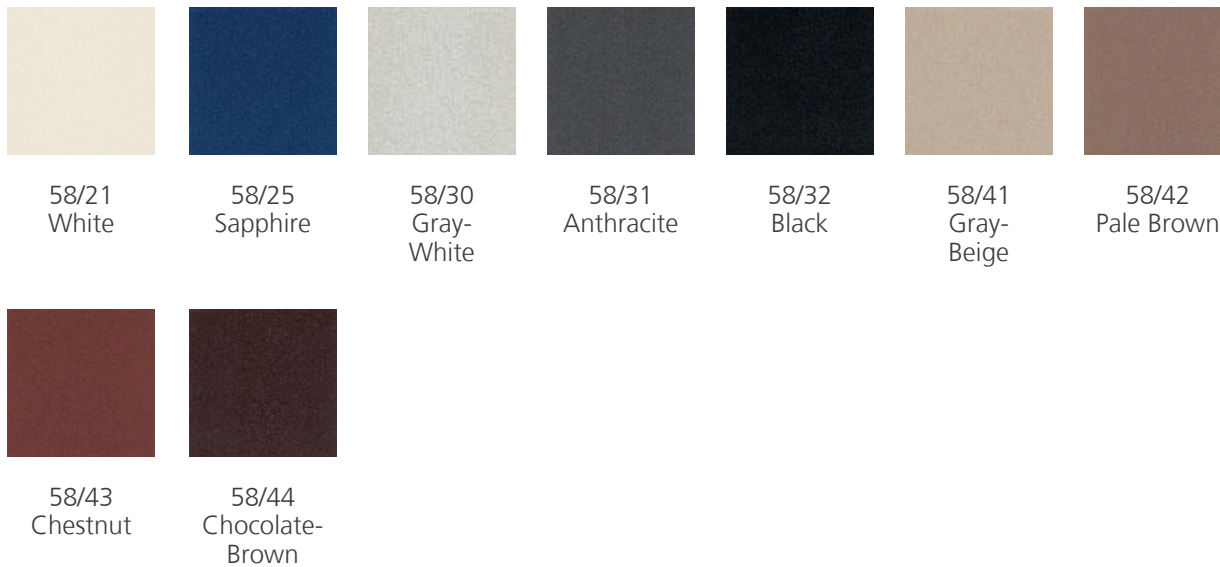

\* The digital sample colors might differ from the originals

Fabric grade 6

**60 Blend**

**Description** - 100% new wool 600 g/lin. m, width 55"

**Test results** - Abrasion: 50.000 rubs, BS EN ISO 12947-2 (Martindale) Lightfastness: 5, BS EN ISO 105-B02 Method 2 Pilling: 3-4, BS EN ISO 12945-2 Fastness to rubbing: dry 4, wet 4, EN ISO 105-X12 Flame resistance: CAL 117 E BS 5852 when covering FR-foam BS 7176 low hazard when covering CMHR-foam density min. 35 kg/m<sup>3</sup> BS 7176 medium hazard when covering CMHR-foam density min. 35 kg/m<sup>3</sup> EN 1021-1/-2 when covering CMHR-foam density min. 35 kg/m<sup>3</sup>

**Cleaning** - Fixed covers: periodical vacuum cleaning, professional cleaning with dry foam. Removable covers: P

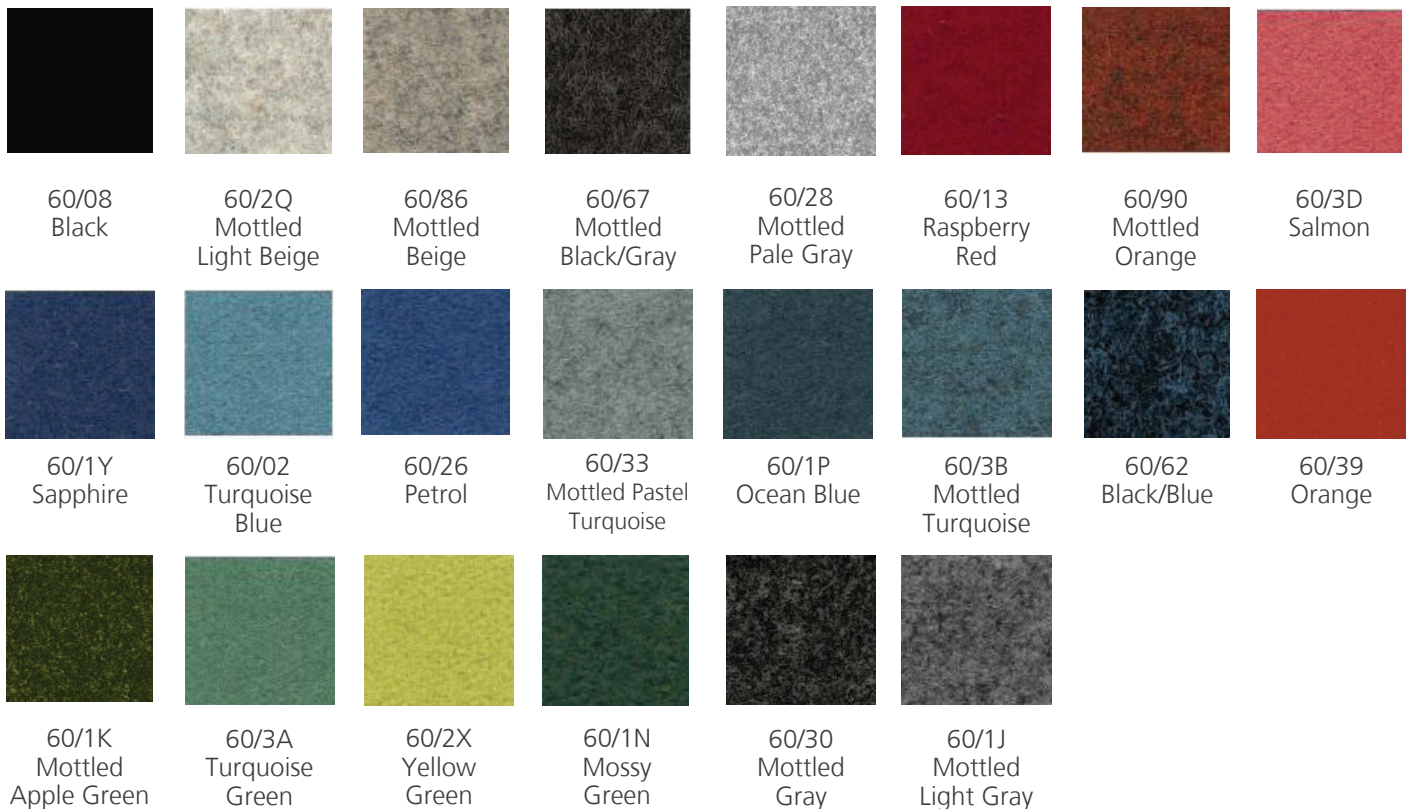

\* The digital sample colors might differ from the originals

Fabric grade 6

**62 Bond**

**Description** - 100% Trevira CS 480 g/lin. m, width 55" yarn dyed

**Test results** - Abrasion: 100.000 rubs, BS EN ISO 12947-2 (Martindale) Lightfastness: 6, BS EN ISO 105-B02 Method 2 Pilling: 4-5, BS EN ISO 12945-2 Fastness to rubbing: dry 4-5, wet 4-5, EN ISO 105-X12 Flame resistance: CAL 117 E DIN 4102-1 B1 NF P 92501-7 M1 ÖNORM A 3800-1 B1/Q1/2 BS 5852 when covering CMHR-foam EN 1021-1/-2 when covering PUR-foam density min. 30 kg/m<sup>3</sup> UNI VF 9175 1IM when covering CMHR-foam

**Cleaning** - periodical vacuum cleaning, professional, cleaning with dry foam

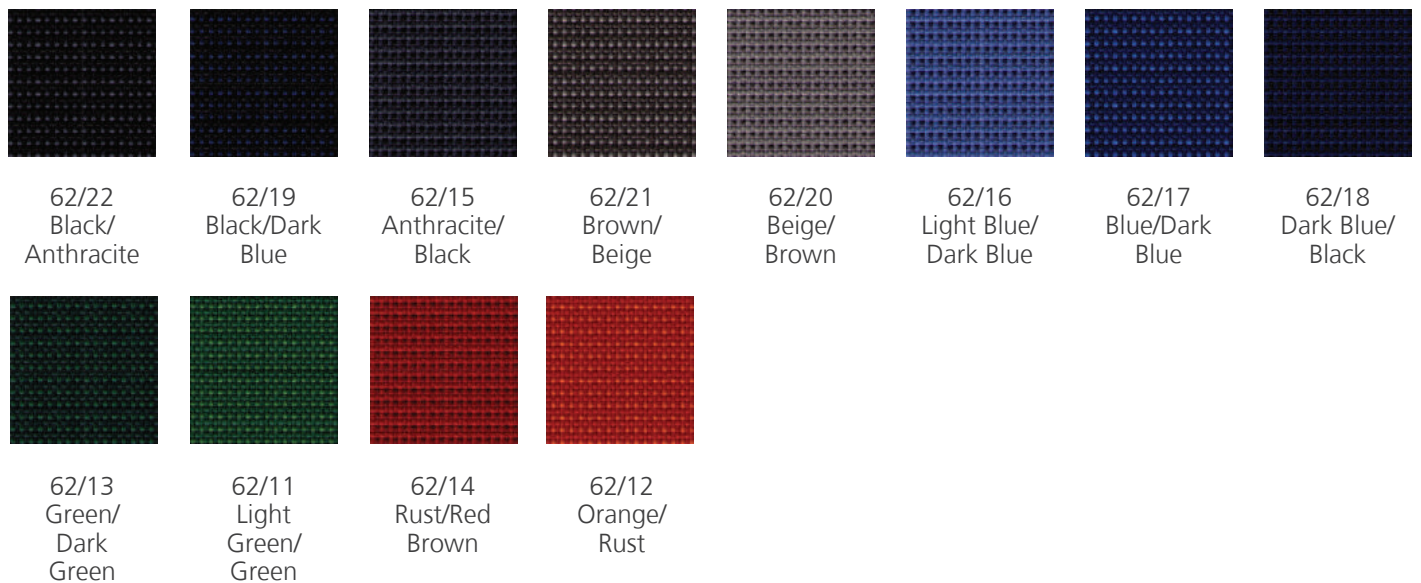

\* The digital sample colors might differ from the originals

Fabric grade 6

**63 Auris**

**Description** - 100% new wool 520 g/lin. m, width 55"

**Test results** - Abrasion: 50,000 rubs, BS EN ISO

12947-2 (Martindale) Lightfastness: 5, BS EN ISO 105-B02 Method 2 Pilling: 5, BS EN ISO 12945-2 Fastness to rubbing: dry 4, wet 4, EN ISO 105-X12 Flame resistance: CAL 117 E BS 5852 when covering CMHR-foam density min. 35 kg/m<sup>3</sup> EN 1021-1/-2 when covering CMHR-foam density min. 35 kg/m<sup>3</sup> UNI 9175/FA1 IM when covering FR-foam density min. 35 kg/m<sup>3</sup>

**Cleaning** - Fixed covers: periodical vacuum cleaning, professional cleaning with dry foam. Removable covers: P

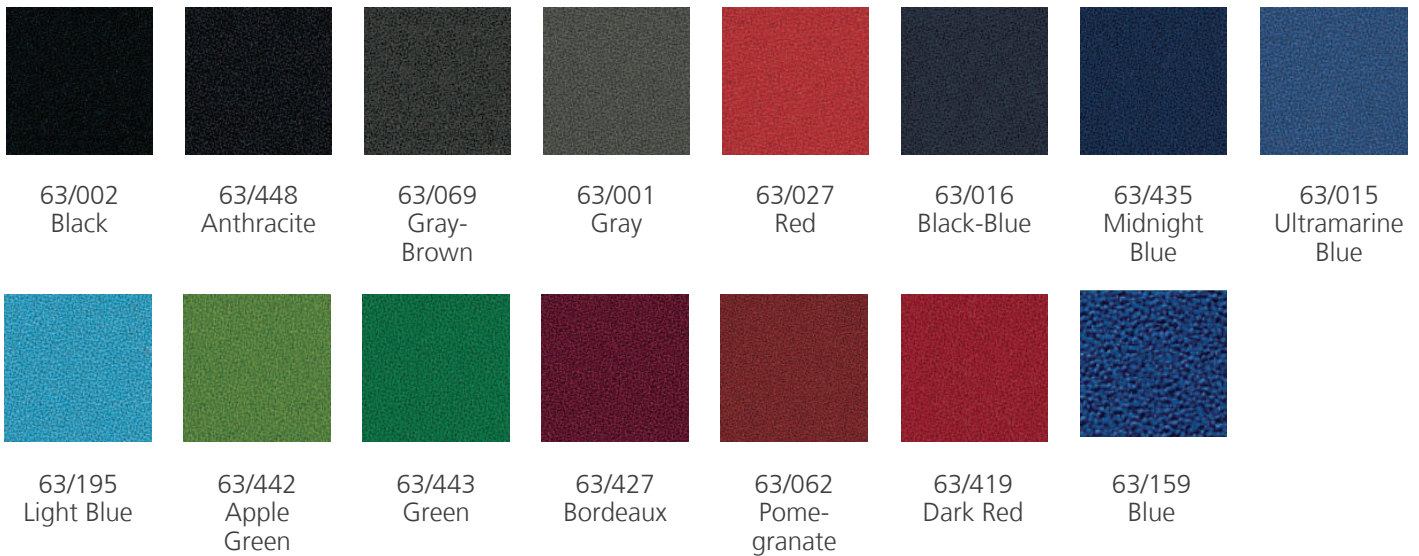

\* The digital sample colors might differ from the originals

Fabric grade 6

**66 Lona**

**Description** - 85% new wool, 15% polyamide 520 g/lin. m, width 55"

**Test results** - Abrasion: 150.000 rubs, BS EN ISO 12947-2 (Martindale) Lightfastness: 5-7, BS EN ISO 105-B02 Method 2 Pilling: 4, BS EN ISO 12945-2 Fastness to rubbing: dry 4-5, wet 4-5, EN ISO 105-X12 Flame resistance: CAL 117 E, ÖNORM A 3800-1 Q1, ÖNORM B 3852 flame retardant when covering PUR-foam, B2 BS 7176 medium hazard when covering CMHR-foam density min. 35 kg/m<sup>3</sup>, EN 1021-1/-2 when covering PUR-foam density min. 22 kg/m<sup>3</sup>

**Cleaning** - Fixed covers: periodical vacuum cleaning, professional cleaning with dry foam Removable covers: P

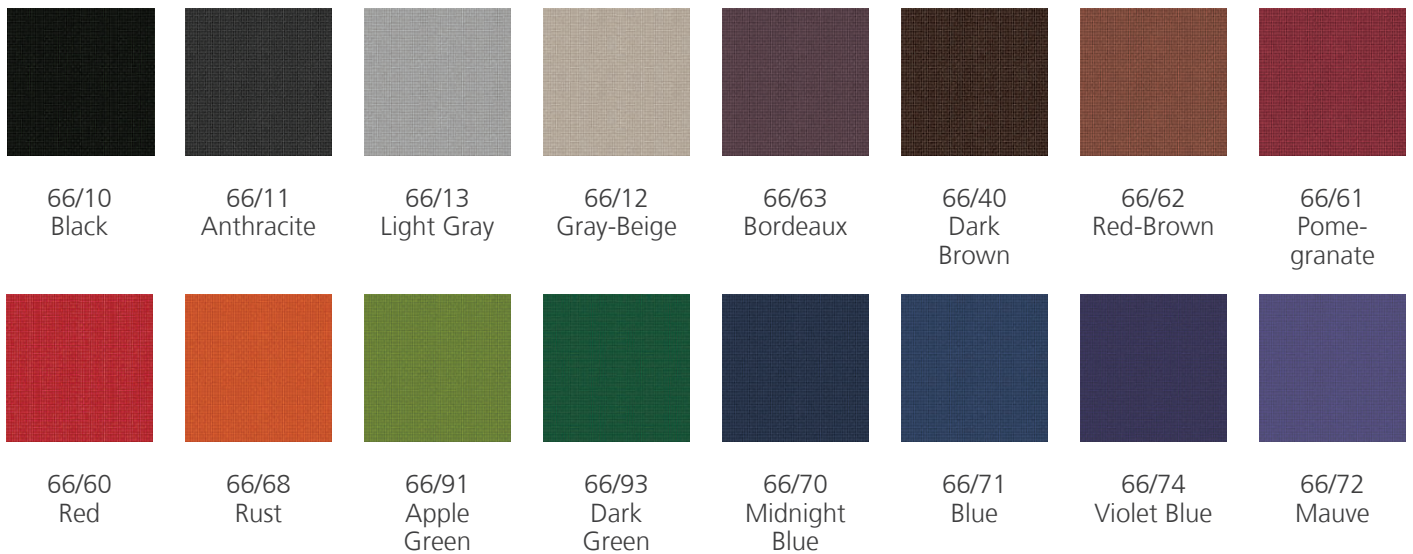

\* The digital sample colors might differ from the originals

Fabric grades

Fabric grade 6

**69 Granit**

**Description** - 50% new wool, 50% cotton 750 g/lin. m, width 54" yarn dyed

**Test results** - Fastness to rubbing: ca. 45.000 rubs, BS EN ISO 12947-2 (Martindale) Lightfastness: 5-6, BS EN ISO 105-B02 Method 2 Pilling: 4-5, BS EN ISO 12945-2 Fastness to rubbing: dry 4-5, wet 4, EN ISO 105-X12

Flame resistance: CAL 117 E, DIN 66084 P-c when covering PUR-foam B3 density min. 22 kg/m<sup>3</sup>, EN 1021-1/-2 when covering PUR-foam B3 density min. 22 kg/m<sup>3</sup>

**Cleaning** - Fixed covers: periodical vacuum cleaning, professional cleaning with dry foam Removable covers: Ⓟ

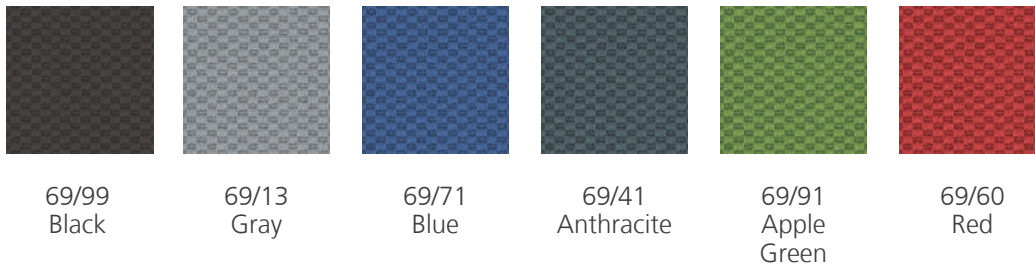

\* The digital sample colors might differ from the originals

Fabric grade 6

**68 Remix 2**

**Description** - 90% new wool, worsted 10% nylon, 415 g/lin. m, width 54"

**Test results** - Abrasion: approx. 100.000 rubs, BS EN ISO 12947 (Martindale) Lightfastness: 5-7, BS EN ISO 105-B02 Method 2 Pilling: 4, BS EN ISO 12945-2 Fastness to rubbing: dry 4-5, wet 4, EN ISO 105-X12 Flame resistance: EN 1021-1/2 ignition source 0-1. BS 5852 part 1. ÖNORM B1/Q1. NF D 60 013. UNI 9175 1IM. US Cal. Bull. 117-2013. AS/NZS 1530.3. AS/NZS 3837 Class 2. IMO FTP Code 2010:Part 8. Crib 5 and B2 when flame protected.

**Cleaning** - Fixed covers: periodical vacuum cleaning, professional cleaning with dry foam Removable covers: (P)

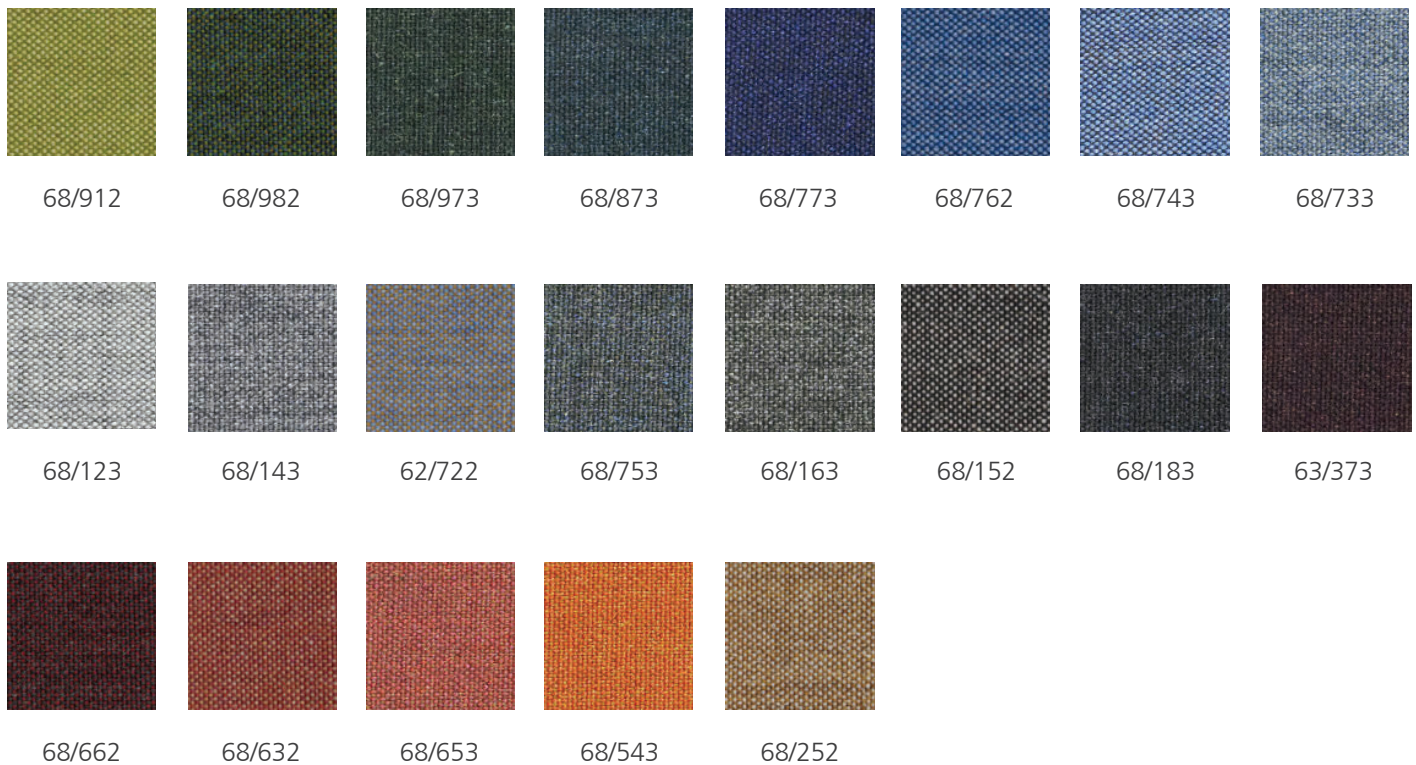

\* The digital sample colors might differ from the originals

Fabric grade 9

**91 Steelcut Trio 3**

**Description** - 90% wool, worsted 10% nylon, 770 g/lin. m, Width approx. 54"

**Test results** - Abrasion: approx. 100,000 rubs, BS EN ISO 12947 (Martindale) Lightfastness: 5-7, BS EN ISO 105-B02 method 2 Pilling: 4, EN ISO 12945 Fastness to rubbing: Dry 4-5, wet 3-5, EN ISO 105-X12

Flame retardancy: please state when ordering EN 1021-1/2. BS 5852 part 1. DIN 4102 B2. Önorm B1/Q1.

NF D 60 013. UNI 9175 1IM. US Cal. Bull. 117, – 2013. NFPA 260. AS/NZS 3837. IMO FTP Code 2010: Part 8 B2 and Crib 5 and SN 198. 898 5.3 with flame-retardant finish.

**Cleaning** - Permanent covers: vacuum them regularly and have them dry cleaned. Replaceable covers:

W x9 4 n. (P)

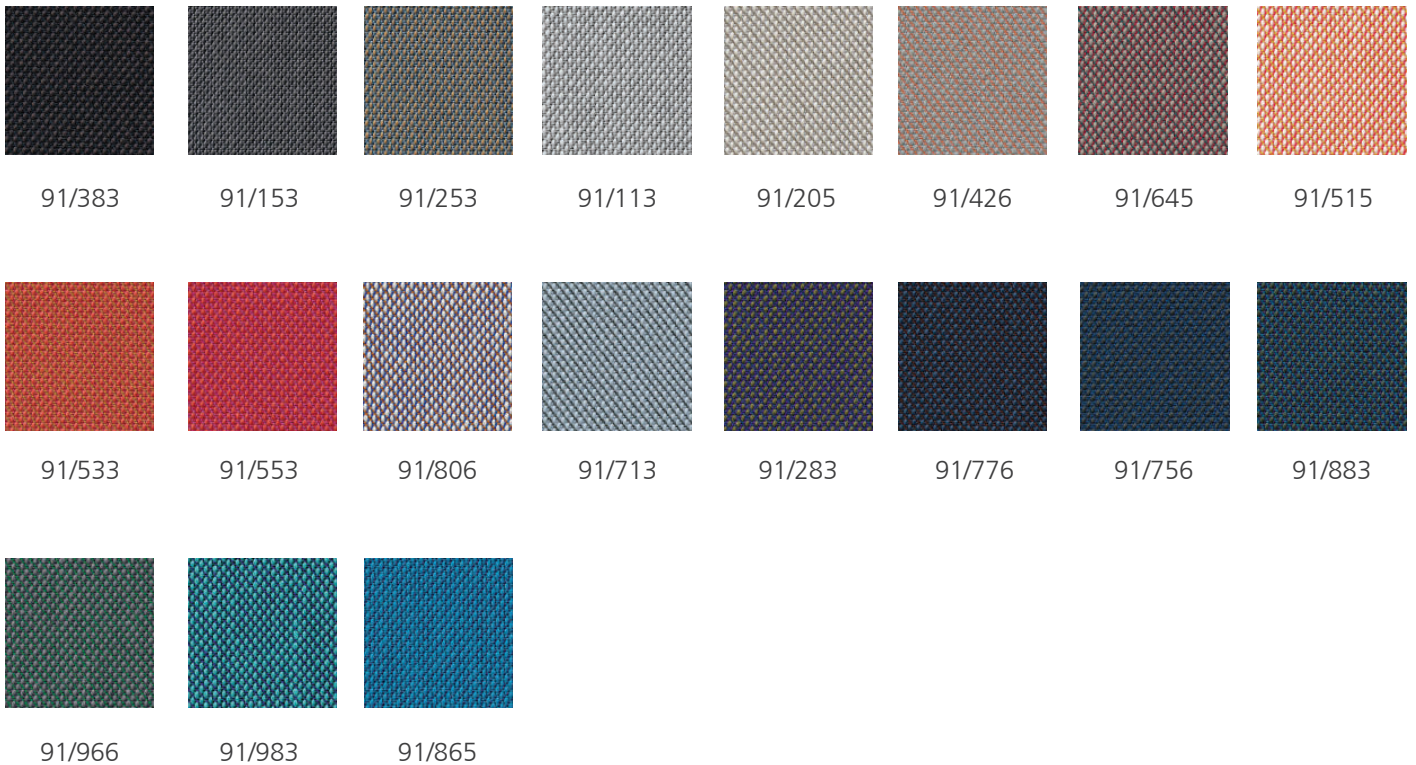

\* The digital sample colors might differ from the originals

**Chassis**

**C2**

**Description** - 24% Polyester, 22% flax/linen, 20% viscose, 20% polyacrylics, 8% wool, 6% cotton 750 g/lin. m, width 52"

**Test results** - Abrasion: min. 45.000 rubs, BS EN ISO 12947-2 (Martindale) Lightfastness: 4-5, BS EN ISO 105-B02 Method 2 Pilling: 3-4, BS EN ISO 12945-2 Fastness to rubbing: dry 4, wet 2-3, EN ISO 105-X12

**Cleaning** - Fixed covers: periodical vacuum cleaning, professional cleaning with dry foam  
Removable covers: (P)

**C2**



C2/22-Black

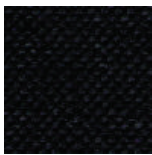

C2/21-Gray Black

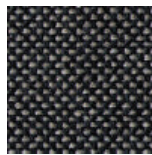

C2/20-Gray Beige

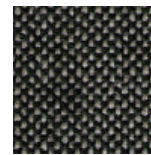

C2/24-Olive Beige

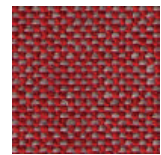

C2/23-Red Beige

\* The digital sample colors might differ from the originals

**Skai Faux Leather**

**Description** - High quality upholstery fabric with soft nappa finish and a classic leather grain.

**Material composition** - approx. 1% PU-finish, approx. 73% PVC-compund, approx. 26% CO-fabric.

Thickness approx. 1/16"

**Test results** - Abrasion Resistance: DIN EN ISO 5470-2: >50,000 Martindale

**Cleaning** - Remove dirt or stains with a damp, absorbent cloth and immediately rub over the surface with a dry woollen cloth.



\* The digital sample colors differ might from the originals

**Leather 74**

**Description** - Furniture quality cowhide. Please allow for deviations with regard to color and texture.

**Test results** - Lightfastness: 6, BS EN ISO 105-B02 Method 2 Flame resistance: CAL 117 A, DIN 4102-1 B1/B2, NF P 92-503 M2, ÖNORM A 3800-1, B1/Q1/TR1, BS 5852-3 when covering PUR-foam density min. 22 kg/m<sup>3</sup>, EN 1021-1/-2 when covering PUR-foam density min. 22 kg/m<sup>3</sup>, UNI 9175 1IM when covering CMHR-foam density min. 25 kg/m<sup>3</sup>

**Cleaning** - Remove dirt or stains with a damp, absorbent cloth and immediately rub over the surface with a dry woollen cloth.

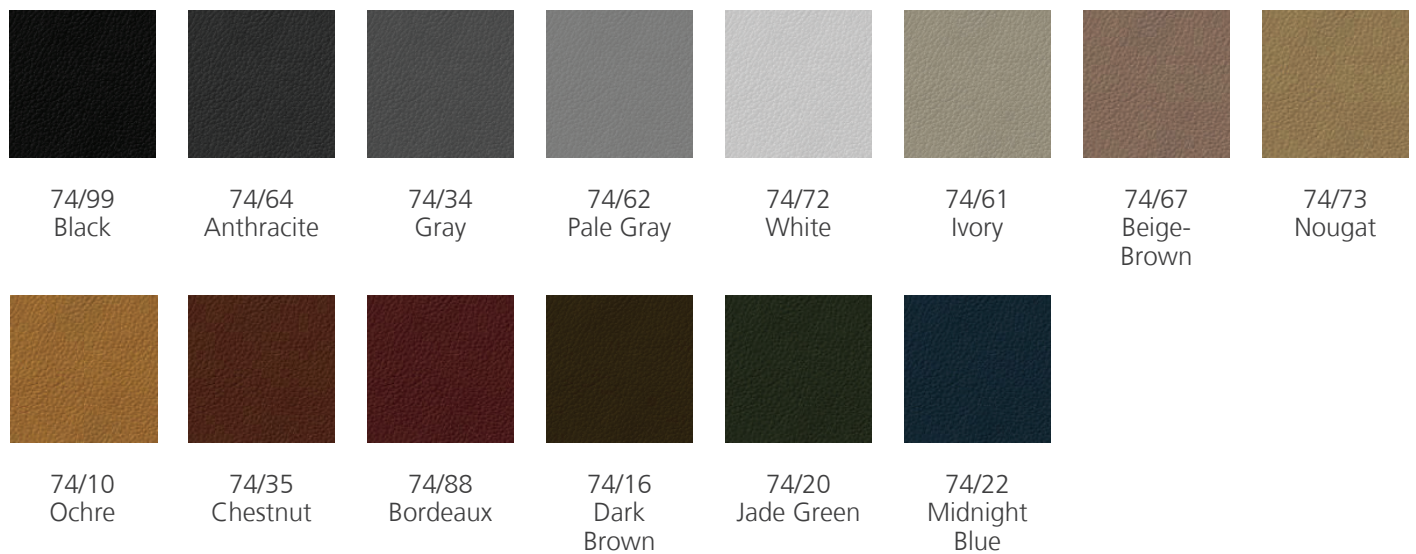

**Leather 87**

**Description** - Finest, pure aniline dyed cowhide that exhibits some natural characteristics or may develop patina over time.

**Test results** - Lightfastness: 3, BS EN ISO 105-B02 Method 2 Flame resistance: on request

**Cleaning** - Remove dirt or stains carefully with a slightly damp, absorbent cloth and immediately rub over surface with a dry woollen cloth.

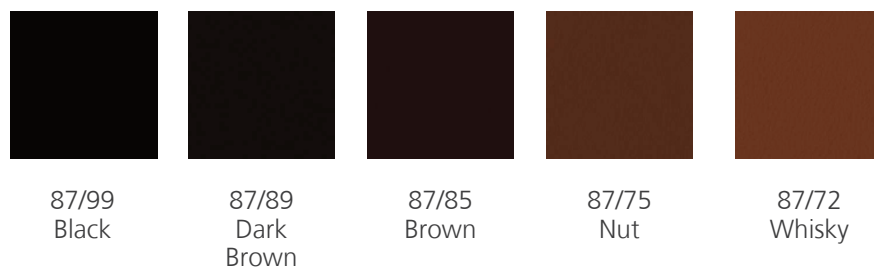

\* The digital sample colors might differ from the originals



Aula chairs and mAx tables

Finishes



## Mesh colors

### 230 range Mesh



Black Mesh  
in combination with black frame only



White Mesh  
in combination with white frame only



Gray Mesh  
in combination with gray frame only



Copper Mesh  
in combination with black frame only



Silver Mesh  
in combination with black frame only

Mesh colors

180 range Mesh



Black Mesh



Light gray Mesh



White Mesh

Modus Mesh



Black Mesh



Black Powder Coated Aluminum



White Powder Coated Aluminum



Silver Powder Coated Aluminum



Matte Polished Aluminum



Bright Chrome Aluminum



Cement gray  
RAL 7023



Gray-white  
RAL 9002



Signal white  
RAL 9003



Graphite black  
RAL 9011



Brown-green  
RAL 6008



Flame red  
RAL 3000



White



Gray



Black



Gray Beige



Blue Gray



Orange Red



White



Gray



Black



Gray Beige



Blue Gray



Orange Red



White



Gray



Black



Gray Beige



Blue Gray



# Standard Lead Times per Zone



## Terms and Conditions

**1. Parties.** “We” and related terms and “WILKHAHN” refer herein to WILKHAHN, Inc. (d/b/a “Wilkhahn”), a Delaware corporation; “you” and related terms and “Purchaser” herein refer to any person or entity purchasing or offering to purchase Goods from WILKHAHN. The goods and services delivered or to be delivered by WILKHAHN to Purchaser are herein referred to as the “Goods.”

**2. Acceptance.** The terms and conditions of sale and delivery herein set forth (the “Terms and Conditions”) shall constitute the sole and exclusive agreement between WILKHAHN and Purchaser with respect to any transaction between WILKHAHN and Purchaser. Mere issuance of Purchaser’s form containing different or additional provisions shall not constitute a specific objection. An order shall not be effective until WILKHAHN shall have accepted it in writing. WILKHAHN’s acceptance of Purchaser’s order shall not constitute an acceptance of printed provisions on any form supplied by Purchaser which are different from or additional to any term hereof, unless specifically accepted in writing by an authorized officer of WILKHAHN, and such different or additional provisions are hereby expressly rejected.

**3. Orders.** A contract shall not be established except upon our written confirmation of an order. We shall be entitled to assume (a) acceptance of these Terms and Conditions (b) any additional terms and conditions set forth in our acknowledgment of order and (c) confirmation of your order, upon acceptance of the delivered goods or your compliance with our request for payment in advance or you having a letter of credit issued for our benefit. Should Purchaser require amendments to be made to its order subsequent to our confirmation of the same, no such amendment shall be effective, unless we agree to such amendment in writing; we may, at our discretion, refuse to accept all or part of any such request.

**4. Suspension and Cancellation.** Upon doubt of the Purchaser’s financial solvency or creditworthiness, we shall be entitled to suspend performing our contractual obligations. If Purchaser does not provide adequate assurance and/or adequate security to support the payment of any outstanding order within the time specified by WILKHAHN, WILKHAHN may thereupon cancel any open order and, without limiting the generality of the foregoing, shall not be obligated to deliver any of the ordered Goods and shall be entitled promptly to be indemnified and held harmless by Purchaser from and against any losses, damages, liabilities, costs and expenses incurred and suffered by it in connection with the suspension and/or cancellation of any order, (including without limitation lost profits and costs incurred for the acquisition of primary materials necessary to commence manufacture and otherwise fill the order).

**5. Prices and Delivery.** Written price quotations issued by WILKHAHN expire thirty (30) days from the date of issuance and may be withdrawn by written notice at any time during this period, unless the relevant offer shall have been accepted in writing by Purchaser. Unless specified otherwise by WILKHAHN in writing, prices are (a) F.O.B. (as defined by New York law) WILKHAHN’s warehouse, if the origin of the shipment is in the United States of America, or (b) F.O.B. (Incoterms 2010) WILKHAHN’s factory, if the origin of the shipment is outside the United States of America. Upon Purchaser’s request, WILKHAHN will identify the point of origin. Whenever possible, WILKHAHN will ship in accordance with Purchaser’s instructions within the contiguous United States of America. If a carrier and/or a method of shipment and/or routing are not specified, WILKHAHN will exercise its professional judgment in selecting a carrier, the method of shipment and/or routing, as the case may be, in order to deliver the Goods to Purchaser’s address indicated by Purchaser (the “Purchaser’s Site”) within the contiguous United States only. Unless otherwise agreed in writing, WILKHAHN will charge for freight a percentage of the price, as referenced in the relevant price quotation and/ or invoice. WILKHAHN shall not be responsible for any other costs and expenses in connection with the transportation from the point of origin to the Purchaser’s Site, including without limitation, transport insurance and charges incurred at the point of destination such as any costs of storage, unpacking, assembly, installation or any other work, services or expenses performed or incurred at Purchaser’s Site. In any case, the risk of loss and damage shall pass over to Purchaser once the Goods have been put into the possession of the carrier at the point of origin.

**6. Time for Delivery.** Any delivery dates furnished by WILKHAHN to Purchaser are estimates only and do not bind WILKHAHN to ship or deliver the Goods on the dates indicated unless specifically so stated by WILKHAHN in writing to be binding. WILKHAHN reserves the right to make partial shipments and to submit separate invoices to Purchaser for each such partial shipment. If Purchaser defaults in its obligations in regard to any partial shipment, WILKHAHN may suspend any additional shipments unless and until Purchaser cures such default and shall have such other remedies set forth herein. Binding delivery dates are subject to change for any cause which interferes with WILKHAHN’s production, supply, transportation or installation of the Goods (whether or not caused or contributed to by WILKHAHN’s negligence or fault), including, but not limited to, any event of force majeure. If WILKHAHN fails to comply with designated, binding or other delivery dates, makes partial shipments, or fails to perform its obligations in accordance with any time limits, WILKHAHN shall not incur any liability whatsoever for any direct, indirect, consequential, incidental, special, exemplary or punitive damages (including claims for loss of profits or other claims) which may be incurred by Purchaser or any other person or entity. Title to the Goods sold hereunder shall pass from WILKHAHN to Purchaser at the time when the risk of loss and damages passes in accordance with the applicable shipping term as described in the last sentence of Section 5.

**7. Force Majeure.** In the event of delay due to war, riots, labor or industrial disputes, energy or other raw material shortages, transportation problems, accidents, administrative measures or disruptions in WILKHAHN’s or one his affiliates or direct or indirect supplier’s businesses or some other cause beyond WILKHAHN’s control, the time for any delivery shall be extended accordingly and WILKHAHN shall not incur any liability whatsoever for any direct, indirect, consequential, incidental, special, exemplary or punitive damages (including claims for loss of profits or Purchaser’s or any other person’s or entity’s claims arising out of or relating to changes in delivery dates, partial shipments or untimely performance) which may be incurred by Purchaser or any other person or entity. Upon the occurrence of a force majeure event, WILKHAHN may, at its sole discretion, elect, by a written notice to Purchaser, to cancel the order and determine not to ship some or all of the Goods.

**8. Storage.** Should Purchaser fail to accept Goods upon delivery by WILKHAHN on or within ten (10) business days of the delivery date set forth in the order acknowledgment or as otherwise agreed in writing, we shall be entitled to make arrangements for the storage of the Goods and be entitled to charge the Purchaser for the Goods as well as for storage costs plus a handling and administration charge of \$1,000.

**9. Taxes.** Except as otherwise provided by law, Purchaser shall be solely responsible to pay all income, sales, excise, or other taxes due in connection with any sale hereunder. If Purchaser claims an exemption from any tax, Purchaser shall submit the relevant exception certificate to WILKHAHN with the written order acknowledgment.

**10. Specifications.** The specifications contained in our order confirmation shall be authoritative in determining our obligations regarding the quality of Goods. Insofar as the order specifications make reference to specifications contained in brochures or other printed or other materials (e.g. on our website), such specifications shall be deemed merely to be examples, and shall not binding upon us. In the case of natural material such as wood or leather, Purchaser accepts that all specifications, representations or samples can only be understood to be exemplary depictions due to the natural variations of such materials.

## Terms and Conditions

**11. Inspection.** Purchaser shall diligently examine the delivered Goods and shall notify WILKHAHN of any non-conformance with any of the specifications without delay at the latest within one (1) business day of Purchaser's receipt of the goods.

**12. Limited Warranty.** WILKHAHN warrants that the Goods shall substantially conform to the design specifications established by WILKHAHN in regard to the Goods under normal use and service, in line with generally accepted industry standards and the relevant state of the art, unless otherwise agreed by WILKHAHN and Purchaser. If any failure to conform substantially to any specification is reported to WILKHAHN in writing within five (5) years after the date of receipt of the Goods by Purchaser and to the extent that any substantial non-conformance cannot be detected by a reasonable and customary inspection, such report shall be made within five (5) years after the receipt of the Goods by Purchaser. Purchaser will not be entitled to a warranty claim merely on the grounds of non-conformance of the Goods' optical characteristic; Purchaser must also demonstrate that the Goods' functionality was compromised. WILKHAHN, upon being satisfied of the existence of such non-conformity, shall correct the same, at its sole election, either by repairing the non-conforming Goods or by delivering to Purchaser replacement of such number or quantity of the Goods as shall have a non-conformity within a reasonable period of time (which may exceed sixty (60) days). Purchaser shall separate non-conforming Goods from conforming Goods, and Purchaser shall be deemed to have accepted the conforming Goods. Purchaser shall not repair or have an unauthorized third party repair any non-conformity without WILKHAHN's prior written consent. If WILKHAHN is unable or unwilling to correct such non-conformity by repairing or delivering replacement goods, whether due to the nature of such non-conformity, the use made by the Purchaser of the Goods, or for any other reason, WILKHAHN shall, at its sole election, reduce the purchase price accordingly or grant the Purchaser a credit against future purchases. WILKHAHN shall in no event be required to refund any part of the purchase price. The warranty set forth in this paragraph shall apply not only to the Goods but also to any replacement Goods. This warranty does not cover damage or defects caused by or resulting from (i) unauthorized repairs, alterations or modifications to the Goods, (ii) negligence, accident, abuse, misuse, improper, unsuitable or abnormal usage or storage of the Goods, (iii) failure to conform strictly to WILKHAHN's specifications and instructions in connection with the use, storage or repair of the Goods, (iv) defects due to specifications supplied by Purchaser, (v) exposure of the Goods to unreasonable temperatures or other environmental conditions, or (vi) storage and usage past specified product life. Ordinary wear and tear shall not be considered a defect in workmanship or materials. The foregoing shall be Purchaser's sole and exclusive remedies, and the liability of WILKHAHN hereunder is expressly limited to repair or replacement of nonconforming Goods or the grant of a credit, as the case may be.

WILKHAHN SHALL NOT BE LIABLE TO PURCHASER OR ANY OTHER PERSON FOR DAMAGES IN EXCESS OF THE PURCHASE PRICE PAID BY PURCHASER AND WILKHAHN SHALL NOT BE LIABLE TO PURCHASER OR ANY OTHER PERSONS, WHETHER BY WAY OF INDEMNIFICATION OR CONTRIBUTION OR OTHERWISE, FOR SPECIAL OR CONSEQUENTIAL DAMAGES, WHETHER ARISING FROM DEFECTIVE WORKMANSHIP OR MATERIALS OR DESIGN, BREACH OF WARRANTY, DELAYS IN DELIVERY OR FROM ANY OTHER CAUSE WHATSOEVER, INCLUDING THE NEGLIGENCE OF WILKHAHN OR ANY ENTITIES CONTROLLING, CONTROLLED BY OR UNDER COMMON CONTROL WITH WILKHAHN. THIS WARRANTY SHALL BE IN LIEU OF ALL OTHER WARRANTIES, AND THE WARRANTIES OR MERCHANTABILITY OR FITNESS FOR PURPOSE OR OTHERWISE, EXPRESS OR IMPLIED, ARE EXCLUDED.

In the event of delivery delays for which WILKHAHN shall have agreed to be liable, WILKHAHN shall not be liable in any event for more than any amount of liquidated damages expressly agreed by WILKHAHN in writing. Any claim by Purchaser shall be made in writing, shall describe all relevant facts in sufficient detail (including all relevant documents) and shall not be delivered to Purchaser later than thirty (30) days after the relevant event resulting in the alleged damage. No Goods shall be returned without WILKHAHN's prior written consent. Goods which WILKHAHN consents to have returned shall be shipped by Purchaser at Purchaser's risk and expense, freight prepaid, to WILKHAHN's manufacturing plant or such other location as WILKHAHN may designate. WILKHAHN's warranty obligation is limited to the original Purchaser of Goods. High wear parts such as fabrics and other covering materials, metal framed stacking chairs and wood veneers are not covered by this warranty. WILKHAHN does not warrant matching of color, grain or texture of wood or leather because of natural color variations which cannot be controlled. Damage incurred in transit from the point of origin to the Purchaser's Site or occasioned by accident, negligence, abuse or alteration is not included in this warranty. WILKHAHN does not warrant the appearance, behavior or durability of Purchaser's own material or Purchaser's own leather applied to WILKHAHN Goods. Upholstery materials are not warranted against fading or irregularity in register.

WILKHAHN will pass through other manufacturer's warranties where applicable and to the extent possible. WILKHAHN warranty applies only to WILKHAHN Goods. Warranty does not apply to attachments to WILKHAHN Goods. Any warranty expressed or implied is invalid when WILKHAHN components are used in conjunction with any components not manufactured or sold by WILKHAHN. Goods not installed or used in accordance with WILKHAHN installation and/or application guidelines are not included in this warranty. The warranty against defects only encompasses defects existing at the time of delivery and defects in Goods manufactured by us. The warranty does not cover material supplied by the Purchaser. We expressly point out that the surfaces of the goods are subject to wear and tear by reason of ordinary usage. We shall be entitled to charge the Purchaser for the costs incurred in examining the goods in the event of an unjustified claim of defects.

**13. Changes and Cancellation.** Orders may not be changed or cancelled, in whole or part, without prior written consent by WILKHAHN, which consent WILKHAHN may or may not grant at its sole discretion. Changes may effect delivery dates. WILKHAHN reserves its right to charge Purchaser for expenses incurred as a result of changes or any cancellation requested by Purchaser.

**14. Terms of Payment.** Unless otherwise agreed by WILKHAHN in writing, Purchaser shall make a non-refundable deposit equal to fifty percent (50%) of the total price, plus all fees, charges and expenses payable by Purchaser, including with respect to transportation and installation, by wire transfer in immediately available funds (the "Deposit") to WILKHAHN's following bank account:

HSBC Bank USA N.A.  
Acc# 04888 3085  
ABA# 02100 1088  
Swift Code# MRMDUS33

WILKHAHN shall not be required to commence any work with respect to any order until the full amount of the Deposit shall have been received by WILKHAHN. Purchaser acknowledges and agrees that the Goods are specially manufactured for Purchaser and that the Deposit shall be non-refundable in all cases. The remaining fifty percent (50%) of the purchase price and all remaining fees, charges and expenses relating to any order shall be paid by wire transfer in immediately available funds to WILKHAHN's bank account as herein above designated upon delivery of the invoice to Purchaser. Invoices will ordinarily be issued to Purchaser upon the shipment of the Good or, if shipped from outside of the United States of America, within five (5) days after entering the United States of America. Purchaser is not entitled to make any deductions or set-offs from payments due to WILKHAHN. Upon default on the part of Purchaser to pay on time, Purchaser shall pay to WILKHAHN, subject to any further damages we may incur, a late charge of \$1,000 and interest on all outstanding sums at the rate of 5% above the prime lending rate (or, if lower, the highest legally permissible rate). All payments should be effected such that payment is credited on the date that payment shall be due. All banking and other charges in connection with any payment shall be paid by Purchaser.

## Terms and Conditions

**15. Copyrights and Designs.** We shall retain the ownership and copyright of all documentation delivered or shared with Purchaser, including but not limited to all illustrations, drawings, sketches and collections, which are to be promptly returned to us upon request and all copies which cannot be returned shall be destroyed and, upon request, Purchaser shall certify such destruction. We shall also have all rights relating to forms, prototypes and technical solutions relating to the Goods. Purchaser shall not be entitled to make or have made Goods by reverse engineering or otherwise using our Goods, or parts thereof, as a prototype or model. This prohibition includes the manufacture of such reverse engineered goods, whether independently or with or through an agent or a third party, as well as the direct or indirect participation in the distribution of such reverse engineered goods. ANY VIOLATION OF ANY PART OF THIS SECTION SHALL BE A WILFUL VIOLATION OF COPYRIGHT LAWS which may entitle Wilkhahn to collect statutory and other damages as well expenses, including attorneys' fees, from Purchaser.

**16. Indemnity.** Purchaser shall indemnify, defend, reimburse and hold WILKHANH harmless from and against all costs, losses, liabilities, damages and expenses (including attorneys' fees and expenses) (collectively, a "Loss" or "Losses"), arising out of or resulting from (i) any the breach by Purchaser of any of its obligations hereunder or (ii) any actual or threatened claim, demand, action or proceeding initiated by any third party arising out of or resulting from an act or omission of Purchaser.

**17. Dispute Resolution.** These Terms and Conditions shall be governed by the laws of the State of New York, without reference to its conflicts of law principles; provided, however, that the parties hereto expressly exclude the application of the 1980 United Nations Convention on Contracts for the International Sales of Goods. Each of WILKHANH and Purchaser hereby irrevocably consents that (i) any action, suit or other legal proceeding arising out of or relating to any transaction hereunder may be brought in any federal or state court within the County of New York, State of New York, (ii) consents to the jurisdiction of such courts in any such suit, action or proceeding, waives any objection which it may have to the laying of venue of such suit, action or legal proceeding in any such court and any claim that any such suit, action or proceeding has been brought in an inconvenient forum, (iii) service of process may be accomplished using any of the methods described in Section 20 hereof, (iv) any judgment may be enforced in any other jurisdiction by suit on the judgment or in any other manner provided by law and (v) nothing in this Section 18 shall affect the right of WILKHANH to serve legal process in any other manner permitted by law or affect the right of WILKHANH to bring any suit, action or proceeding against Purchaser or its property in any court of any jurisdiction. EACH OF WILKHANH AND PURCHASER HEREBY IRREVOCABLY WAIVES, TO THE FULLEST EXTENT PERMITTED BY LAW, ALL RIGHTS TO TRIAL BY JURY IN ANY ACTION, PROCEEDING, OR COUNTERCLAIM (WHETHER BASED UPON CONTRACT, TORT OR OTHERWISE) ARISING OUT OF OR RELATING TO ANY TRANSACTION HEREUNDER. In connection with any controversy hereunder, each party shall be responsible for its attorneys' fees and disbursements and all court and related costs and expenses, except that if WILKHANH shall be the prevailing party in any such controversy WILKHANH shall be entitled to reimbursement of attorneys' fees and disbursements and all court and related costs and expenses from Purchaser.

**18. Confidentiality.** Purchaser agrees that all specifications, data and other technical, financial or other non-public information furnished by WILKHANH to Purchaser constitute the property of WILKHANH, are furnished solely for the purpose of WILKHANH's performance hereunder, shall be held in strict confidence by Purchaser and may not be copied, made accessible to third parties or used without WILKHANH's prior written consent. Purchaser shall promptly return all such information and all copies thereof (in whatever format, including electronic, digital, hard copy or other medium) to WILKHANH upon WILKHANH's request or, if such delivery is impossible, destroy such information and certify such destruction to WILKHANH in writing. Such request may be made at any time prior to or after delivery of any Goods. The obligations of Purchaser hereinabove set forth shall survive cancellation or completion of any order.

**19. Notices.** Any notices given hereunder shall be in writing and shall be deemed given: (i) upon delivery, if by hand; or (ii) after one (1) business day, if sent between destinations within the continental United States, or two (2) business days, if sent between the continental United States and any other jurisdiction, if sent by air courier (e.g., UPS, DHL, Airborne or Fedex). All notices to WILKHANH hereunder shall be given to Wilkhahn Forum New York, 601 West 26th Street, Suite 820, New York, NY 10001 and the sales representative of WILKHANH responsible for Purchaser's account, and all notices to Purchaser shall be given to such address as indicated in the relevant order acknowledgment, or at such other address (or to such other person's attention), as shall be specified by like notice by the relevant party.

**20. Definition.** Purchaser acknowledges and agrees that (i) it shall be a "merchant" within the meaning of the Uniform Commercial Code, as in effect from time to time in the State of New York (the "UCC") and (ii) any transaction between WILKHANH and Purchaser shall be deemed to be "between merchants" within the meaning of the UCC. Purchaser further acknowledges and agrees that it has the skill and knowledge of a merchant in the Goods, particularly in that it has a legal and/or purchasing department, business personnel or other agents who are familiar with the business practices involved in that transaction contemplated hereby or otherwise equipped to handle such a transaction.

**21. Miscellaneous.** The invalidity or unenforceability of any one or more of the terms and conditions of this form shall not affect the validity or enforceability of the remaining provisions hereof. The failure or omission of WILKHANH to insist upon strict performance of any term or condition hereof or to exercise any right hereunder shall not be deemed to be a modification of any term or condition hereof or a waiver or relinquishment of the future performance of any such term or condition, nor shall such failure or omission constitute a waiver of the right of such party to insist upon future performance by the other party of any such term or condition. This document may be amended from time to time by WILKHANH upon notice to Purchaser, and any such amended version shall supersede any and all prior versions thereof.



Wilkhahn employee in the 1950's



Intra



Insit

[www.wilkhahn.us](http://www.wilkhahn.us)

# Wilkhahn

United States  
Wilkhahn Forum New York  
Wilkhahn Inc.  
601 West 26th Street  
Suite 820  
New York, NY 10001  
Tel. + 1 212 229 9455  
Fax + 1 212 229 4772  
[sales@wilkhahn.com](mailto:sales@wilkhahn.com)  
[www.wilkhahn.com/en-us](http://www.wilkhahn.com/en-us)

Wilkhahn Forum Chicago  
Wilkhahn Inc.  
Tree Studios  
4 East Ohio Street, Studio 35  
Chicago, IL 60611  
Tel. +1 312 896 3446  
Fax +1 312 762 9362  
[sales@wilkhahn.com](mailto:sales@wilkhahn.com)  
[www.wilkhahn.com/en-us](http://www.wilkhahn.com/en-us)