

Tegan

Recessed square prismatic luminaire

Whitecroft
lighting

120+
LL/CW



IP 20
44

LED

ECA



Optics

Tegan Office+

- Specialised acrylic Hexaprism optic with prisms facing down for optimum glare control and an LG7 compliant space
- Inner micro-Hexaprism square with an opal outline for aesthetic interest and differentiation
- Output:
 - 4100 lumens, 41W

Tegan Office

- Specialised acrylic Hexaprism optic with prisms facing down for optimum glare control and an LG7 compliant space
- Output:
 - 3100 lumens, 29W
 - 4100 lumens, 41W

Tegan Area

- Opalised diffuser
- Outputs:
 - 1950 lumens, 16W
 - 4100 lumens, 35W
 - 6120 lumens, 56W
- Emergency Output (BLF):
 - Office - 280 Lumens
 - Office+ - 280 Lumens
 - Area - 280 Lumens
- Available with 3000K and 4000K LED

Body



- Steel body finished white
- Shallow body profile
- IP44 protection from front, IP20 from behind
- 600 x 600mm square
- RAL Colour: White RAL9003.
- For lay in ceiling integration on T15 and T25 ceilings
- Choice of integral emergency options; 3hr or COMEPS

Order codes

Tegan Office

				B50		
Tegan Office (4000K)	Fixed Output	3hr Emergency	LL/CW	L70	L80	L90
3100 lumens, 29W	TEHDH14K	TEHDH14KEM	 107	>100k	>100k	90k
4100 lumens, 41W	TEHDH24K	TEHDH24KEM	102	>100k	>100k	76k

Tegan Area

				B50		
Tegan Area (4000K)	Fixed Output	3hr Emergency	LL/CW	L70	L80	L90
1950 lumens, 16W	TEPDH14K	TEPDH14KEM	 121	>100k	>100k	92k
4100 lumens, 35W	TEPDH24K	TEPDH24KEM	 117	>100k	>100k	89k
6120 lumens, 56W	TEPDH34K	TEPDH34KEM	 109	>100k	>100k	63k

Tegan Office+

				B50		
Tegan Office+ (4000K)	Fixed Output	3hr Emergency	LL/CW	L70	L80	L90
4100 lumens, 41W	TESDH24K	TESDH24KEM	100	>100k	>100k	76k

Options

COMEPS Add suffix /EP i.e TEHDH14K/EP

DALI DIMMING Replace H with Y i.e TEHDY14K

* COMEPS can be wired for Easytest functionality if required.
For 3000K colour temperature, please contact Whitecroft.

Accessories

Plasterboard Installation Frame CSDPBF

LED Performance

Colour Temp	RA (CRI)	Colour consistency
4000K	>80	MacAdam 3 SDCM

Dimensions

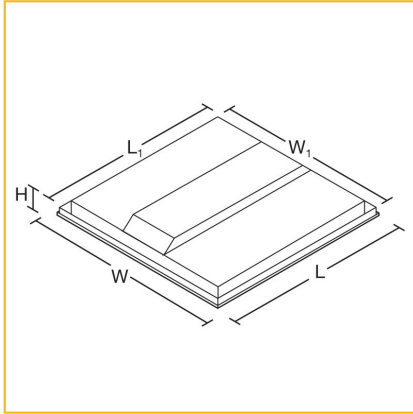

Version	L	L1	W	W1	H	KG	KG(EM)	Cut Aperture
Tegan	595	545	595	545	103	4.5	6	
Plasterboard Frame	660		660		95	6.5	7.5	625 x 625 -3 +3

Photometric Performance

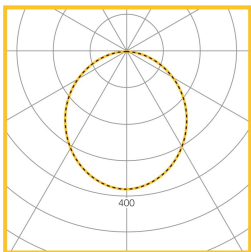

Prismatic Diffuser
56W LED
LOR = 100.0%
SHR MAX = 1.55

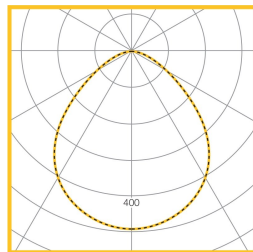

Hexaprism Optic
41W LED
LOR = 100.0%
SHR MAX = 1.58

Performance Guide

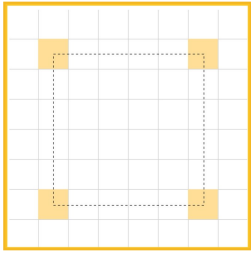

Lamps	56W LED
Illuminance	587 lux
Spacing	3.0m x 3.0m
Maintenance	0.8
Reflectance	70/50/20
Ceiling Height	2.8m
Working plane	0.8m

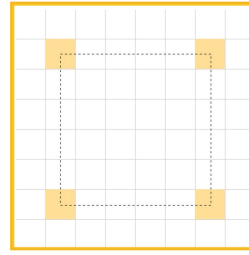

Lamps	41W LED
Illuminance	407 lux
Spacing	3.0m x 3.0m
Maintenance	0.8
Reflectance	70/50/20
Ceiling Height	2.8m
Working plane	0.8m

To Specify

Recessed LED 600 x 600mm luminaire with slim line steel body and Prismatic diffuser for general, non VDT areas or Hexaprism optic for LG7 office compliant schemes. Suitable for lay in exposed T ceilings – as Whitecroft Lighting TEGAN.
