

# Levanter

LED post top luminaire for outdoor applications

Whitecroft  
lighting

100+  
LL/CW

IK09

IP66

LED

ECA

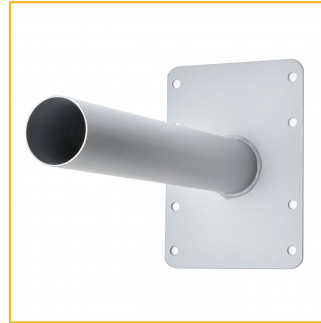

Simple Wall Bracket



Silver Finish



Heavy Duty Wall Bracket

## Optics







- Output range from 2800 to 14007 lumens
- 34 to 167W
- 5 distribution patterns to suit a wide range of applications
- Zero light pollution
- 4000K and 3000K LED options

## Body

- IP66, IK09 rated protection
- Die cast aluminium body
- Powder coated for corrosion and saline environment resistance
- For outdoor applications within 3km of the coast, an enhanced paint finish can be offered on request
- Finished in graphite grey or silver/grey
- 46 to 76mm post top or side entry spigot
- Adjustable tilt angle between 0 to 20° in 5° increments
- Supplied with IP67 rated plug and socket
- Automatic temperature regulation and voltage surge protection
- Safety cut-off switch for ease of servicing
- Electrical Class 2 rated
- Suitable for ambient temperatures between -30°C to +40°C
- Heavy duty adjustable or simple fixed wall mounting brackets available
- Heavy duty bracket maximum weight 13kg
- Simple wall bracket maximum weight 8.2kg
- Optional dual power for factory pre-set night-time dimming to 50% for 7 hours duration
- Integral photocell option with 20 lux on/off switching
- Fixed output as standard, DALI optional
- Graphite grey RAL 7024
- Silver/grey RAL 9007

## Order codes

### Version

|                   |                               |                   | B50   |       |       |     |
|-------------------|-------------------------------|-------------------|---|-------|-------|-----|
| 4000K             | Code - Fixed Output, Graphite | Distribution      | LL/CW   | L70   | L80   | L90 |
| 4700 lumen, 42W   | LEVH14KG                      | Road Optics       |  112 | >100k | >100k | 70k |
| 9400 lumen, 84W   | LEVH24KG                      | Road Optics       |  112 | >100k | >100k | 70k |
| 14007 lumen, 126W | LEVH34KG                      | Road Optics       |  111 | >100k | >100k | 70k |
| 4669 lumen, 42W   | LEVH14KGW                     | Wide Road         |  111 | >100k | >100k | 70k |
| 9337 lumen, 84W   | LEVH24KGW                     | Wide Road         |  111 | >100k | >100k | 70k |
| 13980 lumen, 126W | LEVH34KGW                     | Wide Road         |  111 | >100k | >100k | 70k |
| 3045 lumen, 35W   | LEVH14KGA                     | Asymmetric 60°    | 87  | >100k | >100k | 70k |
| 6130 lumen, 69W   | LEVH24KGA                     | Asymmetric 60°    | 89  | >100k | >100k | 70k |
| 9395 lumen, 104W  | LEVH34KGA                     | Asymmetric 60°    | 90  | >100k | >100k | 70k |
| 3011 lumen, 34W   | LEVH14KGN                     | Narrow Cycle Path | 88  | >100k | >100k | 70k |
| 6015 lumen, 68W   | LEVH24KGN                     | Narrow Cycle Path | 88  | >100k | >100k | 70k |
| 2862 lumen, 35W   | LEVH14KGF                     | Wide Flood        | 82  | >100k | >100k | 70k |
| 5725 lumen, 69W   | LEVH24KGF                     | Wide Flood        | 83  | >100k | >100k | 70k |
| 8587 lumen, 104W  | LEVH34KGF                     | Wide Flood        | 83  | >100k | >100k | 70k |

Lifetime figures to L\*\*B10

## Accessories

|  |              |
|--|--------------|
| Heavy duty wall mounting bracket (black) | SIRBKT       |
| Simple wall mounting bracket (silver)    | DS/997708-00 |

## Options

|                      |                      |                  |
|----------------------|----------------------|------------------|
| INTEGRAL PHOTOCELL** | Add suffix '/PC'     | i.e. LEVH14KG/PC |
| SILVER/GREY FINISH   | Change 'G' to 'S'    | i.e. LEVH14KS    |
| DALI DIMMING*        | Replace 'H' with 'Y' | i.e. LEVY14KG    |
| DUAL POWER           | On request           |                  |
| 3000K                | Replace 4K with 3K   | i.e. LEVH13KG    |

\* Dali Dimming not available with integral photocell

\*\* Luminaire is IP65 with fitted photocell

A wide range of columns and attachments is available. See columns and attachments web pages for details

## LED Performance

| Colour Temp | RA (CRI) | Colour consistency |
|-------------|----------|--------------------|
| 4000K       | >70      | MacAdam 3 SDCM     |

## Dimensions

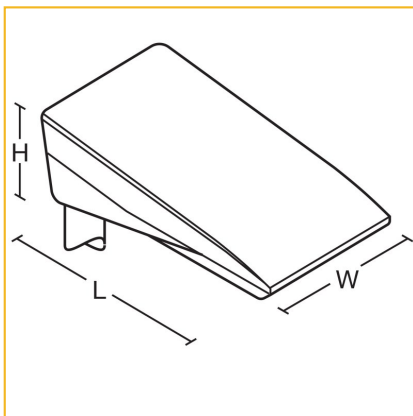

| L   | W   | H   | KG  | Windage M <sup>2</sup> |
|-----|-----|-----|-----|------------------------|
| 603 | 300 | 180 | 7.2 | 0.11                   |

# Photometric Performance

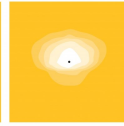
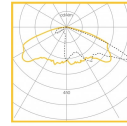
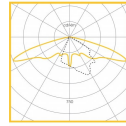
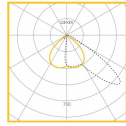
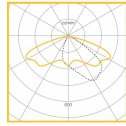
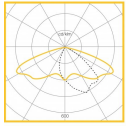

Road Lighting  
9400 lumen, 84W  
LOR = 100%

Wide Road  
Lighting 9337  
lumen, 84W  
LOR = 100%

Asymmetric  
Forward 9395  
lumen, 104W  
LOR = 100%

Narrow Cycle  
Paths 6000  
lumen, 69W  
LOR = 100%

Wide Flood 8587  
lumen, 104W  
LOR = 100%

## To Specify

IP66 LED post top lantern with die cast aluminium body and polyester powder coated finish. A choice of distribution patterns and outputs to suit a range of applications, with zero upward light. Electronic control gear and high quality LEDs – as Whitecroft Lighting LEVANTER.