

# Levanter 2

High output LED post top luminaire for outdoor applications

Whitecroft  
lighting

100+  
LL/CW

IK09

IP66

LED

ECA



Heavy Duty Wall Bracket

## Optics







- Output range from 11,450 to 29,760 lumens
- 136 to 255W
- 4 distribution patterns to suite a wide range of applications
- Zero light pollution
- 4000K and 3000K LED options

## Body

- IP66, IK09 rated protection
- Die cast aluminium body
- Powder coated for corrosion and saline environment resistance
- For outdoor applications within 3km of the coast, an enhanced paint finish can be offered on request
- Finished in graphite grey or silver/grey
- 46 to 76mm post top or side entry spigot
- Adjustable tilt angle between 0 to 20° in 5° increments
- Supplied with IP67 rated plug and socket
- Automatic temperature regulation and voltage surge protection
- Safety cut-off switch for ease of servicing
- Electrical Class 2 rated
- Suitable for ambient temperature between -30°C to +40°C
- Heavy duty wall mounting bracket available, maximum weight 13kg
- Optional dual power for factory pre-set night time dimming to 50% for 7 hours duration
- Integral photocell option with 20 lux on/off switching
- Fixed output as standard, DALI optional
- Graphite grey RAL 7024
- Silver/grey RAL 9007

## Order codes

### Order Codes

4000K LED	Code - Fixed Output, Graphite	Distribution	LL/CW	L80
19840 lumen, 170W	LEV2H44KG	Road Optics	 117	100k
24800 lumen, 212W	LEV2H54KG	Road Optics	 117	100k
29760 lumen, 255W	LEV2H64KG	Road Optics	 117	100k
19707 lumen, 170W	LEV2H44KGW	Wide Road	 116	100k
24633 lumen, 212W	LEV2H54KGW	Wide Road	 116	100k
29560 lumen, 255W	LEV2H64KGW	Wide Road	 116	100k
12260 lumen, 136W	LEV2H44KGA	Asymmetric 60°	90	100k
15325 lumen, 170W	LEV2H54KGA	Asymmetric 60°	90	100k
18390 lumen, 204W	LEV2H64KGA	Asymmetric 60°	90	100k
11450 lumen, 136W	LEV2H44KGF	Wide Flood	84	100k
14312 lumen, 170W	LEV2H54KGF	Wide Flood	84	100k
17175 lumen, 204W	LEV2H64KGF	Wide Flood	84	100k

### Accessories

Heavy duty wall mounting bracket (black)      SIRBKT

## Options

INTEGRAL PHOTOCELL**	Add Suffix /PC	i.e. LEV2H44KG/PC
SILVER/GREY FINISH	Change 'G' to 'S'	i.e. LEVH44KS
DALI DIMMING*	Change 'H' to 'Y'	i.e. LEV2Y44KG
DUAL POWER	On request	
3000K LED	Change 4K to 3K	i.e. LEV2H43KG

\* Dali Dimming not available with integral photocell

\*\* Luminaire is IP65 with fitted photocell

A wide range of columns and attachments is available. See separate columns and attachments web pages for details

## LED Performance

Colour Temp	RA (CRI)	Colour consistency
4000k	>70	MacAdam 3 SDCM

## Dimensions

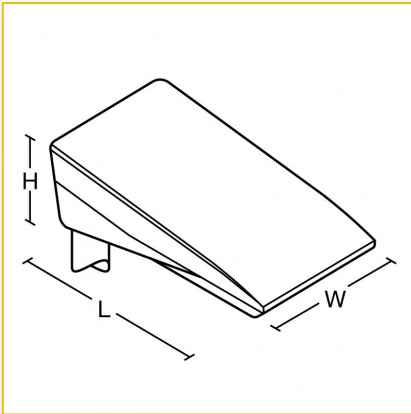

L	W	H	KG	Windage M <sup>2</sup>
803	330	198	12.0	0.16

# Photometric Performance

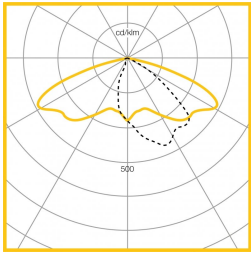

Road Optic |  
19,840 lumen |  
170W  
LOR = 100%

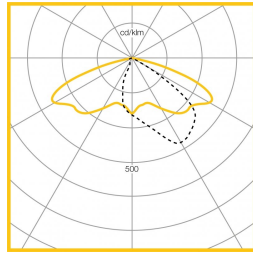

Wide Road |  
19,709 lumen |  
170W  
LOR = 100%

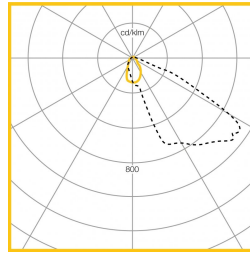

Asymmetric  
Forward | 15,325  
lumen | 170W  
LOR = 100%

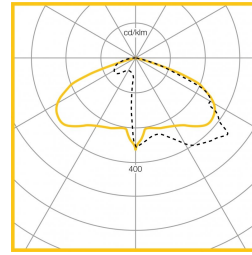

Wide Flood |  
14,312 lumen |  
170W  
LOR = 100%

## To Specify

IP66 LED post top lantern with die cast aluminium body and polyester powder coated finish. A choice of distribution patterns and outputs to suit a range of applications, with zero upward light. Electronic control gear and high quality LEDs – as Whitecroft Lighting LEVANTER 2.