

Intral

Integrated Lighting Trunking System, designed for quick installation and energy efficiency

Whitecroft
lighting

140+
LL/CW



IK07

IP40

IP54

IP65

LED



Intral - Lens Luminaire



Intral - Diffuser Luminaire



Intral - Lens Luminaire
Narrow

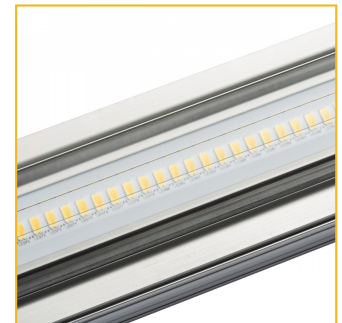

Intral - Diffuser Luminaire
Narrow

Overview

Intral is a fully integrated lighting trunking system with extruded aluminium profile, highly efficient luminaires, pre-wired internal cables and plug-in connectors. Flexible luminaire positioning and the ability to fine-tune light output result in optimum design solutions for most Industrial projects.

There is no need to fit luminaires into the trunking on site as each section of the Intral system is delivered pre-assembled and labelled with project specific codes for a quick and easy installation. Minimal packaging ensures a low environmental impact and reduced time in waste removal.

Intral uses high quality components for long life and maximum energy efficiency. Aluminium profiles ensure rigid light-lines and produce lower internal temperatures than steel systems. This form of thermal management lengthens the life expectancy of wiring, drivers and other components therefore minimising failures caused by over-heating.

Optics









- Lens or diffuser optics
- Wide, medium and narrow (rack) distribution patterns
- Diffuser version - PMMA material as standard, polycarbonate on request
- Lens version - PMMA
- Long life 100,000 hours to L80B50
- 4000K Ra80 LEDs

Body

- Quick and simple to install, typically half the time of other similar systems
- Delivered pre-assembled and labelled, ready to install
- High efficacy luminaires, up to 180 ll/cw
- Robust, high quality construction with long life components
- Allows flexibility for future use
- Extruded aluminium trunking profile
- 60mm wide trunking sections, supplied in lengths to suit project
- Pre-wired 7 core internal conductors with plug and sockets as standard
- 10 or 13 core versions available
- Optional trunking profile with additional cable channels on top for other services
- Integrated standalone lighting controls available to control groups of luminaires
- Presence and daylight sensing for maximum energy savings
- Detection zones to cover narrow areas (racking aisles) and open areas
- IP40 as standard when assembled
- IP54 and IP65 options available
- Suitable for ambient temperatures -25 to +35°C (integral emergency +5 to +25°C)
- High temperature to +55°C on request







Order codes

Design Files - Diffuser

Description	Fixed Output	LL/CW	L80 B50
Diffuser, Wide, 8016 lumen, 53W	LTDH1514KWO	 151	>100k
Diffuser, Wide, 11850 lumen, 79W	LTDH1524KWO	 150	>100k
Diffuser, Wide, 17000 lumen, 117W	LTDH1534KWO	 145	>100k
Diffuser, Medium, 8006 lumen, 56W	LTDH1514KM	 143	>100k
Diffuser, Medium, 10000 lumen, 73W	LTDH1524KM	 137	>100k
Diffuser, Medium, 17250 lumen, 115W	LTDH1534KM	 150	>100k
Diffuser, Narrow, 8016 lumen, 53W	LTDH1514KN	 151	>100k
Diffuser, Narrow, 10211 lumen, 71W	LTDH1524KN	 143	>100k
Diffuser, Narrow, 17000 lumen, 112W	LTDH1534KN	 151	>100k

Intral is a project specific system, the codes shown are to assist with lighting design. Please contact Whitecroft for project design and pricing support.

Design Files - Lens

Description	Fixed Output	LL/CW	L80 B50
Lens, Wide, 8250 lumen, 47W	LTLH1514KW	 175	>100k
Lens, Wide, 14008 lumen, 88W	LTLH1524KW	 159	>100k
Lens, Medium, 8250 lumen, 47W	LTLH1514KM	 175	>100k
Lens, Medium, 14008 lumen, 88W	LTLH1524KM	 159	>100k
Lens, Narrow, 8250 lumen, 47W	LTLH1514KN	 175	>100k
Lens, Narrow, 14008 lumen, 88W	LTLH1524KN	 159	>100k

Intral is a project specific system, the codes shown are to assist with lighting design. Please contact Whitecroft for project design and pricing support.

LED Performance

Colour Temp	RA (CRI)	Life expectancy	Colour consistency
4000K	Ra>80	L80(100,000hrs)	MacAdam 3 SDCM

Dimensions

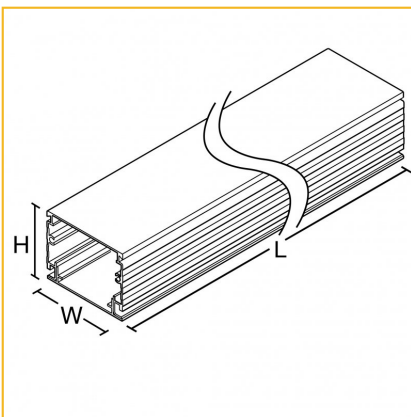

VERSION	L	W	H	KG	KG(EM)
per 1.53	1530	60	61.3	5.9	6.9
Power supply	150	60	55	0.5	-

Intral is a project based solution, supplied fully assembled in an optimum length of 4.59m. Weights shown above are the maximum for the complete system, per 1.53m. Exact details may change subject to project requirements.

Photometric Performance

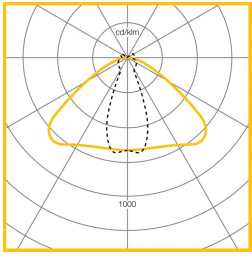

Intral Diffuser
Luminaire -
Narrow

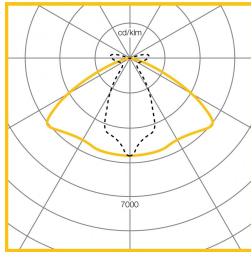

Intral Diffuser
Luminaire -
Medium

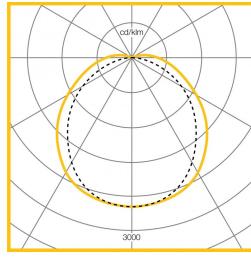

Intral Diffuser
Luminaire - Wide

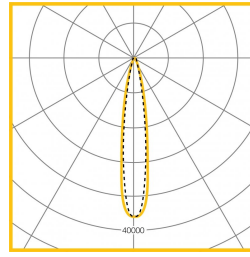

Intral Lens
Luminaire -
Narrow

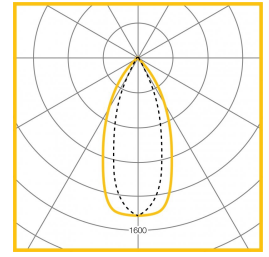

Intral Lens
Luminaire -
Medium

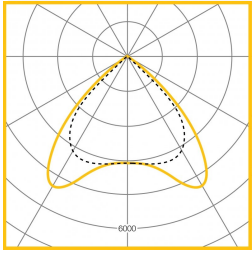

Intral Lens
Luminaire - Wide

Lighting Controls

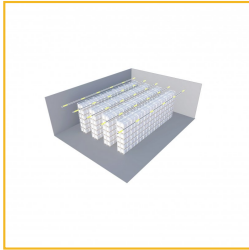
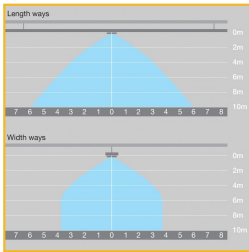

Detection Zone Open Area

Warehouse High Racking
11,000 lm, Narrow Beam Lens

Illuminance 200 Lux
Horizontal

Spacing 6.12m

Maintenance 0.8

Reflectance 50, 30, 10%

Ceiling Height 13m

Working plane 0m

Suspension 1m

UGR 21

Uniformity 0.56

Width 2.4m

Manufacturing Open Area
14,000 lm, Wide Beam Lens

Illuminance 500 Lux

Spacing 5.2m x 3.06m
(in length)

Maintenance 0.8

Reflectance 50, 30, 10%

Ceiling Height 7m

Working plane 1m

Suspension 1m

UGR 19

Uniformity 0.67

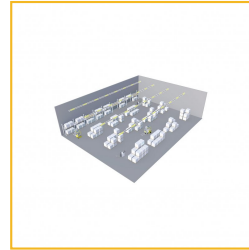
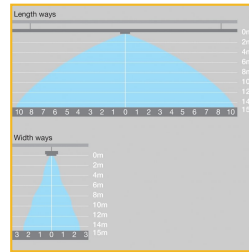
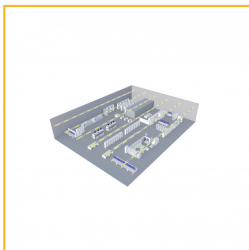

Detection Zone Narrow Area

Warehouse Open Area
11,250 lm, Medium Beam Lens

Illuminance 300 Lux

Spacing 6.5m x 4.59m
(in length)

Maintenance 0.8

Reflectance 50, 30, 10%

Ceiling Height 10m

Working plane 0m

Suspension 1m

UGR 19

Uniformity 0.67

To Specify

Fully integrated lighting trunking system with extruded aluminium profile and highly efficient luminaires with efficacy up to 180 ll/cw. Pre-wired 7, 10 or 13 core 2.5mm² cables and plug-in connectors, enabling up to 3 live circuits, emergency central battery, emergency test and central lighting control. Robust, high quality components to ensure a long life and maximum performance. Suitable for use in ambient temperatures from -25°C up to 35°C as standard and options up to 55°C. Factory assembled system delivered ready to install, with minimal packaging, for a quick and easy installation – as Whitecroft Lighting INTRAL.

Application images

