



Full Hexaprism



Non Air Handling

Optics

- Integral Definable Light Output (DLO) functionality that pre-programs a specified light output for energy saving and customisation
- Three optic configurations:
 - Central Hexaprism for feature aesthetic and visual differentiation
 - Full Hexaprism for optimum uniformity and glare control
 - Quadraprism for all round glare control
- Light Outputs:
 - Central Hexaprism - 3500 lumens
 - Full Hexaprism - 3000 or 4000 lumens
 - Quadraprism - 3000 or 4000 lumens
- Emergency Output (BLF):
 - Central Hexaprism - 300 Lumens
 - Full Hexaprism - 200 Lumens
 - Quadraprism - 200 Lumens
- All outputs are less than 3000 cd/m² at 65° elevation
- Available with 3000K and 4000K LED
- Full and Central Hexaprism optics have E-light LED as standard for increased luminous efficacy (ll/cw) and reduced through life costs

Body

- Fabricated steel body with extruded aluminium frame finished white
- RAL Colour: White RAL9010.
- IP40
- Optional air handling facility at 40 litres per second
- DALI as standard
- Integral COMECS emergency available
- Suitable to replace an SAS330 tile with gasket (1194mm x 297mm), gasket available from ceiling manufacturer

Note: Central Hexaprism luminaires are supplied with GST 18/6 black/blue panel mount plug and socket. For alternative configurations including Command Fast Link, consult Whitecroft Technical Desk.

Major Project Solutions



This product has been designed for use in major projects and as such is subject to minimum order quantities. For more information please consult your local Sales Engineer

Order codes



Central Hexaprism

			B50			
Central Hexaprism (4000K)	DALI	LL/CW	L70	L80	L90	
3500lm (23W) - e-light	CLCEY3/SRF1	 153	>100k	>100k	51k	

Full Hexaprism

			B50			
Full Hexaprism (4000K)	DALI	LL/CW	L70	L80	L90	
3000lm (24W) - e-light	CLFEY3/SRF1	 126	>100k	>100k	51k	
4000lm (32W) - e-light	CLFEY5/SRF1	 125	>100k	>100k	51k	

Quadraprism

			B50			
Quadraprism (4000K)	DALI	LL/CW	L70	L80	L90	
3000lm (26W)	CLQY3/SRF1	 114	>100k	>100k	51k	
4000lm (36W)	CLQY5/SRF1	 111	>100k	>100k	51k	

Options

AIR HANDLING	Add A after Y	i.e CLCEYA1/SRF1
COMECS	Add /EP before /SRF1	i.e CLCEY1/EP/SRF1

For 3000K colour temperature, please contact Whitecroft.

Accessories

Plasterboard Frame	CLFPBF/SRF1
--------------------	-------------

LED Performance

Colour Temp	RA (CRI)	Colour consistency
4000K	>80	MacAdam 3 SDCM

Dimensions

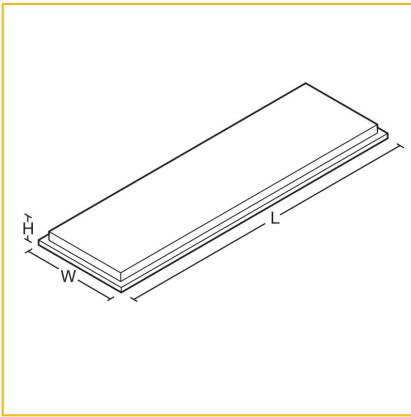

VERSION	L	W	W1	H	H1	KG	KG(EM)	Cut Aperture
Central Hexaprism	1194	297		60		5	5.5	
Full Hexaprism	1194	297		60	88	5.1	6.0	
Quadraprism	1194	297		60	88	5.1	6.0	
Plasterboard Frame	1260	360	101			3.0		1240 x 332

Photometric Performance

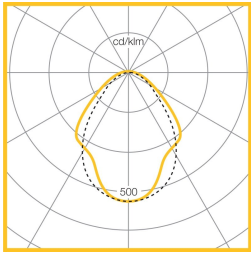

Central Hexaprism
23W LED 3500
Lumen
LOR = 100.0%
SHR MAX = 1.38

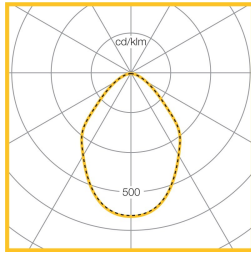

Full Hexaprism
32W LED 4000
Lumen
LOR = 100.0%
SHR MAX = 1.36

Performance Guide

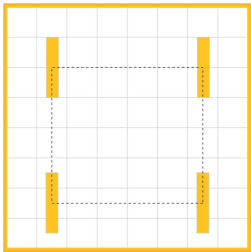

Lamps	32W LED
Illuminance	443 lux
Spacing	2.7m x 3.0m
Maintenance	0.8
Reflectance	70/50/20
Ceiling Height	2.7m
Working plane	0.75m

To Specify

Recessed linear tile replacement 1200x300mm LED luminaire with optional air return facility. Three prism optic configurations; Central feature Hexaprism for aesthetic differentiation, Full Hexaprism for optimum uniformity or Quadraprism for all round glare control. Integral DLO functionality for specified light outputs – as Whitecroft Lighting CITYLINE.