

# Broadsword

Linear suspended standalone or continuous luminaire

Whitecroft  
lighting

120+  
LL/CW



IP20

LED

ECA



Continuous



Uplighting Element

## Optics

Optic options:

- Advanced Hexaprism for optimum glare control and diffusion of light
  - 3400 lumens (32W)
  - 4800 lumens (47W)
- Quadraprism optic provides all round glare control
  - 3400 lumens (31W)
  - 4200 lumens (37W)
  - 6300 lumens (51W)
- Emergency Output (BLF):
  - All variants - 459 Lumens
- Available with 3000K and 4000K LED
- Downlight/uplight ratio is 75/25 except the 6300 version which is 50/50

## Body

- Slim depth sheet steel construction with no visible joints on the front face of the luminaire
- Simple geometric form
- Twin adjustable wire suspension kit with 1.5m maximum drop (supplied separately). One suspension kit per luminaire and one for every infill 900mm and above or if ending a continuous run on an infill
- Standalone or continuous configuration
- For continuous mounting infills must be used (supplied separately)
- Standalone luminaire does not require end caps
- Continuous luminaire requires end cap kit (supplied separately)
- Infills available in 300 / 600 / 900 / 1200 / 1500mm
- Two integral emergency options available; 3hr emergency or COMEPEPS (can be wired as Easytest if required)
- IP20
- RAL Colour: Silver RAL9006 or White RAL9003
- Integral controls options available:
  - COM4 – Command 4 switching or dimming PIR detector with photocell for use with standalone luminaires
  - COMD1 – Command Elite DALI addressable PIR detector with photocell for use with continuous or standalone luminaires

## Order codes



### Hexaprism, standalone in white

				B50		
Hexaprism, standalone in white (4000K)	Fixed Output	3hr Emergency	LL/CW	L70	L80	L90
3400 lumens (32W)	BSSTH14KW	BSSTH14KWEM	108	>100k	>100k	75k
4800 lumens (47W)	BSSTH24KW	BSSTH24KWEM	105	>100k	>100k	58k



### Hexaprism, continuous in white

				B50		
Hexaprism, continuous in white (4000K)	Fixed Output	3hr Emergency	LL/CW	L70	L80	L90
3400 lumens (32W)	BSCH14KW	BSCH14KWEM	108	>100k	>100k	75k
4800 lumens (47W)	BSCH24KW	BSCH24KWEM	105	>100k	>100k	58k

### Quadraprism, standalone in white

				B50		
Quadraprism, standalone in white (4000K)	Fixed Output	3hr Emergency	LL/CW	L70	L80	L90
3400 lumens (31W)	BQSTH14KW	BQSTH14KWEM	 111	>100k	>100k	75k
4200 lumens (37W)	BQSTH24KW	BQSTH24KWEM	 111	>100k	>100k	63k
6300 lumens (51W)*	BQSTH34KW	BQSTH34KWEM	 125	>100k	>100k	63k

## Quadraprism, continuous in white

			B50			
Quadraprism, continuous in white (4000K)	Fixed Output	3hr Emergency	LL/CW	L70	L80	L90
3400 lumens (31W)	BQCH14KW	BQCH14KWEM	 111	>100k	>100k	75k
4200 lumens (37W)	BQCH24KW	BQCH24KWEM	 111	>100k	>100k	63k
6300 lumens (51W)	BQCH34KW	BQCH34KWEM	 125	>100k	>100k	63k

## Accessories

Suspension kit	BSSUSKIT
End cap kit, white (continuous luminaires only)	BSCENDCW
300mm infill, white	BSC300INFW
600mm infill, white	BSC600INFW
900mm infill, white	BSC900INFW
1200mm infill, white	BSC1200INFW
1500mm infill, white	BSC1500INFW

## Options

COM4 (standalone only)	Add Q4 before H	i.e BSSTQ4H14KW
COMD1 (DALI only)	Replace H with Q1Y	i.e BSSTQ1Y14KW
DALI	Replace H with Y	i.e BSSTY14KW
Silver	Replace W with S	i.e BSSTH14KS
COMEPS	Add suffix EP	i.e BSSTH14KWEP

\* COMEPS can be wired for Easytest functionality if required

For 3000K colour temperature, please contact Whitecroft

## LED Performance

Colour Temp	RA (CRI)	Colour consistency
4000K	>80	MacAdam 3 SDCM

## Dimensions

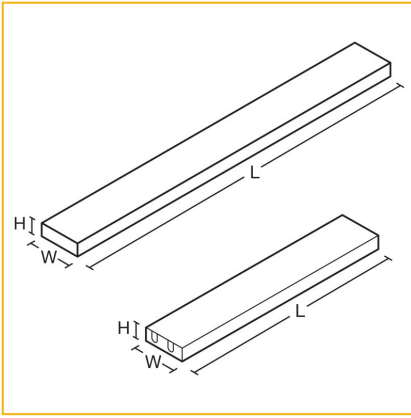

VERSION	L	W	H	KG	KG(EM)
Luminaire	1630	235	61	9	10
300mm infill	300	235	61	1.5	
600mm infill	600	235	61	3	
900mm infill	900	235	61	4.5	
1200mm infill	1200	235	61	6	
1500mm infill	1500	235	61	7.5	

## Photometric Performance

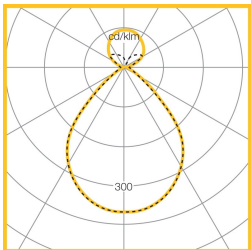

32W LED 4000k  
3400 Lumens  
LOR = 100.0%  
SHR MAX = 1.50

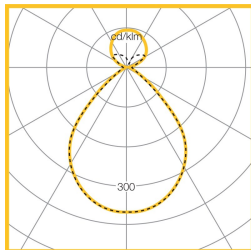

47W LED 4000k  
4800 Lumens  
LOR = 100.0%  
SHR MAX = 1.70

## Performance Guide

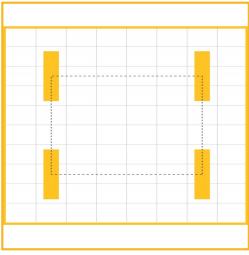

Lamps	4000K LED
Illuminance	314 lux
Spacing	3.1m x 3.0m
Maintenance	0.8
Reflectance	70/50/20
Ceiling Height	3.2m
Working plane	0.8m

---

## To Specify

Suspended LED luminaire with direct: indirect lighting ratio of 75:25. Advanced Hexaprism optic providing glare control and maximum diffusion. For continuous or standalone configuration - as Whitecroft Lighting BROADSWORD

---