

INSTALLATION INSTRUCTIONS

Troldekt® rhomb,
installed with screws



These instructions apply to installation of Troldekt® rhomb with screws on wooden battens or steel profile system. If you install Troldekt® on wooden battens, the battens should be minimum 22x95 mm. You can download installation instructions for wooden battens from www.troldekt.com.

INSTALLATION

Fix the panels using Troldekt screws spaced 25/20 mm from the edges – as indicated in the figure below.
Be careful not to overdrive the washered screws and so cause an indentation in the panel.

PANEL TYPES

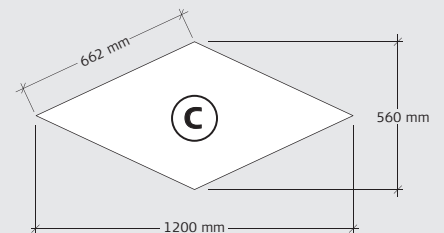
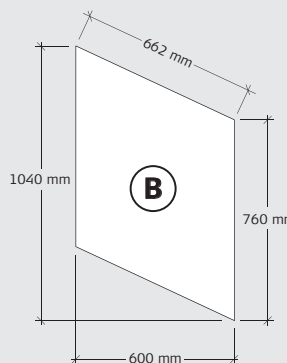
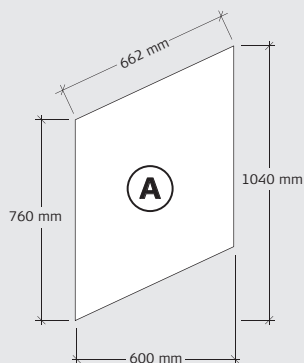

PROFILE DRAWING

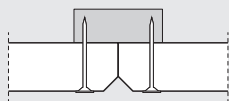

K11: With 11 mm bevel

PATTERN

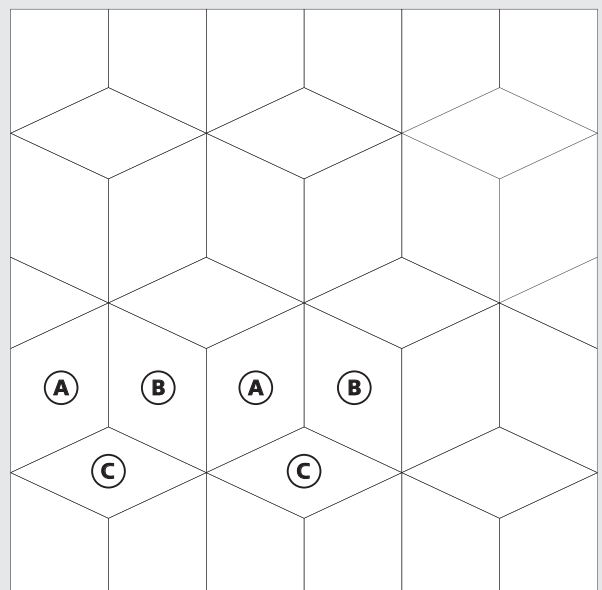
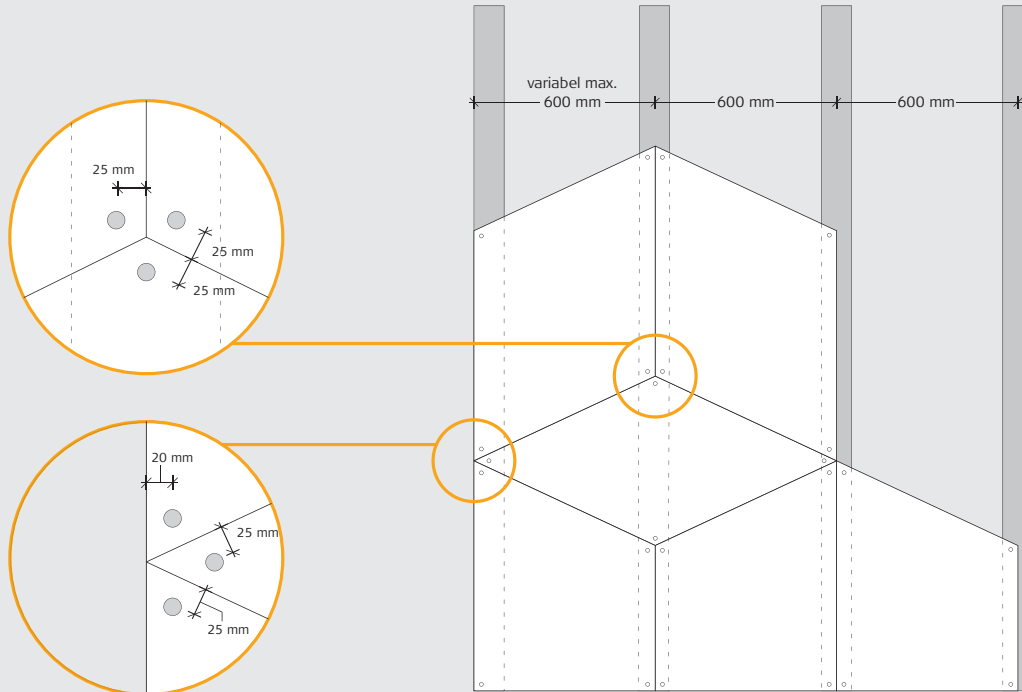

ILLUSTRATION – INSTALLATION



VAPOUR CHECK

If you need to install a vapour check, we recommend using polyethylene. The vapour check must be placed behind the wooden battens. Install the vapour check tightly

against the insulation. Please refer to the manufacturer's instructions.

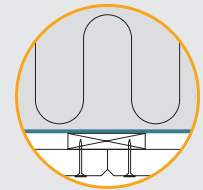

TROLDTEKT® SCREWS

PANEL THICKNESS (mm)	PANEL LENGTH (mm)	SCREW DIMENSION (mm)	NO. OF SCREWS (per panel)	MAX. SPAN (mm)
25	600	4.2x45	4	600
	1200		6	
	2000/2400		10	
			10	
35	600	4.2x55	4	600
	1200		6	
	2000/2400		10	
			10	



Troldekt structure screw for wood and steel, PH2