

Installation instructions

Troldtekt® acoustic panels K0-S, K0-FS
Installed in exposed T35 profiles in removable,
suspended ceiling system

TROLDTEKT® ACOUSTIC PANELS

K0-S: Square edge

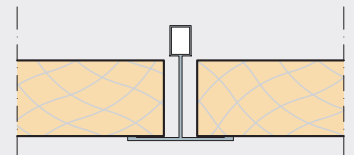
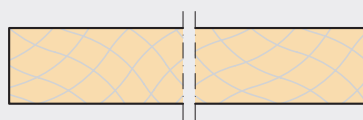

K0-FS: Rebate

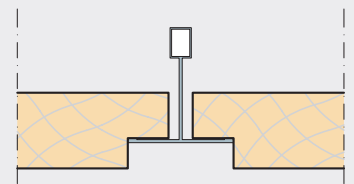
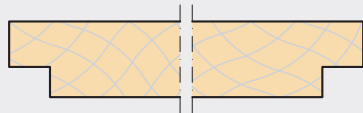

INSTALLED IN SUSPENDED T35 PROFILES

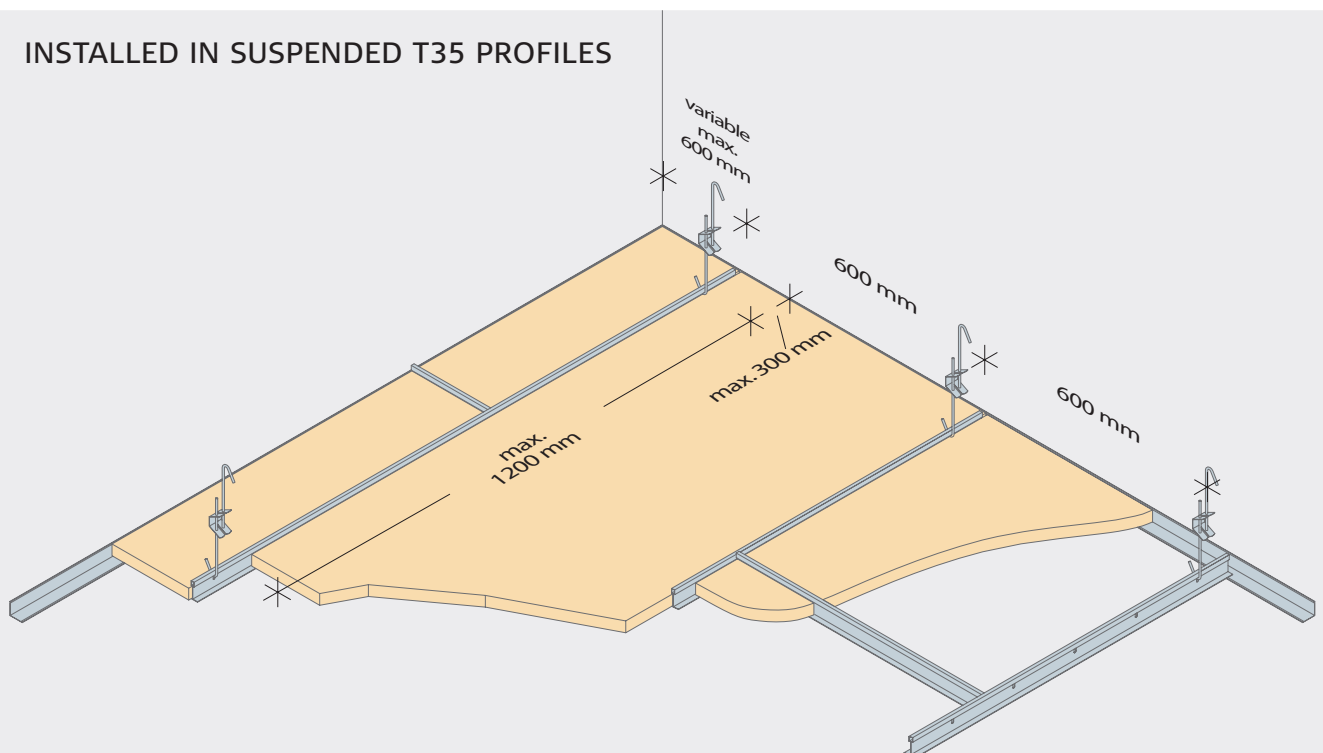

STORAGE AND ACCLIMATISATION

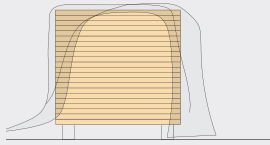

Outdoor storage

If it is necessary to store Troldtekt panels outdoors, you should protect the panels using a tarpaulin or similar. Please note that outdoor storage should be as brief as possible and never directly on the ground.

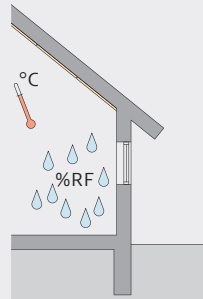

Indoor storage

If you store Troldtekt panels indoors, you must remove any packaging, as condensation could otherwise form within the packaging. Care should be taken to protect stored Troldtekt panels from moisture, direct heat and dust.

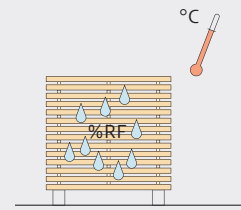

Acclimatisation

It is important that the Troldtekt panels are allowed to acclimatise prior to installation. Acclimatisation means that the panels must adapt to the temperature and moisture in the room where they are to be installed.

COMPONENTS



Product name	Perimeter angle profile, V300 - 30x30 mm	Cross tee, T60 - 24x38 mm	Main tee profile, B360 - 24 x 38 mm
Length (mm)	3000	600	3600
Quantity per pack	40 pcs	40 pcs	15 pcs
Approx. qty. per m ²	According to measurement	600x1200cm : 1.4 pcs. 600x600cm : 2.8 pcs.	1.7 linear m

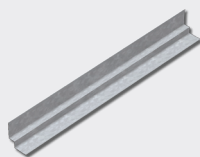

Product name	Perimeter angle profile, S300 - 22+11/9+19mm	Adjustable hanger
Length (mm)	3000	180-300 / 300-600 / 600-1000
Quantity per pack	40 pcs	100 pcs
Approx. qty. per m ²	According to measurement	1.4 pcs

INSTALLATION

- 1:** Fix the perimeter angle profiles securely to the wall with a max. spacing of 300 mm. Additionally, fasten 50 mm from profile end at joints, abutments and endings. (See figs. A and B). Hang the main tee profiles in parallel at 600 mm, with hanger points at max. 1200 mm. There should be max. 300 mm from the transverse wall to the first hanger. The main and cross tees should lap on the perimeter angle profiles.
- 2:** Fix the hangers securely to the structure above. In order to facilitate installing the Troldtekt panels, the hanger should be min. 200 mm long. In case of increased loads from e.g. lighting fixtures, the hanger spacing should be reduced. Fix heavy fixtures etc. to the structure above. Cut the main tee profiles at the wall and ensure that the slots are placed correctly in relation to the cross tees near the wall. Use a hacksaw or a profile cutter to cut the profiles. Connect the main tee profiles by inserting the tabs through the slots on the tongues of the main profiles. Then bend the tabs back to lock. (See figs. C and D).
- 3:** Place the cross tees between the main tee profiles by inserting the tongues of the cross tees into the slots of the main tee profiles, spaced at 150 mm. (See fig. E). When you have installed the profiles, check that all hangers are secure. Adjust if necessary. Now lay the Troldtekt panels in the grid.
- 4: Please note:** When installing 600 × 600 mm panels, it is important to ensure that the wood wool fibres run mainly parallel in one direction. To ensure a uniform appearance, install the panels so that the printed Troldtekt texts on the back of the panels all run in the same direction

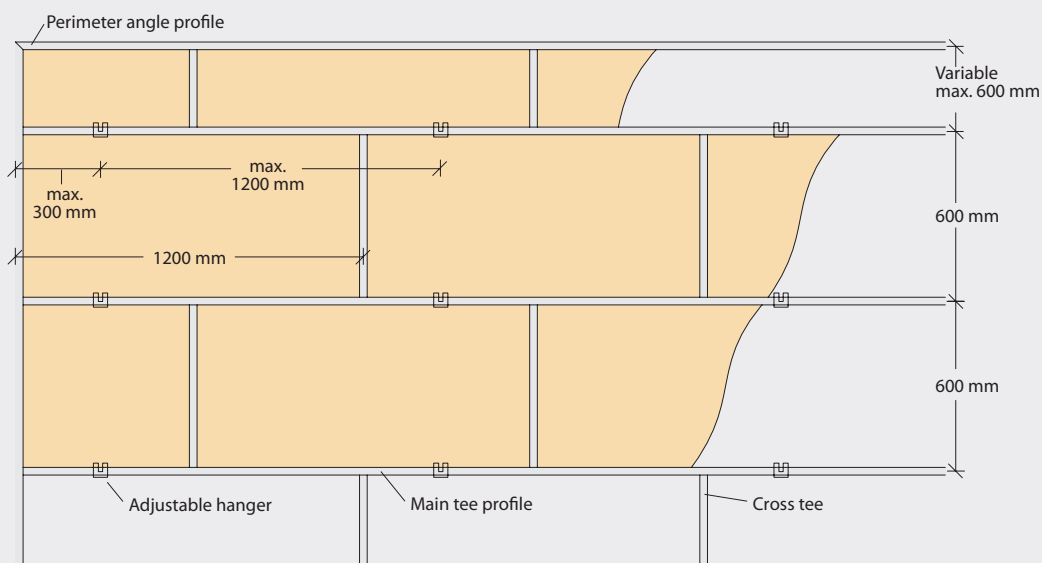
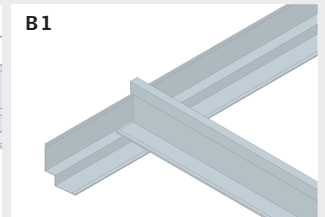
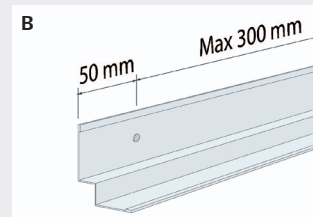
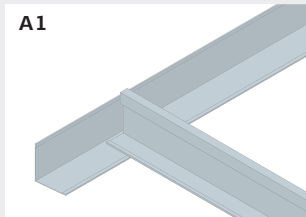
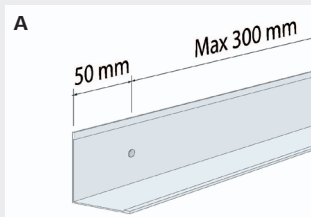
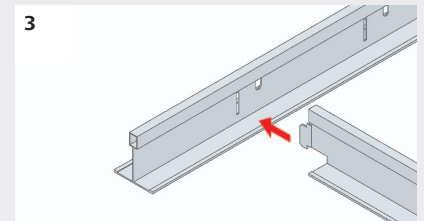
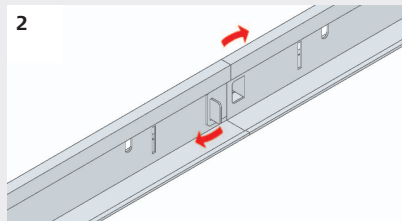
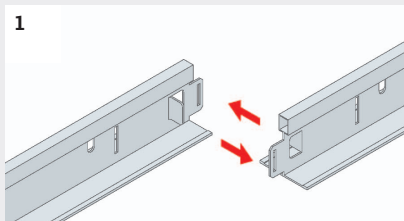

INSPECTION ON RECEIPT

On receipt, check that the number of panels is correct and that the panels do not have visible flaws and defects. Please inform the supplier immediately in case of defective

panels, as we cannot accept claims regarding visible flaws and defects after the panels have been installed.

AFTER INSTALLATION

Remove any processing dust with a vacuum-cleaner with a brush nozzle.

If the installation process has left lines or other dirt on natural wood panels, you can

remove these by using a slightly damp cloth. Touch-up paint is available as required.

SUBSEQUENT CARE AND MAINTENANCE

Troldtekt panels usually require no subsequent care. However, we recommend regular cleaning along with other surfaces – and otherwise as required.

Use a vacuum cleaner with a brush nozzle. If vacuum-cleaning is not sufficient, you can

wipe the panels using a slightly damp cloth. If you subsequently want to paint the Troldtekt ceiling, you can use a long-haired paint roller or a hand sprayer. Water-based paint will not reduce the sound-absorbing performance of the panels.

PRODUCT STANDARDS, LABELLING AND CERTIFICATES

The table below indicates the size tolerances declared by us in accordance with the standard for cement-bonded wood wool (EN 13168) and the standard for suspended ceilings (EN 13964). It is important to note that Troldtekt is a natural material and the very nature of the material composition – wood wool and cement – may result in small variations in the thickness of the panels. Panel dimensions and weights

remain inside the tolerance indicated at 23 +/- 2° C and 50 +/- 5% relative humidity. However, inappropriate storage and lack of acclimatisation can alter the dimensions and weight of the panels. It is therefore important that you observe the installation, storage and acclimatisation instructions carefully.

Due to the composition of the materials, colour shade variations may occur.



Godkendelse
MK 6.31/0379



THICKNESS (mm)	NOM. WIDTH (mm)	NOM. LENGTH (mm)	WEIGHT (kg/m ²)	NO. OF PANELS (per pallet)	PERPENDICULARITY (mm)	PLANENESS (mm)
25	600	600 1200	9.7	80* 80	≤2	≤3
(+/- 1.5)	(+/- 1)	(+/- 1.5)	(+/- 10%)			

*600×1200 mm pallet

FURTHER INFORMATION

On www.troldtekt.com you can read more about Troldtekt products. You can also download the most recent version of these

installation instructions and see the complete range of Troldtekt installation instructions.



Troldtekt A/S
Sletvej 2A
DK-8310 Tranbjerg J
Tel. +45 8747 8100
Fax +45 8747 8111
info@troldtekt.dk

www.troldtekt.com