

TG MESH INTERLAYERS

TOUGHGLAZE: MESH INTERLAYERS – TG MESH 04 SS-STAINLESS

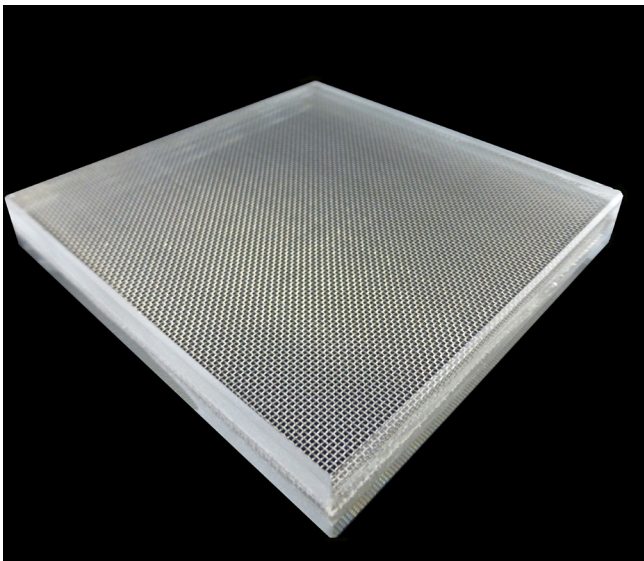

Laminated glass gives the opportunity to encapsulate a wide variety of woven metal meshes within protective glass layers. Combining the decorative and aesthetic qualities of our range of finely woven gauzes and braided weaves with the structural strength and practicality of glass. Allowing for innovative and creative design solutions.

An ideal product for use in architectural, structural, acoustic and decorative applications such as screens, partitions, balustrades, canopies, facades, wall cladding, flooring and doors. Mesh laminate products can also be integrated into insulated glass units (IGU) for exterior applications.

For wall cladding and splash backs the rear leaf of glass can be mirrored or colour coated to create an opaque backing.

Laminated glass comprises of two or more layers of glass which are bonded together with an interlayer using heat and pressure. These interlayers can be clear, coloured or translucent. Our standard TGWR- Toughglaze water resistant laminate is suitable for damp or external environments. If additional structural strength is required we offer SGP - ionoplast laminate interlayers these are five times stronger and up to 100 times stiffer than conventional laminate materials. We can also offer PVB (Polyvinyl butyral) laminate in clear, coloured or acoustic interlayers.

Glass laminating can also be combined with other decorative glass products and finishes such as digital printing, screen printing, sandblasting and colour coating giving a wealth of design possibilities.

All our Products and quality management systems are assessed to ISO 9001 by BSI. We also have in house testing facility for all materials used within our lamination process. We also offer a bespoke project sampling and mock up testing service if required.

TG MESH INTERLAYERS

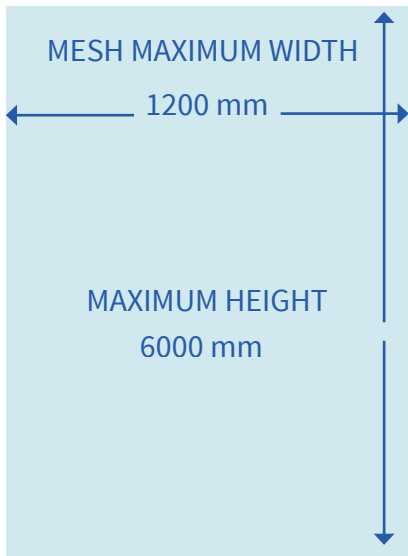
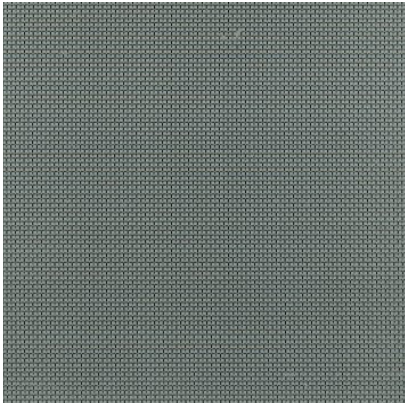

PRODUCT REF:

SPECIFICATION:

MAX. PANEL SIZE:

THICKNESS:

TG MESH 04 SS-STAINLESS

Glass available in annealed, toughened (tempered), heat soak tested and heat strengthened. To comply with BS EN 12600, BS 6206 Class A or required national safety standard. All laminated products comply with BS EN 14449.

1200mm x 6000mm

- 4+4mm (nominal overall thickness 10mm)
- 5+5 mm (nominal overall thickness 12mm)
- 6mm+6mm (nominal overall thickness 14mm)

Also available in a combination of other glass thicknesses.

GLASS OPTIONS:

Low Iron (crystal clear), Float Glass (slight green tint), Body Tint Glass, Mirror Backed.

EDGE OPTIONS:

Polished all round (PAR), Arrised all round (AAR), Ground all round (GAR).

SURFACE FINISHES:

Clear(standard), Satin Etch, Sandblasted

APPLIED FINISHES:

Colour coating-Back painted, Screen printed-Ceramic frit, Digital print- Ceramic ink, Sandblasted, Etched.

PROCESSING OPTIONS:

Shaping - CNC or water jet, drilled holes, notches, cut-outs.

TOLERANCES:

+ /- 2 mm

COLOURS:

Please see Mesh Laminate guide for various woven metal mesh options.

QUALITY & FINISH:

- Mesh is an industrially woven product and may contain marks and imperfections which may occur as part of the manufacturing process. Every attempt will be made during the laminating process to minimize the visual impact of such imperfections/characteristics but it is not possible to guarantee they will be eliminated.
- Visual inspection-Mesh should be viewed from minimum distance of 3000mm under normal daylight conditions, at 90 degree angle to the face of the glass, where possible viewing angle should be taken from head height of 1800mm from finished floor level.

PLEASE NOTE:

- When specifying this product please ensure that the end user is aware of material limitations as ToughGlaze cannot accept rejection on this basis as per our T&Cs.
- On large or complex projects we recommend prototype panels are produced for sign off and final approval.
- A mirrored or opaque backing layer of glass will need to be combined with the mesh when product is used as cladding or fixed back to substrate.
- Our standard laminate TGWR and Sentry Plus products are suitable for external or wet/damp environments, however please note PVB laminate is not suitable in these scenarios.