

DOT LED & DOT LED HALO

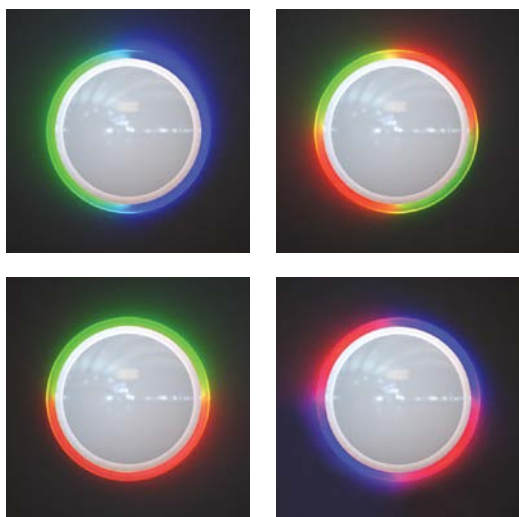

LED HALO

The DOT LED is available with an optional light green tinted halo ring backlit using either separately switched 4W white only LEDs or 4W red, green, blue (RGB) LEDs. The RGB version has 4 quadrant circuit boards and each is supplied with a switch to enable simple individual quadrant colour selection.



DIMENSIONS

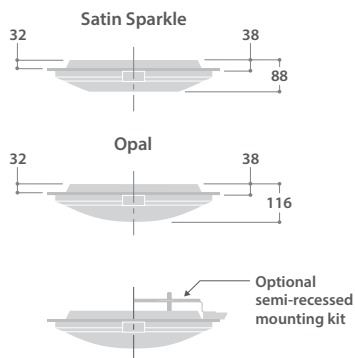
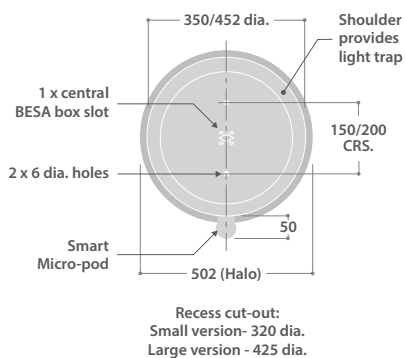

ACCESSORIES

DESCRIPTION	CAT. No.	APPROX. kg
Semi-recessed mounting kit - Small version	DOT 10103	0.27
Semi-recessed mounting kit - Large version	DOT 9917	0.32
Side entry conduit kit - Small version	DOT 11861	0.3
Side entry conduit kit - Large version ▲	DOT 11860	0.37

▲ Not suitable for use with Halo versions

DOT LED & DOT LED HALO



CIRCULAR LED LUMINAIRES SUITABLE FOR SURFACE OR SEMI-RECESSED MOUNTING



SPECIFICATION

- Spun aluminium body finished full polyester, non-yellowing white (internal and external)
- Opal or high efficiency satin sparkle effect polycarbonate cover
- Optional light green tinted backlit halo ring (4W RGB or white LEDs)
- Main LED source has LED failure protection
- Smart versions with intelligent lighting control
- Surface or semi-recessed mounting
- Fitted with 4000K LEDs

LED CHARACTERISTICS

Ra	°K	L70/B10	LL/CW
80+	4000	60K	SATIN SPARKLE
			90.5
P/U	%	R/Rx	OPAL
P	>80	R	62.5
		PF	
		>0.95	

For LED characteristics explanation see www.thorlux.com/led-characteristics

RANGE

	LED	STANDARD VERSION	APPROX. kg	WHITE LED HALO VERSION	RGB LED HALO VERSION	APPROX. kg	CIRCUIT
SMART	Large version - Satin Sparkle						
	17W	DOT 16490D	2.1	DOT 16491D	DOT 16492D	2.8	
	Large version - Opal						
	17W	DOT 16493D	2.1	DOT 16494D	DOT 16495D	2.8	
	Small version - Opal						
	14W	DOT 16579D	1.5				
STANDARD	Large version - Satin Sparkle						
	17W	DOT 16496	2.0	DOT 16497	DOT 16498	2.7	L/A
	Large version - Opal						
	17W	DOT 16499	2.0	DOT 16500	DOT 16501	2.7	L/A
	Small version - Opal						
	14W	DOT 16573L	1.4				

CIRCUIT TYPE - suffix catalogue number with:

L - non-dimming (LED) / **A** - dimming (DALI) e.g. **DOT 16496L** etc.

Smart versions use digital dimming gear and are always suffixed **D**

EMERGENCY VERSION - prefix catalogue number with:

EDT - Emergency / **TDT** - AutoTest / **DDT** - Scanlight AT e.g. **EDT 16496L** etc.

Emergency, AutoTest and Scanlight AT versions add 0.3kg to weights listed.

PHOTOMETRIC GUIDE

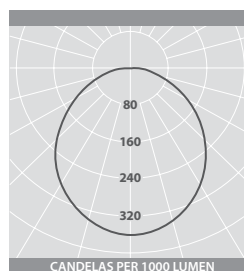

SATIN SPARKLE

Luminaire Lumen Output:
17W = 1810lm

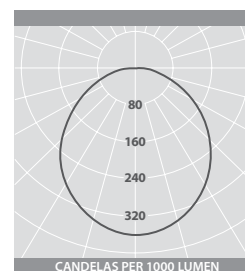

OPAL

Luminaire Lumen Output:
14W = 1000lm
17W = 1250lm

Web link: [Smart System](#)

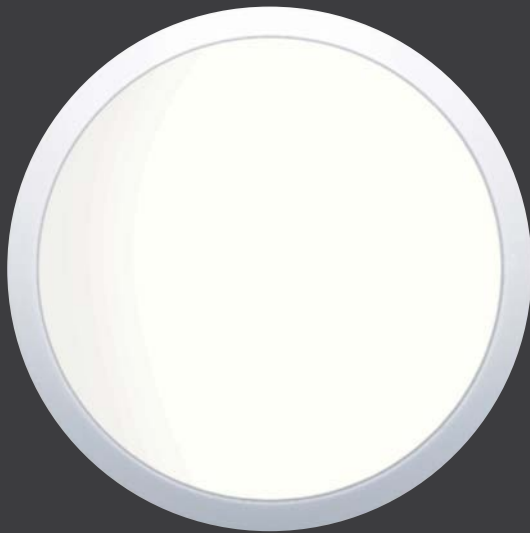

Opal diffuser



High efficiency satin diffuser



Silver



Smart version

RANGE

	LAMP	CAT. No.	APPROX. kg	CIRCUIT
SMART	Large version - Opal cover			
	38W 2D	DOT 13761D	2.3	
SMART	Large version - Satin cover			
	38W 2D	DOT 13762D	2.3	
STANDARD	Small version - Opal cover			
	28W 2D	DOT 10102J	1.7	
	Large version - Opal cover			
	28W 2D	DOT 9902	2.2	J/A
	38W 2D	DOT 9903	2.2	J/A
Large version - Satin cover				
28W 2D	DOT 12099	2.2	J/A	
38W 2D	DOT 12100	2.2	J/A	

SILVER OPTION - Add suffix **SV3** e.g. **DOT 10102JSV3**

CIRCUIT TYPE - suffix catalogue number with:

J - non-dimming (HF fluorescent) / **A** - dimming (DALI)
e.g. **DOT 9902J** etc.

Smart versions use digital dimming gear and are always suffixed **D**

EMERGENCY VERSION - prefix catalogue number with:

EDT - Emergency / **TDT** - AutoTest e.g. **EDT 9902J** etc.

Emergency and AutoTest versions add 0.7kg to weights listed.

ACCESSORIES

DESCRIPTION	CAT. No.	APPROX. kg
Semi-recessed mounting kit - Small version	DOT 10103	0.27
Semi-recessed mounting kit - Large version	DOT 9917	0.32
Side entry conduit kit - Small version	DOT 11861	0.3
Side entry conduit kit - Large version ▲	DOT 11860	0.37

▲ Not suitable for use with Halo versions

CIRCULAR 2D LUMINAIRES SUITABLE FOR SURFACE OR SEMI-RECESSED MOUNTING

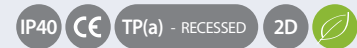

SPECIFICATION

- Spun aluminium body finished full polyester, non-yellowing white as standard (internal and external)
- Silver option
- Opal or high efficiency satin polycarbonate cover version with a measure of upward light
- Smart versions with intelligent lighting control
- Surface or semi-recessed mounting
- Fitted with 3500K lamp

DIMENSIONS

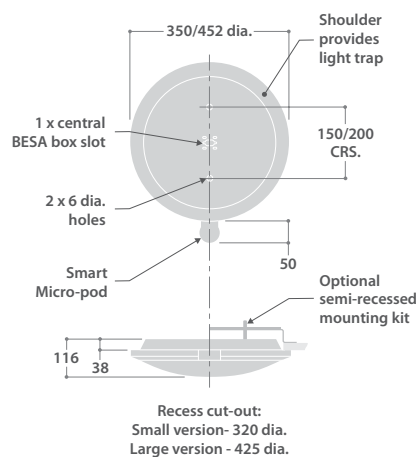

PHOTOMETRIC GUIDE

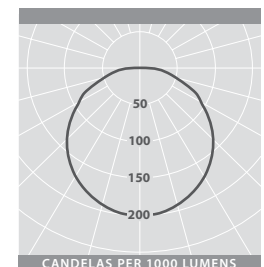

38W 2D LAMP LARGE SATIN VERSION

D.L.O.R. 62%

Factors:
28W Small Opal = 0.79
28W Satin = 0.98
28W Opal = 0.71
38W Opal = 0.69

Web link: [Smart System](#)



BACKLIT 2D CIRCULAR LUMINAIRES WITH LIGHT GREEN TINTED FEATURE GLASS-LIKE ACRYLIC RING

IP40 CE TP(a) - RECESSED 2D

SPECIFICATION

- Spun aluminium body finished full polyester, non-yellowing white (internal and external)
- Opal or high efficiency satin polycarbonate cover versions
- Smart versions with intelligent lighting control
- Surface or semi-recessed mounting
- Fitted with 3500K lamp

RANGE

	LAMP	CAT. No.	APPROX. kg	CIRCUIT
SMART	Opal cover 38W 2D	DOT 13763D	2.8	
	Satin cover 38W 2D	DOT 13764D	2.8	
STANDARD	Opal cover 28W 2D	DOT 12439	2.7	J/A
	Opal cover 38W 2D	DOT 12440	2.7	J/A
	Satin cover 28W 2D	DOT 12599	2.7	J/A
	Satin cover 38W 2D	DOT 12600	2.7	J/A

CIRCUIT TYPE - suffix catalogue number with:
J - non-dimming (HF fluorescent) / **A** - dimming (DALI)
 e.g. **DOT 12439J** etc.

Smart versions use digital dimming gear and are always suffixed **D**

EMERGENCY VERSION - prefix catalogue number with:
EDT - Emergency / **TDT** - AutoTest e.g. **EDT 12439J** etc.
 Emergency and AutoTest versions add 0.7kg to weights listed.

PHOTOMETRIC GUIDE

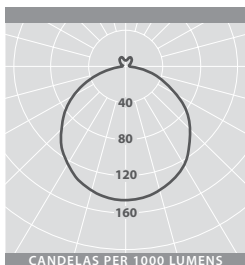

38W 2D LAMP SATIN VERSION

D.L.O.R. 60%
 Factors:
 28W Satin = 0.98
 28W Opal = 0.80
 38W Opal = 0.80

DIMENSIONS

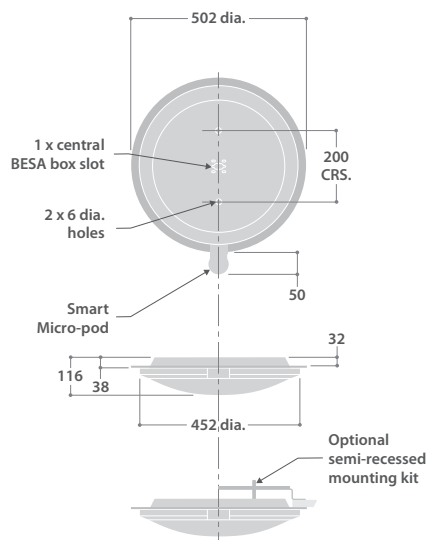

ACCESSORIES

DESCRIPTION	CAT. No.	APPROX. kg
Semi-recessed mounting kit - Large version	DOT 9917	0.32

Web link: [Smart System](#)