

thermo  
**Sphere**

**ELECTRIC CONVECTOR**

**Model: TSCR-0500  
TSCR-1000  
TSCR-1500  
TSCR-2000**

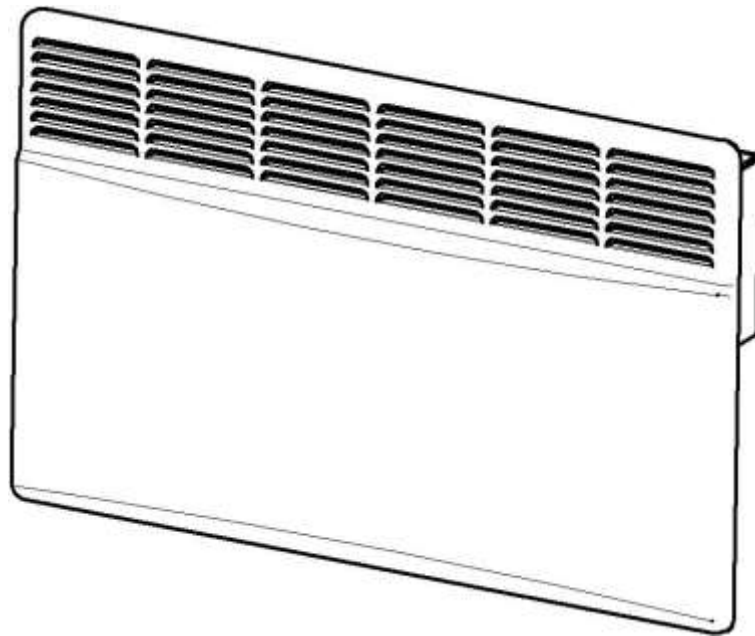

**OPERATION INSTRUCTIONS**



**Warning!** Before operating the heater, please read these instructions thoroughly to avoid damage and hazardous situations. Keep these instructions even once you have installed your heater.

## 1 GENERAL INSTUCTIONS

This appliance with electronic room temperature control plus week timer is intended for normal household use and not for use in commercial/industrial environment, in vehicles or on board ships or aircrafts.

The product is equipped with an electronic device that allows the product to automatically vary its heat output over a certain time period, in relation to a certain required level of indoor heating comfort, and allows the setting of timing and temperature levels for a full week. During the 7-day period the settings must allow a variation on a day-to-day basis.

The product is equipped with an electronic device that reduces the heat output when a window or door has been opened.

Before any operation remove the packaging and check product integrity. In case of defects or damages do not try to repair it yourself but contact your dealer.

Do not let children play with the packaging and protect the environment by disposing of the packaging in accordance with the national regulations for waste processing.

Disconnect the power before carrying out any work on the heater.

The convectors are designed for twenty-four-hour operation without constant supervision.

## 2 TECHNICAL DATA

- Rated supply voltage 230 V  $\pm$  10 V
- Current frequency 50 Hz  $\pm$  1 Hz
- Protected against water projections IP24
- Class of protection from electric current shock II

Table 1

| Model                          | TSCR-0500   | TSCR-1000   | TSCR-1500   | TSCR-2000   |
|--------------------------------|-------------|-------------|-------------|-------------|
| Rated power, kW                | 0,5         | 1,0         | 1,5         | 2,0         |
| Rated current, A               | 2,1         | 4,3         | 6,5         | 8,7         |
| Sizes, mm, no more (W x D x H) | 460x120x450 | 530x120x450 | 660x120x450 | 785x120x450 |

## 3 COMPONENTS

- Electric convector - 1
- Fixing brackets for wall mounting - 1
- User instruction - 1

#### 4 SAFETY REQUIREMENTS

The appliance is not to be used by persons (including children) with reduced physical, sensory or mental capabilities, or lack of experience and knowledge, unless they have been given supervision or instruction, children being supervised not to play with the appliance.

This appliance can be used by children aged from 8 years and above and persons with reduced physical, sensory or mental capabilities or lack of experience and knowledge if they have been given supervision or instruction concerning use of the appliance in a safe way and understand the hazards involved.

Children shall not play with the appliance.

Cleaning and user maintenance shall not be made by children without supervision.

Children of less than 3 years should be kept away unless continuously supervised.

Children aged from 3 years and less than 8 years shall only switch on/off the appliance provided that it has been placed or installed in its intended normal operating position and they have been given supervision or instruction concerning use of the appliance in a safe way and understand the hazards involved. Children aged from 3 years and less than 8 years shall not plug in, regulate and clean the appliance or perform user maintenance.

**CAUTION — Some parts of this product can become very hot and cause burns. Particular attention has to be given where children and vulnerable people are present.**

**WARNING:** Children must not lean on the appliance. Under certain circumstances, there is a risk that its surface may cause burns to the skin of young children. If there is any risk of this at all, install a protection grill.

**WARNING:** To reduce the risk of fire, keep textiles, curtains, or any other flammable material a minimum distance of 1m from the air outlet.

**WARNING:** Do not use this heater in small rooms when they are occupied by persons not capable of leaving the room on their own, unless constant supervision is provided.

Do not introduce objects or paper into the device.

The heater must be installed by a qualified electrician in accordance with the local regulations.

If the power cable is damaged, it must be replaced by the manufacturer or its service agent or similarly qualified person to avoid any risk.

All work on the interior of the appliance must be carried out by a licensed electrician.



**WARNING:** In order to avoid overheating, do not cover the heater.  
The heater carries the warning symbol indicating that the heater may not be covered.

#### IT IS PROHIBITED!

- Do not obstruct the grills, even partially (either on the front of the appliance or underneath it) otherwise the appliance may overheat.
- To place easily inflammable materials and objects close to the convector.
- The heater should not be installed directly under a fixed mains power socket.
- The heater should not be installed where the controls may be touched by a person using a bath or shower.
- To use convectors in immediate proximity to a bath, shower bath or a swimming-pool.
- To touch a plug of a power cord and to convector with wet hands.

## 5 PREPARATIONS FOR OPERATION

5.1 Unpack the convector. Keep the convector at room temperature not less than one hour after placing the convector in a warm room from cold in case of the dew fall-out.

5.2 This equipment was designed to be installed in a residence. Please ask your distributor before using it for any other purpose.

Do not install the convector in a draught that might affect adjustment (for example, under a central mechanical ventilation unit etc...)

5.3 The convector should be installed according to normal trade practice and in compliance with legislation in the relevant country (the IEE Wiring Regulations). Check the correspondence of the mains to the data on the firm label which is on the convector rear wall; check also the mains and the protection devices ability to with stand the consumption current.

5.4 To stationary installation of convector:

- It is necessary to hold minimum distances from the objects when mounting the convector as shown in Figure 2, Figure 3 (dimension in cm);
- Execute on a wall a marking for fixing (see fig. 1, table 2);
- Fix the bracket in any accessible way, having provided reliable fastening of convector in all term of operation;
- Mount the convector on the hook-on brackets.

Table 2

|                 |     |     |     |     |
|-----------------|-----|-----|-----|-----|
| Rated power, kW | 0,5 | 1,0 | 1,5 | 2,0 |
| L, mm           | 96  | 144 | 276 | 396 |

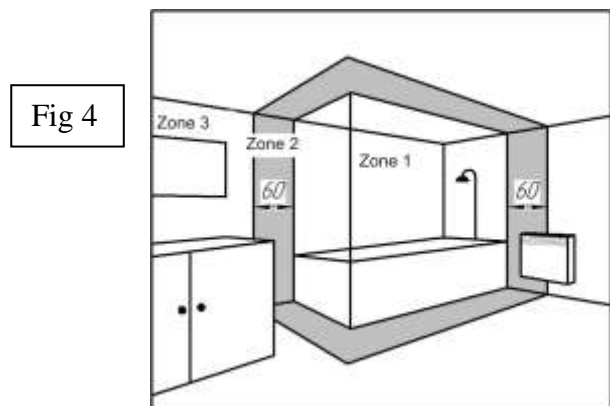
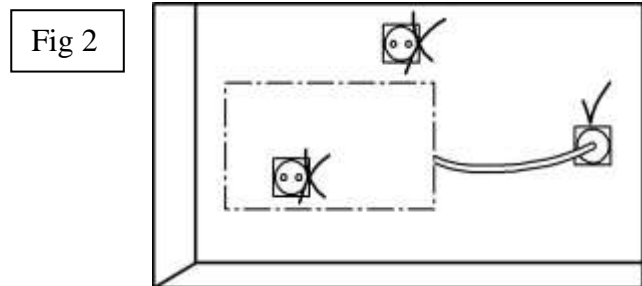
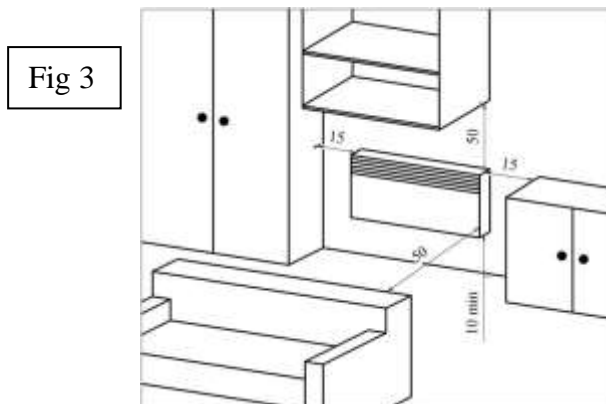
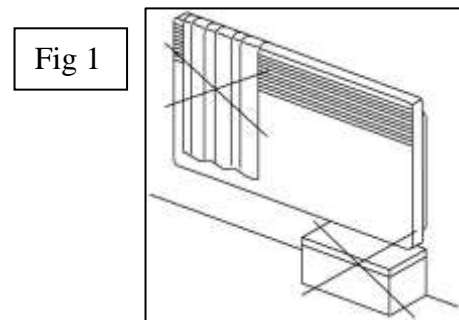

5.5 Convectors with protected against splashed water IP24 can be installed in bathroom (see fig. 4).

Do not install the convector:

- In zone 1 of bathrooms;
- In zone 2, if the person being in a bath or shower can touch to switches and other controls.
- In humid areas such as bathrooms and kitchens the power socket must be installed at least 25 cm above the floor.

## 6 ORDER OF OPERATION

**Warning:** It is strictly forbidden to switch on and operate the convector without fixing it to the brackets on the wall or on supports on the floor.

The convector can only be switched on and operated in a vertical position with the air intake grate down. When the convector is switched on for the first time, the smell from evaporation of the conservation materials is possible. It is recommended to ventilate the room.

### 6.1 Description of controls

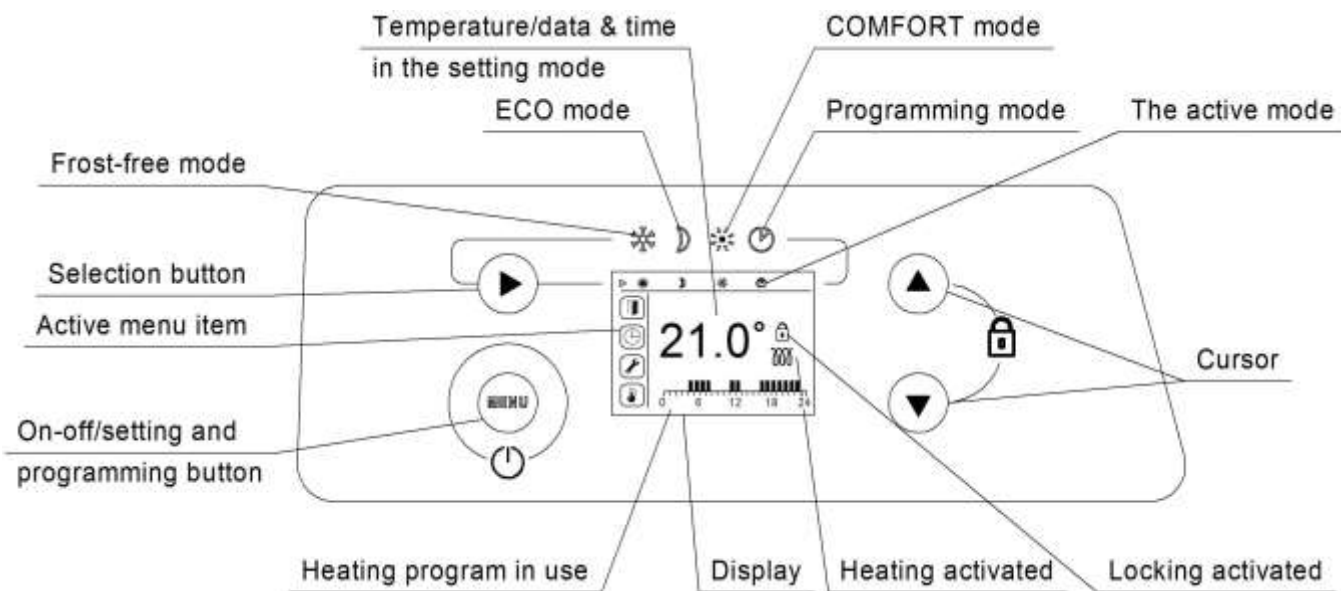

Fig. 6

### 6.2 Operating





Connect the convector cord plug to the power socket. The indicators on the control panel will light up and will show the time (Fig. 6). The convector is ready for operation.

#### 6.2.1 Switch ON/OFF your appliance.

To switch on your convector press the button ON-OFF/MENU. The last mode used will be displayed. To switch off your convector press and hold the button ON-OFF/MENU. The time will be displayed.

## 6.2.2 Selecting the operating mode of the convector and setting the mode parameters.

### 6.2.2.1 Heating Modes

| Pictogram   | Description | When used  |
|---|-------------|--|
|  | Comfort     | When at home. The convector works to maintain the comfort temperature set. Used to select the preferred. The default temperature is 21°C, you can adjust it from Economy temperature +1°C to 30°C.   |
|  | Economy     | When you are away from home for short periods (from 2 to 48 hours) or you are sleeping. The convector works to maintain the Economy temperature set and save energy. The default temperature is 17°C, you can adjust it from 7°C to Comfort temperature - 1°C. |
|  | Frost-free  | When you are away from home for long periods (more than 48 hours). The temperature is automatically set to around 7°C and cannot be changed.   |
|  | Programming | When you want preset programmed operation. You can choose one of five pre-record programs or one of three programs which can be customized   |

#### 6.2.2.2 Comfort mode.

- Press the button ► several time until the cursor is below the pictogram . You can adjust Comfort temperature by press the top ▲ or bottom ▼ button.

After 10 seconds of inactivity the temperature is recorded, the display will show the setting temperature.

If the adjusted control temperature is higher than the room temperature, the heating indicator lights up and the convector starts heating the room.

**Note.** If the screen is not switched on, push any key to make it light up. The screen lights up and stays on for 30 seconds after the last time any key is pushed.

When the screen is switched off, the first time any key is pushed the screen lights up without activating the function controlled by the key pushed.

#### 6.2.2.3 Economy mode.

- Press the button ► several time until the cursor is below the pictogram . You can adjust Economy temperature by press the top ▲ or bottom ▼ button.

After 10 seconds of inactivity the temperature is recorded.

- If you set the control temperature setting in COMFORT mode lower than the ECONOMY mode setting, the ECONOMY adjustment temperature setting will automatically decrease by 1 ° C lower relative to the new COMFORT setting.

#### 6.2.2.4 Frost- free mode.

This mode keeps the temperature of about 7 ° C to prevent freezing rooms.

- Press the button ► several time until the cursor is below the pictogram .

#### 6.2.2.5 Programming mode

Before setting the program, make sure the time and date are set in the convector. If not, please refer to point 6.2.2.7.

You can chose periods of Comfort and Economy temperature using one of the eight present programs.

Five programs are pre-record: Pr1, Pr2, ... Pr5.

Three programs you can be customize: Pr6, Pr7 and Pr8.

Pre-record programs:

Pr1 is recommended for a constant presence

Pr2 is recommended for absence in the day

Pr3 is recommended for absence in the day and if you return to home for lunch time

Pr4 permanent Comfort

Pr5 permanent Economy

The initial view of the programs P6, P7, P8 is permanent ECONOMY mode.

| Hours<br>Prog. | 0.00 | 1.00 | 2.00 | 3.00 | 4.00 | 5.00 | 6.00 | 7.00 | 8.00 | 9.00 | 10.00 | 11.00 | 12.00 | 13.00 | 14.00 | 15.00 | 16.00 | 17.00 | 18.00 | 19.00 | 20.00 | 21.00 | 22.00 | 23.00 | 24.00 |
|----------------|------|------|------|------|------|------|------|------|------|------|-------|-------|-------|-------|-------|-------|-------|-------|-------|-------|-------|-------|-------|-------|-------|
| Pr1            |      |      |      |      |      | ■    | ■    | ■    | ■    | ■    | ■     | ■     | ■     | ■     | ■     | ■     | ■     | ■     | ■     | ■     | ■     | ■     | ■     | ■     |       |
| Pr2            |      |      |      |      |      | ■    | ■    | ■    | ■    |      |       |       |       |       |       |       |       | ■     | ■     | ■     | ■     | ■     | ■     |       |       |
| Pr3            |      |      |      |      |      | ■    | ■    | ■    | ■    |      |       |       | ■     | ■     |       |       |       |       | ■     | ■     | ■     | ■     | ■     |       |       |
| Pr4            | ■    | ■    | ■    | ■    | ■    | ■    | ■    | ■    | ■    | ■    | ■     | ■     | ■     | ■     | ■     | ■     | ■     | ■     | ■     | ■     | ■     | ■     | ■     | ■     | ■     |
| Pr5            |      |      |      |      |      |      |      |      |      |      |       |       |       |       |       |       |       |       |       |       |       |       |       |       |       |
| Pr6            | ■    | ■    | ■    | ■    | ■    | ■    | ■    | ■    | ■    | ■    | ■     | ■     | ■     | ■     | ■     | ■     | ■     | ■     | ■     | ■     | ■     | ■     | ■     | ■     | ■     |
| Pr7            | ■    | ■    | ■    | ■    | ■    | ■    | ■    | ■    | ■    | ■    | ■     | ■     | ■     | ■     | ■     | ■     | ■     | ■     | ■     | ■     | ■     | ■     | ■     | ■     | ■     |
| Pr8            | ■    | ■    | ■    | ■    | ■    | ■    | ■    | ■    | ■    | ■    | ■     | ■     | ■     | ■     | ■     | ■     | ■     | ■     | ■     | ■     | ■     | ■     | ■     | ■     | ■     |

■ - Comfort mode, □ - Economy mode, ■ - The user customize programs

- Press the button ► several time until the cursor is below the pictogram .

On each day of the week the default program is Pr1.

If you want the modify the program press the button ON-OFF/MENU several times until the selection of the programming icon .

- Press the button ► to choose the day, press the top ▲ or bottom ▼ button to choose your desired program from Pr1 to Pr5.

After 10 seconds of inactive the program is recorded.

- Repeat this operation for each day of the week.

You can modify the active temperature by press the top ▲ or bottom ▼ button. After 10 seconds of inactive the temperature is recorded.

- You can choose also Pr6 ... Pr8 programs which can be customized following the instructions listed in paragraph 6.2.2.10

### 6.2.2.6 Open window detection.

This function makes it possible to detect an open window and automatically to switch off heating for 15 minutes.

- Press the button ON-OFF/MENU several times until the selection of the open window icon .

You can chose to activate (ON) or deactivate (OFF) function by press the top ▲ or bottom ▼ button. After 10 seconds of inactivity the selection is recorded.

Reinstating normal operation occurs automatically, but can be activated by pushing any key.

### 6.2.2.7 Adjust time and date.

To adjust date and time push the button ON-OFF/MENU several times until the selection of the wrench icon .

- Press the button ►, when the hour icon blinks you can adjust the hours by press the top ▲ or bottom ▼ button.
- Press the button ►, when the minute icon blinks you can adjust the minutes by press the top ▲ or bottom ▼ button.
- Press the button ►, when the day icon blinks you can adjust the day by press the top ▲ or bottom ▼ button. Monday is 01, Tuesday is 02 ... Sunday is 07.  
After 10 seconds of inactivity day and time are recorded.

### 6.2.2.8 Calibrate the temperature.

To calibrate the temperature push the button ON-OFF/MENU several times until the selection of the calibration icon , t OFFSET appears. You can calibrate the difference of temperature (+3°C/-3°C) by press the top ▲ or bottom ▼ button. After 10 seconds of inactivity the convector switches on the standard display.

### 6.2.2.9 Locking controls.

You can lock the controls with a long pressure simultaneously on the ▲ and ▼ buttons to prevent unauthorized people from altering them, the padlock icon will appear. Made the same operation to unlock the controls.

**Note:** If the appliance is disconnected the last setting are saved.

### 6.2.2.10 Customize P6, P7, P8 programs.

Program P6, P7, P8 may be modified to suit the user's needs. The initial view of the programs P6, P7, P8 is permanent ECONOMY mode. The user can set up to three intervals of Comfort mode at each program.

For example, consider the setting of the daily program Pr6, for the third day of the week, with three periods of COMFORT:

- the first period from 4 hours to 7 hours;
- the second period from 11 hours to 12 hours;
- the third period from 18 hours to 22 hours.

- Press the button ON-OFF/MENU several times until the selection of the programming icon .
- Press the button ► to choose the day, press the top ▲ or bottom ▼ button to choose program Pr6.

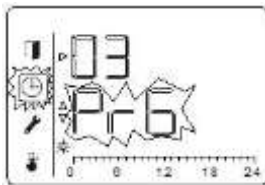

03-it is **third** day, the **Pr6** program.  
Pr6- ECONOMY mode for 24 hours

- Press simultaneously MENU button and ► button to switch to the program settings mode. When enter to the program setup mode, a "pencil" and the number of the program to be adjusted must be displayed as on the picture below.

The character of adjustment

Number of adjusted program

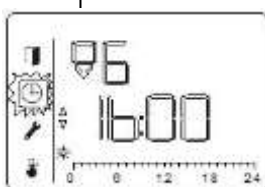

00- indication of the hour of the beginning of the first period of the COMFORT mode (1b-beginning)

The period number of COMFORT mode

The beginning of period (b) or the end of period (E)

- Use the ▲ or ▼ buttons to change the hour value of the start of the COMFORT mode. Set the beginning of the first period to 4 hours.

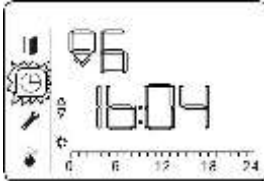

Indication of the start time of the COMFORT mode (1b-beginning)

- Press the ► button to confirm the selected value of the beginning of the COMFORT mode. The program switches to the mode for selecting the hour of the end of the COMFORT mode.

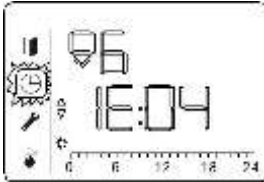

The indication of the hour of the end of the COMFORT mode (1E-end)

- Use the ▲ or ▼ buttons to change the hour value of the end of the COMFORT mode. Set the end of the first period to 7 hours.

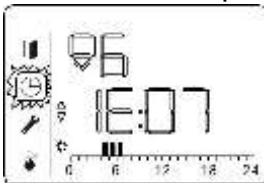

The scale of the daily program displays the sectors of the first period COMFORT.

- Press the ► button to confirm the selected value of the end of the COMFORT mode. The program switches to the hour selection mode, from which the second period of the COMFORT mode begins.

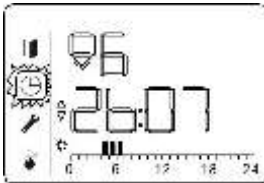

The display will show the start time of the second period COMFORT 2b07.

- Use the ▲ or ▼ buttons to change the hour value of the start of the second period COMFORT.

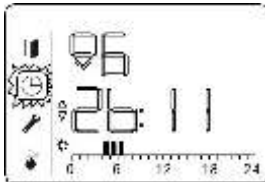

Set the start of the second period to 11 hours.

- Press the ► button to confirm the selected value of the beginning of the second period COMFORT. The program switches to the mode for selecting the hour of the end of the second period COMFORT.

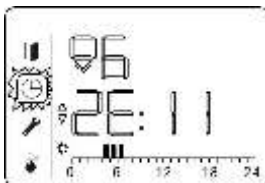

- Use the ▲ or ▼ buttons to change the hour value of the end of the second period COMFORT. Set the end of the second period to 12 hours.

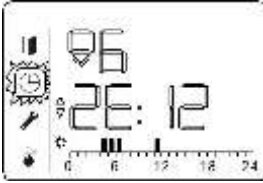

The scale of the daily program displays the sector of the second period COMFORT.

- Press the ► button to confirm the selected value of the end of the second period COMFORT. The program switches to the hour selection mode, from which the third period of the COMFORT mode begins.

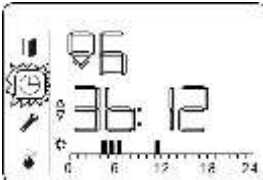

The display will show the start time of the third period COMFORT 3b12.

- Use the ▲ or ▼ buttons to change the hour value of the start of the third period COMFORT. Set the start of the second period to 18 hours.

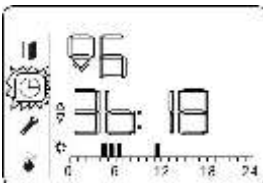

- Press the ► button to confirm the selected value of the beginning of the third period COMFORT. The program switches to the mode for selecting the hour of the end of the third period COMFORT.

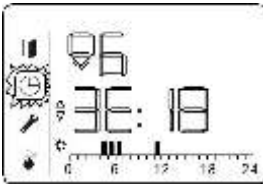

- Use the ▲ or ▼ buttons to change the hour value of the end of the third period COMFORT. Set the end of the third period to 22 hours.

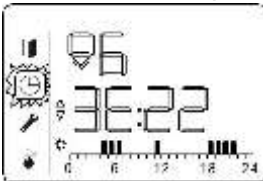

The scale of the daily program displays the sector of the third period COMFORT.

- Press the ► button to confirm the selected value of the end of the third period COMFORT.

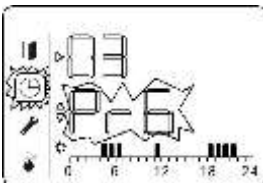

After confirming the end of the third COMFORT period, the system automatically exits the setup mode to the main user menu.

If it is necessary to adjust only one or two periods in the daily program the beginning and the end of other periods confirm by pressing the ► button.

You can apply the customized Pr6 program to any day of the week.

You can customize the Pr7 and Pr8 programs in the same way as Pr6.

### 6.3 Dismounting the convector.

Press and hold the button ON-OFF/MENU until the convector turns off, the indication goes out and will to show the time. Disconnect the convector cord plug from the power socket.

Lift up the convector until the bottom hooks of the brackets come out of the holes of the air intake grate of the convector. Then lower the convector and remove it from the top hooks of the brackets.

**Note:** Electronic appliances with a microprocessor could be affected by some serious mains disturbances (not compliant with CE regulations defining interference protection levels). If there are any problems (thermostat jammed, etc.) cut the appliance power supply (fuse, circuit-breaker, etc.) then restart the appliance after 5 minutes.

## 7 MAINTENANCE

To maintain performances of your unit, you should clean the upper and lower grilles of the unit about twice a year using a vacuum cleaner or a brush.

Dirt may collect on the grille of the unit if the atmosphere is polluted. This phenomenon is due to the poor quality of the ambient air. In this case, it is recommended to check that the room is well ventilated (ventilation, air inlet, etc.), and that the air is clean. The unit will not be replaced under the guarantee because of this type of dirt.

The unit casing should be cleaned with a damp cloth, never use abrasive products.

## 8 WARRANTY CONDITIONS

This guarantee is applicable for 2 years from the date of original purchase and shall be valid for no more than 30 months from the date of manufacture.

The warranty covers exchange or supply of parts found to be faulty, excluding any damages and interest payments.

This guarantee excludes damage by neglect, shipping or accident and any damage due to incorrect installation, use for purposes other than those intended or failure to observe the instructions given.



Products with this symbol should not be placed with garbage but must be collected separately and recycled.

Collect and recycling of end life products should be done according to the provisions of local ordinances (DEE 2002/96/CE).

Thermogroup Ltd T/A ThermoSphere  
Pattenden Lane Marden  
TN12 9QJ  
United Kingdom

0800 019 5899  
[hello@thermosphere.com](mailto:hello@thermosphere.com)  
[www.thermosphere.com](http://www.thermosphere.com)

Information with regard to ecodesign requirements according to Regulation (EU) 2015/1188  
 EN – Information requirements for electric fixed local space heaters

| Model identifiers                                   | TSCR-0500  | TSCR-0500 | TSCR-0500 | TSCR-0500 |
|---|--|-----------|-----------|-----------|
| <b>Heat output</b>                                  |  |           |           |           |
| Nominal heat output $P_{nom}$ , kW                  | 0,5  | 1,0       | 1,5       | 2,0       |
| Minimum heat output $P_{min}$ , kW                  | 0,1  | 0,2       | 0,3       | 0,4       |
| Maximum continuous heat output $P_{max,c}$ , kW     | 0,5  | 1,0       | 1,5       | 2,0       |
| <b>Auxiliary electricity consumption</b>            |  |           |           |           |
| At nominal heat output ( $e_{lmax}$ ), kW           | 0,0004   | 0,0004    | 0,0004    | 0,0004    |
| At minimum heat output ( $e_{lmin}$ ), kW           | 0,0003   | 0,0003    | 0,0003    | 0,0003    |
| In standby mode ( $e_{lSB}$ ), kW                   | 0,00035  | 0,00035   | 0,00035   | 0,00035   |
| <b>Type of heat output/room temperature control</b> | With electronic room temperature control plus week timer   |           |           |           |
| Other control options                               | Room temperature options with open window detection  |           |           |           |
| Contact details                                     | Thermogroup Ltd T/A ThermoSphere<br>Pattenden Lane Marden TN12 9QJ United Kingdom<br>0800 019 5899<br><a href="mailto:hello@thermosphere.com">hello@thermosphere.com</a><br><a href="http://www.thermosphere.com">www.thermosphere.com</a> |           |           |           |