



tenon

System Overview

Quality | Style | Choice

www.tenonpartitions.co.uk

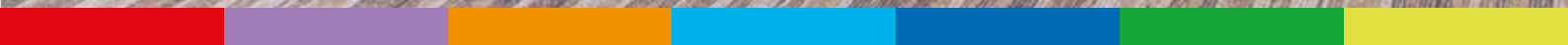



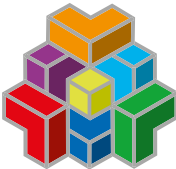

tenon

Introduction

Tenon Partition Systems is a leading brand of high quality partitioning products available exclusively from SIG Interiors.

A comprehensive range of demountable and relocatable systems to meet all budgets and complex design specifications.

The selection of partitioning is made simple with Tenon whilst providing solutions to the changing demands of the modern workplace. Whether your requirements are for acoustic performance, fire resistance or varied glazing configurations, there is a Tenon system perfectly suited to meet your challenge.

Quality | Style | Choice



The UK's leading specialist supplier of interior fit-out products to the construction industry with stockists located throughout the UK, SIG Interiors offer an unrivalled range of products, including Suspended Ceilings, Partitions & Washrooms, Raised Access Flooring, Drywall and much more.

SIG Interiors is part of the SIG group which links together its Interiors, Insulation, Technical Insulation, Construction Accessories and Fixings businesses, meaning that you can now source a huge range of products, all from your local SIG Interiors branch, which becomes a true 'one-stop shop' for specialists.



Product Specialists

Tenon Partitions work closely with contractors and architects across the UK to create inspiring working environments. Saving you time and money, we'll support you through all stages of your project to establish the perfect partition solution.

Estimating Help

Using in house advanced software we can produce detailed layouts and 3D visualisations through to a full breakdown of module components and costings - all with the guarantee of exceptional customer service. A team of Tenon specialists is available for in-the-field assistance backed up by a continually developing network of Tenon Office Interior Centres nationwide.

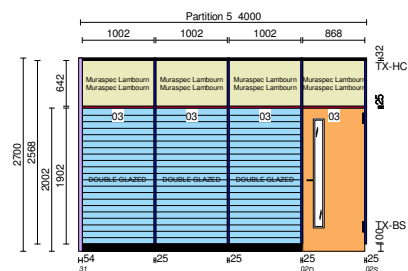
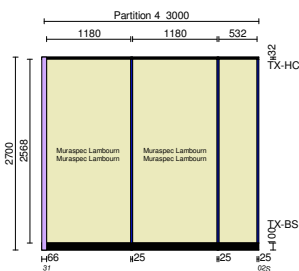
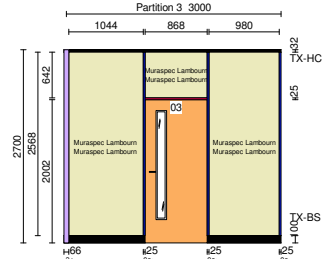
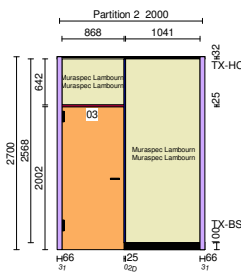
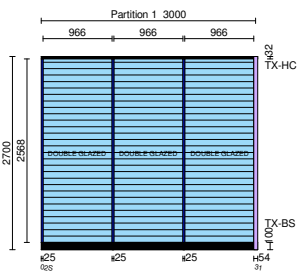
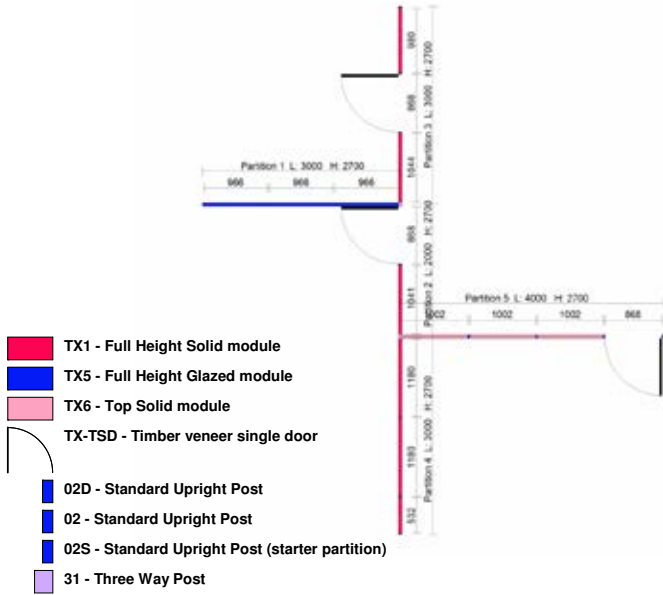

Tenon Online

The dedicated Tenon website www.tenonpartitions.co.uk provides comprehensive details of the full Tenon Partitions product range and technical guidance and performance data on each system to help customers select the right product to meet project specifications. Users can also seek inspiration from best practice case studies on how Tenon Partitions have been applied at various projects around the UK. An exclusive '3D Showroom' software allows visitors to view different fit-out options in a simulated office environment. Co-ordinate products, colours, textures, finishes to simulate the look and feel of your design projects. Once created, the finished design can be printed and sent to one of SIG Interiors UK wide stockists for a quotation.

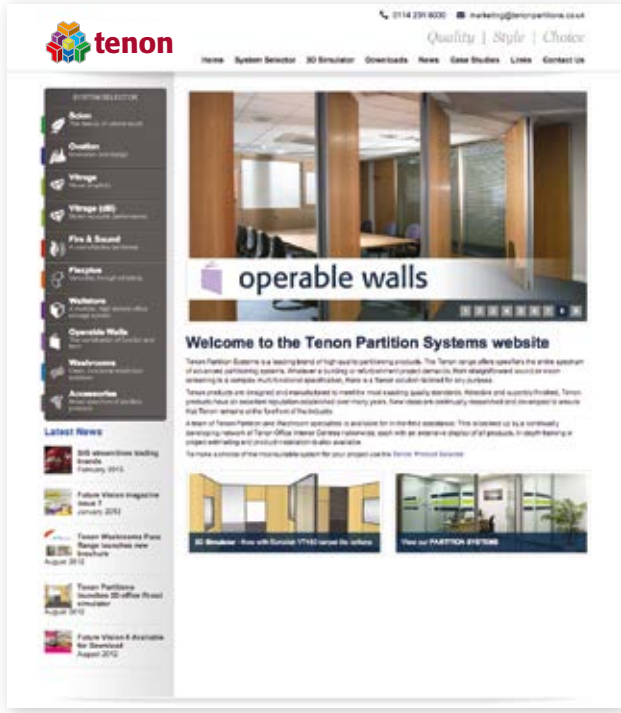

Turn your Vision into Reality

To make a choice of the most suitable system for your project use the Tenon Product Selector

tenon solutions across the spectrum	Board Rooms	Executive Office Suites	Reception Areas	Conference Suites	General Office Areas	Durable Surfaces	Washrooms
flexplus					✓	✓	
fire & sound	✓	✓		✓	✓	✓	
vitrage	✓	✓	✓	✓	✓		
scion	✓	✓	✓	✓	✓		
audientis	✓	✓	✓		✓	✓	
washrooms						✓	✓
operable walls	✓	✓		✓		✓	
wall store	✓	✓	✓	✓	✓	✓	



flexplus tenon

Suitable for:

- General Office Areas
- Durable Surfaces

Flexplus

Tenon Flexplus provides a cost effective and versatile range of partitioning for use in office environments where a simple, practical office divide is required.

The system is constructed from a range of aluminium upright posts and gypsum plasterboard faced honeycomb panels and is fully demountable and re-locatable.

Available in both single and double glazed formats, Flexplus can accommodate 15mm and 25mm integral venetian blinds and may be supplied in a silver anodised finish or a range of seventeen standard colours.

Based around a standard module width of 1200mm, Flexplus can be used to create partitions from barrier height up to 6000mm.

Tenon Flexplus is a fully demountable and re-locatable multi-purpose aluminium partition system that is simple and quick to install.

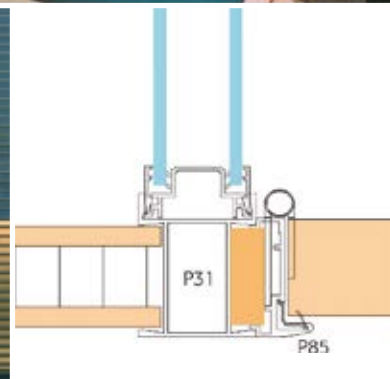

Lincoln

A standard Flexplus installation including doors with DDA compliant vision panels. Solid-glass-solid elevations comprising double glazed units with coordinated 25mm integral slat blinds.



Northampton

Full height single glazed Flexplus with DDA compliant manifestation and fitted optional timber skirting. Doors with DDA compliant vision panels and external kick plates.



Milton Keynes

Full height, single glazed powder coated aluminium Flexplus system with horizontal transom break detail at door head height. Oak doors with DDA compliant vision panels and lever sash locks with roundbar handles. 135° angled corner posts and 3 way detail combining glazing and solid modules. Solid module adjoining wall store. Black laminate skirting detail and customers own design of manifestation.





fire & sound

Suitable for:

- Board Rooms
- Executive Office Suites
- Conference Suites
- General Office Areas

Fire & Sound

Tenon Fire & Sound is a highly versatile demountable and re-locatable office partition system designed for use in both general office and light industrial areas and is constructed from steel, aluminium and plastic profiles together with plasterboard panels.

The system offers a high degree of choice in design options coupled with high performance and aesthetics in both single and double glazed formats.

Based on a standard module width of 1200mm. Construction height is determined by the choice of upright framing sections and module type, reaching a maximum height of 3000mm using standard components.

Constructed around a galvanised steel internal sub frame, the aluminium framing sections are available in a silver anodised finish, or in a range of seventeen standard colours.

Tenon Fire & Sound is well established as one of the most popular performance partition systems available.

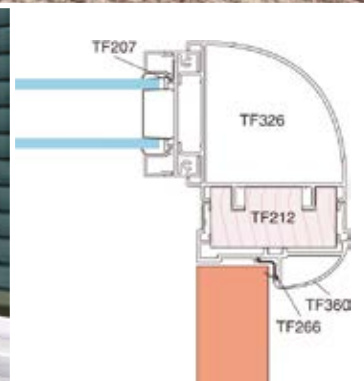

Northampton

77mm Fire & Sound – built freestanding with a suspended ceiling on a primary grid. Steel faced panels below transom line on front elevation. Double door complete with compliant vision panels. Glazing is Pyroshield for security.



Manchester

77mm Fire & Sound with part height banded manifestation and Vitrage (dB) with in-line dry joints. Aluminium door frames with full height glass doors on latched ironmongery.



Cambridge

Top solid 102mm Fire & Sound with latching glass door and part height bespoke manifestation.





vitrage tenon

Suitable for:

- Board Rooms
- Executive Office Suites
- Reception Areas
- Conference Suites
- General Office Areas

Vitrage & Vitrage (dB)

Tenon Vitrage is a glazed partition system that combines function with the clear, aesthetic benefits of dry joint glazing. Using a minimum number of aluminium framing sections, Vitrage provides an office divide that allows unhindered vision while still maintaining the privacy of individual offices.

Using either 10mm or 12mm toughened glass, depending on the height of the partition, flush glazing is achieved with the use of new Tenon crystal clear glazing gaskets that offer a modern alternative to traditional silicon jointing.

Vertical dry joints maintain the visual simplicity of the product, whilst offering a single or double glazed option or a combination of both.

To maintain the open feel of the product, frameless doors are fitted within the system using floor pivots, patch fittings, floor springs & sliding door gear. If standard timber veneered doors are required these are accommodated within standard Tenon Fire & Sound 77mm doorframe profiles, which are designed to be compatible with all Vitrage sections.

A partition system that combines function with the clear, aesthetic benefits of dry joint glazing.

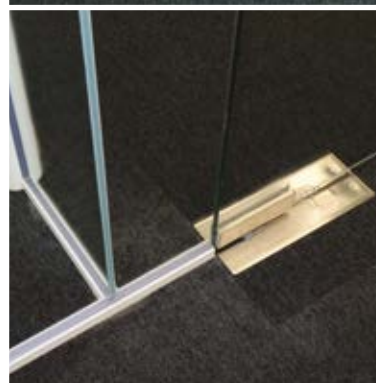

Loughborough

Single glazed Vitrage with in-line dry joints and DDA compliant manifestation.



Durham

Single glazed Vitrage with corporate manifestation. Glass double door set with back to back full height 'D' handles. Radius (curved) head detail.



Twickenham

Vitrage (dB) with reverse cut manifestation & system logo. 180° in-line dry joints and 135° corner detail. Double glazed door with integral blinds in a 77mm Fire & Sound door frame. Cranked 'D' handle, lock on heel spring and overhead door closer.





scion tenon

Suitable for:

- Board Rooms
- Executive Office Suites
- Reception Areas
- Conference Suites
- General Office Areas

Scion

Tenon Scion combines the visual appeal and luxurious finish of natural wood with the flexibility and performance of a contemporary partition system.

The system is ideal for use in boardrooms and executive areas, but also affords a practical and durable solution for general office areas. Scion is manufactured from solid timber using an attractive range of sustainable hardwoods and other suitable timbers, allowing endless design and build options.

Built to a patented method of construction, Scion is simple to install whilst still meeting the most demanding of design briefs. Available in single and double glazed formats, the system can incorporate silicone glazing and integral venetian blinds.

To complement and enhance the appearance of the product, a full array of Tenon door and joinery products is available together with a comprehensive range of ironmongery.

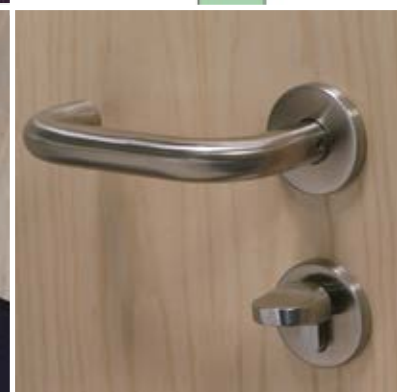
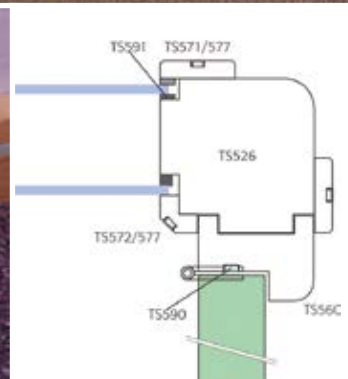

Warrington

Full height, single glazed Ash Scion with hospital door set to corridor.



Sheffield

Scion in Cherry with full height doors. Full height, double glazed with banded manifestation and end post detail.



London

Full height silicon jointed Oak Scion in bespoke single glazed profiles with full height locking glass doors on heel springs and top pivots. Standard three-way junctions leading into solid elevations.

Oak Wallstore – see page 19 for details.





audientis tenon

Suitable for:

- Board Rooms
- Executive Office Suites
- Reception Areas
- General Office Areas

Audientis

Tenon Audientis is a purpose made solution which combines creativity, flexibility and style to provide a perfect working environment with the added benefit of rapid on site installation.

Audientis's styling provides gently radiused upright posts and door frames with a choice of recessed or flush skirting. Standard module widths are 1209mm. Double glazed elements include an innovative integral transom feature providing a cost effective option to standard banded glazing.

An almost unlimited choice of RAL or BS colour finishes offer the potential to tailor installations to suit any corporate environment. Innovative bi-element construction allows rapid on-site assembly without lengthy lead times. Audientis is fully demountable and re-locatable thanks to the push-fit interpanel trims.

Creative use of Audientis provides the building blocks for today's discerning client.

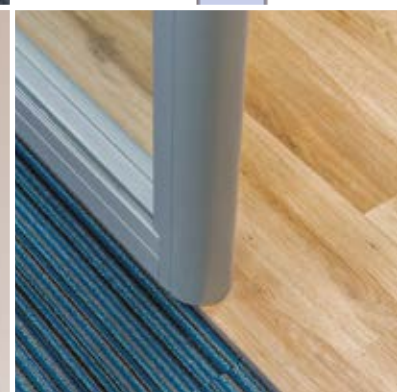
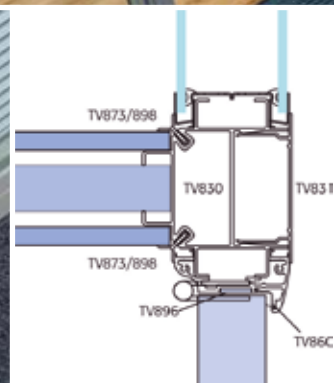

Bedford

Full height double glazed Audientis incorporating banded transom detail.



Lincoln

Double glazed banded transom Audientis with angled corner posts and fair end capping.



Warrington

Full height double glazed Audientis with banded glazing and flush fit skirting. Full height door on latching ironmongery. (Recessed skirting detail available as a customer option).





tenon washrooms

Clean functional washroom solutions

Suitable for:

- Washrooms

Washrooms

Tenon Washroom Systems provide a range of products that offers a solution to all washroom design briefs and budgets. Designed for speedy and easy installation, all washrooms products are supplied ready for immediate fitting and come complete with all the necessary fixtures and fittings.

Commercial: High quality systems designed for office applications including solutions for prestigious spaces.

Directors Suites: Creating areas of excellent aesthetics through a wide choice of luxury finishes and stainless steel accessories.

Education: Designed with children in mind - bright colours and manufactured from durable materials to prevent vandalism, there is a Tenon Washrooms solution for any installation.

Healthcare: Washroom ranges for use in healthcare environments where levels of hygiene are paramount for peace of mind

Leisure: Specifically designed to provide high performance incorporating resistance to water, high humidity, and sudden temperature change

Off the Shelf - Pace: A series of simple to install One-Size-Fits-All packs. Combine packs to create washroom system to meet all types of project. Pace can be installed by one person and trimmed in-situ to match site conditions.

Retail: Washroom solutions to meet the demands of any corporate or company branding.

Other washroom systems are available; please contact your local SIG Interiors stockist for details.

Cubicles can be tailor made to fit any situation, in an extensive choice of finishes.



Hammersmith

Tenon Washrooms Premier Plus range of toilet cubicles, vanity units and showers in Solid Grade laminate. Extruded aluminium headrail and a robust, full length door hinge extrusion.



Lambeth

Tenon Washrooms Premier One range. Solid Grade Laminate lockable duct sets and Wallgate hand wash units to replace the traditional basins.



Gatwick

Modular3 HPL washroom range with Misty Grey metal pilasters and Alpine Cherry laminate. Corian "Monte Blank" vanity tops with under slung basins. Dart Valley Sensor taps have been used as a water saving device.





operable walls

tenon

Suitable for:

- Board Rooms
- Executive Office Suites
- Conference Suites

Operable Walls

The Tenon Operable Wall range offers an unrivalled choice of quality engineered moveable partitions that provide effective space management.

Designed to suit all applications and budgets, the range is particularly suited for use in areas where flexibility and performance are equally as important, for instance:

- › Office interiors and meeting rooms
- › Conference and function suites
- › Sports and leisure facilities
- › Education establishments
- › Exhibition centres

The range includes:

- Silenta** High specification, top hung moveable wall
- Compacta** Hinged panelled sliding wall system
- Observa** Fully glazed for a fresh modern feel
- Consertina** Speedy and cost effective room division

Operable walls for an effective & flexible solution to dividing space.

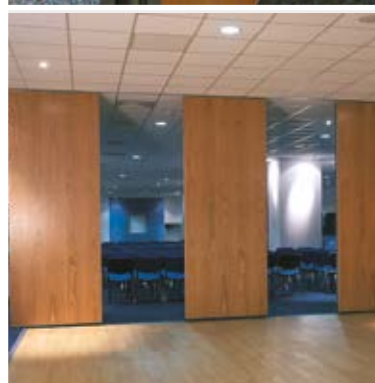



wall store tenon

Suitable for:

- Board Rooms
- Executive Office Suites
- Reception Areas
- Conference Suites
- General Office Areas
- Durable Surfaces

Wall Store

Tenon Wall Store is a simple but very effective concept, which utilises ceiling height modular units to provide an integrated wall and storage partition.

The system provides compact and streamlined storage which can be used as both free standing room dividers or as partition walls for cellular offices. It has been designed to integrate with and to complement the complete range of Tenon partitioning systems.

Demountable and re-locatable, Tenon Wall Store is an ideal solution for high density storage, as it optimises the space normally wasted above traditional freestanding units. The resultant saving in rent and rate costs can be considerable.

A wide choice of internal fittings are available, offering extensive permutations, from high density filing to audio-visual presentation systems.

Fully demountable and re-locatable, providing versatile, compact and streamlined storage.

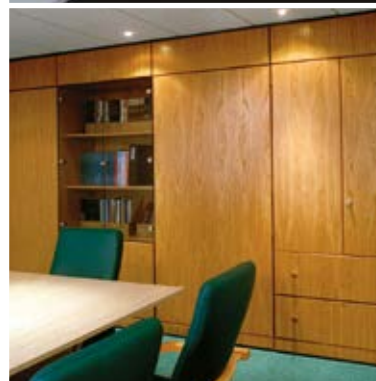



doors & ironmongery

Doors & Ironmongery

Quality doors and ironmongery items to complement the entire Tenon range.

Standard Timber Doors

Door blanks are available in either cellular or solid core along with coordinated timber frames, vision panels and veneer options depending on specification. These are held in stock for next day delivery.

- Full height and door/overpanels options
- Door re-sizing
- Incorporation of non-standard glazed vision panels
- Fire rating to meet FD30 or FD60 requirements
- Fully compliant with DDA regulations

Bespoke Doors

Custom made doors are also available to meet specific project or client requirements. To enhance the natural features of the product, Tenon doors are supplied fully finished with a machine applied UV stable, clear lacquer, applied during manufacture. Bespoke Tenon doors can accommodate a full range of veneers and include vision apertures in a variety of shapes, precision cut with a CNC router for superb accuracy plus:

- Fully finished non-standard door sizes
- Bespoke vision panels
- Range of non-standard speciality veneers
- Range of laminate finishes
- Pre-primed ply faced paint grade doors

Also available;

- Double and Hospital door-sets
- Overpanels with matching grain
- Your choice of vision panel design
- CPL Faced doors

Single & Double Glazed Doors

Designed to be incorporated in the Vitrage silicone glazed system, both the single glass and the newly introduced double glazed doors can also be incorporated within other Tenon systems to give specifiers endless design options. The Vitrage (dB) system now offers a new double glazed door giving ultimate performance and design flexibility.

Ironmongery

A wide range of standard and specialist door furniture is available to suit any design or performance criteria in a variety of finishes, for any Tenon system.





doors & door veneers

This colour guide represents the Standard Door Veneers available from stock at Tenon stockists.

Other non-standard colours are available on extended lead times and at an additional cost.

- American Ash
- American Cherry
- American White Oak
- Maple
- Sapele
- Steamed Beech
- Walnut

Door Veneers Chart

American Ash



American Cherry



American White Oak



Maple



Sapele



Steamed Beech



Walnut



Please note: Every effort has been made to give a true representation of the door veneers shown, unfortunately Tenon cannot guarantee 100% accuracy of the finishes due to the constraints of the printing process



glass, blinds & manifestation

Glass, Blinds & Manifestation

Glass, Blinds and a wide range of Manifestation are available to finish any Tenon project.

The following types of glass and services are available;

- **Laminated & Toughened safety glass - Pyroshield (GWPP) and clear fire glass**
- **Toughened glass for silicone glazing - Security glass - Anti bandit, bullet-resistant**
- **Window film application (includes graphics) - Insulating and fire rated glass**
- **Acoustic performance glass - Acid etching - Tinted glass**

The following types of venetian blinds and services are available;

- **25mm Venetian blinds – 15mm micro blinds – Site survey required**
- **Wide choice of colours in plain & perforated slats available**
- **Manual and Electrically/Remote operated blind control kits**
- **Alternatively, Building Regulations compliant film applied manifestation allows for personalised designs and corporate logos**





tenon

colour reference chart

This colour guide represents the Standard range of RAL and British Standard colours available from Tenon stockists.

RAL Colours	British Standard colours
• 5003	• 00A01
• 5010	• 00A05
• 5012	• 00B15
• 5014	• 00B29
• 6005	• 00E53
• 7011	
• 7016	
• 7035	
• 9006	
• 9010	
• 9016	

Other non-standard colours are available on extended lead times and at an additional cost.

British Standard Colours

BS: 00A01 Ash Grey
BS: 00A05 Goose Grey
BS: 00B15 Magnolia
BS: 00B29 Van Dyke Brown
BS: 00E53 Poppy Red

RAL Colours

RAL 5003 Dark Sapphire Blue
RAL 5010 Gentian Blue
RAL 5012 Light Blue
RAL 5014 Pigeon Blue
RAL 6005 Moss Green
RAL 7011 Iron Grey
RAL 7016 Anthracite Grey
RAL 7035 Pale Grey
RAL 9005 Jet Black
RAL 9006 Silver
RAL 9010 Pure White
RAL 9016 Traffic White

Please note:

Every effort has been made to give a true representation of the door colours shown, unfortunately Tenon cannot guarantee 100% accuracy of the finishes due to the constraints of the printing process

Exclusive stockists of Tenon Partition Systems:



Scotland

Glasgow
21 Dava Street,
Glasgow,
G51 2JA
Tel: 0141 440 6960
Fax: 0141 440 6961

Tyneside

Gateshead
Unit A389,
Western Avenue,
Team Valley Trading Estate,
Gateshead, Tyne & Wear,
NE11 0SZ
Tel: 0191 482 4211
Fax: 0191 482 3500

North West

Liverpool
Horn House Lane,
Knowsley Industrial Park,
Liverpool, L33 7YQ
Tel: 0151 547 5288
Fax: 0151 547 5299

Manchester
8 Commerce Way,
Kiwi Park, Trafford Park,
Manchester, M17 1HW
Tel: 0161 874 5311
Fax: 0161 874 5312

North East

Leeds
Unit 3,
Elland Road Industrial Park,
Elland Way, Elland Road,
Leeds, LS11 0EY
Tel: 0113 270 0333
Fax: 0113 270 2839

Sheffield
Nunnery Drive,
Sheffield, S2 1TA
Tel: 0114 2317 317
Fax: 0114 2317 318

Midlands

Birmingham
85 Chester Street,
Aston, Birmingham, B6 4AE
Tel: 0121 380 1600
Fax: 0121 380 1616

Leicester
Unit E, Braunstone Industrial Estate,
139 Scudamore Road,
Leicester, LE3 1UQ
Tel: 0116 255 1585
Fax: 0116 255 1745

Nottingham
Unit 3,
Cossall Industrial Estate,
Coronation Road,
Ilkeston, DE7 5UA
Tel: 0115 944 1359
Fax: 0115 930 9249

Birmingham
(West Bromwich),
Unit A, Halfords Park,
Halfords Lane, Smethwick,
Birmingham, B66 1EL
Tel: 0121 565 5700
Fax: 0121 558 3233

Anglia

Bedford
Telford Way, Bedford,
MK42 0PQ
Tel: 01234 761112
Fax: 01234 343584

Luton
Units 11-12,
Stadium Industrial Estate,
Cradock Road,
Luton, LU4 0JF
Tel: 01582 594222
Fax: 01582 595222

Norwich
Unit 27,
White Lodge Business Park,
Hall Road,
Norwich, NR4 6DG
Tel: 01603 766471
Fax: 01603 764685

London

London East - Croydon
Unit 1 Beddington Lane
Industrial Estate,
115-135 Beddington Lane,
Croydon, CR0 4TS
Tel: 020 8684 7775
Fax: 020 8684 0982

London East - Edmonton
Unit 14A,
Banksia Road,
Edmonton, London,
N18 3BF
Tel: 020 8884 3444
Fax: 020 8884 5471

London West - Southwark
Unit 6,
Bricklayers Arms,
Distribution Centre,
Mandela Way,
London, SE1 5SR
Tel: 020 7064 4900
Fax: 020 7064 4919

London East - Barking
Unit 1, New England Estate,
Gascoigne Road, Barking,
London, IG11 7NZ
Tel: 020 8477 9499
Fax: 020 8591 0351

London West - Twickenham
Twickenham Trading Estate,
Rugby Road, Twickenham,
TW1 1DQ
Tel: 020 8891 5971
Fax: 020 8892 5218

South West

Bristol
Unit 200, North Bristol Park,
North Way, Filton,
Bristol, BS34 7QH
Tel: 0117 931 3432
Fax: 0117 931 3433

Cardiff
Units H&J, Southpoint Ind Est,
Clos Marian,
Cardiff, CF10 4SP
Tel: 029 2047 4787
Fax: 029 2047 4797

Plymouth
87 St Modwen Road,
Parkway Industrial Estate,
Marsh Mills, Plymouth
Devon, PL6 8LH
Tel: 01752 675414
Fax: 01752 675413

South East

Brighton
Lancing Unit 1,
Lancing Business Park,
Chartwell Road,
Lancing, West Sussex,
BN15 8TU
Tel: 01903 218115
Fax: 01903 823298

Heathrow
Blackthorne Road,
Poyle Trading Estate,
Colnbrook,
Slough, SL3 0DU
Tel: 01753 691818
Fax: 01753 694485

Maidstone
Unit 5 Larkfield Mill,
Bellingham Way,
Larkfield, Aylesford,
Kent, ME20 6SQ
Tel: 01622 791100
Fax: 01622 791375

Oxford
Unit 5 Curbridge Business
Park, Downs Road,
Witney, Oxon,
OX29 7WJ
Tel: 01993 700993
Fax: 01993 708993

Portsmouth
Unit 2 Quadra,
Sharps Close,
Portsmouth
PO3 5PS
Tel: 02392 696733
Fax: 02392 661406

Southampton
Unit 41a Oriana Way,
Nursling Industrial Estate,
Southampton,
SO16 0YU
Tel: 023 8074 3799
Fax: 023 8074 3948



tenon

Quality | Style | Choice

www.tenonpartitions.co.uk

Hillsborough Works, Langsett Road, Sheffield, S6 2LW
Tel: 0114 231 8030 Fax: 0114 231 8031



© Tenon Partitions. A product of



ns5Plus