

teknion community table



a model of simple design, that is about people

OVERVIEW

Designed for Teknion by Michael Vanderbyl, the Community Table is a model of simple, straightforward design, with substantial proportions to act as a focus for the space. It is an architectural anchor that invites people to gather and indulge in deeper social and work interactions.

Access to power/data is transparent, provided via a central trough. The finishes and dimensions of the table can be customized to meet clients' exact requirements. Minimal and yet warm, this well-crafted wood table is ideal for the new human-centered workplace, one that references the domestic environment; one that is informal and collaborative.

OFFERING

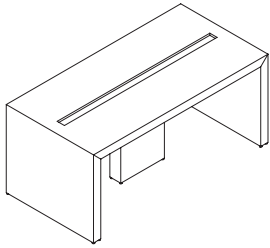
- Bar & Counter Heights
- Sizes ranges: 96 to 216 inches
- Finishes include standard Teknion Veneer 4 and Flintwood
- Specialty finishes available by request

OPTIONS

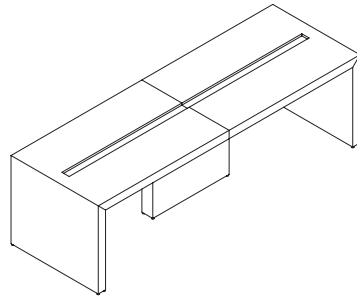
- Electrical Outlets with Power and USB
- Integrated TV Lift, includes lifting mechanism & remote

TABLE SECTIONS

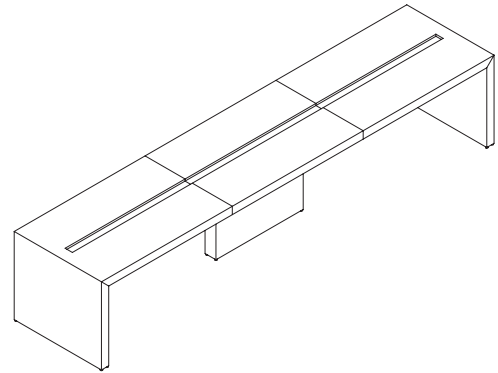
The Community Table comes in one to three sections depending on the width.



96" Width will have One Table Section



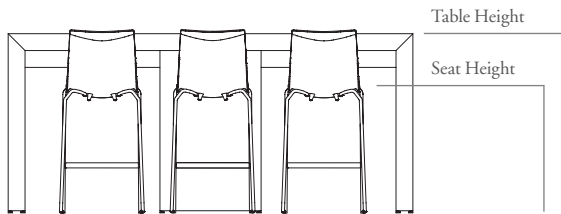
120" - 144" Widths will have Two Table Sections



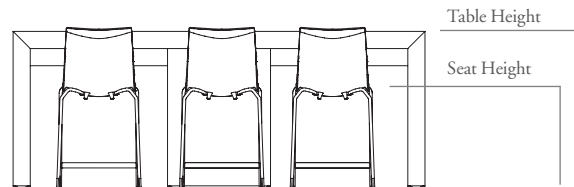
168" - 216" Widths will have Three Table Sections

RECOMMENDED SEAT HEIGHTS

The Worksurface and End Panels have a 4" thickness. Subtract 4" from the overall height to determine the clearance under the worksurface.



Seat height for 42" Bar height table is 30"



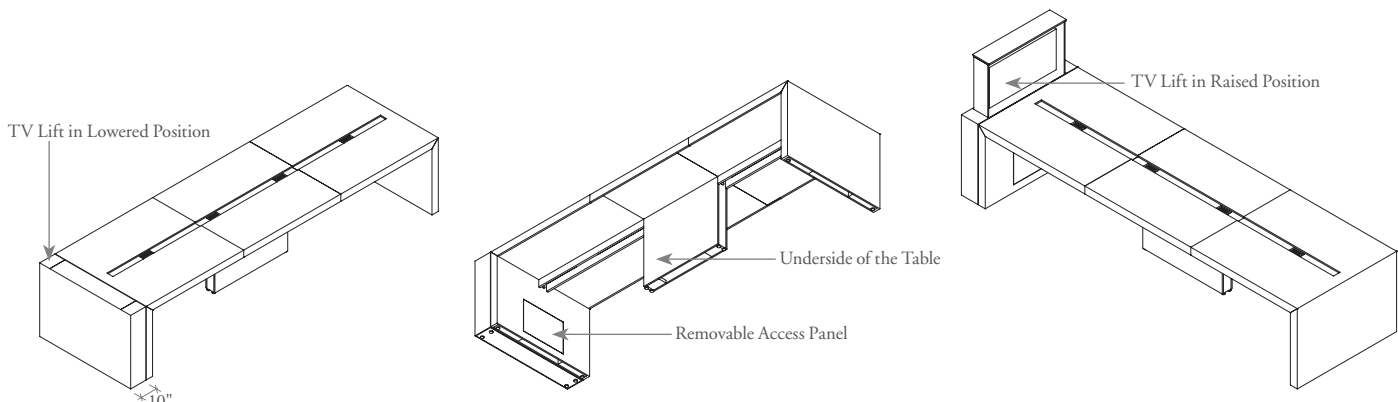
Seat height for 36" counter height table is 24"

TV LIFT OPTION

The TV Lift provides convenience access to technology while collaborating and is hidden seamlessly within the table when not in use. When the option is selected, one of the Electrical Outlets will include a HDMI Connector.

*This option is not available for 36" depths and does not include the TV or TV Mounting bracketry hardware.

*The TV dimensions should not exceed an overall height of 25-1/2", a width of 41" for 48" table depths, or a width of 43-1/2" for 60" table depths.



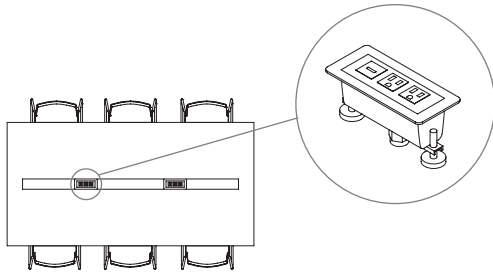
Installed at one end of the table and will add 10" to the overall table width.

Includes access panel in the base, lift mechanism and remote

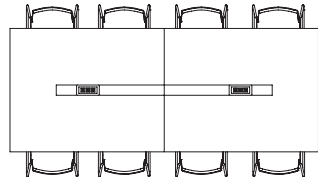


TABLE OCCUPANCY

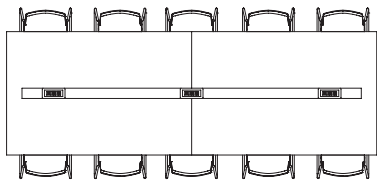
The following demonstrates the maximum table occupancy to allow for adequate personal and working space.



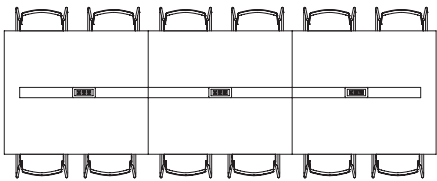
96" wide
6 seats maximum



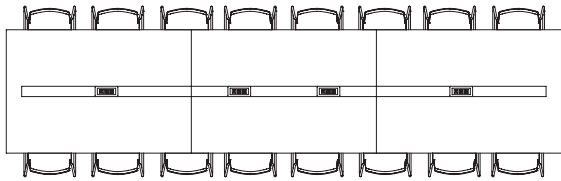
120" wide
8 seats maximum



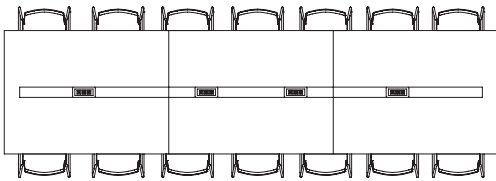
144" wide
10 seats maximum



168" wide
12 seats maximum



216" wide
16 seats maximum



192" wide
14 seats maximum

.....



COMMUNITY TABLE CATALOG (CWCT) PRICING

Height	Width	# of Table Sections	# of Power/USB Modules (if specified)	Price	Price	Price
				36" Depth Flintwood / Veneer Finish	48" Depth Flintwood / Veneer Finish	60" Depth Flintwood / Veneer Finish
36"	96"	1	2	\$26,197 / \$26,880	\$28,254 / \$29,048	n/a
36"	120"	2	2	\$31,680 / \$32,425	\$34,941 / \$35,814	\$37,129 / \$38,129
36"	144"	2	3	n/a	\$37,012 / \$37,988	\$39,357 / \$40,474
36"	168"	3	3	n/a	\$43,920 / \$45,025	\$47,023 / \$48,189
36"	192"	3	4	n/a	\$46,137 / \$47,338	\$49,285 / \$50,671
36"	216"	3	4	n/a	\$49,640 / \$50,936	\$51,581 / \$52,872
42"	96"	1	2	\$26,771 / \$27,493	\$28,881 / \$29,721	n/a
42"	120"	2	2	\$32,255 / \$33,040	\$35,567 / \$36,488	\$37,807 / \$38,862
42"	144"	2	3	n/a	\$37,637 / \$38,662	\$40,033 / \$41,207
42"	168"	3	3	n/a	\$44,549 / \$45,692	\$47,607 / \$48,921
42"	192"	3	4	n/a	\$46,762 / \$48,016	\$49,905 / \$51,344
42"	216"	3	4	n/a	\$50,269 / \$51,613	\$52,258 / \$53,607

Electrical Outlets with Power and USB are \$709 each. When specified, the number of modules included is noted above.

TV Lift Option for 36" Height tables is \$13,431 for 48" depths and \$13,922 for 60" depths

TV Lift Option for 42" Height tables is \$13,650 for 48" depths and \$14,195 for 60" depths

Not available in Cathedral grain Flintwood finishes