

PLASTESTRIP PROFILES

PlastiClad



2008

CATALOGUE

Lead Times

Orders placed before 1PM for items that are available in stock can be despatched same day for delivery within 1-3 days.

Regarding Plastestrip stocking policy, we request you study the following carefully:

Fixings

Standard Colours Generally held in stock, however, if item is not available a lead-time must be allowed for.

RP8 Screws Allow up to 3 weeks

RP12 Screws Allow up to 3 weeks

RP42 Allow up to 3 weeks.

RP/FIX/20 Allow up to 3 weeks.

RP/STEEL/25 Allow up to 3 weeks.

861232 Allow up to 3 weeks.

871240 Allow up to 3 weeks.

RIVET/18 Allow up to 3 weeks

RIVET/23 Allow up to 6 weeks.

893615 Allow up to 3 weeks.

864134 Allow up to 3 weeks.

864559 Allow up to 3 weeks.

Non Standard Colours Limited numbers are held in stock, however, if item is not available a lead-time must be allowed for.

RP8 Screws Allow up to 3 weeks

RP/FIX/20 Allow up to 3 weeks.

RP/STEEL/25 Allow up to 3 weeks.

861232 Allow up to 3 weeks.

871240 Allow up to 3 weeks.

RIVET/18 Allow up to 3 weeks.

RIVET/23 Allow up to 6 weeks.

RIVET/119 Allow up to 6 weeks

RIVET/124 Allow up to 6 weeks

864134 Allow up to 3 weeks.

864559 Allow up to 3 weeks.

RAL Design All fixing types, allow 6-8 weeks.

Gaskets

Generally black is held in stock, however, if at time of order the item is not available a lead-time of 7-10 days must be allowed for.

Profiles

Standard and non Standard Colours

PVC Generally RAL 9010, 9005, 1013, 1015, 7035, 7031 and 8028 are held in stock, however, if at time of order the item is not available a lead-time of 2-3 weeks must be allowed for.

Aluminium Generally Silver Anodised, 9010 and 9005 are held in stock, however, if at time of order the item is not available a lead time of 3-9 weeks must be allowed for.

RAL Design

PVC Not available

Aluminium-Allow 8-12 weeks

Structural Adhesives

Rockpanel Tack and Sikatack

Generally the system is held in stock, however, if at time of order any item is not available a lead-time of up to 2 weeks must be allowed for.

FastFrame

FastFrame Generally the system is held in stock, however, if at time of order any item is available stock a lead-time of 3 weeks must be allowed for. This is dependant on quantity and bracket size.

Remember to always check availability before you order.

To avoid availability issues and delays on site, consult Plastestrip as early as possible into the project programme. Plastestrip is happy to organise and reserve materials to meet agreed delivery schedules. By providing this information it helps us to help you.

Profile Standard Colours are defined as:

RAL1013, RAL1015, RAL3004, RAL3007, RAL3009, RAL5011, RAL6009, RAL7001, RAL7004, RAL7016, RAL7021, RAL7022, RAL7030, RAL7031, RAL7035, RAL7037, RAL8028, RAL9001, RAL 9005 and RAL 9010

Fixing Standard Colours are defined as:

Any plain colour from the RAL, BS or NCS colour charts, colour-matching service available.

Steni Stoneflex Colours are defined as:

Bermuda white, Boston Brick, French Rouget, Indian Ivory, Java Grey, Nordic Spar, Sahara Beige, Smokey Mountain, Swedish Green, Mexican Pink.

Northern Sales Manager

Graham Pugh
Tel: 07968 377421
Email: graham@plastestrip.com
Area marked in white on map

Southern Sales Manager

Mark Henderson
Tel: 07971 316421
Email: mark@plastestrip.com
Areas marked in grey on map

Cumbria
Derbyshire
Dumfries and Galloway
Durham
Dyfed
Fife
Grampian
Greater Manchester
Gwent
Gwynedd County
Highlands and Islands
Humberside
Lancashire
Leicestershire
Lincolnshire
Lothian
Merseyside
Mid Glamorgan
North Yorkshire
Northern Ireland
Northumberland
Nottinghamshire
Powys
Republic of Ireland
Rutland
Shropshire
South Glamorgan
South Yorkshire
Staffordshire
Strathclyde
Tayside
Tyne and Wear
West Glamorgan
West Yorkshire

Avon
Bedfordshire
Berkshire
Buckinghamshire
Cambridgeshire
Cornwall
Devon
Dorset
East Sussex
Essex
Gloucestershire
Greater London
Hampshire
Herefordshire
Hertfordshire
Isle of Wight
Kent
Middlesex
Norfolk
Northamptonshire
Oxfordshire
Somerset
Suffolk
Surrey
Warwickshire
West Midlands
West Sussex
Wiltshire

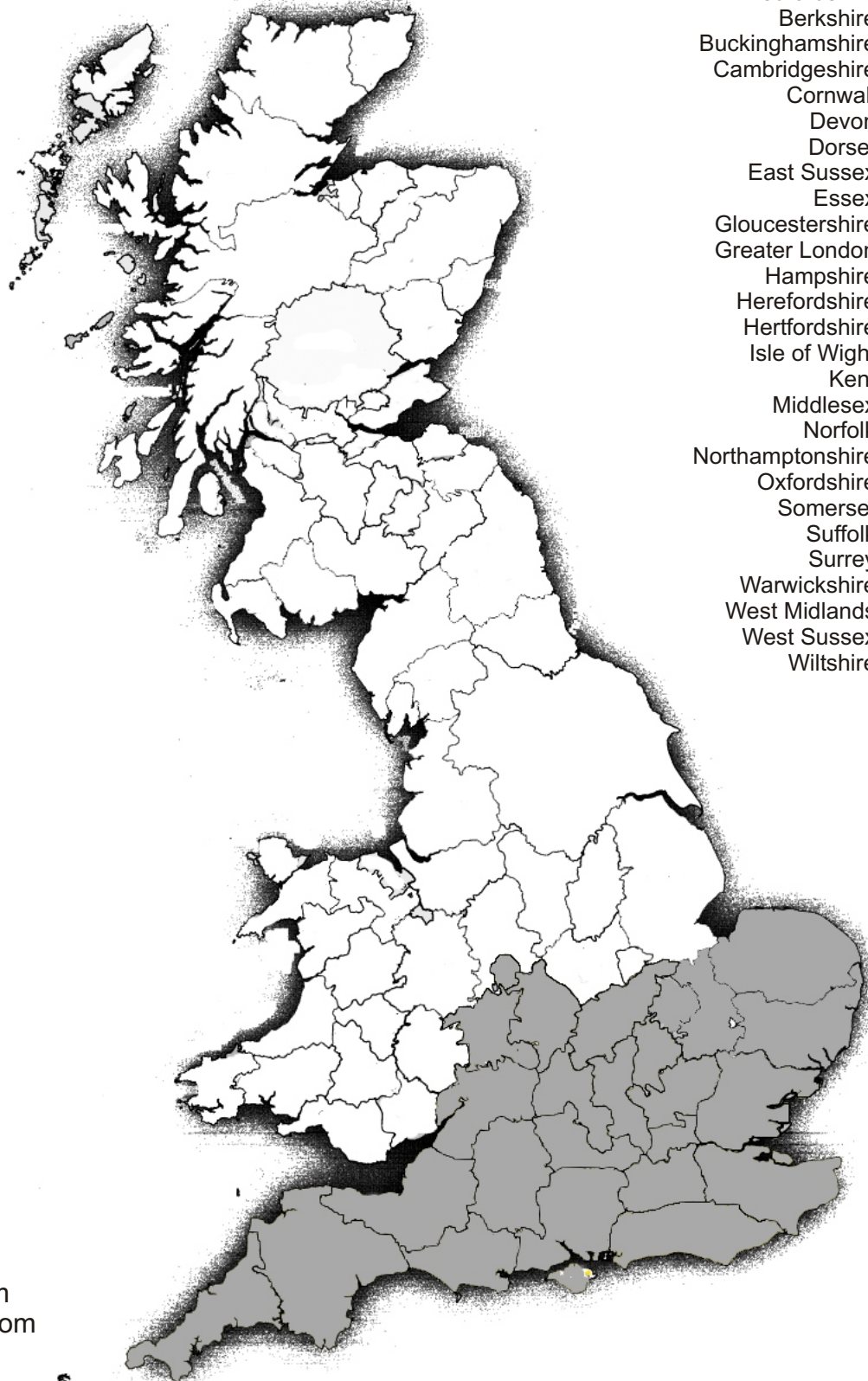

Head Office

Plastestrip Profiles
1 Enterprise Park
St Austell
PL25 4EJ
Tel: 01726 74771
Fax: 01726 69238
www.plastestrip.com
sales@plastestrip.com

Contents

PLASTIC PROFILES

FLEXIBLE GASKETS PROFILES	1
SHADOW LINE TAPE	1
RIGID PVC EXTERNAL CORNER PROFILES	1
PVC EXTERNAL CORNER PROFILES	1
PVC INTERNAL CORNER PROFILES	1
PVC EDGE FINISHING PROFILES	1 - 2
PVC VERTICAL JOINING PROFILES	2
PVC HORIZONTAL SHADOW GAP PROFILES	2
PVC TOP RAIN DRIP PROFILES	3
PVC BOTTOM RAIN DRIP PROFILES	3
PVC HEAD & SIDE CLOSER PROFILES	3
PVC VENTILATION PROFILES	3

ALUMINIUM PROFILES

ALUMINIUM PREFORMED SPECIALS	3
ALUMINIUM EXTERNAL CORNER PROFILES	4
ALUMINIUM INTERNAL CORNER PROFILES	4
ALUMINIUM JOINT PROFILES	4
ALUMINIUM VERTICAL JOINING PROFILES	4
ALUMINIUM HORIZONTAL JOINING PROFILES	4
ALUMINIUM DRIP PROFILES	4 - 5
ALUMINIUM EDGE FINISHING PROFILES	5
ALUMINIUM STARTER TRIM	5
ALUMINIUM VENTILATION PROFILES	5

ACCESSORIES

ROCKPANEL EASYFIX SIDINGS	5
TOOLS & ACCESSORIES	5

PLASTIBREATHE

CLADDING MEMBRANE	5
-------------------	---

FIXINGS

NAILS, RIVETS & SCREWS	6
------------------------	---

FACADE SUPPORT SYSTEM

ROCKPANEL TACK ADHESIVE	7
SIKA PANEL ADHESIVE	7
ALUMINIUM FACADE SUPPORT RAILS	7
ALUMINIUM SECRET FIX SYSTEM FOR HPL	7



ADJUSTABLE FACADE SUPPORT SYSTEM

FASTFRAME BRACKETS	8
FASTFRAME RAILS	8
FASTFRAME FIXINGS	8

PLASTICLAD CLADDING ACCESSORIES BY PLASTESTRIP

FLEXIBLE GASKET PROFILES

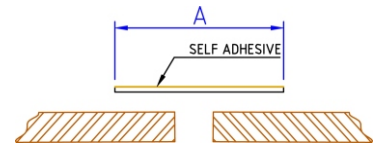
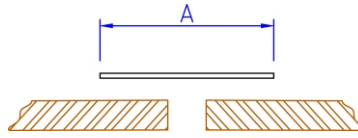
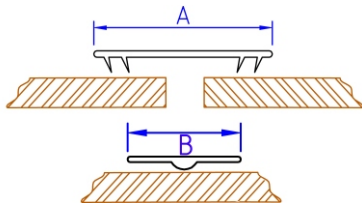

Ref	A (mm)	B (mm)	Suitable for	Ref	A (mm)	Suitable for	Ref	A (mm)	Suitable for
090/36P	36	-	Any board	055/36F	36	Any board	090/35N	35	Any board
090/60P	60	-	Any board	055/60F	60	Any board	090/49N	49	Any board
090/75P	75	-	Any board	055/75F	75	Any board	090/59N	59	Any board
090/100P	100	-	Any board	055/100F	100	Any board	090/79N	79	Any board
090/125P	125	-	Any board	055/125F	125	Any board	090/99N	99	Any board
090/16/INT	-	14.91	Any board						

25m Coils

25m Coils

25m Coils

COLOURS: BLACK & WHITE

COLOURS: BLACK & WHITE

COLOURS: BLACK & WHITE

SHADOW LINE TAPE

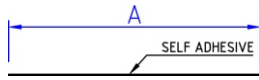

RIGID PVC EXTERNAL CORNER PROFILES

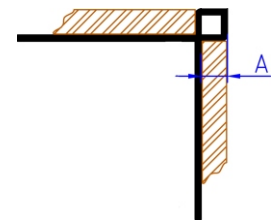
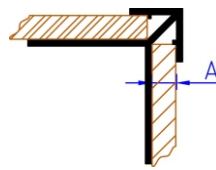

Ref	A (mm)	Suitable for	Ref	A (mm)	Suitable for	Ref	A (mm)	Suitable for
PVC/50/25	50	Any Board	006P	6.5	6mm Board	016P	6.5	6mm Board
			008P	8.5	8mm Board	018P	8.5	8mm Board
			001P	10.5	10mm Board	010P	10.5	10mm Board
			005P	12.5	12mm Board			
			009P	19.5	19mm Board			

33m ROLLS

3055mm LENGTHS

3055mm LENGTHS

COLOUR: BLACK

AVAILABLE IN STANDARD & NON STANDARD COLOURS

AVAILABLE IN STANDARD & NON STANDARD COLOURS

RIGID PVC EXTERNAL CORNER PROFILES

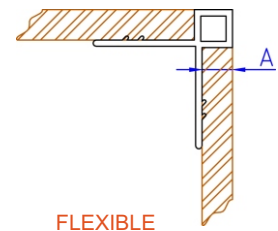
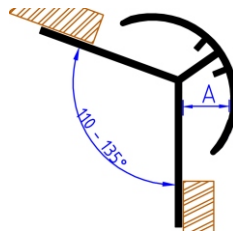
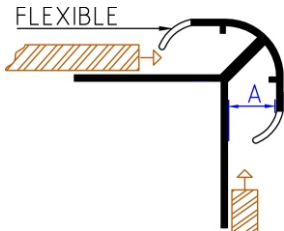

Ref	A (mm)	Suitable for	Ref	A (mm)	Suitable for	Ref	A (mm)	Suitable for
019/48P	9.25	5 - 9mm Board	099/59P	9.25	5 - 9mm Board	030/60F	6	6mm Board

3055mm LENGTHS

3055mm LENGTHS

12.5m Coils

AVAILABLE IN BLACK & WHITE

AVAILABLE IN STANDARD & NON STANDARD COLOURS

AVAILABLE IN B&W AND STENI STONEFLEX COLOURS

PVC INTERNAL CORNER PROFILES

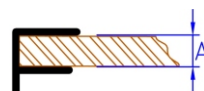
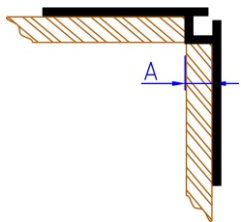

Can be used as a corner or edge profile

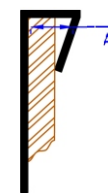

Ref	A (mm)	Suitable for	Ref	A (mm)	Suitable for	Ref	A (mm)	Suitable for
026P	6.5	6mm Board	EF/14	6.25	6mm Board	076P	6.5	6mm Board
028P	8.5	8mm Board	EF/38	9.25	8 - 9mm Board	078P	8.5	8mm Board
020P	10.5	10mm Board	EF/78	20.25	20mm Board	0710P	10.5	10mm Board
						0712P	12.5	12mm Board
						0719P	19.5	19mm Board

3055mm LENGTHS

3055mm LENGTHS

3055mm LENGTHS

AVAILABLE IN STANDARD & NON STANDARD COLOURS

AVAILABLE IN STANDARD & NON STANDARD COLOURS

AVAILABLE IN STANDARD & NON STANDARD COLOURS

CAD DRAWINGS AVAILABLE ON REQUEST

PLASTICLAD CLADDING ACCESSORIES BY PLASTESTRIP

PVC EDGE FINISHING PROFILES



Ref	A (mm)	Suitable for
ENCP/66	6.5	6mm Board
ENCP/88	8.5	8mm Board
ENCP/10	10.5	10mm Board
ENCP/12	12.5	12mm Board

3055mm Lengths

AVAILABLE IN STANDARD & NON STANDARD COLOURS

PVC VERTICAL JOINING PROFILES

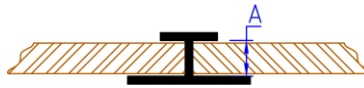

Ref	A (mm)	Suitable for
066P	6.5	6mm Board
068P	8.5	8mm Board
0610P	10.5	10mm Board
0612P	12.5	12mm Board

3055mm Lengths

AVAILABLE IN STANDARD & NON STANDARD COLOURS

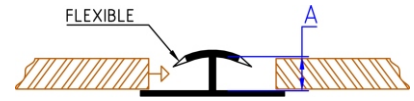

Ref	A (mm)	Suitable for
099/810P	10.75	9 - 10mm Board

3055mm Lengths

COLOURS: BLACK & WHITE

PVC VERTICAL JOINING PROFILES

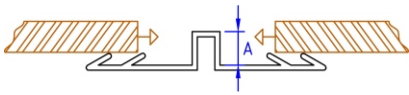

FLEXIBLE

Ref	A (mm)	Suitable for
070-66/WFS	6.5	6mm Board
070/88F	8.5	8mm Board

12.5m ROLLS

AVAILABLE IN B&W AND STENI STONEFLEX

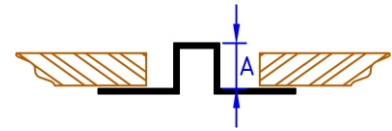

Ref	A (mm)	Suitable for
TH/SM/6/26	6.5	5 - 6mm Board
TH/LR/8/26	8.5	7 - 8mm Board

3055mm LENGTHS

AVAILABLE IN STANDARD & NON STANDARD COLOURS

PVC VERTICAL JOINING PROFILES

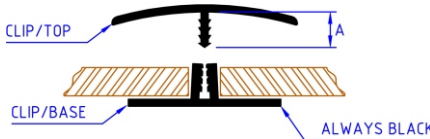

Ref	A (mm)	Suitable for
CLIP/TOP/6/8	5.5	6 - 8mm Board
CLIP/TOP/8/10	7.5	8 - 10mm Board
CLIP/SM/BASE	-	All tops

3055mm LENGTHS

AVAILABLE IN STANDARD & NON STANDARD COLOURS

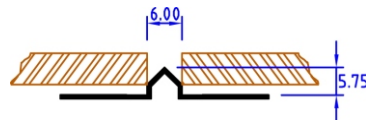

Ref	Suitable for
050/6G	Any Board

3055mm LENGTHS

AVAILABLE IN STANDARD & NON STANDARD COLOURS

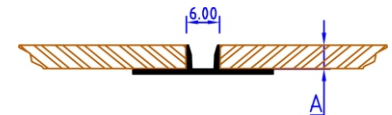

Ref	A (mm)	Suitable for
005/6G	6.5	6mm Board
078/6G	8.5	8mm Board
098/6G	10.5	10mm Board

3055mm LENGTHS

AVAILABLE IN STANDARD & NON STANDARD COLOURS

PVC HORIZONTAL SHADOW GAP PROFILES

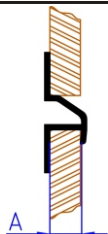

Ref	A (mm)	Suitable for
H/66J	6.5	6mm Board
H/88J	8.5	8mm Board
H/10J	10.5	10mm Board

3055mm Lengths

AVAILABLE IN STANDARD & NON STANDARD COLOURS

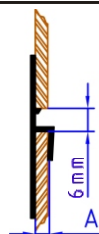

Ref	A (mm)	Suitable for
056P	6.5	6mm Board
058P	8.5	8mm Board

3055mm LENGTHS

AVAILABLE IN STANDARD & NON STANDARD COLOURS



Ref	A (mm)	Suitable for
PH/6.5	6.5	6mm Board
PH/8.5	8.5	8mm Board
PH/10.5	10.5	10mm Board
PH/13.5	13.5	13mm Board

3055mm LENGTHS

AVAILABLE IN STANDARD & NON STANDARD COLOURS

CAD DRAWINGS AVAILABLE ON REQUEST

PLASTICLAD CLADDING ACCESSORIES BY PLASTESTRIP

CAD DRAWINGS AVAILABLE ON REQUEST

PVC TOP RAIN DRIP PROFILES			PVC BOTTOM RAIN DRIP PROFILES			PVC HEAD AND SIDE CLOSER PROFILE			
Ref	A (mm)	Suitable for	Ref	A (mm)	Suitable for	Ref	A(mm)	B(mm)	Suitable for
RD/68 RD/91	7 10.25	6mm Board 8 - 10mm Board	086P 088P 0810P	6.5 8.5 10.5	6mm Board 8mm Board 10mm Board	PW/DRIP	37	32.75	Any Board
3055mm Lengths			3055mm Lengths			3055mm Lengths			
AVAILABLE IN STANDARD & NON STANDARD COLOURS			AVAILABLE IN STANDARD & NON STANDARD COLOURS			AVAILABLE IN STANDARD & NON STANDARD COLOURS			

PVC VENTILATION PROFILE												
Ref	A(mm)	B(mm)	C(mm)				Suitable for	Ref	A(mm)		B(mm)	C(mm)
025/10K 032/10K 038/10K 049/10K	25 25 25 25	25 32 38 50	20 25 25 25	Any Board Any Board Any Board Any Board				065/10K 090/25K 125/25K	30 55 55	35 38 69	65 90 125	Any Board Any Board Any Board
3055mm LENGTHS							3055mm LENGTHS					
AVAILABLE IN STANDARD & NON STANDARD COLOURS							AVAILABLE IN STANDARD & NON STANDARD COLOURS					

PVC VENTILATION PROFILE											
Ref	A(mm)	B(mm)	Suitable for	Ref	A(mm)	B(mm)	Suitable for	Ref	A(mm)		B(mm)
055/10K	36	60	6 - 8mm Board	088/25K	55	79	6 - 8mm Board	051/FLAT/VENT 061/FLAT/VENT 091/FLAT/VENT 126/FLAT/VENT	51 61 NA NA	NA NA 91 126	Any Board Any Board Any Board Any Board
3055mm LENGTHS				3055mm LENGTHS				10m ROLLS			
AVAILABLE IN STANDARD & NON STANDARD COLOURS				AVAILABLE IN STANDARD & NON STANDARD COLOURS				AVAILABLE IN STANDARD & NON STANDARD COLOURS			

ALUMINIUM PREFORMED SPECIALS



CAPPINGS

FLASHINGS

Any shape and size which can be rolled and bent can be produced and powder coated to most RAL Colours
Please supply a drawing for pricing showing sizes and finish required.

PLASTICLAD CLADDING ACCESSORIES BY PLASTESTRIP

ALUMINIUM EXTERNAL CORNER PROFILES

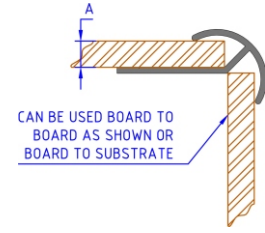
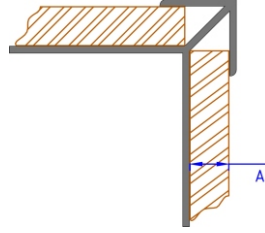
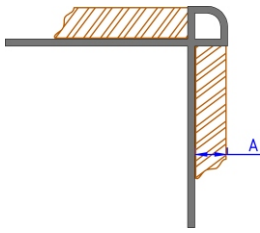

Ref	A (mm)	Suitable for	Ref	A (mm)	Suitable for	Ref	A (mm)	Suitable for
AL/16P AL/18P AL/110P	6.5 8.5 10.5	6mm Board 8mm Board 10mm Board	AL/EX6 AL/EX8 AL/EX10	6.5 8.5 10.5	6mm Board 8mm Board 10mm Board	AL/CV6 AL/CV8 AL/CV10	6.5 8.5 10.5	6mm Board 8mm Board 10mm Board
3055mm Lengths			3055mm Lengths			3055mm Lengths		

IN ANODISED, STD / NON STD & RAL DESIGN COLOURS

IN ANODISED, STD / NON STD & RAL DESIGN COLOURS

IN ANODISED, STD / NON STD & RAL DESIGN COLOURS

ALUMINIUM EXTERNAL CORNER PROFILES

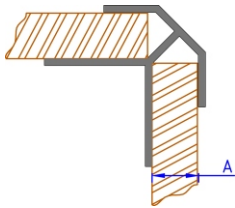

ALUMINIUM INTERNAL CORNER PROFILES

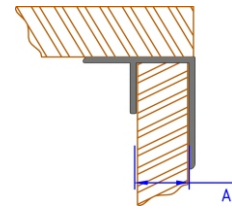

Ref	A (mm)	Suitable for	Ref	A (mm)	Suitable for
AL/FT/EX7 AL/FT/EX9 AL/FT/EX12 AL/FT/EX20	7.5 9.5 12.5 20.5	7mm Board 9mm Board 12mm Board 20mm Board	AL/EF6 AL/EF8 AL/EF10	6.5 8.5 10.5	6mm Board 8mm Board 10mm Board
3055mm LENGTHS			3055mm LENGTHS		

IN ANODISED, STD / NON STD & RAL DESIGN COLOURS

IN ANODISED, STD / NON STD & RAL DESIGN COLOURS

ALUMINIUM JOINT PROFILES

ALUMINIUM VERTICAL JOINING PROFILES

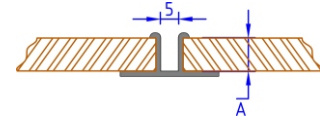
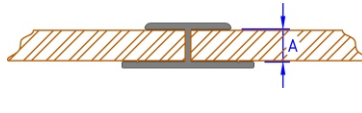

Ref	Suitable for	Ref	A (mm)	Suitable for	Ref	A (mm)	Suitable for
AL/ET4.5 AL/ET9	Any Board Any Board	AL/66P AL/68P AL/10P	6.5 8.5 10.5	6mm Board 8mm Board 10mm Board	AL/VSG/66 AL/VSG/88 AL/VSG/10	6.5 8.5 10.5	6mm Board 8mm Board 10mm Board
3000mm LENGTHS		3055mm LENGTHS		3055mm Lengths			

IN MILL FINISH, STD / NON STD & RAL DESIGN COLOURS

IN ANODISED, STD / NON STD & RAL DESIGN COLOURS

IN ANODISED, STD / NON STD & RAL DESIGN COLOURS

ALUMINIUM HORIZONTAL JOINING PROFILES

ALUMINIUM TOP DRIP PROFILES

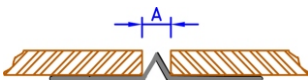

Can be used as a vertical profile

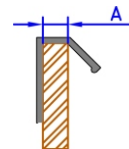
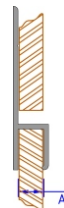

Ref	A (mm)	Suitable for	Ref	A (mm)	Suitable for	Ref	A (mm)	Suitable for
AL/TP6	6	Any Board	AL/CH6 AL/CH8 AL/CH10	6.5 8.5 10.5	6mm Board 8mm Board 10mm Board	AL/AD/6/11	12	5 - 12mm Board
3055mm LENGTHS			3055mm LENGTHS			3055mm LENGTHS		



IN ANODISED, STD / NON STD & RAL DESIGN COLOURS



IN ANODISED, STD / NON STD & RAL DESIGN COLOURS

IN ANODISED, STD / NON STD & RAL DESIGN COLOURS

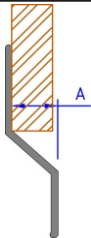
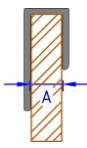
CAD DRAWINGS AVAILABLE ON REQUEST

PLASTICLAD CLADDING ACCESSORIES BY PLASTESTRIP

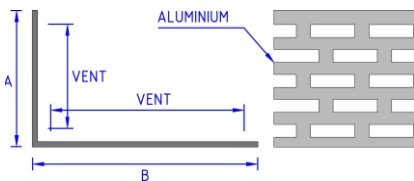
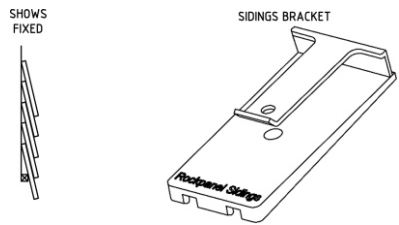
ALUMINIUM BOTTOM DRIP PROFILE			ALUMINIUM EDGE FINISHING			ALUMINIUM STARTER TRIM	
							
Ref	A (mm)	Suitable for	Ref	A (mm)	Suitable for	Ref	Suitable for
AL/BD/86 AL/BD/15	10.5 16.5	5 - 9mm Board 10 - 15mm Board	AL/76P AL/78P AL/710P	6.5 8.5 10.5	6mm Board 8mm Board 10mm Board	AL/ST/40	ROCKPANEL LINES
3055mm Lengths			3055mm Lengths			3055mm Lengths	
IN ANODISED, STD / NON STD & RAL DESIGN COLOURS			IN ANODISED, STD / NON STD & RAL DESIGN COLOURS			AVAILABLE IN ANODISED ALUMINIUM	

ALUMINIUM VENTILATION PROFILE				ROCKPANEL EASYFIX SIDINGS		TOOLS & ACCESSORIES	
							
Ref	A(mm)	B(mm)	Suitable for	Ref	Suitable for	Ref	Description
AL/VENT/30/40 AL/VENT/30/50 AL/VENT/60/70 AL/VENT/30/100 AL/VENT/30/120	30 30 60 30 30	40 50 70 100 120	All Boards All Boards All Boards All Boards All Boards	PL/RP/SLS/50	Rockpanel Lines	RIVET-GUN RIVET/GUN/BATTERY RIVET/GUN/CHARGER	12V Rivet gun Spare battery Spare charger
2500mm LENGTHS				200 PER BOX		KIT INCLUDES 1 BATTERY AND CHARGER	
AVAILABLE IN BLACK & MILL FINISH				AVAILABLE IN GREY PVC			

TOOLS & ACCESSORIES

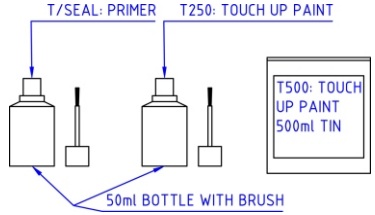
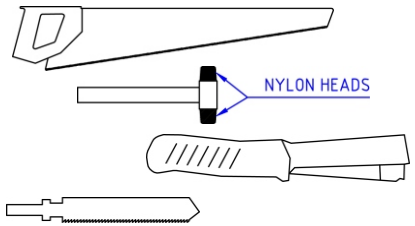
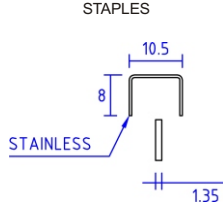
							
Ref	SIZE(ml)	Suitable for	Ref	Description	Ref	Suitable for	
T/SEAL T/250 T/500	50 50 500	Priming Rockpanel All Rockpanel All Rockpanel	135/160 125/123 PL/STAPLE/HAMMER 136/427	Saw for Rockpanel Nylon headed hammer Hammer stapler for PL/STAPLE Jigsaw bit suitable for Rockpanel	PL/STAPLE	Plain staples for fixing PLASTICLAD Gaskets and PLASTIBREATHE	
T/SEAL MUST DRY FOR 12 HRS BEFORE PAINTING			5000 PER BOX			AVAILABLE IN STAINLESS STEEL	
AVAILABLE IN ROCKPANEL STANDARD COLOURS							

PLASTIBREATHE

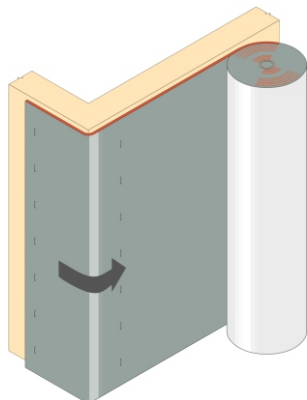

Ref	Description
PL/BREATHE/50X1.5	PlastiBreathe HDPE breathable underlay membrane
50 X 1.5m ROLL	
SPEC SHEET AVAILABLE ON REQUEST	

CAD DRAWINGS AVAILABLE ON REQUEST

PLASTICLAD CLADDING ACCESSORIES BY PLASTESTRIP

FIXINGS - STAINLESS STEEL UNLESS STATED OTHERWISE

PLASTICLAD NAIL			PLASTICLAD NAIL			SHIPLAP NAIL		
A4 GRADE			A4 GRADE			A4 GRADE		
Ref	A (mm)	Suitable for	Ref	A (mm)	Suitable for	Ref	A (mm)	Suitable for
864134	32	Fixing to timber	862131 862150	32 50	Fixing to timber Fixing to timber	893615	32	Fixing to timber
100 PER BOX			100 PER BOX			250 PER BOX		
AVAILABLE IN STD / NON STD & RAL DESIGN COLOURS			COLOURS: PLAIN			COLOURS: PLAIN		

FIXINGS - STAINLESS STEEL UNLESS STATED OTHERWISE

RIVET					SMALL HEAD TORX SCREW			LARGE HEAD TORX SCREW		
A4 GRADE					A4 GRADE			A2 GRADE		
Ref	A(mm)	GRIPS	B	Suitable for	Ref	A(mm)	Suitable for	Ref	A(mm)	Suitable for
RIVETS/18 RIVETS/23 RIVETS/119 RIVETS/124	18 23 18 23	8-13mm 14-19mm 8-13mm 14-19mm	ALUMINIUM ALUMINIUM STAINLESS STAINLESS	FOR FIXING CLADDING TO ALUMINIUM RAIL SYSTEMS	RP8 RP42	35 42	For fixing to timber For fixing to timber	RP25 RP12 RP60 WASH/EPDM/11/4.8	25 38 60 -	For fixing to timber For fixing to timber For fixing to timber EPDM washer available for Natura boards
100 PER BOX					100 PER BOX			100 PER BOX		
AVAILABLE IN STD / NON STD & RAL DESIGN COLOURS					AVAILABLE IN STD / NON STD & RAL DESIGN COLOURS			AVAILABLE IN STD / NON STD & RAL DESIGN COLOURS		

FIXINGS - STAINLESS STEEL UNLESS STATED OTHERWISE

SELF DRILLING SCREW		SELF DRILLING SCREW		SELF DRILLING SCREW	
A4 GRADE		A2 GRADE		A2 GRADE	
Ref	Suitable for	Ref	Suitable for	Ref	Suitable for
RP/FIX/20	Fixing 8mm Board into 1.2 - 3mm Aluminium	RP/ALUM/25	Fixing 6 - 8mm Board into 1.2 - 3mm aluminium	RP/STEEL/25	Fixing 6 - 10mm Board into 1.2 - 3mm steel and aluminium
100 PER BOX		100 PER BOX		100 PER BOX	
AVAILABLE IN STD / NON STD & RAL DESIGN COLOURS		AVAILABLE IN STD / NON STD & RAL DESIGN COLOURS		AVAILABLE IN STD / NON STD & RAL DESIGN COLOURS	

FIXINGS - STAINLESS STEEL UNLESS STATED OTHERWISE

SELF DRILLING SCREW		SELF DRILLING SCREW		HPL SECRET FIX SCREW		
A4 GRADE		A2 GRADE		A4 GRADE		
Ref	Suitable for	Ref	Suitable for	Ref	A (mm)	Suitable for
861232	Fixing 6 - 10mm Board into 3 - 5mm steel	871240	Fixing 6 - 12mm board into 6 - 12mm steel	PL/PTS/9.5 PL/PTS/11.5 PL/PTS/14.5 PL/PTS/WASHER/0.5 PL/PTS/WASHER/1.0	9.5 11.5 14.5 - -	HPL Secret Fix HPL Secret Fix HPL Secret Fix all above screws all above screws
100 PER BOX		100 PER BOX		100 PER BOX		
AVAILABLE IN STD / NON STD & RAL DESIGN COLOURS		AVAILABLE IN STD / NON STD & RAL DESIGN COLOURS		COLOURS: PLAIN		

PLASTICLAD CLADDING ACCESSORIES BY PLASTESTRIP

ROCKPANEL TACK ADHESIVE

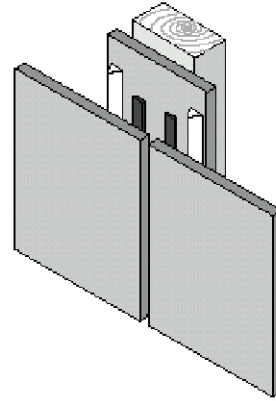

Ref	Description
PL/AD/FP/GLUE	Rockpanel tack glue - 290ml
PL/AD/FP/WP	Primer for wood and Rockpanel - 1000ml
PL/AD/FD/MP	Primer for metal track only - 500ml
PL/AD/FD/FT	Foam joint tape for system - 25m coils
PL/AD/AS/RS	Roller frame, 10 rollers & tray appl. set
PL/AD/FS/SR	Set of 10 spare rollers
PL/AD/FC/CLEAN	Liquid cleaner - 500ml
SKELETON/GUN	290 - 310ml applicator gun

Data sheet and installation guide available on request

SIKA PANEL ADHESIVE



Ref	Suitable for
SIKATACK/310ML	Adhesive tube - 310ml
SIKATACK/600ML	Adhesive sausage - 600ml
SIKATACK/PRIMER/1LT	Primer - 1000ml
SIKATACK/CLEANER/1LT	Cleaner - 1000ml
SIKATACK/CLEANER/250ML	Cleaner - 250ml
SIKATACK/TAPE/33M	Tape - 33m
SIKATACK/SAU/GUN	Sausage applicator gun
SIKATACK/ELECTRIC/GUN	Electric applicator gun kit
SKELETON/GUN	290 - 310ml applicator gun
PL/AD/AS/RS	Brush roller and tray appl. set
PL/AD/FS/SR	Set of 10 spare rollers

Data sheet and installation guide available on request

ALUMINIUM FACADE SUPPORT RAILS

ALUMINIUM SECRET FIX SYSTEM FOR HPL

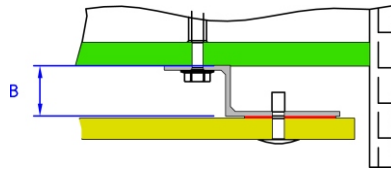
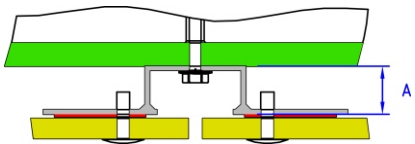

Ref	A(mm)	Suitable for
AL/TH/26/50	26	Any Board
AL/TH/40/55	40	Any Board

Ref	A (mm)	Suitable for
AL/Z/26/50/26	26	Any Board
AL/Z/40/55/26	40	Any Board

Ref	Suitable for
AL/RAIL/HANG/M	Carrier rail to suit Secret Fix System for HPL

5000mm LENGTHS

5000mm LENGTHS

AVAILABLE IN 5000mm OR 6000mm LENGTHS

Typical application detail available on request

Typical application detail available on request

Typical application detail available on request

ALUMINIUM SECRET FIX SYSTEM FOR HPL

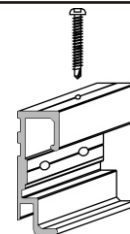
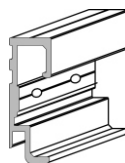
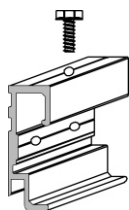

Ref	Description
AL/RAIL/BR/ADJ	Adjustable bracket complete with M6x20 bolt

Ref	Description
AL/RAIL/BR/FIX	Standard bracket

Ref	Description
AL/RAIL/BR/SCREW	Locking bracket complete with 848775 screw

Typical application detail available on request

Typical application detail available on request

Typical application detail available on request



CHECKLIST AVAILABLE ON OUR WEBSITE
ADJUSTABLE FACADE SUPPORT SYSTEM

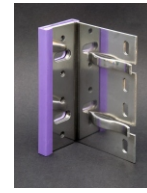

Ref	Description	Ref	Description
FIX/BR/65 FIX/BR/80 FIX/BR/100 FIX/BR/120 FIX/BR/140 FIX/BR/160 FIX/BR/180 FIX/BR/200 FIX/BR/220 FIX/BR/240	65mm single bracket for 80-105mm standoff 80mm single bracket for 88-120mm standoff 100mm single bracket for 108-140mm standoff 120mm single bracket for 128-160mm standoff 140mm single bracket for 148-180mm standoff 160mm single bracket for 168-200mm standoff 180mm single bracket for 188-220mm standoff 200mm single bracket for 208-240mm standoff 220mm single bracket for 228-260mm standoff 240mm single bracket for 248-280mm standoff	FIX/BRD/65 FIX/BRD/80 FIX/BRD/100 FIX/BRD/120 FIX/BRD/140 FIX/BRD/160 FIX/BRD/180 FIX/BRD/200 FIX/BRD/220 FIX/BRD/240	65mm double bracket for 80-105mm standoff 80mm double bracket for 88-120mm standoff 100mm double bracket for 108-140mm standoff 120mm double bracket for 128-160mm standoff 140mm double bracket for 148-180mm standoff 160mm double bracket for 168-200mm standoff 180mm double bracket for 188-220mm standoff 200mm double bracket for 208-240mm standoff 220mm double bracket for 228-260mm standoff 240mm double bracket for 248-280mm standoff

FASTFRAME ADJUSTABLE FACADE SUPPORT SYSTEM

STAINLESS FIXINGS FOR FASTFRAME SYSTEM

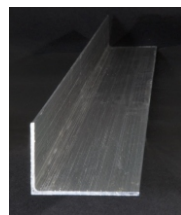
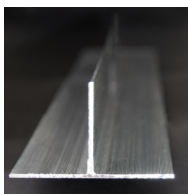

Ref	Description	Ref	Description	Ref	Description
FIX/TEE/HD/100/60	Heavy duty aluminium T rail	FIX/ANG/HD/60/40	Heavy duty aluminium Angle rail	JT4-4-4.8X19 JT4-6-5.5X19	4.8x19mm Rail to bracket screw For fixing AL/RAIL/HANG/M to Fast Frame rails
6m LENGTHS		6m LENGTHS		100 PER BOX	

STAINLESS FIXINGS FOR FASTFRAME SYSTEM



Ref	Description	Ref	Description	Ref	Description
SDF-KB-10X60 SDF-KB-10X80 SDF-KB-10X100	60mm Concrete & brick anchor 80mm Concrete & brick anchor 100mm Concrete & brick anchor	SDF-KB-10L X100 SDF-KB-10L X120 SDF-KB-10L X160	100mm Honeycomb brick anchor 120mm Honeycomb brick anchor 160mm Honeycomb brick anchor	SDF-KB-10U X80 SDF-KB-10U X100 SDF-KB-10U X120	80mm Low density concrete/blockwork anchor 100mm Low density concrete/blockwork anchor 120mm Low density concrete/blockwork anchor
100 PER BOX		100 PER BOX		100 PER BOX	

STAINLESS FIXINGS FOR FASTFRAME SYSTEM

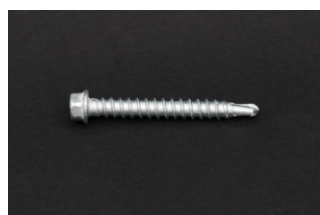

Ref	Description	Ref	Description	Ref	Description
SDF-KB-10S X80 SDF-KB-10S X100 SDF-KB-10S X120	80mm Aerated concrete block anchor 100mm Aerated concrete block anchor 120mm Aerated concrete block anchor	JT3-2-6.5X50	50mm Bracket to timber fixing	JT3-3-6.3X50	50mm Bracket to steel fixing
100 PER BOX		100 PER BOX		100 PER BOX	

Terms & Conditions of Sale

1. General

1.1 Every offer, tender, quotation, acceptance and contract for the sale or supply of goods including services associated with the goods by Plastestrip (Profiles) Ltd (hereinafter referred to as the "Company") is made subject to these conditions and all other terms and conditions proposed by the purchaser (hereinafter referred to as the "Buyer") are expressly excluded.

2. Acceptance of orders

2.1 Orders are subject to the Buyer's credit status being approved by the Company, using whatever means of checking that the Company deems suitable.

2.2 Order must contain sufficient information to enable the Company to manufacture the goods required. No liability can be accepted for goods incorrectly ordered by the buyer.

2.3 Telephone orders will not be accepted. All orders must be in writing. Facsimile orders will be deemed to be equivalent to orders received in writing and will be subject to these Terms and Conditions.

2.4 Products to customers specifications will require signed sample approval forms prior to bulk production.

3. Quotations

3.1 No oral quotation will be binding upon the Company and quotations are only given upon the Company's official forms. Quotations shall only be available for acceptance by the Buyer on the Company's terms and conditions for a maximum of 30 days from the date of the quotation (unless otherwise specified).

3.2 Where the Buyer purports to accept a quotation in respect of quantities or specification of goods different or in instalments smaller than those quoted, or a delivery over a different period or to a different location, the Company shall be entitled to treat such purported acceptance as a further enquiry in respect of which a separate quotation may be issued.

4. Literature/Samples

4.1 Any literature detail, sample, mock up, colour representation supplied by the Company to the Buyer shall be accepted as being supplied solely for the information and is in no way importing any express or implied conditions of warranty as to quality, description, colour, fitness for purpose or merchantable quality of goods subsequently delivered and the Buyer shall be deemed to have satisfied himself as to such matters prior to ordering any goods.

4.2 Literature, catalogues and advertising matter are issued to indicate the type and range of goods offered for sale. Particulars contained therein may be subject to amendment and are not binding upon the Company.

5. Prices

5.1 Quotations only indicate the price ruling at the date of quotation and all goods will be charged at the prices ruling at the date of despatch.

5.2 All prices quoted are exclusive of VAT, which will be charged at the prevailing rate at the date of invoice.

6. Payment

6.1 Unless the company notifies the Buyer otherwise in writing, payment will become due on or before the thirtieth day of the month following the date of invoice.

6.2 Payment shall not be deemed to have been made or received until cash has been handed to an officer of the Company, or any cheque or draft paid to the Company shall have been cleared and the Company's bank account credited with the amount in which the cheque or draft is drawn.

6.3 where the goods are for delivery abroad, payment shall be made by irrevocable letter of credit opened with a bank in the United Kingdom, approved by the Company with payment being made against presentation of the usual shipping documents, or by Telegraphic Transfer prior to the goods being despatched.

6.4 The Company reserves the rights to charge interest upon invoices which become overdue for payment at the rate of three per cent per annum above the Yorkshire Bank Plc base rate.

6.5 Failure by the Buyer to make payment on or by any due date shall constitute a breach of contract and the Company may suspend all further deliveries of goods under any contract until payment for all goods specified on a scheduled order.

7. Scheduled Orders

7.1 A scheduled purchase order shall constitute authority to manufacture the total goods as specified on the order. The Buyer shall be obliged to take delivery and make payment for all goods specified on a scheduled order.

7.2 The maximum interval between scheduled delivery dates and the maximum notice for change to scheduled delivery dates shall be four weeks.

7.3 The Buyer shall at all times be liable for the current scheduled total stocks, work in progress, specially purchased materials and special manufacturing tools required to fulfil the scheduled order.

8. Deferred Deliveries

8.1 Should the Buyer defer any previously agreed delivery date (whether for full or part deliveries), the Company will invoice the Buyer as if the goods had been delivered and payment shall become due according to the normal terms of payment. The Company may also charge storage costs for the period of deferment.

9. Manufacturing Tolerances and Specifications

9.1 If manufacturing tolerances or surface finishes are not clearly defined in any specification or drawing supplied by the Buyer, the Company reserves the right to manufacture to the Company's commercially accepted tolerance or finish and from the Company's commercially accepted material for the product concerned.

9.2 Where detailed specifications are to be supplied by the Buyer, such specifications must be supplied at the time of placement of the order unless otherwise agreed in writing by an officer of the Company.

9.3 Where additional or changed information is supplied to the Company by the Buyer after placement of any purchase order, the Company reserves the right to increase prices to cover any costs arising from and any losses incurred by the Company as a result of such alteration, and to extend the delivery period.

9.4 The Company reserves the right to alter the specification of any goods without prior reference to the Buyer, provided that the goods comply in all known respects with the Buyer's requirements.

9.5 The Company will not accept liability for minor variations in sizes or colour matching tolerances within commercially accepted limits.

9.6 Where goods have been supplied to the Buyer's specifications, the Company will not accept liability for any failure or defect of such goods and the buyer shall indemnify the Company against all actions, claims, costs and proceedings, including claims that the specification or goods infringe the intellectual property rights of another. The Company gives no warranty as to the fitness for any particular purposes of goods so supplied to the buyer's own specification and cannot accept liability for clerical or drawing errors on the specification supplied by the Buyer.

10 Delivery (External carriers terms apply when goods are sent this way).

10.1 Although the Company will make every effort to deliver goods on the agreed date, time is not of the essence of the contract. Any quoted delivery dates or supply periods are business estimates only and the Company shall not be liable for any loss or damage whatsoever incurred by delayed delivery of goods.

10.2 All quoted delivery periods are based upon the Buyer submitting and/or approving any relevant drawings at the time of placing the order.

10.3 In such cases where the Company concludes the contract of carriage or shipment and/or arranges for the insurance of the goods for transit, the Company shall be deemed to be acting solely as an agent for the Buyer and sub-sections (2) and (3) of section 32 of the Sale of Goods Act 1979 shall be inapplicable.

10.4 Carriage is charged on all deliveries as all prices quoted are ex works unless otherwise stated on quotations in writing by the company.

10.5 Unless otherwise agreed in writing, the Company reserves the right to determine the most economical route and type of vehicle to be used to effect all deliveries. The Company reserves the right to make charges for all abortive journeys undertaken against the Buyer's instructions. Buyer's instructions which restrict the type of vehicle to be used must be agreed in writing and may be subject to an additional carriage charge.

11. Export Orders

11.1 All export sales are subject to the Company obtaining the necessary export licences and any other permits, and in the event that any such licence or permit cannot be obtained, the contract shall be void and the Company shall be under no liability whatsoever to the buyer.

11.2 The Buyer shall obtain the necessary import licences and permits in the country of destination but failure to obtain any such licence or permit shall not avoid the contract or relieve the Buyer of its obligations to accept and pay for the goods.

12. Title to Goods

12.1 The legal and equitable title to all goods supplied under any contract will not pass to the Buyer until the price of the goods has been paid in full and until such payment the Buyer will hold the contract goods in a fiduciary capacity as Bailee for the Company.

12.2 Where the contract goods are resold by the Buyer and at the time of such resale the title in such contract goods has not yet passed to the Buyer, then proceedings of such resale shall be held by the Buyer in fiduciary capacity on trust for the Company and the Buyer will account to the Company for the same to the extent necessary to pay the price for the contract goods.

12.3 The Buyer shall so long as the Company is entitled to the property in the contract goods store the same so that they are identifiable as the property of the seller.

12.4 Without prejudice to any of the Company's other rights (whether to damages or under the contract or otherwise) the Company may at any time after the price for the contract goods has become due and remains unpaid, rescind the contract and/or recover any contract goods which are still the property of the Company and may enter onto the Buyer's premises or instruct agents for that purpose.

12.5 Whether or not the price for the contract goods has become due from the Buyer under the contract, such price will be deemed to be due from the Buyer immediately on the Buyer becoming bankrupt, calling a meeting (whether formal or informal) of any of its creditors, or (where the Buyer is a body corporate) having a receiver or manager appointed of its undertaking or any part thereof, or on a resolution being passed on a petition being presented to any court for the winding-up of the Buyer, or the commencement of any proceedings whatsoever relating to the insolvency or possible insolvency of the Buyer.

12.6 Notwithstanding the foregoing provisions the risk in the contract goods shall pass on delivery to the Buyer.

13. Damage / Loss / Non-delivery

13.1 The Company cannot accept responsibility for damage to goods, mis-delivery or non-delivery where the carrier has been given a clear receipt by the Buyer.

13.2 Any loss of or damage to goods must be notified to the Company immediately upon receipt of the goods by telephone and confirmed in writing within 24 hours thereafter. The Buyer shall at the same time notify the carrier in writing of any such loss and shall enter a note of the same upon the carrier's paperwork. If the Buyer fails to give any notice as provided above, and the Company is precluded from making recovery from the carrier in respect of loss or damage complained of then the Buyer shall be liable to pay for the goods as though no such loss or damage had occurred.

13.3 No goods will be accepted as returns unless agreed in writing by the Company first. Specials cannot be returned. The Company reserves the right to charge a restocking fee of 30%. Any carriage incurred by the Company will be deducted from any credits value.

14. Quality of Product

14.1 Goods proved to be defective within 1 week of the date of despatch from the Company's works will be replaced at the place of original delivery and the Company's liability shall in no circumstances exceed the invoice value of the goods accepted as being defective. No allowance will be made for the Buyer's labour, expenses or consequential loss.

14.2 This guarantee does not apply to and no responsibility will be accepted for damage occurring in transit, or for goods which have suffered or been subjected to undue wear and tear, accident, mis-use, improper application, neglect or overloading.

14.3 The Company shall be under no liability in respect of the quality, condition or description of the goods or for loss or damage including consequential loss or damage howsoever caused to the Buyer or to any other person.

15 Force Majeure

15.1 The Company shall not be liable for any failure to observe or for any breach of any of the terms hereof by reason of force majeure and in such events deliveries may be wholly or partially suspended by the Company during the operation of force majeure and the time of such suspension shall be added to the delivery time specified in the original contract.

16. Breach of Contract

16.1 If the Buyer shall make default or commit a breach of contract or of any other of its obligations to the Company, or if any distress or execution shall be levied upon the Buyer's property or assets, or if the Buyer shall make or offer any arrangement or composition with its creditors, or commit any act of bankruptcy or if any resolution or petition to wind up the Buyer's business shall be passed or presented the Company may without notice: (a) suspend or determine the contract or any unfulfilled part thereof without prejudice to its existing rights thereunder. (b) stop any goods in transit. (c) recover from the Buyer's premises any goods which are the property of the Company and (d) be entitled to claim against the Buyer for any loss or damage sustained by such suspension or determination.

16.2 A tooling contract is available as a separate document copy which also covers copyrights and patents.

17. Intellectual Property

17.1 All patterns, drawings, sketches and designs produced by the Company shall remain the property of the company. The Buyer may not utilise, reproduce or communicate knowledge of such items and the Buyer shall return the same to the Company at the Company's request.

17.2 Indemnity

Where any products supplied by the company pursuant to these conditions are produced to the buyer's designs, plans or specifications the buyer shall indemnify us and keep us indemnified against all actions, claims, costs, damages or losses incurred by us for the infringement or alleged infringement of any patent, registered design, trademark, known design, copyright or similar protection in respect of the products so produced and/or as a consequence of such designs, plans or specifications proving to be defective in any way or leading to the manufacture of a defective product.

18 Sub-contract Manufacture

18.1 The Company reserves the right to sub-contract their fulfilment of any order or contract or any part thereof.

19. Statutory Rights

18.1 Nothing contained herein is intended to affect nor will it affect a consumer's statutory rights.

20. Law

20.1 These conditions and any contract to supply goods shall be subject to and construed in accordance with English Law and the parties hereby agree to accept the exclusive jurisdiction of the English Courts in all matters connected therewith or relating thereto.

20.2 Minimum invoice of £50 (please send cheque with order if less than £50) carriage and packing to be charged at cost.

20.3 Fixing and Application

Fixing and application of our products is the responsibility of the Buyer and is not the responsibility of ourselves as is the suitability for application.

Updated to meet legal requirements 01/10/1998

COPYRIGHTS RESERVED On all products and literature.

Plastestrip (Profiles) Ltd reserves the right to alter or amend items and prices without notification as their policy is one of constant product improvement.

