

VERTICAL

HORIZONTAL

Without Float

- PTS 0.75 - 40 M
- PTS 1.1 - 40 M
- PTS 0.75 - 40 T
- PTS 1.1 - 40 T

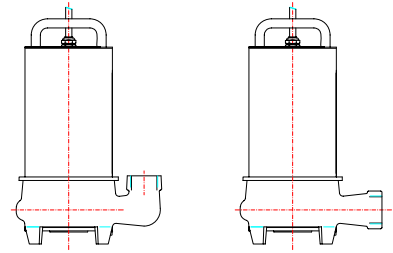

With Float

- PTS 0.75 - 40 MG
- PTS 1.1 - 40 MG
- PTS 0.75 - 40 TG
- PTS 1.1 - 40 TG

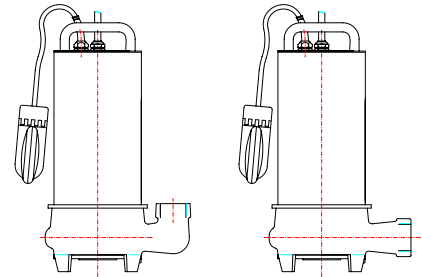

		OPERATING DATA											
ELECTRIC PUMP TYPE	MOTOR RATING	DELIVERY	CAPACITY l / min										
			0	60	120	180	210	240	270	300	330	360	420
			CAPACITY m ³ / h										
			0	3.6	7.2	10.8	12.6	14.4	16.2	18	19.8	21.6	25.2
			CAPACITY l / sec										
0	1	2	3	3.5	4	4.5	5	5.5	6	7			
		DN	HEAD m										
PTS 0.75 - 40 M / T	0.75		13.5	13.3	12.8	11.8	11	10.1	9.2	8	6.6	4.9	
PTS 1.1 - 40 M / T	1.1	40	17.5	17.4	16.9	15.9	15.2	14.3	13.3	12.2	10.9	9.4	5.9

50 Hz - MOTOR FEATURES - VOLTAGE RATING 400 V ± 10%

ELECTRIC PUMP TYPE	MOTOR RATING	WINDINGS	ABSORPTION	R.P.M.	FEEDING CABLE			START	
					n° cables	n° of wires x size - mm ²	cable length (m)	direct	Δ
SINGLE PHASE									
PTS 0.75 - 40 M	0.75	230	5.0	2750	1	3 x 1.5	10		
PTS 0.75 - 40 MG	0.75								
PTS 1.1 - 40 M	1.1								
PTS 1.1 - 40 MG	1.1								
THREE PHASE									
PTS 0.75 - 40 T	0.75	400	1.9	2800	1	4 x 1.5	10	Δ	
PTS 0.75 - 40 TG	0.75							Δ	
PTS 1.1 - 40 T	1.1							Δ	
PTS 1.1 - 40 TG	1.1							Δ	



STANDARD FEATURES

- Asynchronous threephase and singlephase electric motors with squirrel cage rotor.
- "IP 68" Protection.
- "F" class insulation.
- Max submergence depth: 20 m.
- Max solid content in the liquid: 12%.
- Submersible HO7-RN-F neoprene cable.
- Fluid pH 5 - 12.
- Max temperature of pumped fluid: 40°C.
- Continuous service.

Without Float

- PTS 0.75 - 40 M
- PTS 1.1 - 40 M
- PTS 0.75 - 40 T
- PTS 1.1 - 40 T

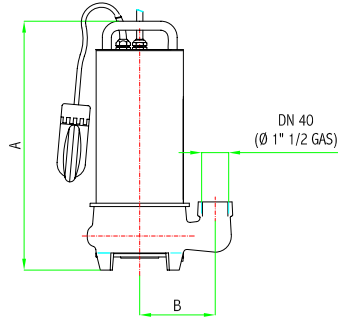

VERTICAL

With Float

- PTS 0.75 - 40 MG
- PTS 1.1 - 40 MG
- PTS 0.75 - 40 TG
- PTS 1.1 - 40 TG

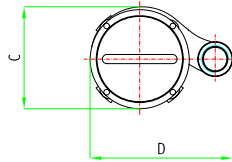

HORIZONTAL

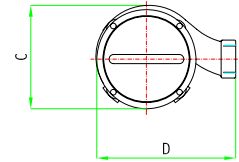
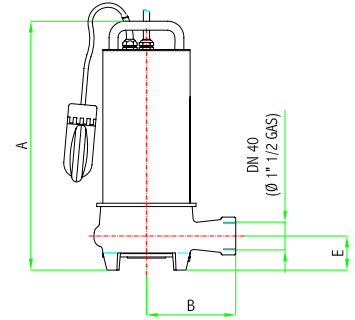

- OVERALL DIMENSIONS mm. -

ELECTRIC PUMP TYPE	DN	VERTICAL				HORIZONTAL					Weight kg
		A	B	C	D	A	B	C	D	E	
PTS 0.75 - 40 M	40	440	133	177	257	440	153	177	240	60	20.5
PTS 0.75 - 40 MG											21
PTS 1.1 - 40 M											20.5
PTS 1.1 - 40 MG											21
PTS 0.75 - 40 T											20
PTS 0.75 - 40 TG											20.5
PTS 1.1 - 40 T											20
PTS 1.1 - 40 TG											20.5

ACCESSORI

ACCESSORIES

ACCESSOIRES

Motor bracket

Spacer

Hoist winch and rail pipe

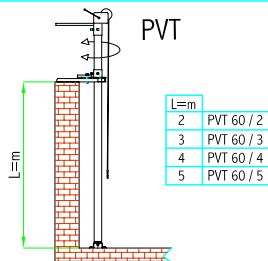
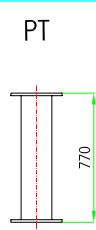
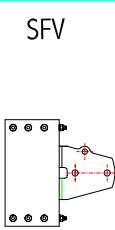

ELECTRIC PUMP TYPE

- PTS 0.75 - 40 M
- PTS 0.75 - 40 MG
- PTS 1.1 - 40 M
- PTS 1.1 - 40 MG
- PTS 0.75 - 40 T
- PTS 0.75 - 40 TG
- PTS 1.1 - 40 T
- PTS 1.1 - 40 TG

SFV 60

PT 60

PVT 60 /..

POSSIBLE INSTALLATIONS

