

DOOR DAMPER LDD-V



INSTRUCTION

VIDEO



LDD-V-R (right-handed) shown. LDD-V-L (left-handed) is symmetrical.



Door damper is completely hidden when the door is closed. (Picture: right-handed)

[Body]

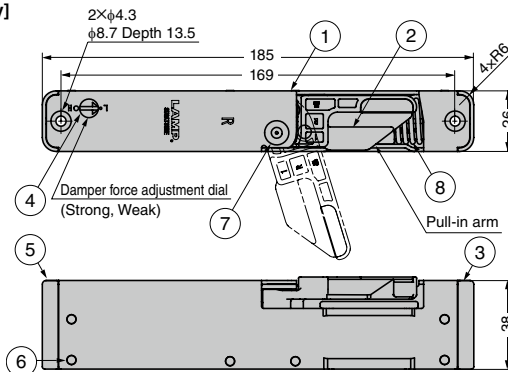

[Counter Plate]

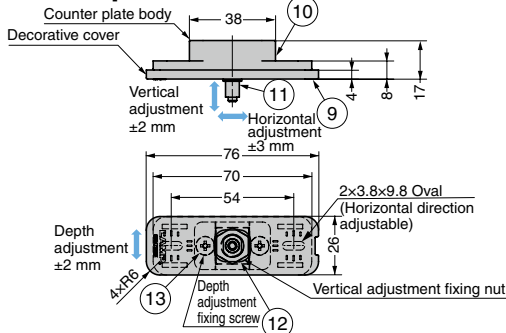

※Refer to **7** for the cut out dimensions, installation and safety cautions.

RHS	CAD	Item Code	Item Name	Type	Door Width	Door Thickness	Door Weight kg	Weight (g)	Box (pcs)	Carton (pcs)
G	3D	270-017-563	LDD-V-R	Right-handed	Max. 900	Min. 33	15-40	427	1	24
G	3D	270-017-564	LDD-V-L	Left-handed				427	1	24

Refer to **1** : P.90, **2** : P.95, **3** **4** : P.167, **5** : P.166, **6** : P.713, **7** : P.711

- Damper body is completely hidden when the door is closed.
- Damper and door pull-in functions work just before the door fully closes, preventing the door from slamming shut.
- Door can be opened more easily as compared with door closer.
- Damper force can be switched between two levels.
- Counter plate is 3-way adjustable.
- Can be used with the following hinges.
 - 3-way adjustable concealed hinge HES3D **1**
 - ※ Can not be used with HES3D-90 **2**.
 - Spring hinge ST150-6314-05 **3**
 - Aluminium spring lift-off hinge PM120 **4**
 - Spring hinge SA **5**
- Surface mount door damper LDD-S **6** also available.

[Parts Included]

- Binding head tapping screw 4 x 45
- Binding head tapping screw 3.5 x 20

[Door Movement]

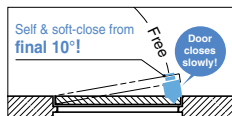

LDD-V-R (right-handed) shown.
LDD-V-L (left-handed) is symmetrical.

[Door Hinge Side]

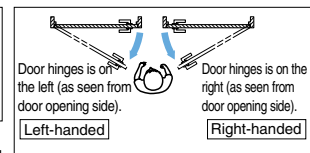

Video Link



No.	Part Name	Material	Finish / Colour
①	Body Case	Steel (SPCC)	Clear Zinc Chromate
②	Arm	POM	Grey
③	Spring Base		
④	Damper Force Adjustment Shaft		
⑤	Damper Base	Steel (SWCH)	Clear Zinc Chromate
⑥	Countersunk Hollow Pin		
⑦	Shoulder Shaft	Steel (SUM)	Nickel
⑧	Spring	Steel SWP	Clear Zinc Chromate
⑨	Counter Plate Cover	POM	Grey
⑩	Counter Plate Case		
⑪	Counter Plate Shaft	Steel (SUM)	Nickel
⑫	Vertical Adjustment Screw	Steel (SWRCH)	Clear Zinc Chromate
⑬	Depth Adjustment Screw	Steel (SWCH)	

[Cut Out Dimensions] Door Damper Body

Figure below is for LDD-V-R (right-handed). LDD-V-L (left-handed) is symmetrical.

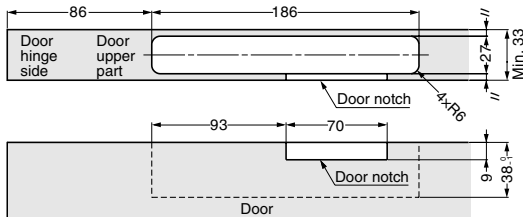
**[Installation]**

LDD-V-R (right-handed) shown. LDD-V-L (left-handed) is symmetrical.

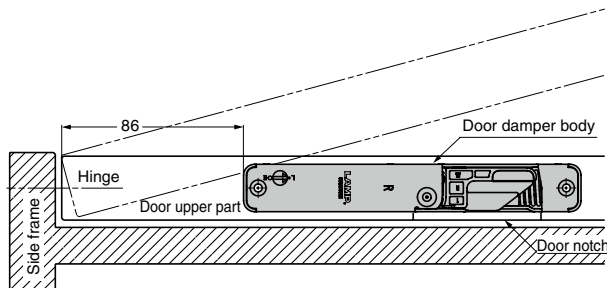

The installation position of counter plate from door hinge side varies depending on the hinges used.

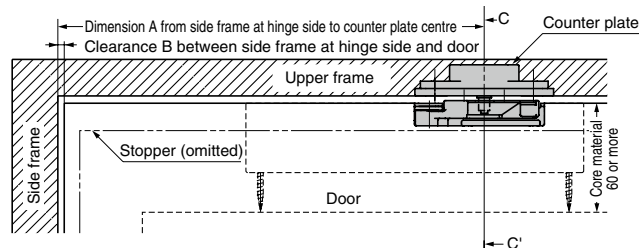

Embed the door damper body into the upper edge of the door and the counter plate into the upper frame.

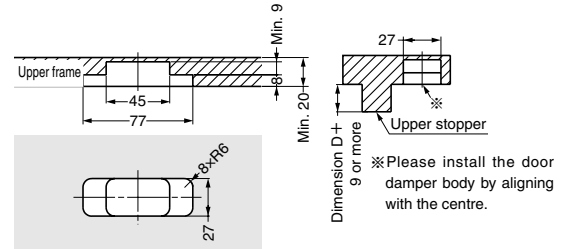
[Cut Out Dimensions] Counter Plate

The installation position of counter plate from door hinge side varies depending on the hinges used.

[Dimension A from Side Frame at Hinge Side to Counter Plate Centre]

Door Hinge	Clearance B Between Side Frame at Hinge Side and Door				
	1	2	3	4	5
HES3D-120	220	221	222	223	224
HES3D-160	221	222	223	224	225
HES3D-E190	221	222	223	224	225
HES3D-V135LGR	218	219	220	221	222
Butt Hinges	224	225	226	227	228

※If the clearance between the side frame at hinge side and the door is beyond the range of the above table, calculate as per the table below.

Door Hinge	Dimension A from side frame at hinge side to counter plate centre
HES3D-120	219+Clearance B Between Side Frame at Hinge Side and Door
HES3D-160	220+Clearance B Between Side Frame at Hinge Side and Door
HES3D-E190	220+Clearance B Between Side Frame at Hinge Side and Door
HES3D-V135LGR	217+Clearance B Between Side Frame at Hinge Side and Door
Butt Hinges	223+Clearance B Between Side Frame at Hinge Side and Door

※ Refer to [1](#) for 3-way adjustable concealed hinge HES3D.

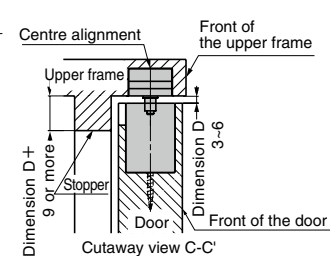
**⚠ Safety Cautions**

- ◆ **Do not drop or give strong impact to this product.**
- This product can not resist strong wind. Do not use under strong wind, or the damper effect will decrease.
- If you close the door with excessive force, the damper effect may decrease.
- The door may not close enough depending on the case lock used.
- This product is designed for interior use. Do not use it outdoors.
- Do not use it at places subject to moisture and water.
- At the entrance of highly airtight room, the door closing speed and damper force may change, and the door may not close enough.
- The closing speed varies depending on the use environment (temperature, wind and hinges used on the door, etc.). Operating temperature: 0°C ~ 40°C.
- Do not apply a load in the vertical direction or excessive force to pull-in arm. Otherwise, it may be damaged.
- Please install and adjust this product after adjusting the door hinges.
- Please use the door hinges within the adaptive door weight range of this product.
- Please install this product horizontally. Otherwise, it may not operate properly.
- After vertical adjustment of counter plate, tighten the fixing nut firmly.
- This product is supplied with installation instruction. Be sure to read before installation or use.
- Regularly check for looseness or dropout of screws during use.

Refer to [1](#) : P.90

ADJUSTMENT JIG FOR COUNTER PLATE OF LDD-V LDD-V-JIG



- For Lapcon door damper LDD-V  only.
- Used for adjusting the counter plate position of LDD-V.

[How to Use]**● 1. Install the adjustment jig**

- ① Fit the adjustment jig firmly into the body.
※ Right-handed and left-handed available.
※ Be sure to adjust the counter plate position after adjusting the installation position of the hinges.

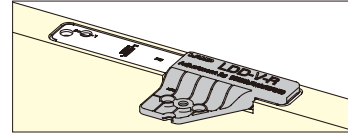
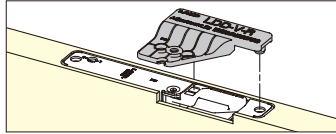
**● 2. Horizontally adjust the counter plate**

- ① Loosen the horizontal adjustment screws.
- ② While holding the adjustment jig by hand, slowly close the door and align the counter plate shaft with the groove.
- ③ Tighten the horizontal adjustment screws.

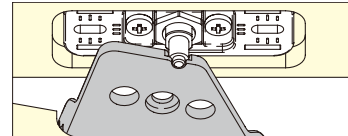
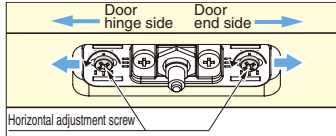
**● 3. Vertically adjust the counter plate**

- ① Loosen the fixing nut.
- ② While holding the adjustment jig by hand, slowly close the door and align the top of the counter plate shaft with the bottom of jig.
- ③ Tighten the fixing nut or the counter plate shaft firmly.

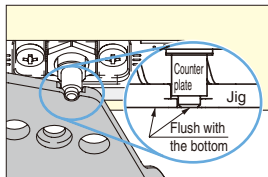

Finally tighten the fixing nut or counter plate shaft in either of the following ways



Finally tighten the fixing nut with a socket wrench (14mm) or a spanner (14mm).

Tighten the counter plate shaft with a spanner (8mm).

● 4. Check

- ① When removing the jig and closing the door slowly to the end, "click" sounds once.
※ If the door does not close to the end or "click" sounds twice, perform depth adjustment.
- ② When opening the door, "click" sounds once, and the arm is pulled out.
※ If the arm can not be pulled out, perform depth adjustment.
- ③ Check if the clearance between the arm and the counter plate is appropriate.

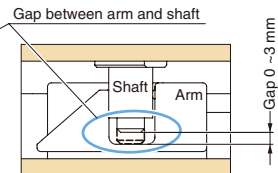
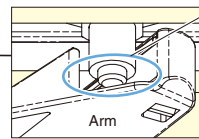
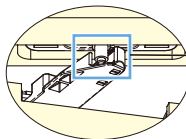

※ Depth adjustment of the counter plate (adjustment jig LDD-V-JIG can not be used for depth adjustment).

- ① Loosen the depth adjustment screws.
- ② Align the centre of the counter plate shaft with that of the door thickness.
- ③ Tighten the depth adjustment screws.

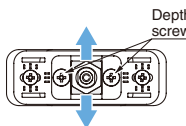

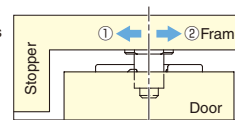

Depth adjustment screw

- ① When the door does not close to the end or "click" sounds twice (door stopper side)



- ② When the arm can not be pulled out

RcHS	CAD	Item Code	Item Name	Type	Material	Colour	Weight (g)	Box (pcs)	Carton (pcs)
	-	270-025-276	LDD-V-R-JIG	Right-handed	ABS	Orange	11	500	-
	-	270-025-275	LDD-V-L-JIG	Left-handed			11	500	-

Refer to  : P.710

TEMPLATE FOR LDD-V LDD-V-TMP



- Easy to make mortise on wood door and frame for LDD-V .
- Possible to use repeatedly.
- Two templates included: for door & frame.
- Recommended working tool is a straight bit with guide bearings of which guide diameter and bit diameter are the same.

RcHS	CAD	Item Code	Item Name	Material	Colour	Weight (g)	Box (pcs)	Carton (pcs)
	-	270-024-568	LDD-V-TMP	Methacrylic Resin (PMMA)	Clear	194	1	50

Refer to  : P.710

DOOR DAMPER LDD-S



When opening, the arm comes off from the counter plate and the door can rotate freely!

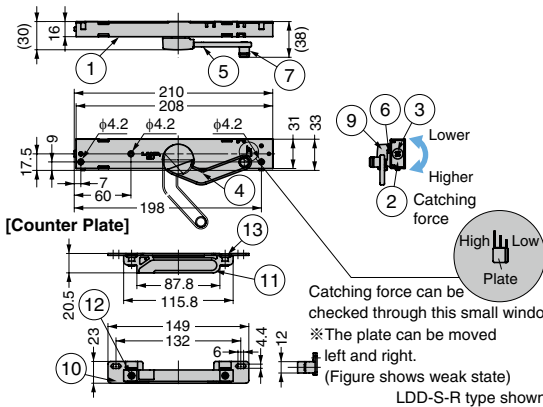

No.	Part Name	Material	Finish / Colour
①	Case	Steel (SGCC)	Chromate
②	Block	POM	Natural
③	Catching Force Adjustment Screw	Steel	Chromate
④	Arm	Stainless Steel (SUS304)	Plain
⑤	Arm Spacer	POM	See Below
⑥	Arm Axis	Zinc Alloy (ZDC)	Chromate
⑦	Roller	POM	Grey
⑧	Body Cover	ABS	See Below
⑨	Arm Cover		
⑩	Counter Plate	Steel (SPCC)	Chromate
⑪	Guide	Zinc Alloy (ZDC)	
⑫	Screw	Steel (SWCH)	
⑬	Nut	Steel (SPCC)	
⑭	Counter Plate Cover	ABS	See Below

RoHS	CAD	Item Code	Item Name	Colour	Type	Door Width	Door Weight kg	Weight (g)	Box (pcs)	Carton (pcs)
CE	3D	270-018-984	LDD-S-RWT	White	Right-handed	Max. 900	15-40	550	1	20
CE	3D	270-018-985	LDD-S-LWT		Left-handed			550	1	20
CE	3D	270-018-986	LDD-S-RLGR	Light Grey	Right-handed			550	1	20
CE	3D	270-018-987	LDD-S-LLGR		Left-handed			550	1	20
CE	3D	270-018-988	LDD-S-RLBR	Light Brown	Right-handed			550	1	20
CE	3D	270-018-989	LDD-S-LLBR		Left-handed			550	1	20
CE	3D	270-018-990	LDD-S-RDBR	Dark Brown	Right-handed			550	1	20
CE	3D	270-018-991	LDD-S-LDBR		Left-handed			550	1	20

Refer to ① : P.90, ② : P.95, ③ : P.167, ④ : P.166, ⑤ : P.166, ⑥ : P.710, ⑦ : P.714

- Surface mount type.
- Easy to determine installation position.
- Counter plate position and pull-in force (catching force) adjustable after installation.
- Unobtrusive design: damper unit is only 20mm high, easily fits most door frames.
- Self & soft-close from final 15°. Door starts to close slowly from a earlier position compared with conventional products, reducing the load applied on the hinges.
- Door can be opened more easily as compared with door closer.
- Suitable for maximum door weight 40kg.
- Self & soft-close function can be turned off when the arm is pulled in with door opened. (When the arm is pulled out, self & soft-close function can be turned on again.)
- Can be used with the following hinges.
 - 3-way adjustable concealed hinge HES3D ①
 - ※ Can not be used with HES3D-90 ② .
 - Spring hinge ST150-6314-05 ③
 - Aluminium spring lift-off hinge PM120 ④
 - Spring hinge SA ⑤
- Concealed type door damper LDD-V ⑥ also available.

[Specifications]

- Passed 100,000 open/close private cycle test.

[Parts Included]

- Countersunk head tapping screw 3.5 × 30
- Binding head tapping screw 4 × 16

[Door Movement]

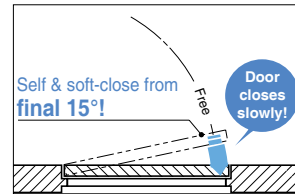

Right-handed type shown. Left-handed type is symmetrical.

[Door Hinge Side]

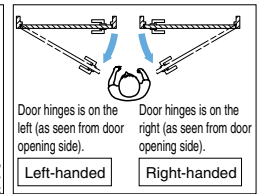

[Easy to Install and Adjust]

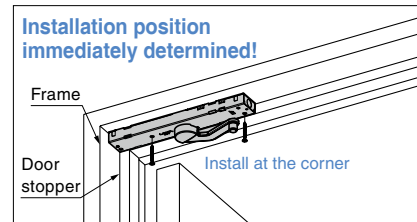

[Available Colours]



[Installation]

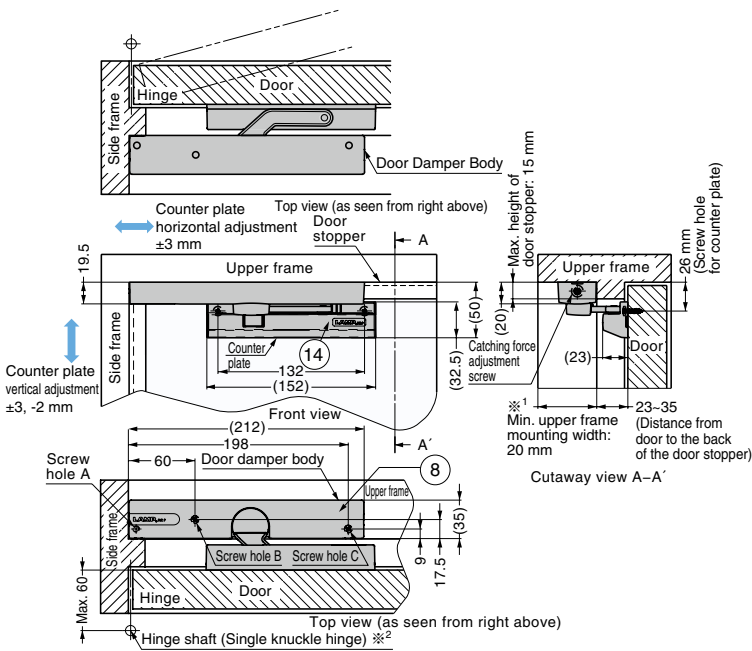

※¹ Top view above is for the upper frame mounting width above 25mm. When the distance from door to the back of the door stopper is 20mm~25mm, please use the screw hole A and C.

※² Refer to 1 for 3-way adjustable concealed hinge HES3D. ※ Can not be used with HES3D-90 2.

Refer to 1 : P.90, 2 : P.95

⚠ Safety Cautions

◆ Do not drop or give strong impact to this product.

- This product can not resist strong wind. Do not use under strong wind, or the damper effect will decrease.
- If you close the door with excessive force, the damper effect may decrease.
- The door may not close enough depending on the case lock used.
- This product is designed for interior use. Do not use it outdoors.
- Do not use it at places subject to moisture and water.
- At the entrance of highly airtight room, the door closing speed and damper force may change, and the door may not close enough.
- The closing speed varies depending on the use environment (temperature, wind and hinges used on the door, etc.). Operating temperature: 0°C ~ 40°C.
- Do not apply a load in the vertical direction or excessive force to pull-in arm. Otherwise, it may be damaged.
- Please install and adjust this product after adjusting the door hinges.
- Please use the door hinges within the adaptive door weight range of this product.
- This product is supplied with installation instruction.
- Be sure to read before installation or use.
- Regularly check for looseness or dropout of screws during use.

SPACER FOR LDD-S LDD-S-P



[Installation] In case of 5mm thickness gap

- Place the counter plate spacer on the gap part of the door and pinch it with the counter plate.

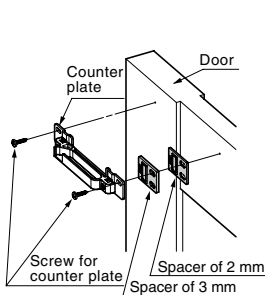

Installed counter plate

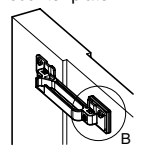

Detail B (as seen from above)

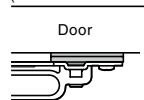

[Installation]

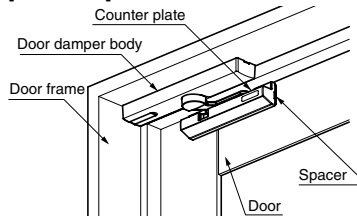

[Remarks Before Installation]

- Check the gap of the door surface and choose the suitable spacer (combination of spacers).



- For Lapcon door damper LDD-S 1
- Used when installing LDD-S to a door with gap.
- Two types available: 2mm thickness and 3mm thickness.
- Two spacers can be used in combination for gaps of 4, 5, 6mm.
- Counter plate of LDD-S adjustable vertically and horizontally with the spacer installed.

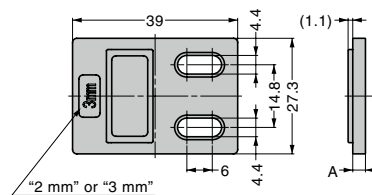

RoHS	CAD	Item Code	Item Name	Material	Colour	A	Weight (g)	Box (pcs)	Carton (pcs)
RoHS	3D	270-021-019	LDD-S-P2BL	ABS	Black	2	1.8	100	1000
RoHS	3D	270-021-020	LDD-S-P3BL			3	2.8	100	1000

Refer to 1 : P.713

DOOR DAMPER LDD-V100



INSTRUCTION



Soft close
"Smooth and soft closing"

Concealed type

Passed 100,000 open/close private cycle test

LDD-V100-NI-L shown.



Counter plate cover (Nickel/Dark brown)

- Unique door damper applicable to door weight up to 100 kg.
- Suitable for door weight 40~100 kg.
- Damper body is completely hidden when the door is closed.
- Damper and door pull-in functions work just before the door fully closes, preventing the door from slamming shut.
- Door can be opened more easily as compared with door closer.
- Damper force is adjustable.
- Counter plate is 3-way adjustable.
- Can be used with the following hinges.
 - HES3D-E190 **1**
 - HES3D-160 **2**

[Applications]

- Heavy duty interior door (shop, housing)

[Parts Included]

- Tapping screw 3.5 x 20
- Attachment Jig
- Cutout template

[Door Movement]

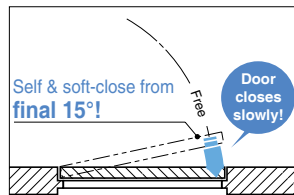

Right-handed type shown. Left-handed type is symmetrical.

[Door Hinge Side]

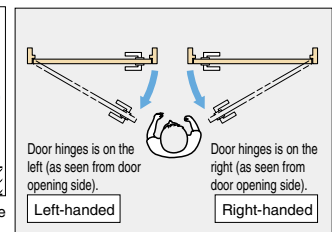

[Body]

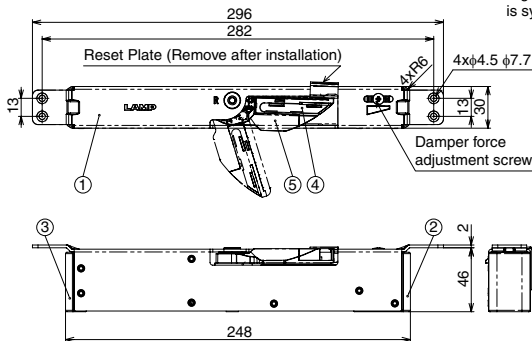

[Counter Plate]

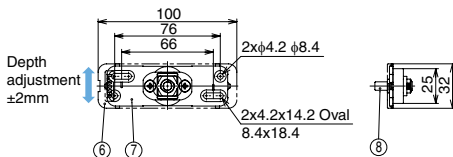
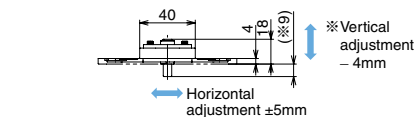

※Below drawing shows right-handed type. Left-handed type is symmetrica

● Installation

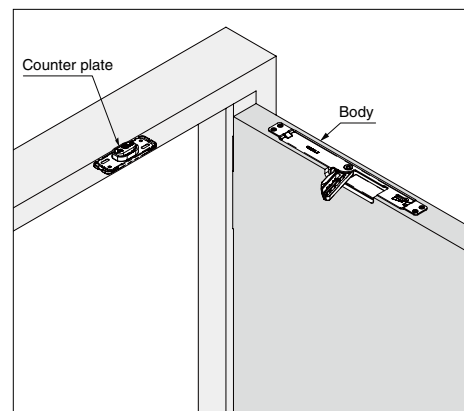

No.	Part Name	Material	Finish / Colour
①	Case	Steel (SPCC)	Nickel
②	Damper Base	POM	Grey
③	Spring Base	POM	Grey
④	Arm Cover	POM	Grey
⑤	Arm	Zinc Alloy (ZDC)	Nickel
⑥	Counter Plate Cover	ABS	Dark Brown/Nickel
⑦	Counter Plate Base	Zinc Alloy (ZDC)	-
⑧	Counter Plate Shaft	Steel (SUM)	Nickel

RHS	CAD	Item Code	Item Name	Type	Counter Plate Cover	Door Width	Door Thickness	Door Weight (kg)	Weight (g)	Box (pcs)	Carton (pcs)
		270-034-821	LDD-V100-DBR-R	Right-handed	Dark Brown	Max. 900	40~60	40~100	920	1	10
		270-034-822	LDD-V100-DBR-L	Left-handed					920	1	10
		270-034-823	LDD-V100-NI-R	Right-handed	Nickel				920	1	10
		270-034-824	LDD-V100-NI-L	Left-handed					920	1	10

Refer to **1** : P.92, **2** : P.93

MAGNETIC CATCHES

KNUCKLE CATCHES & TENSION CATCHES

TOUCH LATCHES

LEVER LATCHES

SLIDE / BARREL BOLTS

DRAW LATCHES

PUSH LOCK FASTENERS & KNOB FASTENERS

ALUMINIUM FRAME CORNER CONNECTORS

DOOR DAMPERS

[Cut Out Dimensions for Door]

LDD-V100-R (right-handed) shown. LDD-V100-L (left-handed) is symmetrical.

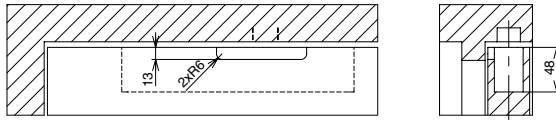
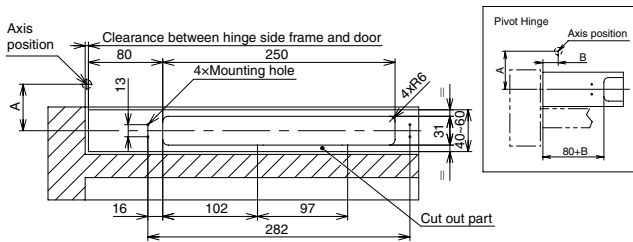
**Dimension from frame to bore position of counter plate (mm)**

Door Hinge	Clearance Between Hinge Side Frame and Door (mm)					
	1	2	3	4	5	
HES3D-160, E190	217	218	219	220	221	
Butt Hinge	A=20~35	220	221	222	223	224
Pivot Hinge	A=20~35	220+B	221+B	222+B	223+B	224+B
	A=35~50	223+B	224+B	225+B	226+B	227+B

※If clearance between hinge side frame and door is beyond the range in the table above, calculate as per the table below.

Door Hinge	Dimension from Frame to Bore Position of Counter Plate (mm)
HES3D-160, E190	216 + Clearance Between Hinge Side Frame and Door
Butt Hinge	A=20~35 219 + Clearance Between Hinge Side Frame and Door
	A=35~50 222 + Clearance Between Hinge Side Frame and Door
Pivot Hinge	A=20~35 219 + B + Clearance Between Hinge Side Frame and Door
	A=35~50 222 + B + Clearance Between Hinge Side Frame and Door

※ Refer to **1** for 3-way adjustable concealed hinge HES3D.

[Cut Out Dimensions for Frame]

LDD-V100-R (right-handed) shown. LDD-V100-L (left-handed) is symmetrical.

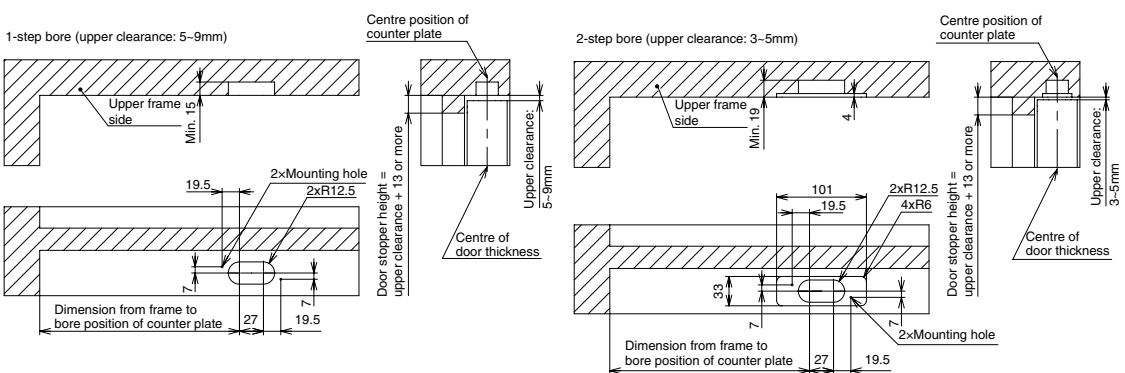
**⚠ Safety Cautions**

◆ **Do not drop or give strong impact to this product.**

- This product can not resist strong wind. Do not use it under strong wind, or the damper effect will decrease.
- If you close the door with excessive force, the damper effect may decrease.
- The door may not close enough depending on the case lock used.
- This product is designed for interior use. Do not use it outdoors.
- Do not use it at places subject to moisture and water.
- At the entrance of highly airtight room, the door closing speed and damper force may change, and the door may not close enough.
- The closing speed varies depending on the use environment (temperature, wind and hinges used on the door, etc.). Operating temperature: 0°C ~ 40°C
- Do not apply a load in the vertical direction or excessive force to pull-in arm. Otherwise, it may be damaged.
- Please install and adjust this product after adjusting the door hinges.
- Please use the door hinges within the adaptive door weight range of this product.
- Please install this product horizontally. Otherwise, it may not operate properly.
- After vertical adjustment of counter plate, tighten the fixing nut firmly.
- This product is supplied with installation instruction. Be sure to read before installation or use.
- Regularly check for looseness or dropout of screws during use.

Refer to **1** : P.90