



CORKBEE



**SOUND**  
ZERO

[sound-zero.com](http://sound-zero.com)

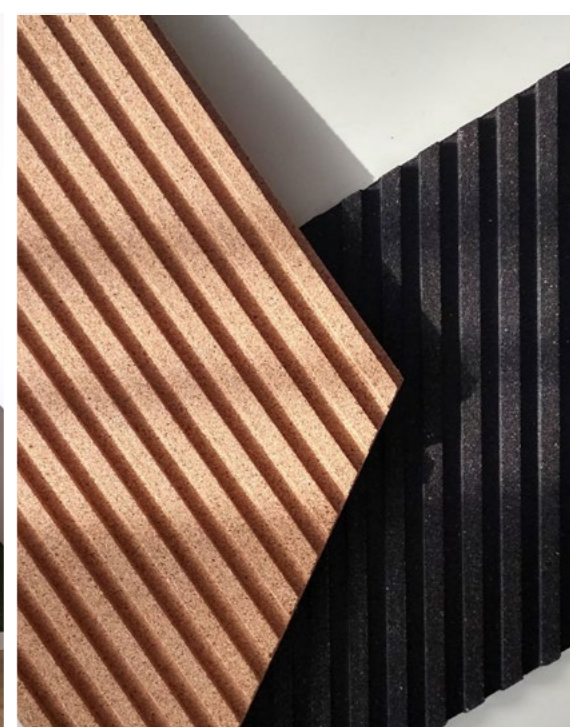
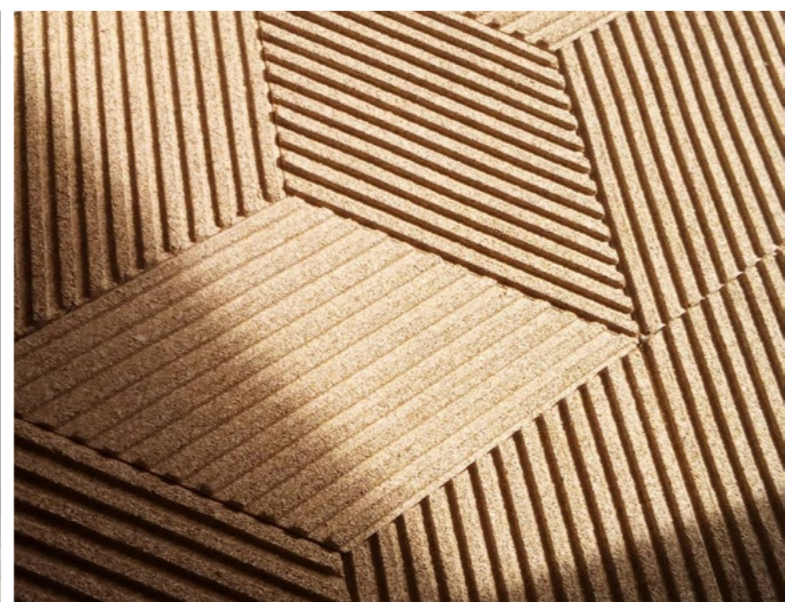
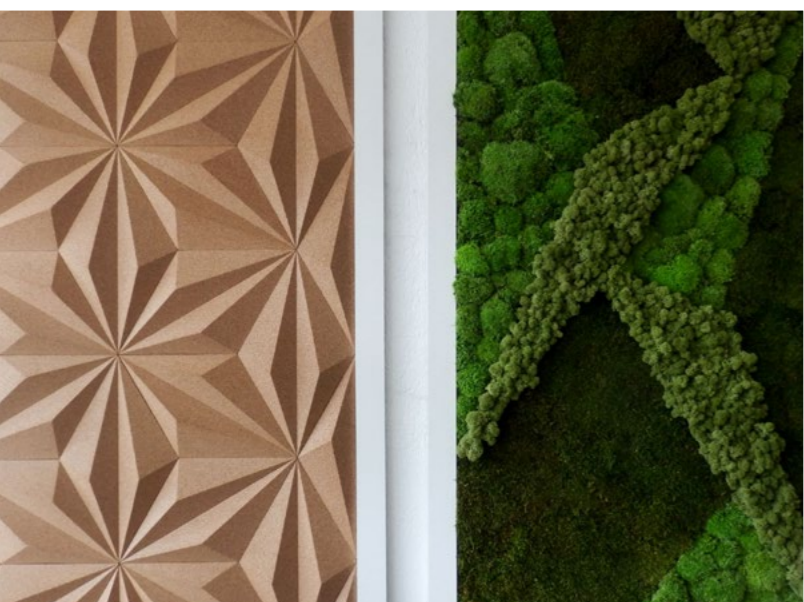
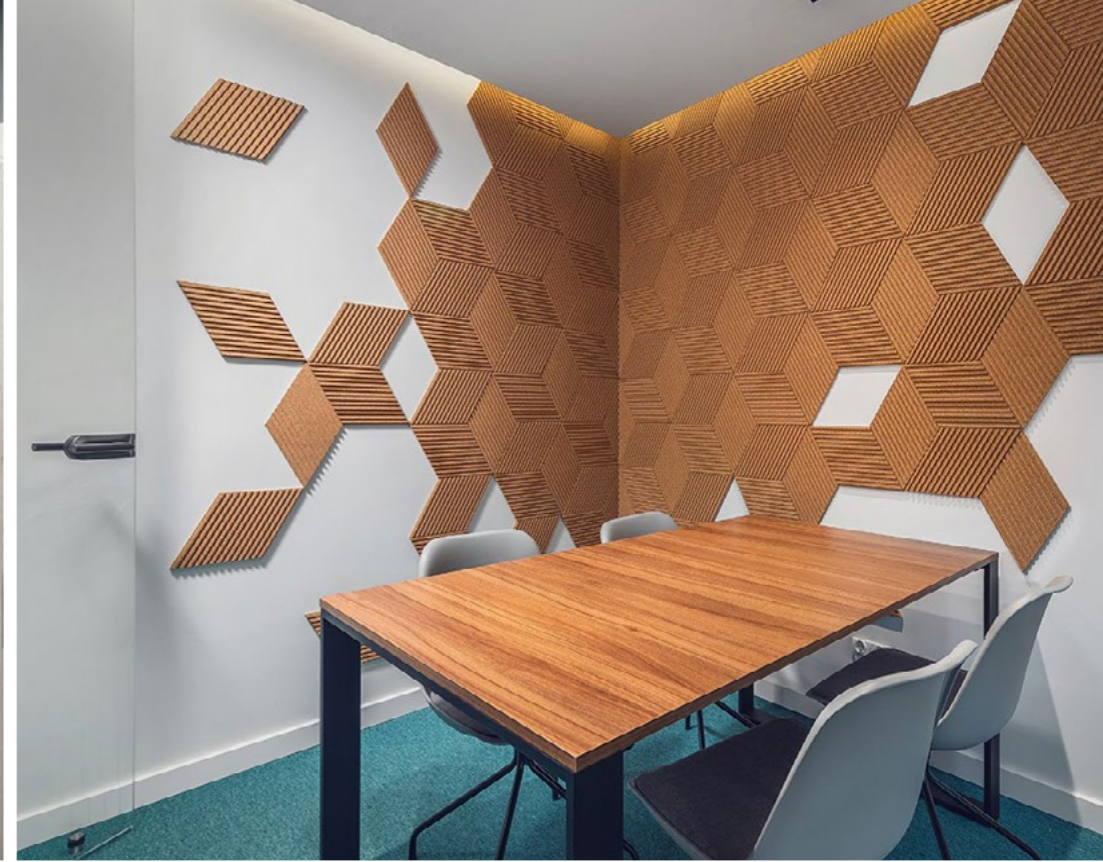
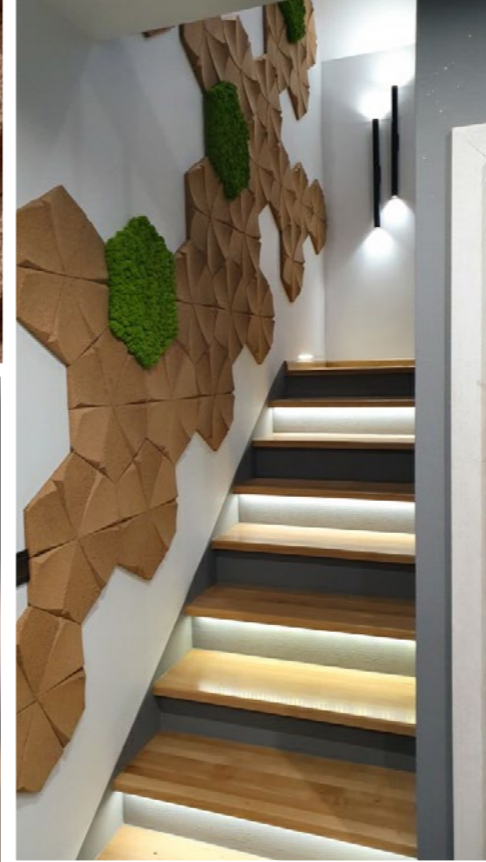

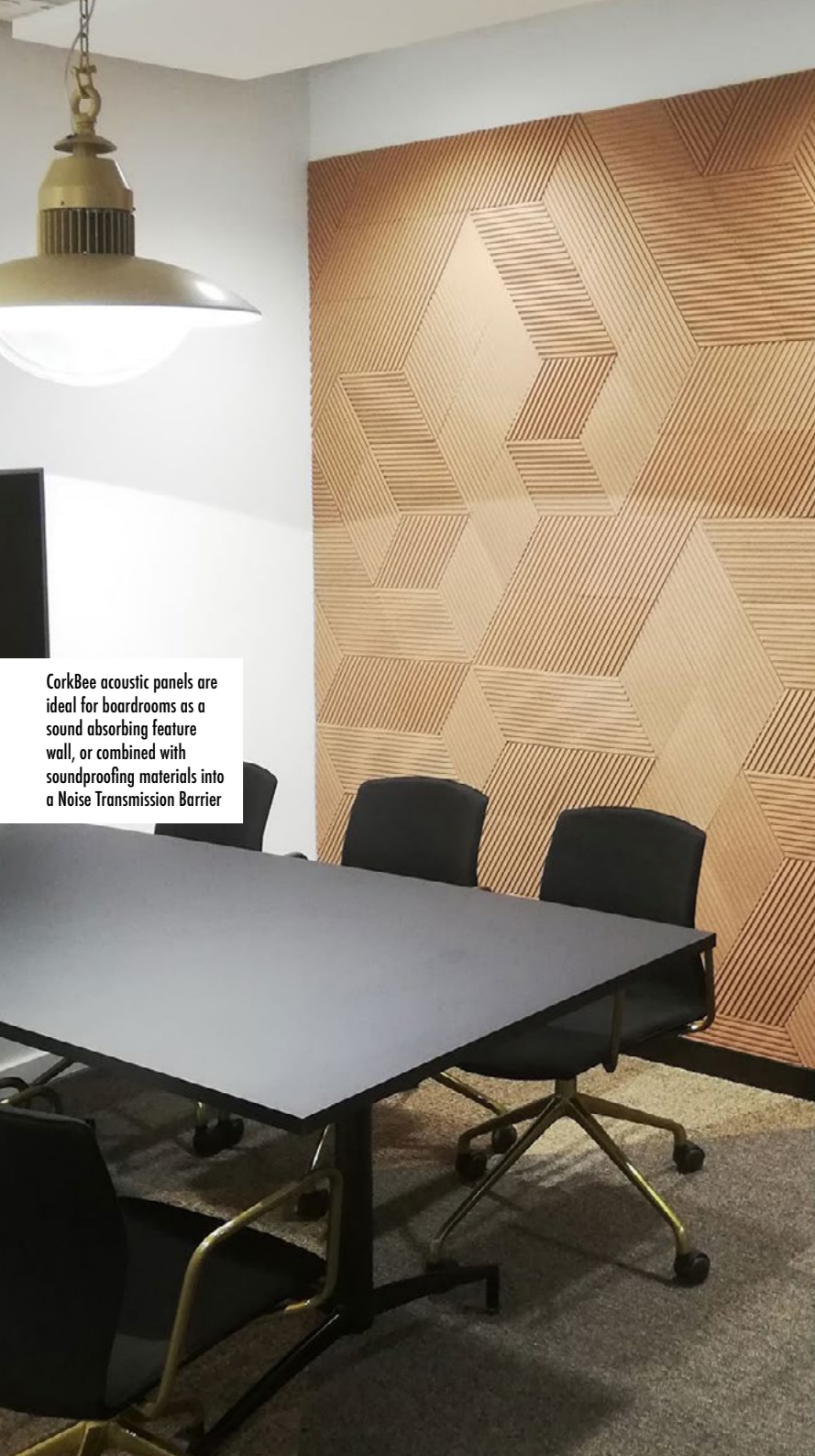

CorkBee acoustic panels are ideal for boardrooms as a sound absorbing feature wall, or combined with soundproofing materials into a Noise Transmission Barrier

# CORKBEE ACOUSTIC

CorkBee is the environmentally friendly solution to bad acoustics. Inspired by nature, these 3D wall panels tick all the right boxes – they are made from a renewable, recyclable and biodegradable material, that has a unique design and offers superior acoustic comfort.

CorkBee combines our passion for good design and simple forms to bring you a collection of environmentally friendly, 3D acoustic panels.

Cork is a tremendously versatile material that has excellent acoustic properties due to its porous nature. It is lightweight, durable, can be moulded into a variety of shapes and, best of all, completely organic!

CorkBee is sustainably sourced, the cork used is not extracted to make these acoustic panels, but is a by-product from the waste produced from the manufacturing of wine bottle corks.



Did you know that CorkBee acoustic panels are made of the by-product from the production of wine corks? I'll drink to that!



NATURAL

POSSIBILITIES OF INSTALLATION

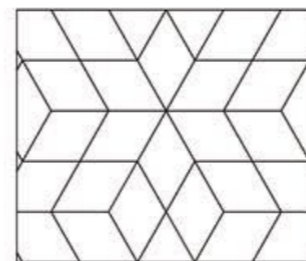
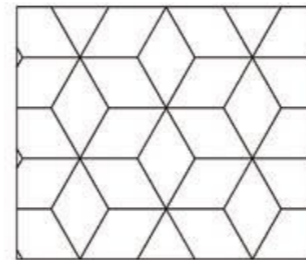
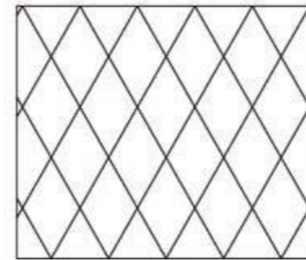
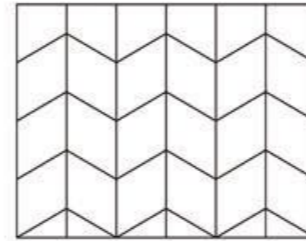

CorkBee  
**CONNECT**

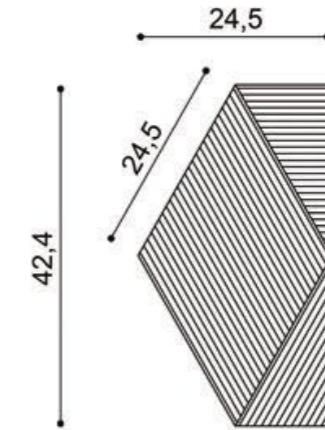

**PANELS PER PACK:** 3 pieces  
**PANELS PER M<sup>2</sup>:** 19 pieces  
**WEIGHT:** 230g Natural / 250g Colour  
**Thickness:** 5mm, rising to 10mm

COLOURS





NATURAL

POSSIBILITIES OF INSTALLATION

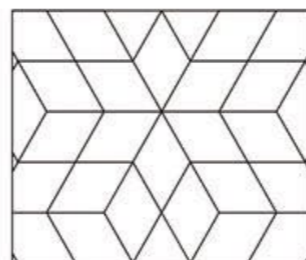
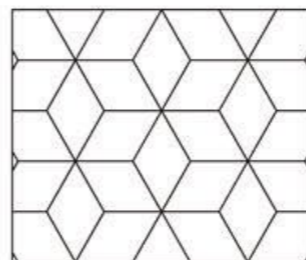
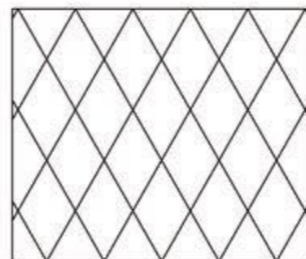
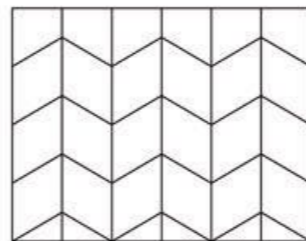

CorkBee  
**BLOOM**

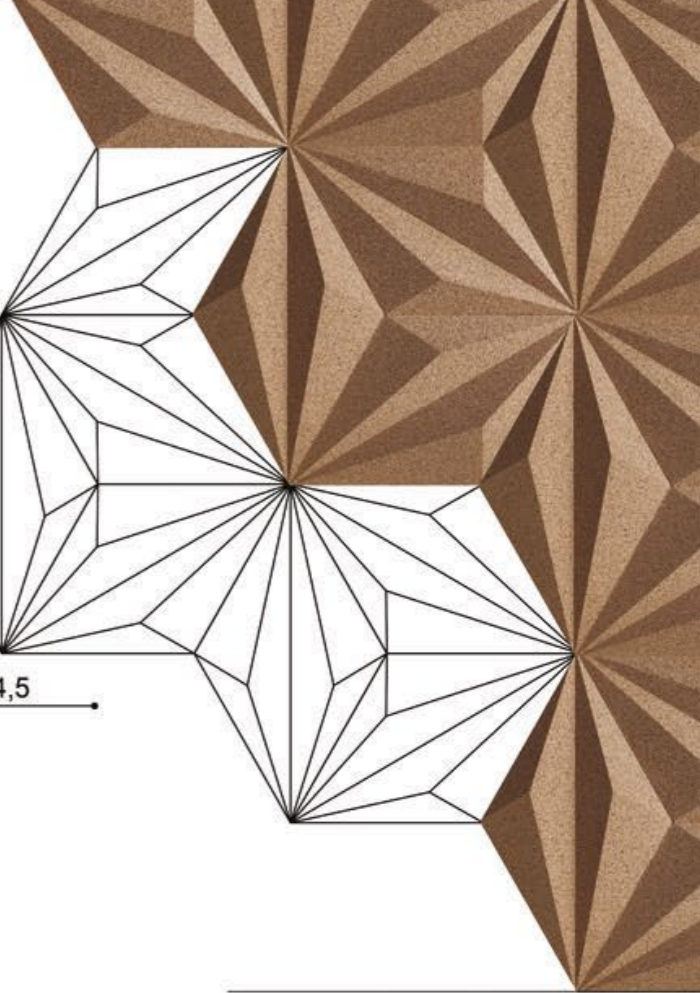
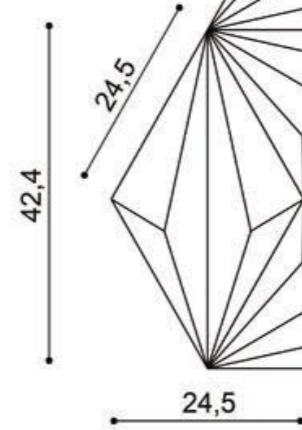

COLOURS

**PANELS PER PACK:** 3 pieces  
**PANELS PER M<sup>2</sup>:** 19 pieces  
**WEIGHT:** 230g Natural / 250g Colour  
**Thickness:** 5mm, rising to 30mm



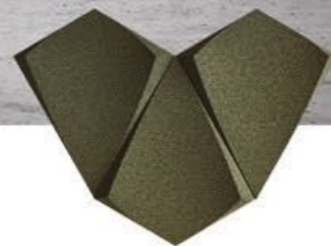

DARK GREEN

POSSIBILITIES OF INSTALLATION

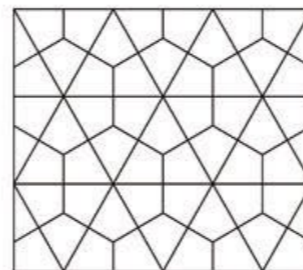
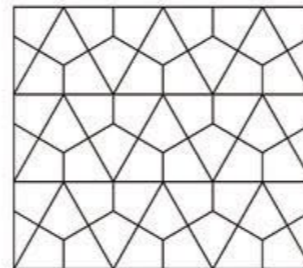
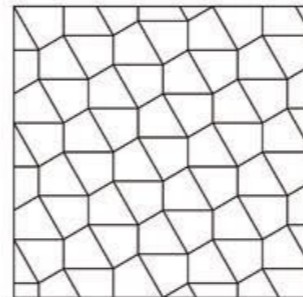
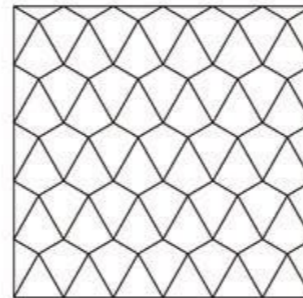

**CorkBee**  
**SHIELD**

**PANELS PER PACK:** 6 pieces  
**PANELS PER M<sup>2</sup>:** 40 pieces  
**WEIGHT:** 150g Natural / 180g Colour  
**THICKNESS:** 20mm, rising to 30mm

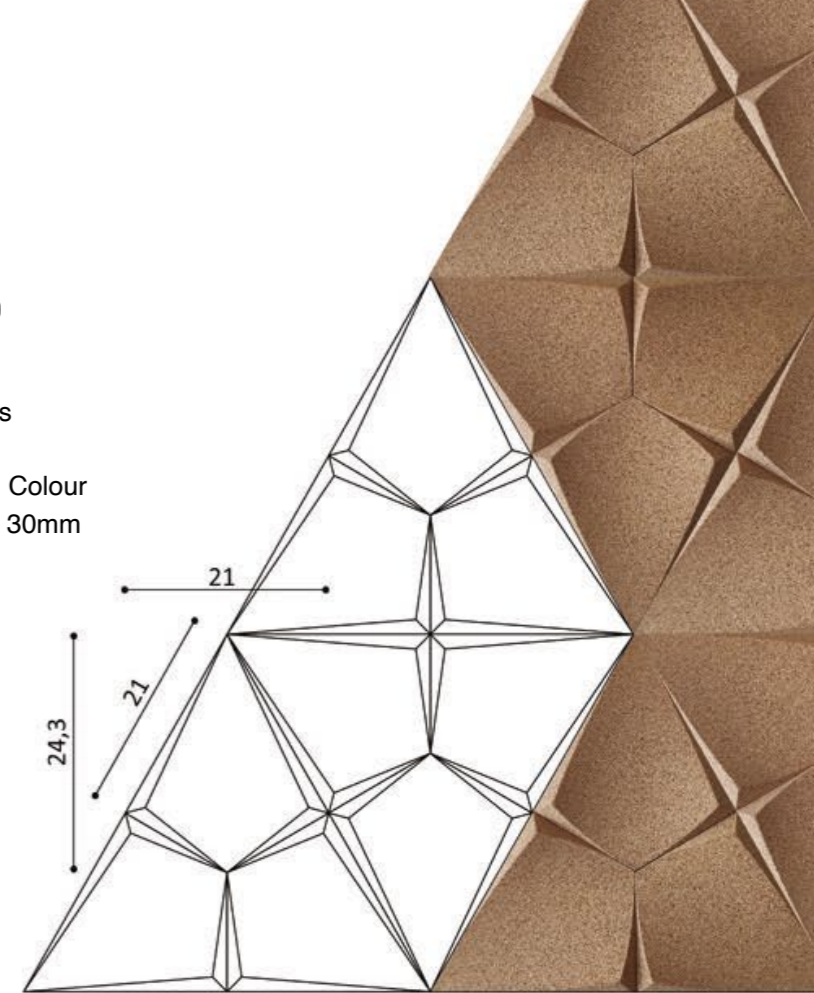

COLOURS





GREY

## POSSIBILITIES OF INSTALLATION

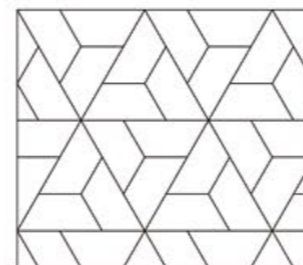
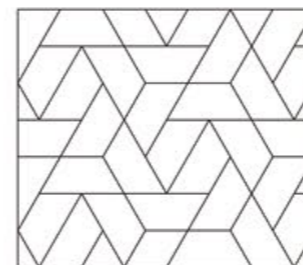
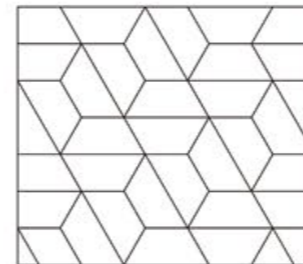
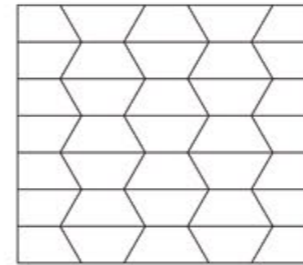

### CorkBee **WAVE**

**PANELS PER PACK:** 9 pieces

**PANELS PER M<sup>2</sup>:** 25 pieces

**WEIGHT:** 150g Natural / 180g Colour

**THICKNESS:** 5mm, rising to 15mm

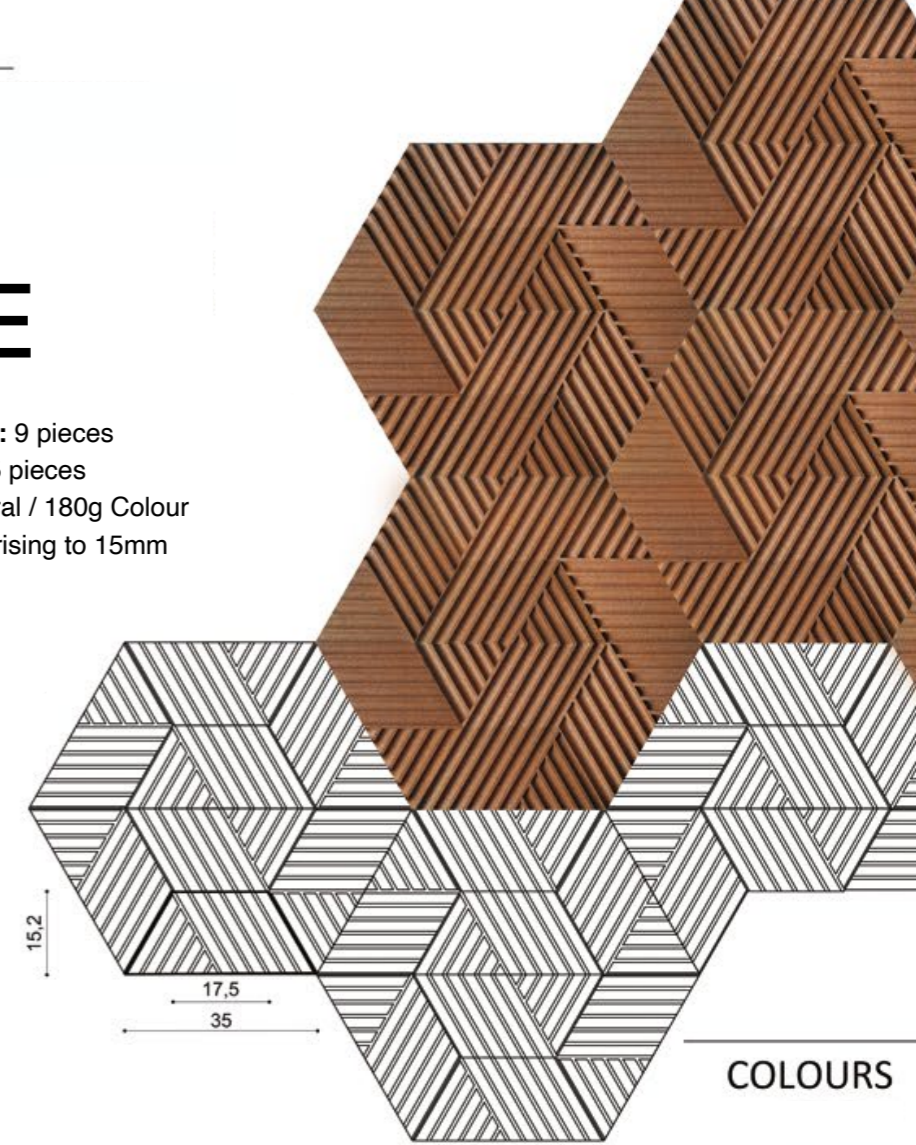

## COLOURS



IVORY



NATURAL



BROWN



YELLOW



GREY



MAROON



BLUE



DEEP BLUE



DARK GREN



GREEN



BLACK



GREEN

POSSIBILITIES OF INSTALLATION

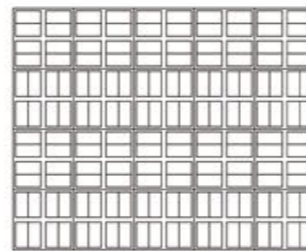
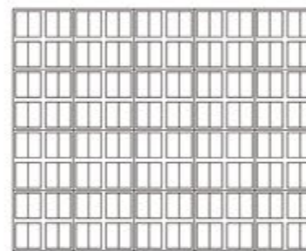
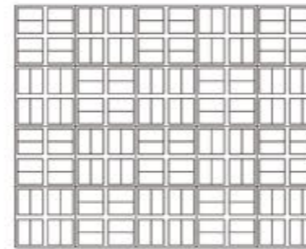
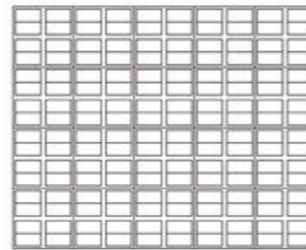

**CorkBee**  
**BLOCK**

**PANELS PER PACK:** 4 pieces  
**PANELS PER M<sup>2</sup>:** 16 pieces  
**WEIGHT:** 300g Natural / 340g Colour  
**THICKNESS:** 25mm

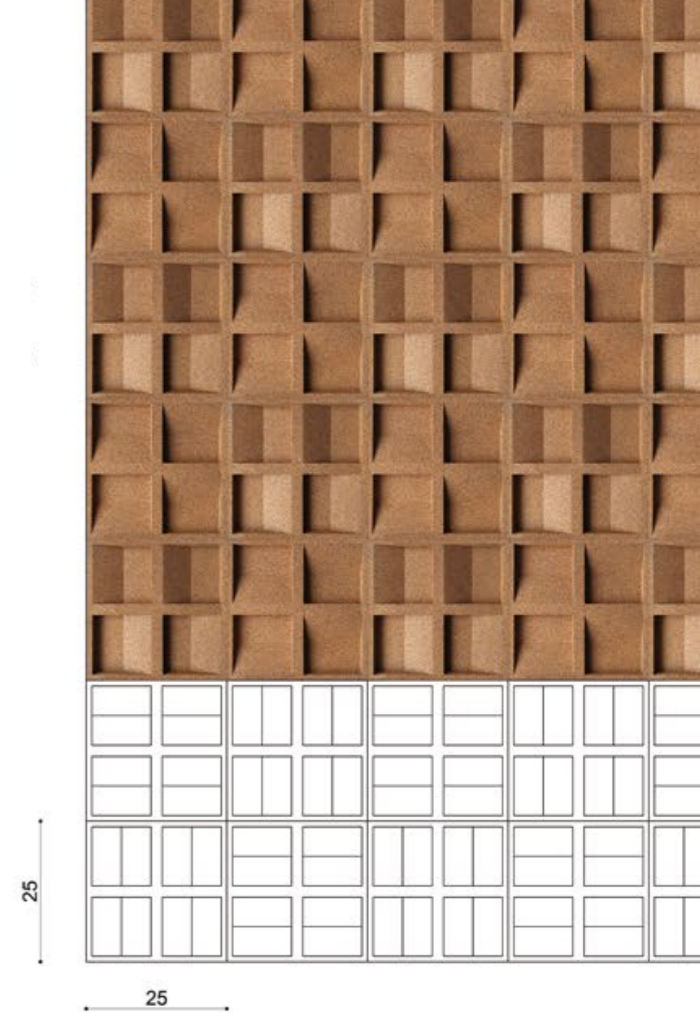

COLOURS



IVORY



NATURAL



BROWN



YELLOW



GREY



MAROON



BLUE



DEEP BLUE



DARK GREEN

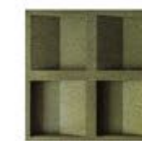

GREEN



BLACK

## CORKBEE ACOUSTIC PANEL RANGE

### CONNECT

Natural:  
£199.00m2  
Colour:  
£229.00m2

### BLOOM

Natural:  
£229.00m2  
Colour:  
£249.00m2

### SHIELD

Natural:  
£199.00m2  
Colour:  
£229.00m2

### WAVE

Natural:  
£259.00m2  
Colour:  
£279.00m2

### BLOCK

Natural:  
£229.00m2  
Colour:  
£249.00m2

Need it fire rated? An additive can be added when manufacturing for +£30m2

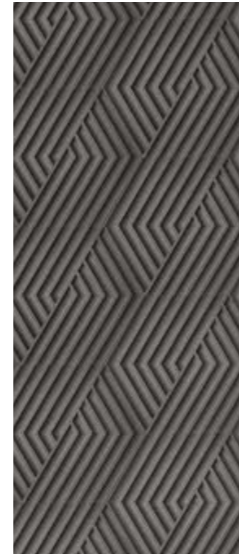
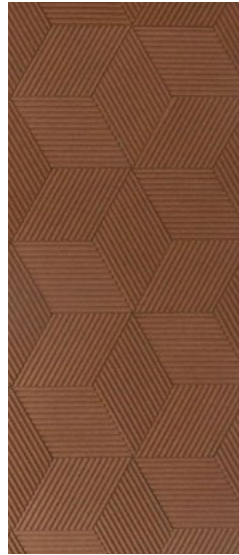

### Mix it up:

Keep things all natural by combining CorkBee with Moss Wall.



### Applications:

Ideal for a range of commercial spaces

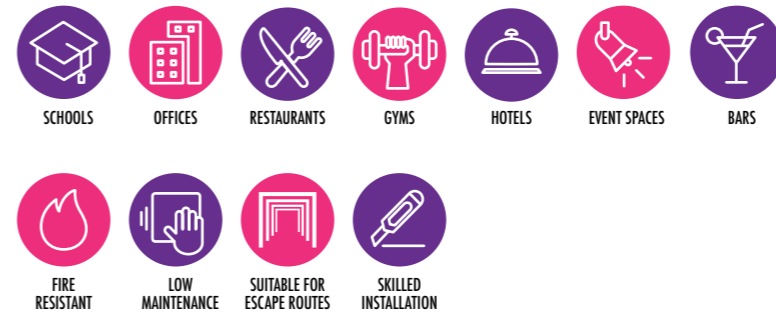

## SPECIFICATIONS

Acoustic rating (NRC/SAA): 0.29  
Absorption class: D  
Flammability class: N/A (additive available upon request)  
Supplied weight: 80 grams  
Density: 30kg / m<sup>3</sup>  
Building material class: A2-s1, d0 according to EN 13501-1  
Supplied dimensions: 424mm x 245mm  
Colours: 4 available  
Surface finish: Matte  
Thickness: 10mm - 20mm  
Environment: Certified to the EU Ecolabel Certified to Indoor Advantage™ Gold  
Sustainable: SKA, Leed & Well standard applicable  
VOC emissions - ASTM D5116  
Material: Compressed cork  
Colour fastness to light in accordance (ISO 105-B02): 6 (scale 1-8)  
Colour fastness to rubbing dry and wet (SO 105 X12) : 4/5 dry and wet  
Tear strength | Warp and weft (EN 29073-3): N/A  
Martindale (ISO 12947-2): N/A  
Supplied in white: YES  
Fixing type: Bonded adhesive  
Self install: YES  
Cutting method: Wood saw  
Supply lead time: 8-10 weeks  
Biodegradable: YES  
Recycled: YES  
Recyclable: YES  
Organic: YES  
Typical use: Indoor only, decorative with limited acoustic absorption



**SOUND**  
ZERO

[sound-zero.com](http://sound-zero.com)

[info@sound-zero.com](mailto:info@sound-zero.com) | 020 3984 2000