

Features & Benefits

- Selectable control input
- Over temperature protection with auto reset
- LED Indication
- Efficient electronic switching
- No additional heat sinks or RFI filters required

Technical Overview

The panel mounting Power Controllers RE-3P range are suitable for providing control of electric heating loads from an analogue signal. Applications include electric heating coils, heating cables and electric furnaces. The units utilise solid-state switching with "zero crossing technology" to provide accurate switching control.

All items are provided with an alarm output for over temperature protection and LED Indication of Output ON.

The RE-3P series are designed to mount on the control panel back plate.

Product Codes

RE-3P-27	27kW, 3-phase 37A (per phase), Panel Mount Heating Regulator
RE-3P-36	36kW, 3-phase 50A (per phase), Panel Mount Heating Regulator
RE-3P-57	57kW, 3-phase 80A (per phase), Panel Mount Heating Regulator
RE-3P-86	86kW, 3-phase 120A (per phase), Panel Mount Heating Regulator

Specification

Input signal	Selectable 0-10V, 5-5V, 2-10V or 4-20mA
Alarm output	24Vac alarm output, drops to 0V on alarm
Rated load:	
RE-3P-27	37A
RE-3P-36	50A
RE-3P-57	80A
RE-3P-86	120A
Dissipated heat:	
RE-3P-27	84W
RE-3P-36	100W
RE-3P-57	160W
RE-3P-86	250W
Rated supply	380 to 440Vac 50/60Hz
LED indication	ON when output is on (under main cover)
Terminals:	
Control	Rising cage terminals
Power	Din-rail terminals
Torque Settings (Power)	
RE-3P-27 & 36	2Nm minimum / 4Nm maximum
RE-3P-57 & 86	2.5Nm minimum / 5Nm maximum
Temperature	45°C Max, without re-rating *
Dimensions:	
RE-3P-27/36	257 x 102 x 142mm
RE-3P-57/86	257 x 200 x 158mm
Fixing centres:	
RE-3P-27/36	237 x 60mm
RE-3P-57/86	237 x 140mm
Conformity	CE Marked
Country of origin	UK

* Units are rated at 45°C. If using at higher ambient temp, de-rate the units by 10% for every 5°C above 45°C

WEEE Directive:

 At the end of the products useful life please dispose as per the local regulations.
Do not dispose of with normal household waste.
Do not burn.



The products referred to in this data sheet meet the requirements of EU 2014/30/EU and 2014/35/EU

SAFETY REQUIREMENTS & ADVICE SHEET

Introduction

The objective of this leaflet is to provide information to ensure that the safety of the person(s) installing or maintaining the equipment is not compromised and its location and method of installation does not endanger others, either during or after installation. Customers should be aware of the Health and Safety at Work Act 1974 (HSW 1974) and the EC "Provision and Use of Work Equipment Regulations 1992" (PUWER). Both are available from the Health and Safety Executive (HSE) publications, within the UK.

Installation

CE Directives

These are European regulations which apply to our industry. They affect the equipment emissions and immunity to Radio Frequency Interference (RFI) and various elements of safety for electrical equipment. The European Community 'CE' Directives that mainly concern Sontay Ltd are the Low Voltage Directive (LVD) and the Electromagnetic Compliance Directive (EMC). A Declaration of Conformity may be supplied with the product or supplied on request.

Torque Settings

See specification.

Cooling Requirements

The use of an additional heatsink (this could be a conductive panel) suitably attached or mounted with the unit, will help to dissipate heat away from the device(s). An alternative or additional method would be forced air-cooling (using a fan), to assist the natural convection of airflow over an existing heatsink within the unit. The product fins should be mounted in line with the forced and/or natural airflow. The equipment's environment and its initial ambient temperature also need to be considered, as this could have an adverse effect on the overall operating conditions.

Fusing

We recommend that semiconductor, fast acting to BS88 IEC 269, type fuses or circuit breakers (Semiconductor - MCB) should be used for unit and/or device protection. The appropriate maximum load current should be known to select the required fuse or MCB, but must not exceed the equipment rating. The $I^2 t$ ($A^2 s$) rating of the selected fuse must be less than that of the equipment so as to protect the equipment's discrete device. Further appropriate fusing may be required for protection of the unit supply using standard fuse links and holders. Failure to address these requirements and the use of incorrectly selected fuses may cause the equipment to fail.

Earthing

The protective conductor terminal of the equipment must be utilised at all times and bonded to a 'good' Earth (ground). The earth bonding (strapping) leads of any combined equipment should be as short as possible and be substantial, i.e. at least rated higher than the equipment's load. For further information, refer to BS7671. Following these simple guidelines will ensure optimum use of any appropriate filter circuits which may be required.

Insulation (over-voltage category) and Protection from electric shock Classification of Equipment

All equipment, unless otherwise stated, is rated to CLASS II Insulation (Over-voltage category) and CLASS I (Protection category).

Maintenance

Before any servicing is carried out, reference should be made to appropriate installation instructions, drawings and labelling which may come with the equipment. Personnel should switch off the unit supply before accessing or removing any safety cover and be aware of hazardous live parts.

Safety Interlocks for Sontay RE Electric Heater Battery Controllers

Sontay Ltd. recommends that the installation and maintenance of all RE electric heater battery controllers should be done with reference to BS 7671:2008+A3:2015 (Requirements for Electrical Installations. IET Wiring Regulations).

All users of the IET Wiring Regulations should be aware of changes in Amendment No. 3 to the 17th Edition. Amendment No. 3 came into effect on 1 July 2015.

For international installations, please refer to local regulations for guidance.

Adherence to BS 7671, Chapter 42 (Protection Against Thermal Effects), and in particular;

- 420.3 – General Requirements,
- 421 – Protection Against Fire Caused by Electrical Equipment
 - 421.1
 - 412.2
- 422 – Precautions Where Particular Risks of Fire Exist
 - 422.1.2
 - 422.1.3

should be undertaken, and as a minimum, a mains isolation switch, a load-breaker switch and a contact breaker should be installed in the electric heater battery controller supply. The supply to the contactor coil should be interrupted by an over-temperature (hi-limit) thermostat located in the heater battery and also upon detection of airflow loss (fan proving), via an air flow switch, air DP switch across the fan or fan current switch in the fan supply.

SAFETY REQUIRMENTS & ADVICE SHEET (continued)

Additionally, EN 61508-1:2010 (Functional safety of electrical/electronic/ programmable electronic safety-related systems. General requirements) stipulates the general requirements for electrical, electronic and programmable electronic safety devices, and covers the safety systems of electrical equipment and their components that could have an impact on the safety of people and the environment if they fail. BS EN 61508-1 also applies to protection and control systems, and helps organisations to identify hazards to improve overall equipment safety in the workplace.

Failure to incorporate these safety interlocks may result in the invalidation of fire insurance, building and contents insurance, and in extreme cases may result in the disconnection of the electrical supply by the distributor.

Operation, Installation & Configuration



Installation must be carried out by a suitably trained electrician, and in accordance with the relevant statutory regulations.

The RE-3P series has been designed to control electric heating loads in proportion to the incoming, selectable analogue signal. Control of the load is facilitated by the use of solid-state semiconductor devices and feature zero crossing point switching of the AC load which virtually eliminates RFI problems.

Caution

In normal operation the heat sink surface can exceed 90°C.

Dangerous voltages exist on the PCB and particular care should be taken. The RE-3P must be installed in accordance with the relevant statutory regulations and installation must be carried out by an experienced and fully qualified engineer.

Ventilation

The RE-3P are suitable for use up to a maximum ambient temperature of 45°C which should not be exceeded. If necessary, enclosures or control panels should be ventilated with a cooling fan, particularly if the unit is being used to run at full power to provide forced cool air movement over the heat sink.

Over Temperature Monitoring

The RE-3P is provided with an electronic thermal cut-out fitted to the heat sink to protect against over temperature. The unit will switch off the load if the heat sink temperature exceeds 95°C and will automatically reconnect the load once the heat sink temperature has dropped below 85°C. Upon switching, the alarm output from the control PCB will change from 24V to 0V.

The heat sink temperature will not reach 95°C under normal operating conditions. However, this might occur if the ambient temperature exceeds 45°C.

Load Supply and Back-up Protection

High speed fuses or miniature circuit breakers should be utilised to provide back-up protection to the switching devices. It is recommended that a load disconnect switch and a contactor are installed in the load supply. The supply to the contactor coil should be interrupted by an over-temperature thermostat located in the heater battery and also upon detection of airflow loss.

Control Supply

There is a transformer fitted to the unit removing the requirement for a 24V supply (see wiring for details).

The control supply common is linked to the 0-10V Input Signal common. Screened cable should be used for connections to BMS Controllers, where possible the cable screen should be connected to a functional earth and at one end only to avoid earth loops.

Cycle Time

The unit is supplied with the cycle time set to minimum (fully anticlockwise). An on board potentiometer is provided to facilitate adjustment of the cycle time in the range of 5 (default) to 60 seconds. Adjustment is not normally required, incorrect adjustment can cause an overload condition.

Maximum Heating Load

The power rating of the units are given as a guide. The maximum current (which is dependent on the actual supply voltage and heating load) must not be exceeded.

Jumper Settings & Connections

Voltage inputs:



IV Jumper

Current inputs:



IV Jumper

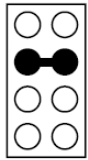

0-10Vdc

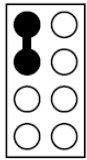

0-5Vdc

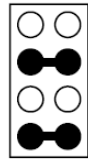

2-10Vdc

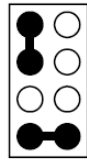

1-5Vdc

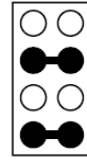

4-20mA

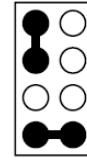

2-10mA

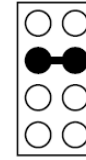

0-20mA

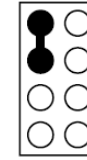

0-10mA

IV jumper

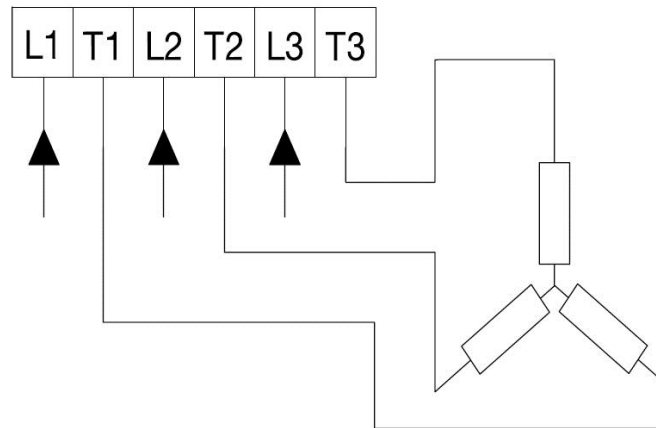
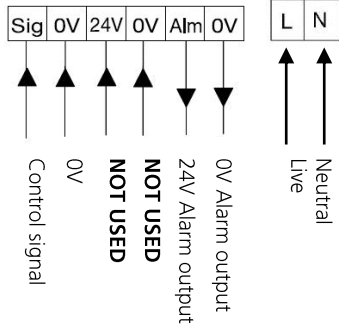
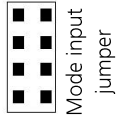

WARNING! Do **NOT** connect the neutral to the star point of heater.

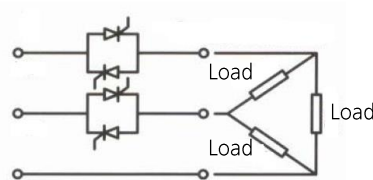
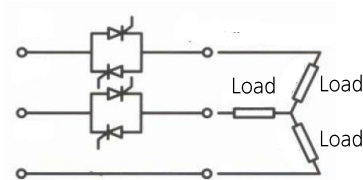

Whilst every effort has been made to ensure the accuracy of this specification, Sontay cannot accept responsibility for damage, injury, loss or expense from errors or omissions. In the interest of technical improvement, this specification may be altered without notice.