

## FLOOR TRACKS

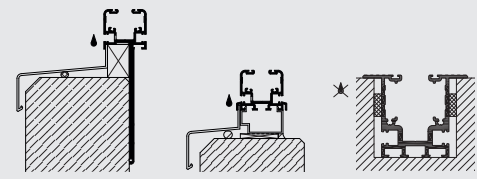

## CONFIGURATION VARIANTS

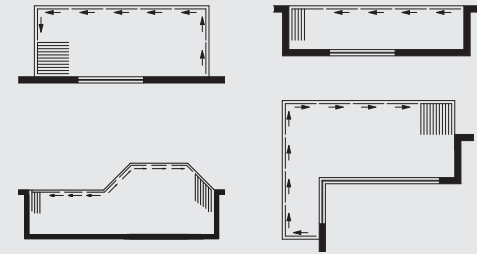

## VERTICAL SECTION

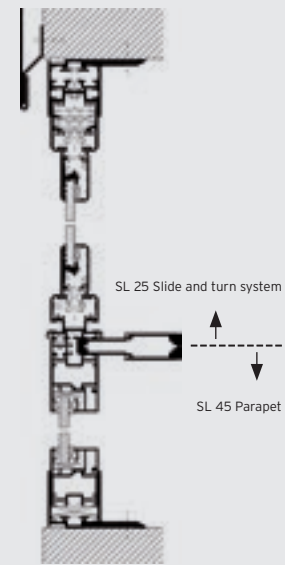

## PANEL SIZE CHART

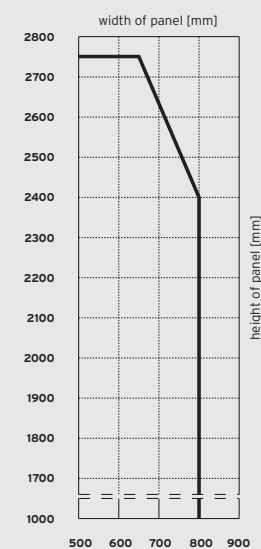

## VARIANTS

- Available as top hung panels
- Panels can be ordered to open either internally or externally, to the left and/or right

## PROFILE SYSTEM

- Profile thickness 27 mm
- All-glass slide and turn system
- In-line support, no vertical frames

## WINDOW SYSTEM

- Can be combined with SL 45 window system: parapets, fixed panels, tilt and turn

## FITTINGS

- No protruding runner and guide tracks
- Concealed fittings for one hand operation
- Integrated 2-step-locking
- Patented one handed operation by means of stainless steel cable control
- Child lock / lockable intruder protection (optional)
- Extensive layout options thanks to mobile carriage which can be manoeuvred through all angles from 90° - 180°
- No parking station for panels required

## GLAZING

- Glazing with single pane safety glass
- Glass thickness 6 or 8 mm available

## SURFACE FINISH

- Powder coating to RAL
- Anodised aluminium to EURAS

## MAXIMUM PANEL SIZES

- 800 x 2400 mm
- 650 x 2750 mm
- Special sizes on request
- The total element width is unlimited

## TESTED FOR

- European Technical Approval ETA-12/0262
- ift Certificate No. 106 31293, Resistance to wind load - wind load test static and dynamic



5670201900 / 062014 / subject to technical changes



SLIDE AND TURN SYSTEM  
SL 25



#### ENGINEERED

Horizontal twin ball bearing runner devices guarantee that window sashes can be slid open extremely smoothly.

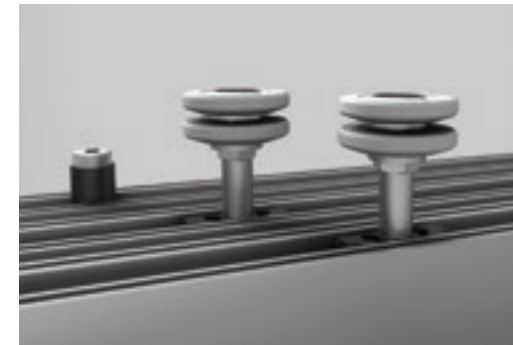

#### TRANSPARENCY

The all-glass slide and turn system is completely transparent whilst at the same time providing protection from rain and reducing noise (17db).

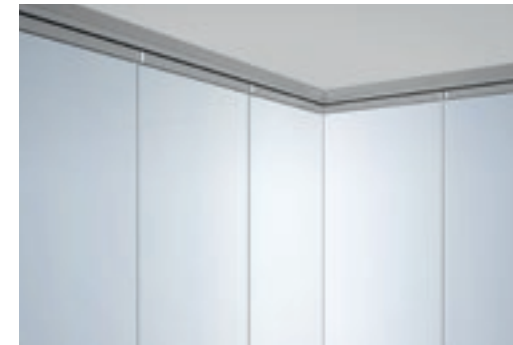

#### SECURITY

As an alternative to the cable release a brushed stainless steel door handle can be fitted for added security (optional).



#### WIDTH ADJUSTMENT

Width compensation up to 30 mm by means of adjustable frame and panel stops - important to compensate building tolerances.



#### HEIGHT ADJUSTMENT

The height compensation profile allows adjustment of up to 35 mm for the panels even after installation.

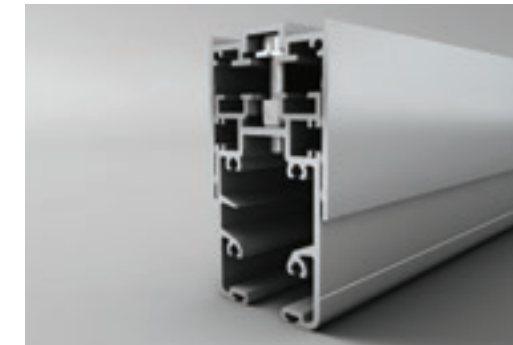

#### VENTILATION

The lockable two-step ventilation allows controlled air circulation (optional).

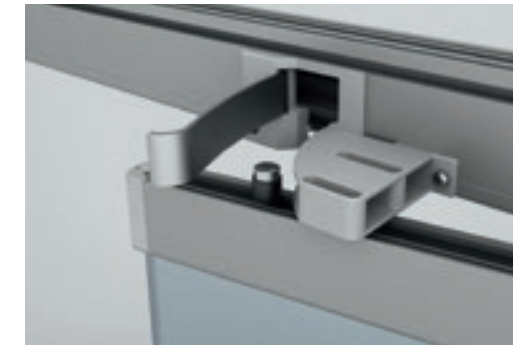

#### BARRIER FREE

The flush floor track ensures barrier free living for both patio or balcony. High security through pin and socket locking system.



#### CLEANING

Cleaning of the outer glass surface is easily carried out from the inside.

