

# **ROOF LIGHT**

*DAKRAAM  
TABATIERE  
DACHFENSTER  
ROOF LIGHT*

**DRa**

PROFIELEN . . . . . Pagina 7  
PROFILS . . . . . Page 7  
PROFILE . . . . . Seite 7  
PROFILES. . . . . Page 7

**DRb**

TOEBEHOREN . . . . . Pagina 15  
ACCESSOIRES. . . . . Page 15  
ZUBEHORTEILE . . . . . Seite 15  
ACCESSORIES. . . . . Page 15

**DRc**

DOORSNEDEN. . . . . Pagina 29  
COUPES . . . . . Page 29  
SCHNITT . . . . . Seite 29  
SECTIONS. . . . . Page 29

**DRd**

ALGEMENE INFORMATIE . . . . . Pagina 43  
INFORMATION GENERALE . . . . . Page 43  
ALGEMEINE INFORMATION . . . . . Seite 43  
GENERAL INFORMATION . . . . . Page 43

**DRe**

ZAAGTABELLEN . . . . . Pagina 45  
TABLES DE SCIAGES . . . . . Page 45  
ZUSCHNITT-TABELLEN . . . . . Seite 45  
SAWING TABLES . . . . . Page 45

**DRf**

WERKTEKENINGEN. . . . . Pagina 49  
DESSINS DE CONSTRUCTION . . . . . Page 49  
KONSTRUKTIONZEICHNUNGEN . . . . . Seite 49  
CONSTRUCTION DRAWINGS . . . . . Page 49





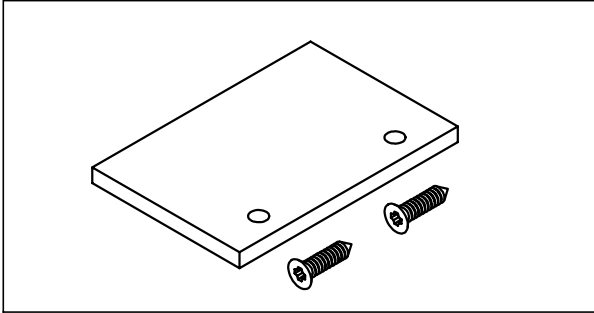





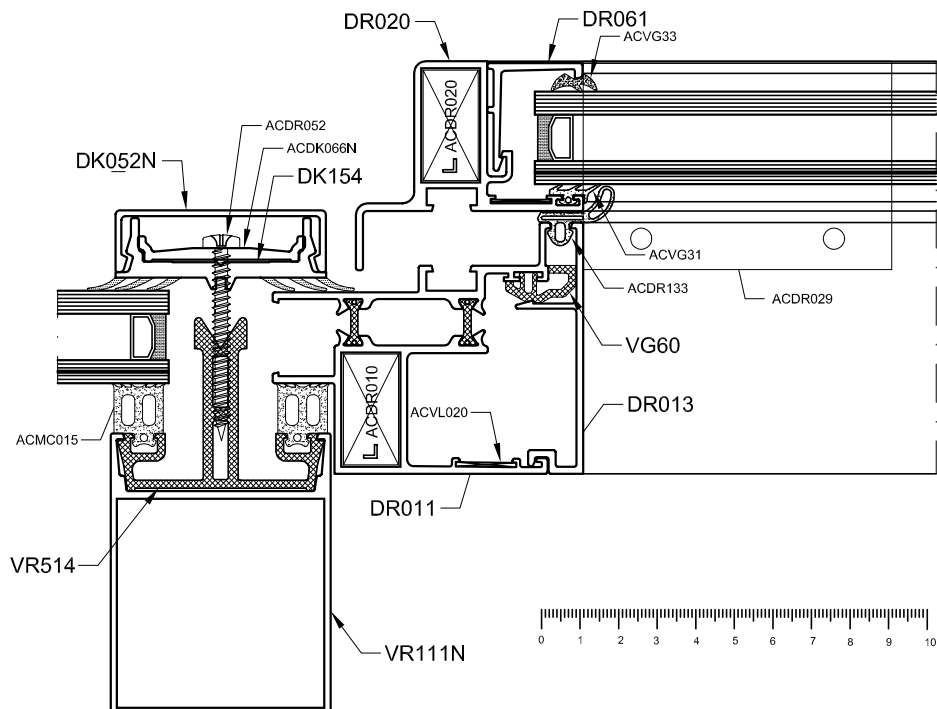
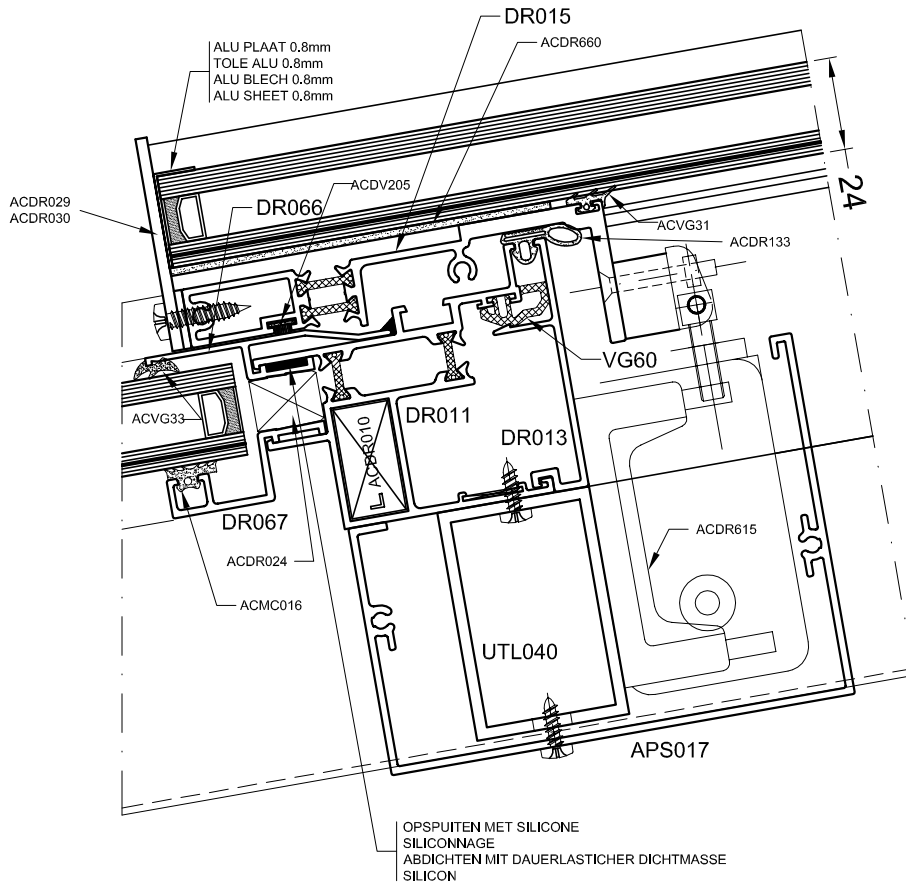







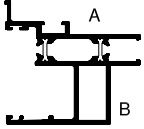

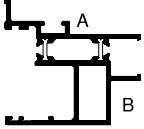
## ACDR029XX

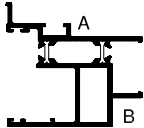
Extra glassteun  
Support de vitrage supplémentaire  
Extra Klotzbrücke  
Extra glazing support

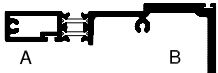

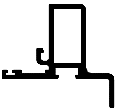

**PROFIELEN - PROFILS - PROFILE - PROFILES**

NUMMER NUMERO NUMBER	AFBEELDING IMAGE BILD PICTURE	BLAD PAGE SEITE PAGE	OMTREK PERIM. UMRIB PERIM. mm	MECH. MEC. MECH. MEC. mm	lxx cm4	lyy cm4	LENGTE LONG. LANGE LENGTH	VERP. PER EMB. PAR PACK PR. PACK PR.	BR	AN	KL	GS	M1
APS017	 	13	652	304	52.03	169.75	7	2	X	X	X	X	
DR010	 	7	460	109	21	19.9	4.5	2	X	X	X	X	X
DR011	 	8	459	101	21	19.9	4.5	2	X	X	X	X	X
DR012	 	8	459	93	21.5	19.9	4.5	2	X	X	X	X	X
DR013		9	204	76	-	-	4.5	4	X	X	X	X	
DR015 DR015/09	 	11	401	50	4.5	94.8	4.5 0.9	2	X	X	X	X	X
DR020	 	11	283	106	6.6	7	4.5	2	X	X	X	X	
DR040		10	122	44	-	-	4.5	10	X	X	X	X	
DR041		10	154	60	-	-	4.5	6	X	X	X	X	

BR = BRUT - BRUT - ROH - BRUT  
 AN = ANODISATIE - ANODISE - ELOXIERT - ANODISED  
 KL = STANDAARDKLEUREN - COULEUR STANDARD - BASIS FARBEN - BASIC COLORS  
 GS = GEMOFFELD SPECIAAL - LAQUE SPECIAL - SPECIALFARBE - SPECIAL COLOR  
 M1 = BICOLOR - BICOLOR - BICOLOR - BICOLOR









A = BUITEN - EXTERIEUR - AUSSEN - OUTSIDE  
 B = BINNEN - INTERIEUR - INNEN - INSIDE

18/3/02

 Blad  
 Page  
 Seite  
 Page

**3**

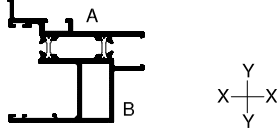
## PROFIELEN - PROFILS - PROFILE - PROFILES

NUMMER NUMERO NUMBER	AFBEELDING IMAGE BILD PICTURE	BLAD PAGE SEITE PAGE	OMTREK PERIM. UMRIB PERIM. mm	MECH. MEC. MECH. mm	lxx cm4	lyy cm4	LENGTE LONG. LANGE LENGTH	VERP. PER EMB. PAR PACK PR.	BR	AN	KL	GS	M1
DR060		10	66	26	-	-	4.5	10	X	X	X	X	
DR061		10	72	26	-	-	4.5	10	X	X	X	X	
DR062		10	78	26	-	-	4.5	6	X	X	X	X	
DR065		9	93	26	-	-	4.5	10	X	X	X	X	
DR066		9	190	45	-	-	4.5	6	X	X	X	X	
DR067		9	163	50	-	-	4.5	6	X	X	X	X	
DR910		7	427	-	21	19.9	4.5	2	X	X	X	X	X
DR960		10	100	-	-	-	4.5	10	X	X	X	X	
UTL007		12	80	80	-	-	6	10	X	X	X	X	





PROFIELEN - PROFILS - PROFILE - PROFILES

Primaire zichtbare zijde  
Face visible primaire  
Primär sichtbare Seite  
Primary visible side

Secundaire zichtbare zijde  
Face visible secondaire  
Secundär sichtbare Seite  
Secondary visible side

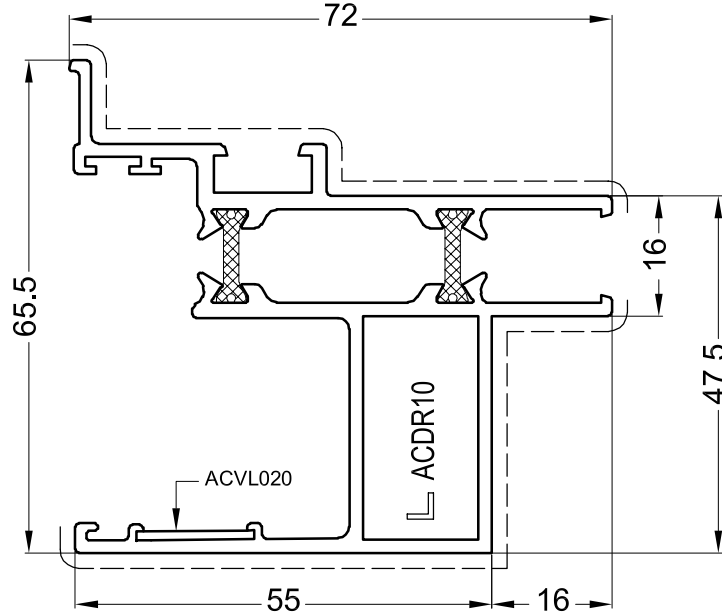

DR010

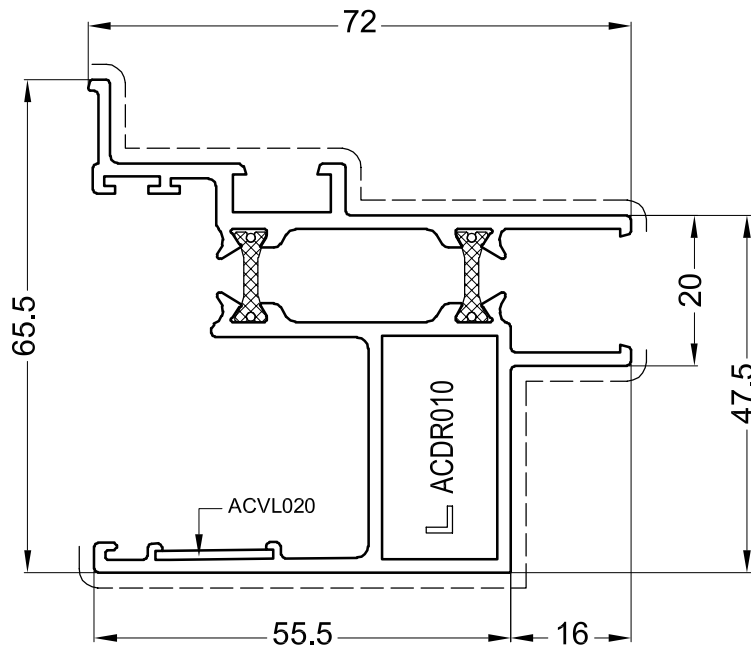

DR910

PROF01

## PROFIELEN - PROFILS - PROFILE - PROFILES

Primaire zichtbare zijde  
Face visible primaire  
Primär sichtbare Seite  
Primary visible side

Secundaire zichtbare zijde  
Face visible secondaire  
Secondär sichtbare Seite  
Secondary visible side

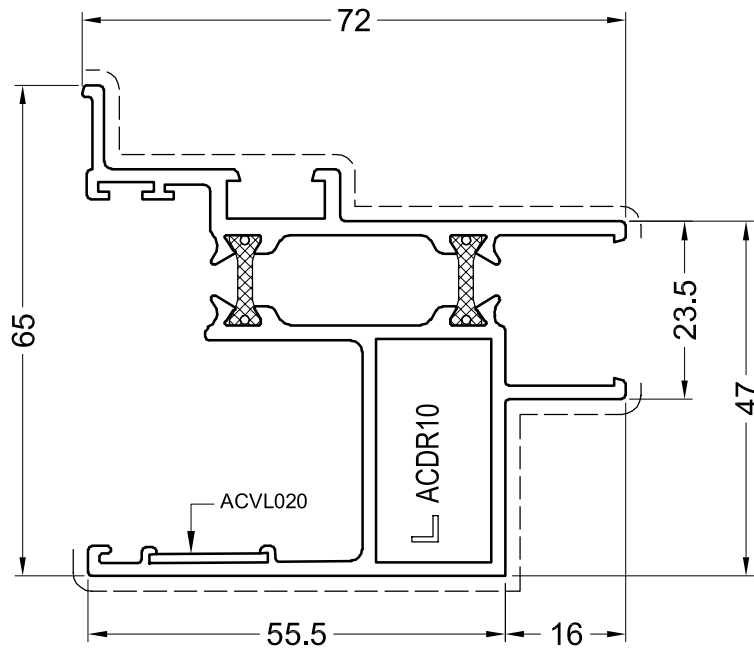

DR011

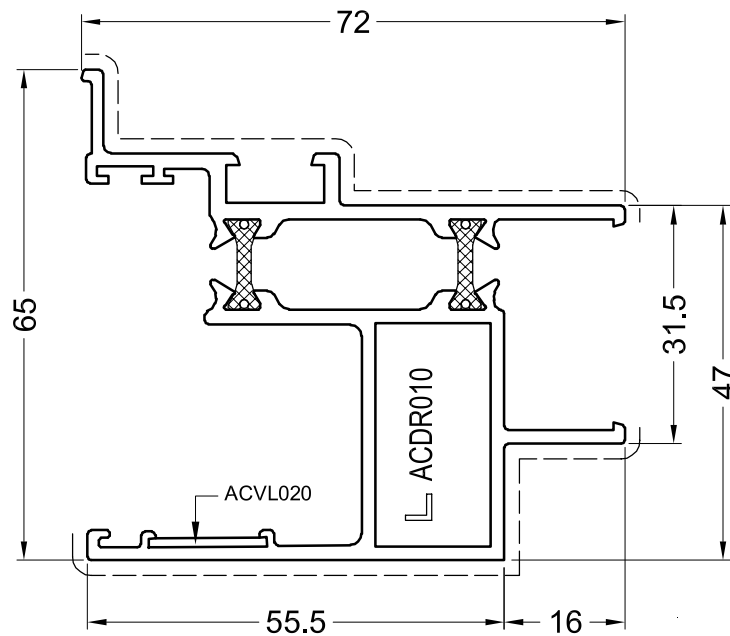

DR012

PROF02

PROFIELEN - PROFILS - PROFILE - PROFILES

Primaire zichtbare zijde  
Face visible primaire  
Primär sichtbare Seite  
Primary visible side

Secundaire zichtbare zijde  
Face visible secondaire  
Secundär sichtbare Seite  
Secondary visible side

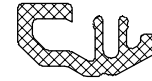
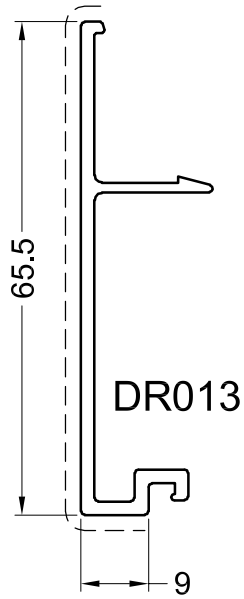

VG60

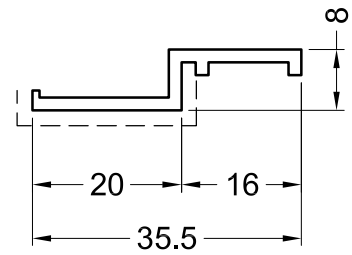

DR065

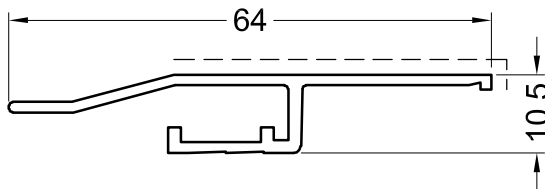

DR066

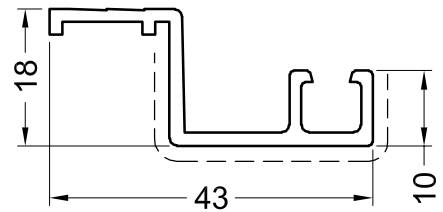

DR067

PROF03

PROFIELEN - PROFILS - PROFILE - PROFILES

Primaire zichtbare zijde  
Face visible primaire  
Primär sichtbare Seite  
Primary visible side

Secundaire zichtbare zijde  
Face visible secondaire  
Secondär sichtbare Seite  
Secondary visible side

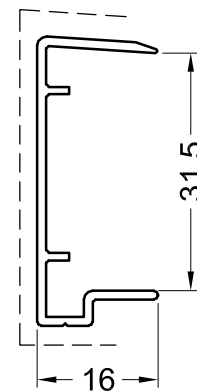
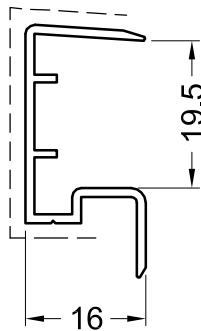
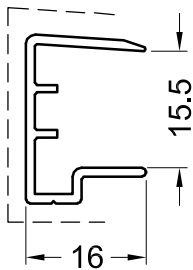
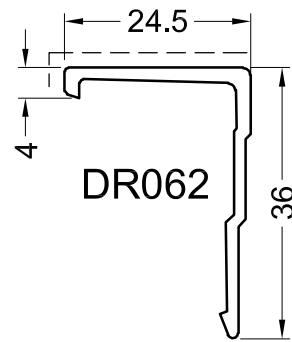
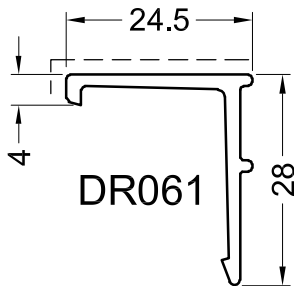
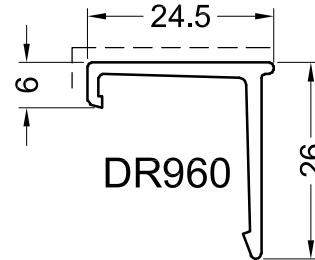
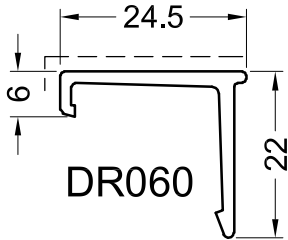

PROF04

PROFIELEN - PROFILS - PROFILE - PROFILES

Primaire zichtbare zijde  
Face visible primaire  
Primär sichtbare Seite  
Primary visible side

Secundaire zichtbare zijde  
Face visible secondaire  
Secundär sichtbare Seite  
Secondary visible side

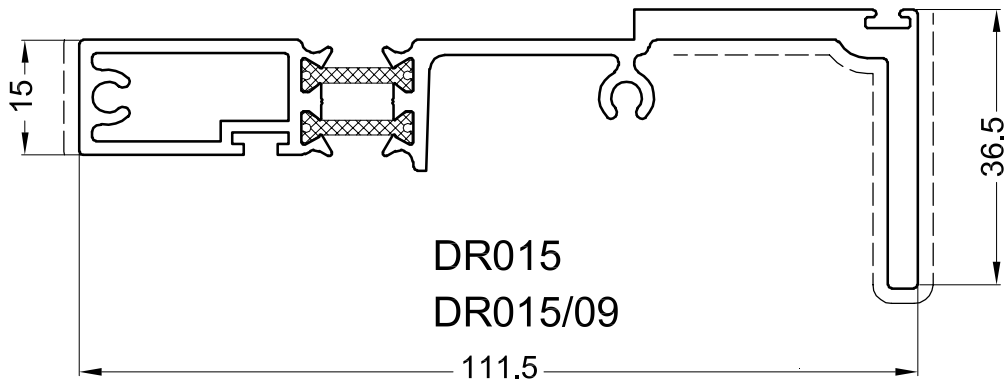
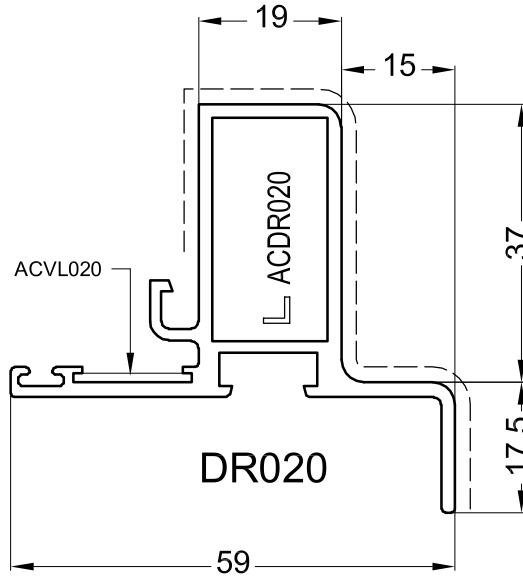

prof05

## PROFIELEN - PROFILS - PROFILE - PROFILES

Primaire zichtbare zijde  
Face visible primaire  
Primär sichtbare Seite  
Primary visible side

Secundaire zichtbare zijde  
Face visible secondaire  
Secundär sichtbare Seite  
Secondary visible side

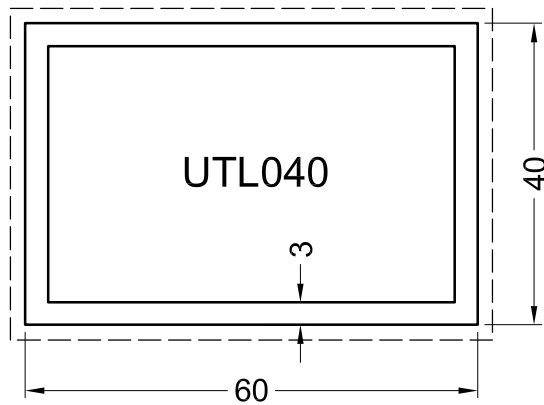
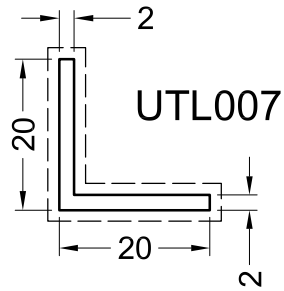

prof06

PROFIELEN - PROFILS - PROFILE - PROFILES

-----  
 Primaire zichtbare zijde  
 Face visible primaire  
 Primär sichtbare Seite  
 Primary visible side



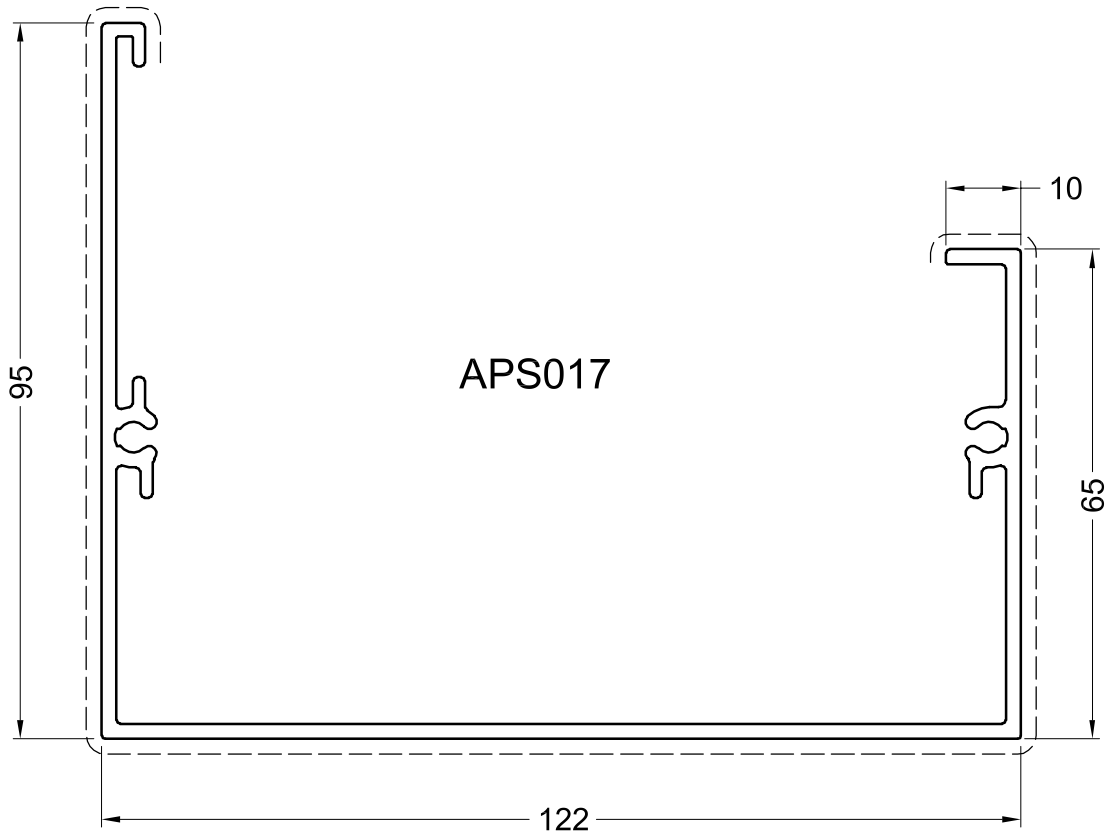

-----  
 Secondaire zichtbare zijde  
 Face visible secondaire  
 Secundär sichtbare Seite  
 Secondary visible side



prof07

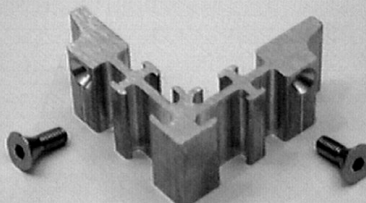

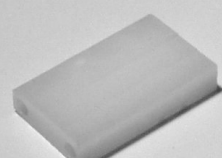
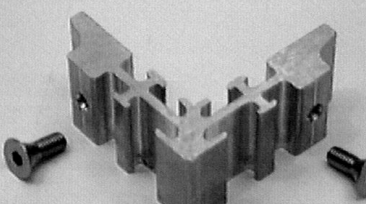

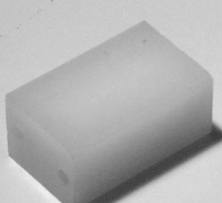
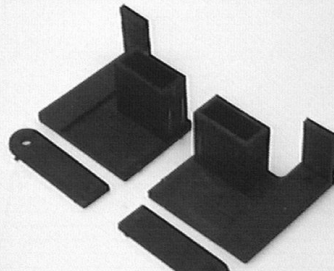

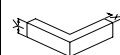
**TOEBEHOREN - ACCESSOIRES - ZUBEHÖRTEILE - ACCESSORIES**

	Verp. per Emb. par Pack pr.	Einheid Unit	Toepassing Application	Kleur Couleur Farbe Color												
 <p><b>ACDR010</b>                      -Schroefhoek voor DR010-11-12-910                      -Clame à visser pour DR010-11-12-910                      -Eckverbinder schraubbar für DR010-11-12-910                      -Square coupling joint for DR010-11-12-910</p> <p><b>X=15mm</b> <b>Y=30mm</b></p>  <b>ACDR921</b>	1 24	Stuk Pièce Stück Piece	DR010 DR011 DR012 DR910	<table border="1"> <tr><td>BR</td><td>X</td></tr> <tr><td>AN</td><td></td></tr> <tr><td>KL</td><td></td></tr> <tr><td>GS</td><td></td></tr> <tr><td>Z</td><td></td></tr> <tr><td>W</td><td></td></tr> </table>	BR	X	AN		KL		GS		Z		W	
BR	X															
AN																
KL																
GS																
Z																
W																
 <p><b>ACDR016</b>                      -Afstandhouder 16mm PVC                      -Entretoise 16mm PVC                      -Abstandstück 16mm PVC                      -Spacer 16mm PVC</p>	1	Stuk Pièce Stück Piece	DR010 DR065	<table border="1"> <tr><td>BR</td><td>X</td></tr> <tr><td>AN</td><td></td></tr> <tr><td>KL</td><td></td></tr> <tr><td>GS</td><td></td></tr> <tr><td>Z</td><td></td></tr> <tr><td>W</td><td></td></tr> </table>	BR	X	AN		KL		GS		Z		W	
BR	X															
AN																
KL																
GS																
Z																
W																
 <p><b>ACDR020</b>                      -Schroefhoek voor DR020                      -Clame à visser pour DR020                      -Eckverbinder schraubbar für DR020                      -Square coupling joint for DR020</p> <p><b>X=15mm</b> <b>Y=30mm</b></p>  <b>ACDR920</b>	1 24	Stuk Pièce Stück Piece	DR020	<table border="1"> <tr><td>BR</td><td>X</td></tr> <tr><td>AN</td><td></td></tr> <tr><td>KL</td><td></td></tr> <tr><td>GS</td><td></td></tr> <tr><td>Z</td><td></td></tr> <tr><td>W</td><td></td></tr> </table>	BR	X	AN		KL		GS		Z		W	
BR	X															
AN																
KL																
GS																
Z																
W																
 <p><b>ACDR024</b>                      -Afstandhouder 25mm PVC                      -Entretoise 24mm PVC                      -Abstandstück 24mm PVC                      -Spacer 24mm PVC</p>	1	Stuk Pièce Stück Piece	DR011 DR066 DR067	<table border="1"> <tr><td>BR</td><td>X</td></tr> <tr><td>AN</td><td></td></tr> <tr><td>KL</td><td></td></tr> <tr><td>GS</td><td></td></tr> <tr><td>Z</td><td></td></tr> <tr><td>W</td><td></td></tr> </table>	BR	X	AN		KL		GS		Z		W	
BR	X															
AN																
KL																
GS																
Z																
W																
 <p><b>ACDR030</b>                      -PVC eindstuk voor DR020                      -PVC embout pour DR020                      -PVC Endstück für DR020                      -PVC sealing sill member for DR020</p>	1	Set	DR020	<table border="1"> <tr><td>BR</td><td></td></tr> <tr><td>AN</td><td></td></tr> <tr><td>KL</td><td></td></tr> <tr><td>GS</td><td></td></tr> <tr><td>Z</td><td>X</td></tr> <tr><td>W</td><td>X</td></tr> </table>	BR		AN		KL		GS		Z	X	W	X
BR																
AN																
KL																
GS																
Z	X															
W	X															

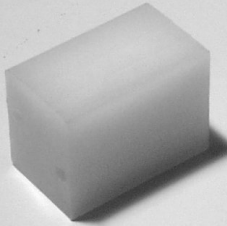
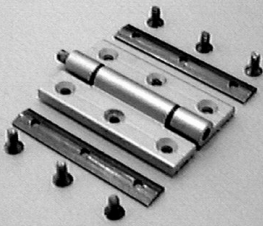

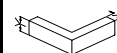

## TOEBEHOREN - ACCESSOIRES - ZUBEHÖRTEILE - ACCESSORIES

		Verp. per Emb. par Pack pr. Pack pr.	Eenheid Unité Einheit Unit	Toepassing Application Anwendung Application	Kleur Couleur Farbe Color												
	<b>ACDR031</b> -Dopje -Bouchon -Kapsel -Cap	1	Stuk	UTL040	<table border="1"> <tr><td>BR</td><td></td></tr> <tr><td>AN</td><td></td></tr> <tr><td>KL</td><td></td></tr> <tr><td>GS</td><td></td></tr> <tr><td>Z</td><td>X</td></tr> <tr><td>W</td><td>X</td></tr> </table>	BR		AN		KL		GS		Z	X	W	X
BR																	
AN																	
KL																	
GS																	
Z	X																
W	X																
	<b>ACDR032</b> -Afstandhouder 32mm PVC -Bouchon -Abdeckkappe -Cap	1	Stuk Pièce Stück Pièce	DR012 DR065	<table border="1"> <tr><td>BR</td><td>X</td></tr> <tr><td>AN</td><td></td></tr> <tr><td>KL</td><td></td></tr> <tr><td>GS</td><td></td></tr> <tr><td>Z</td><td></td></tr> <tr><td>W</td><td></td></tr> </table>	BR	X	AN		KL		GS		Z		W	
BR	X																
AN																	
KL																	
GS																	
Z																	
W																	
	<b>ACDR040</b> -Scharnier -Charnière -Band -Hinge	1	Stuk Pièce Stück Pièce	DR010 DR011 DR012 DR020	<table border="1"> <tr><td>BR</td><td></td></tr> <tr><td>AN</td><td>X</td></tr> <tr><td>KL</td><td></td></tr> <tr><td>GS</td><td></td></tr> <tr><td>Z</td><td></td></tr> <tr><td>W</td><td></td></tr> </table>	BR		AN	X	KL		GS		Z		W	
BR																	
AN	X																
KL																	
GS																	
Z																	
W																	
	<b>ACDR050</b> -Inox schroef DIN7981 4.8x32 -Vis en inox DIN7981 4.8x32 -Inox Schraube DIN7981 4.8x32 -Stainless steel screw DIN7981 4.8x32	200	Stuks Pièces Stücke Pieces	DR015 DR020	<table border="1"> <tr><td>BR</td><td>X</td></tr> <tr><td>AN</td><td></td></tr> <tr><td>KL</td><td></td></tr> <tr><td>GS</td><td></td></tr> <tr><td>Z</td><td></td></tr> <tr><td>W</td><td></td></tr> </table>	BR	X	AN		KL		GS		Z		W	
BR	X																
AN																	
KL																	
GS																	
Z																	
W																	
	<b>ACDR051</b> -Vijs DIN85 M5x10 met moer DIN934 M5 -Vis DIN85 M5x10 avec écrou DIN934 M5 -Schraube DIN85 M5x10 mit Mutter DIN934 M5 -Screw DIN85 M5x10 with bolt DIN934 M5	100	Stuks Pièces Stücke Pieces	DR015 DR020	<table border="1"> <tr><td>BR</td><td>X</td></tr> <tr><td>AN</td><td></td></tr> <tr><td>KL</td><td></td></tr> <tr><td>GS</td><td></td></tr> <tr><td>Z</td><td></td></tr> <tr><td>W</td><td></td></tr> </table>	BR	X	AN		KL		GS		Z		W	
BR	X																
AN																	
KL																	
GS																	
Z																	
W																	
	 <b>ACDR921</b>  <b>DIN7982 M4x20</b>																

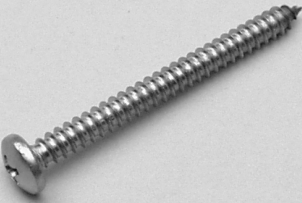
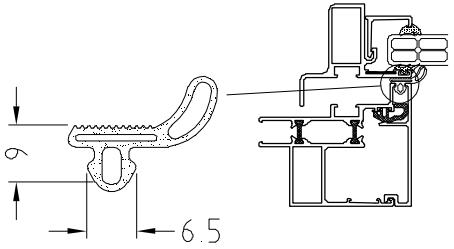

**TOEBEHOREN - ACCESSOIRES - ZUBEHORTEILE - ACCESSORIES**

	Verp. per Emb. par Pack pr.	Einheid Unit	Toepassing Application	Kleur Couleur												
	200	Stuks Pièces Stücke Pieces	DR015 DR020	<table border="1"> <tr><td>BR</td><td>X</td></tr> <tr><td>AN</td><td></td></tr> <tr><td>KL</td><td></td></tr> <tr><td>GS</td><td></td></tr> <tr><td>Z</td><td></td></tr> <tr><td>W</td><td></td></tr> </table>	BR	X	AN		KL		GS		Z		W	
BR	X															
AN																
KL																
GS																
Z																
W																
	25	m	DR010 DR011 DR012	<table border="1"> <tr><td>BR</td><td></td></tr> <tr><td>AN</td><td></td></tr> <tr><td>KL</td><td></td></tr> <tr><td>GS</td><td></td></tr> <tr><td>Z</td><td>X</td></tr> <tr><td>W</td><td></td></tr> </table>	BR		AN		KL		GS		Z	X	W	
BR																
AN																
KL																
GS																
Z	X															
W																
	1	Stuk Pièce Stück Piece	DR015	<table border="1"> <tr><td>BR</td><td>X</td></tr> <tr><td>AN</td><td></td></tr> <tr><td>KL</td><td></td></tr> <tr><td>GS</td><td></td></tr> <tr><td>Z</td><td></td></tr> <tr><td>W</td><td></td></tr> </table>	BR	X	AN		KL		GS		Z		W	
BR	X															
AN																
KL																
GS																
Z																
W																

 **DIN7981**

BR = BRUT - BRUT - ROH - BRUT  
 AN = ANODISATIE - ANODISE - ELOXIERT - ANODISED  
 KL = STANDAARDKLEUREN - COULEUR STANDARD - BASIS FARBEN - BASIC COLORS  
 GS = GEMOFFELD SPECIAAL - LAQUE SPECIAL - SPECIALFARBE - SPECIAL COLOR  
 Z = ZWART - NOIR - SCHWARZ - BLACK  
 W = WIT - BLANC - WEISS - WHITE



GEREEDSCHAP - OUTILLAGE  
 WERKZEUG - TOOL



BEVESTIGING - FIXATION  
 BEFESTIGUNG - FIXATION

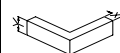

## TOEBEHOREN - ACCESSOIRES - ZUBEHÖRTEILE - ACCESSORIES

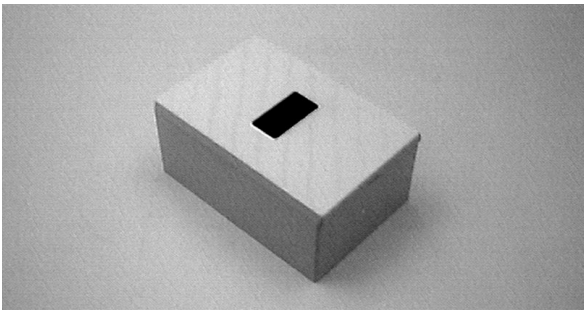
	Verp. per Emb. par Pack pr. Pack pr.	Eenheid Unité Einheit Unit	Toepassing Application Anwendung Application	Kleur Couleur Farbe Color												
	1	Stuk Pièce Stück Piece	ACDR610	<table border="1"> <tr> <td>BR</td> <td>X</td> </tr> <tr> <td>AN</td> <td></td> </tr> <tr> <td>KL</td> <td></td> </tr> <tr> <td>GS</td> <td></td> </tr> <tr> <td>Z</td> <td></td> </tr> <tr> <td>W</td> <td></td> </tr> </table>	BR	X	AN		KL		GS		Z		W	
				BR	X											
AN																
KL																
GS																
Z																
W																
<p><b>ACDR611</b></p> <p>-Bedieningsstang voor ACDR610 L=1500mm -Perche de manoeuvre pour ACDR610 L=1500mm -Bedienungsstange für ACDR610 L=1500mm -Operating stick for ACDR610 L=1500mm</p> <p><b>ACDR611-3L</b></p> <p>-Bedieningsstang voor ACDR610 L=3000mm -Perche de manoeuvre pour ACDR610 L=3000mm -Bedienungsstange für ACDR610 L=3000mm -Operating stick for ACDR610 L=3000mm</p>	1	Stuk Pièce Stück Piece	ACDR615	<table border="1"> <tr> <td>BR</td> <td></td> </tr> <tr> <td>AN</td> <td>X</td> </tr> <tr> <td>KL</td> <td></td> </tr> <tr> <td>GS</td> <td></td> </tr> <tr> <td>Z</td> <td>X</td> </tr> <tr> <td>W</td> <td>X</td> </tr> </table>	BR		AN	X	KL		GS		Z	X	W	X
BR																
AN	X															
KL																
GS																
Z	X															
W	X															
	1	Stuk Pièce Stück Piece	ACDR630A	<table border="1"> <tr> <td>BR</td> <td>X</td> </tr> <tr> <td>AN</td> <td></td> </tr> <tr> <td>KL</td> <td></td> </tr> <tr> <td>GS</td> <td></td> </tr> <tr> <td>Z</td> <td></td> </tr> <tr> <td>W</td> <td></td> </tr> </table>	BR	X	AN		KL		GS		Z		W	
BR				X												
AN																
KL																
GS																
Z																
W																
	1	Stuk Pièce Stück Piece	ACDR633	<table border="1"> <tr> <td>BR</td> <td>X</td> </tr> <tr> <td>AN</td> <td></td> </tr> <tr> <td>KL</td> <td></td> </tr> <tr> <td>GS</td> <td></td> </tr> <tr> <td>Z</td> <td></td> </tr> <tr> <td>W</td> <td></td> </tr> </table>	BR	X	AN		KL		GS		Z		W	
BR				X												
AN																
KL																
GS																
Z																
W																
<p>-Electrische motor manuele bediening 36kg - 220V -Moteur électrique manuel 36kg - 220V -Elektrischen Motor manuell 36kg - 220V -Electric motor manual 36kg - 220V</p>	1	Stuk Pièce Stück Piece	ACDR633	<table border="1"> <tr> <td>BR</td> <td>X</td> </tr> <tr> <td>AN</td> <td></td> </tr> <tr> <td>KL</td> <td></td> </tr> <tr> <td>GS</td> <td></td> </tr> <tr> <td>Z</td> <td></td> </tr> <tr> <td>W</td> <td></td> </tr> </table>	BR	X	AN		KL		GS		Z		W	
BR				X												
AN																
KL																
GS																
Z																
W																
<p>-Opbouwdoos voor 1 schakelaar -Boîtier applicable pour 1 interrupteur -Aufbaubüchse für 1 Schalter -Surface mounting box for 1 switch</p>	1	Stuk Pièce Stück Piece	ACDR633	<table border="1"> <tr> <td>BR</td> <td>X</td> </tr> <tr> <td>AN</td> <td></td> </tr> <tr> <td>KL</td> <td></td> </tr> <tr> <td>GS</td> <td></td> </tr> <tr> <td>Z</td> <td></td> </tr> <tr> <td>W</td> <td></td> </tr> </table>	BR	X	AN		KL		GS		Z		W	
BR				X												
AN																
KL																
GS																
Z																
W																

BR = BRUT - BRUT - ROH - BRUT  
AN = ANODISATIE - ANODISE - ELOXIERT - ANODISED  
KL = STANDAARDKLEUREN - COULEUR STANDARD - BASIS FARBEN - BASIC COLORS  
GS = GEMOFFELD SPECIAAL - LAQUE SPECIAL - SPECIALFARBE - SPECIAL COLOR  
Z = ZWART - NOIR - SCHWARZ - BLACK  
W = WIT - BLANC - WEISS - WHITE





GEREEDSCHAP - OUTILLAGE  
WERKZEUG - TOOL

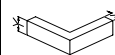

BEVESTIGING - FIXATION  
BEFESTIGUNG - FIXATION



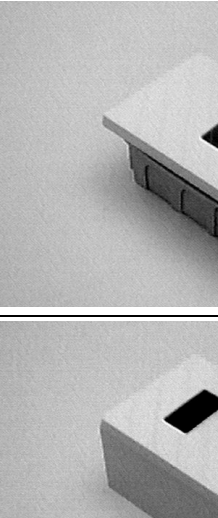
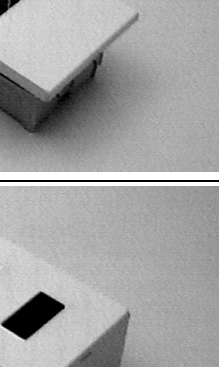
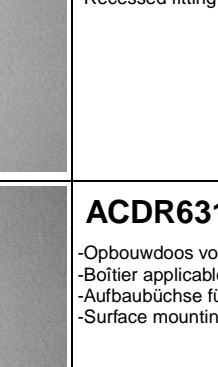

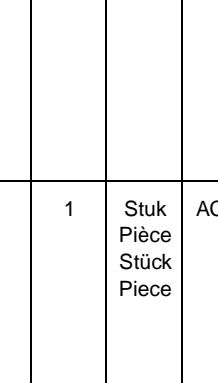
**TOEBEHOREN - ACCESSOIRES - ZUBEHORTEILE - ACCESSORIES**

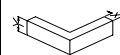
	Verp. per Emb. par Pack pr.	Einheid Unit	Toepassing Application	Kleur Couleur Farbe Color												
 <p><b>ACDR630B</b> -Inbouwdoos voor 1 schakelaar -Boîtier à encastré pour 1 interrupteur -Einbaubüchse für 1 Schalter -Recessed fitting box for 1 switch</p>	1	Stuk Pièce Stück Piece	ACDR633	<table border="1"> <tr><td>BR</td><td>X</td></tr> <tr><td>AN</td><td></td></tr> <tr><td>KL</td><td></td></tr> <tr><td>GS</td><td></td></tr> <tr><td>Z</td><td></td></tr> <tr><td>W</td><td></td></tr> </table>	BR	X	AN		KL		GS		Z		W	
BR	X															
AN																
KL																
GS																
Z																
W																
 <p><b>ACDR631A</b> -Opbouwdoos voor 2 schakelaars -Boîtier applicable pour 2 interrupteurs -Aufbaubüchse für 2 Schalter -Surface mounting box for 2 switches</p>	1	Stuk Pièce Stück Piece	ACDR633	<table border="1"> <tr><td>BR</td><td>X</td></tr> <tr><td>AN</td><td></td></tr> <tr><td>KL</td><td></td></tr> <tr><td>GS</td><td></td></tr> <tr><td>Z</td><td></td></tr> <tr><td>W</td><td></td></tr> </table>	BR	X	AN		KL		GS		Z		W	
BR	X															
AN																
KL																
GS																
Z																
W																
 <p><b>ACDR631B</b> -Inbouwdoos voor 2 schakelaars -Boîtier à encastré pour 2 interrupteurs -Einbaubüchse für 2 Schalter -Recessed fitting box for 2 switches</p>	1	Stuk Pièce Stück Piece	ACDR633	<table border="1"> <tr><td>BR</td><td>X</td></tr> <tr><td>AN</td><td></td></tr> <tr><td>KL</td><td></td></tr> <tr><td>GS</td><td></td></tr> <tr><td>Z</td><td></td></tr> <tr><td>W</td><td></td></tr> </table>	BR	X	AN		KL		GS		Z		W	
BR	X															
AN																
KL																
GS																
Z																
W																
 <p><b>ACDR632A</b> -Opbouwdoos voor 3 schakelaars -Boîtier applicable pour 3 interrupteurs -Aufbaubüchse für 3 Schalter -Surface mounting box for 3 switches</p>	1	Stuk Pièce Stück Piece	ACDR633	<table border="1"> <tr><td>BR</td><td>X</td></tr> <tr><td>AN</td><td></td></tr> <tr><td>KL</td><td></td></tr> <tr><td>GS</td><td></td></tr> <tr><td>Z</td><td></td></tr> <tr><td>W</td><td></td></tr> </table>	BR	X	AN		KL		GS		Z		W	
BR	X															
AN																
KL																
GS																
Z																
W																
 <p><b>ACDR632B</b> -Inbouwdoos voor 3 schakelaars -Boîtier à encastré pour 3 interrupteurs -Einbaubüchse für 3 Schalter -Recessed fitting box for 3 switches</p>	1	Stuk Pièce Stück Piece	ACDR633	<table border="1"> <tr><td>BR</td><td>X</td></tr> <tr><td>AN</td><td></td></tr> <tr><td>KL</td><td></td></tr> <tr><td>GS</td><td></td></tr> <tr><td>Z</td><td></td></tr> <tr><td>W</td><td></td></tr> </table>	BR	X	AN		KL		GS		Z		W	
BR	X															
AN																
KL																
GS																
Z																
W																

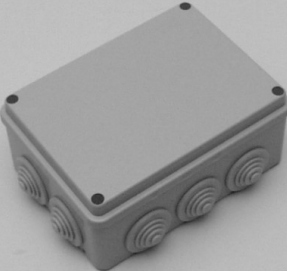
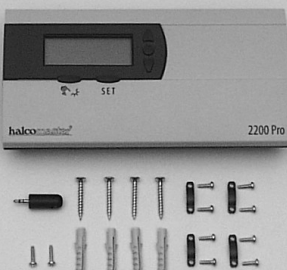
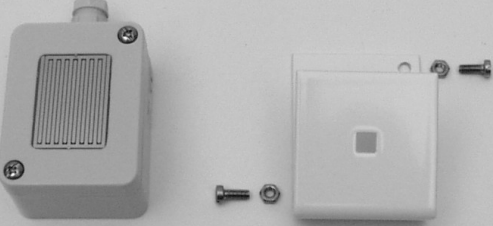

## TOEBEHOREN - ACCESSOIRES - ZUBEHÖRTEILE - ACCESSORIES

		Verp. per Emb. par Pack pr. Pack pr.	Eenheid Unité Einheit Unit	Toepassing Application Anwendung Application	Kleur Couleur Farbe Color												
	<b>ACDR633</b> -Dubbele schakelaar -Interrupteur double -Doppel Schalter -Double switch  MAX. 10A	1	Stuk Pièce Stück Pièce	ACDR615	<table border="1"> <tr><td>BR</td><td>X</td></tr> <tr><td>AN</td><td></td></tr> <tr><td>KL</td><td></td></tr> <tr><td>GS</td><td></td></tr> <tr><td>Z</td><td></td></tr> <tr><td>W</td><td></td></tr> </table>	BR	X	AN		KL		GS		Z		W	
BR	X																
AN																	
KL																	
GS																	
Z																	
W																	
	<b>ACDR660</b> -Zelfklevende alu-folie ( br.=100mm ) -Feuille autocollante ( larg.=100mm ) -Selbstklebend alu folie ( br.=100mm ) -Self adhesive alu foil ( width=100mm )	1	Stuk Pièce Stück Pièce		<table border="1"> <tr><td>BR</td><td>X</td></tr> <tr><td>AN</td><td></td></tr> <tr><td>KL</td><td></td></tr> <tr><td>GS</td><td></td></tr> <tr><td>Z</td><td></td></tr> <tr><td>W</td><td></td></tr> </table>	BR	X	AN		KL		GS		Z		W	
BR	X																
AN																	
KL																	
GS																	
Z																	
W																	
	<b>ACDR722</b> -Relaisdoos -Boîte de relais -Relaisbox -Relaisbox	1	Stuk Pièce Stück Pièce	ACDR615	<table border="1"> <tr><td>BR</td><td>X</td></tr> <tr><td>AN</td><td></td></tr> <tr><td>KL</td><td></td></tr> <tr><td>GS</td><td></td></tr> <tr><td>Z</td><td></td></tr> <tr><td>W</td><td></td></tr> </table>	BR	X	AN		KL		GS		Z		W	
BR	X																
AN																	
KL																	
GS																	
Z																	
W																	
	<b>ACDR725</b> -Automaat + binnenthermostaat -Automate + thermostate à l'intérieur -Automat + innen Thermostat -Control unit + inside thermostat	1	Stuk Pièce Stück Pièce	ACDR615	<table border="1"> <tr><td>BR</td><td>X</td></tr> <tr><td>AN</td><td></td></tr> <tr><td>KL</td><td></td></tr> <tr><td>GS</td><td></td></tr> <tr><td>Z</td><td></td></tr> <tr><td>W</td><td></td></tr> </table>	BR	X	AN		KL		GS		Z		W	
BR	X																
AN																	
KL																	
GS																	
Z																	
W																	
	<b>ACDR727</b> -Regenmelder -Avertisseur de pluie -Regen Alarmgeber -Rain detector	1	Stuk Pièce Stück Pièce	ACDR615	<table border="1"> <tr><td>BR</td><td>X</td></tr> <tr><td>AN</td><td></td></tr> <tr><td>KL</td><td></td></tr> <tr><td>GS</td><td></td></tr> <tr><td>Z</td><td></td></tr> <tr><td>W</td><td></td></tr> </table>	BR	X	AN		KL		GS		Z		W	
BR	X																
AN																	
KL																	
GS																	
Z																	
W																	

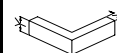

**TOEBEHOREN - ACCESSOIRES - ZUBEHÖRTEILE - ACCESSORIES**

		Verp. per Emb. par Pack pr.	Einheid Unité Einheit Unit	Toepassing Application Anwendung Application	Kleur Couleur Farbe Color												
	<p><b>ACDR728</b></p> <ul style="list-style-type: none"> <li>-Winddetector</li> <li>-Décteur de vent</li> <li>-Lüftentaster</li> <li>-Wind detector</li> </ul>	1	Stuk Pièce Stück Piece	ACDR615	<table border="1"> <tr><td>BR</td><td>X</td></tr> <tr><td>AN</td><td></td></tr> <tr><td>KL</td><td></td></tr> <tr><td>GS</td><td></td></tr> <tr><td>Z</td><td></td></tr> <tr><td>W</td><td></td></tr> </table>	BR	X	AN		KL		GS		Z		W	
BR	X																
AN																	
KL																	
GS																	
Z																	
W																	
	<p><b>ACDR750</b></p> <ul style="list-style-type: none"> <li>-Ontvanger</li> <li>-Récepteur</li> <li>-Empfänger</li> <li>-Receiver</li> </ul>	1	Stuk Pièce Stück Piece	ACDR615	<table border="1"> <tr><td>BR</td><td>X</td></tr> <tr><td>AN</td><td></td></tr> <tr><td>KL</td><td></td></tr> <tr><td>GS</td><td></td></tr> <tr><td>Z</td><td></td></tr> <tr><td>W</td><td></td></tr> </table>	BR	X	AN		KL		GS		Z		W	
BR	X																
AN																	
KL																	
GS																	
Z																	
W																	
	<p><b>ACDR751</b></p> <ul style="list-style-type: none"> <li>-Zender</li> <li>-Commande à distance</li> <li>-Sender</li> <li>-Remote control</li> </ul>	1	Stuk Pièce Stück Piece	ACDR615	<table border="1"> <tr><td>BR</td><td>X</td></tr> <tr><td>AN</td><td></td></tr> <tr><td>KL</td><td></td></tr> <tr><td>GS</td><td></td></tr> <tr><td>Z</td><td></td></tr> <tr><td>W</td><td></td></tr> </table>	BR	X	AN		KL		GS		Z		W	
BR	X																
AN																	
KL																	
GS																	
Z																	
W																	
	<p><b>ACDR910</b></p> <ul style="list-style-type: none"> <li>-Afstandhouder 20mm PVC</li> <li>-Entretoise 20mm PVC</li> <li>-Abstandstück 20mm PVC</li> <li>-Spacer 20mm PVC</li> </ul>	1	Stuk Pièce Stück Piece	DR910 DR065	<table border="1"> <tr><td>BR</td><td>X</td></tr> <tr><td>AN</td><td></td></tr> <tr><td>KL</td><td></td></tr> <tr><td>GS</td><td></td></tr> <tr><td>Z</td><td></td></tr> <tr><td>W</td><td></td></tr> </table>	BR	X	AN		KL		GS		Z		W	
BR	X																
AN																	
KL																	
GS																	
Z																	
W																	
	<p><b>ACDR920</b></p> <ul style="list-style-type: none"> <li>-Boormal voor DR020</li> <li>-Calibre pour DR020</li> <li>-Bohrschablone für DR020</li> <li>-Boring jig for DR020</li> </ul>	1	Stuk Pièce Stück Piece	DR020	<table border="1"> <tr><td>BR</td><td>X</td></tr> <tr><td>AN</td><td></td></tr> <tr><td>KL</td><td></td></tr> <tr><td>GS</td><td></td></tr> <tr><td>Z</td><td></td></tr> <tr><td>W</td><td></td></tr> </table>	BR	X	AN		KL		GS		Z		W	
BR	X																
AN																	
KL																	
GS																	
Z																	
W																	

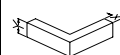

## TOEBEHOREN - ACCESSOIRES - ZUBEHÖRTEILE - ACCESSORIES

		Verp. per Emb. par Pack pr. Pack pr.	Eenheid Unité Einheit Unit	Toepassing Application Anwendung Application	Kleur Couleur Farbe Color												
	<b>ACDR921</b> -Boormal voor DR010-11-12 -Calibre pour DR010-11-12 -Bohrschablone für DR010-11-12 -Boring jig for DR010-11-12	1	Stuk Pièce Stück Piece	DR010 DR011 DR012	<table border="1"> <tr><td>BR</td><td>X</td></tr> <tr><td>AN</td><td></td></tr> <tr><td>KL</td><td></td></tr> <tr><td>GS</td><td></td></tr> <tr><td>Z</td><td></td></tr> <tr><td>W</td><td></td></tr> </table>	BR	X	AN		KL		GS		Z		W	
BR	X																
AN																	
KL																	
GS																	
Z																	
W																	
	<b>ACDV205</b> -Dichtingsborstel voor dubbel glas -Brosse d'étanchéité pour double vitrage -Dichtungsbürste für doppel Verglasung -Weatherstrip for double glazing	20	m	DR015	<table border="1"> <tr><td>BR</td><td>X</td></tr> <tr><td>AN</td><td></td></tr> <tr><td>KL</td><td></td></tr> <tr><td>GS</td><td></td></tr> <tr><td>Z</td><td></td></tr> <tr><td>W</td><td></td></tr> </table>	BR	X	AN		KL		GS		Z		W	
BR	X																
AN																	
KL																	
GS																	
Z																	
W																	
	<b>ACMC016</b> -Beglazingsrubber -Joint de vitrage -Glasdichtung -Glazing gasket	150	m	DR067	<table border="1"> <tr><td>BR</td><td></td></tr> <tr><td>AN</td><td></td></tr> <tr><td>KL</td><td></td></tr> <tr><td>GS</td><td></td></tr> <tr><td>Z</td><td>X</td></tr> <tr><td>W</td><td></td></tr> </table>	BR		AN		KL		GS		Z	X	W	
BR																	
AN																	
KL																	
GS																	
Z	X																
W																	
	<b>ACMX09700</b> -Alu-polish -Alu-polish -Alu-polish -Alu-polish	1	Stuk Pièce Stück Piece		<table border="1"> <tr><td>BR</td><td>X</td></tr> <tr><td>AN</td><td></td></tr> <tr><td>KL</td><td></td></tr> <tr><td>GS</td><td></td></tr> <tr><td>Z</td><td></td></tr> <tr><td>W</td><td></td></tr> </table>	BR	X	AN		KL		GS		Z		W	
BR	X																
AN																	
KL																	
GS																	
Z																	
W																	
	<b>ACMX09761</b> -Maxi-gloss -Maxi-gloss -Maxi-gloss -Maxi-gloss	1	Stuk Pièce Stück Piece		<table border="1"> <tr><td>BR</td><td>X</td></tr> <tr><td>AN</td><td></td></tr> <tr><td>KL</td><td></td></tr> <tr><td>GS</td><td></td></tr> <tr><td>Z</td><td></td></tr> <tr><td>W</td><td></td></tr> </table>	BR	X	AN		KL		GS		Z		W	
BR	X																
AN																	
KL																	
GS																	
Z																	
W																	

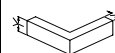

**TOEBEHOREN - ACCESSOIRES - ZUBEHÖRTEILE - ACCESSORIES**

	Verp. per Emb. par Pack pr.	Einheid Unit	Toepassing Application	Kleur Colour												
 <p><b>ACMX09762</b></p> <ul style="list-style-type: none"> <li>-Periodi-clean</li> <li>-Periodi-clean</li> <li>-Periodi-clean</li> <li>-Periodi-clean</li> </ul>	1	Stuk Pièce Stück Piece		<table border="1"> <tr><td>BR</td><td>X</td></tr> <tr><td>AN</td><td></td></tr> <tr><td>KL</td><td></td></tr> <tr><td>GS</td><td></td></tr> <tr><td>Z</td><td></td></tr> <tr><td>W</td><td></td></tr> </table>	BR	X	AN		KL		GS		Z		W	
BR	X															
AN																
KL																
GS																
Z																
W																
 <p><b>ACMX09763</b></p> <ul style="list-style-type: none"> <li>-Teflon spray</li> <li>-Teflon spray</li> <li>-Teflon spray</li> <li>-Teflon spray</li> </ul>	1	Stuk Pièce Stück Piece		<table border="1"> <tr><td>BR</td><td>X</td></tr> <tr><td>AN</td><td></td></tr> <tr><td>KL</td><td></td></tr> <tr><td>GS</td><td></td></tr> <tr><td>Z</td><td></td></tr> <tr><td>W</td><td></td></tr> </table>	BR	X	AN		KL		GS		Z		W	
BR	X															
AN																
KL																
GS																
Z																
W																
 <p><b>ACMX09764</b></p> <ul style="list-style-type: none"> <li>-Maxi-cleaner</li> <li>-Maxi-cleaner</li> <li>-Maxi-cleaner</li> <li>-Maxi-cleaner</li> </ul>	1	Stuk Pièce Stück Piece		<table border="1"> <tr><td>BR</td><td>X</td></tr> <tr><td>AN</td><td></td></tr> <tr><td>KL</td><td></td></tr> <tr><td>GS</td><td></td></tr> <tr><td>Z</td><td></td></tr> <tr><td>W</td><td></td></tr> </table>	BR	X	AN		KL		GS		Z		W	
BR	X															
AN																
KL																
GS																
Z																
W																
 <p><b>ACMX09770</b></p> <ul style="list-style-type: none"> <li>-Rol andywrap 100mm</li> <li>-Rouleau andywrap 100mm</li> <li>-Rolle andywrap 100mm</li> <li>-Roll andywrap 100mm</li> </ul>	150	m		<table border="1"> <tr><td>BR</td><td>X</td></tr> <tr><td>AN</td><td></td></tr> <tr><td>KL</td><td></td></tr> <tr><td>GS</td><td></td></tr> <tr><td>Z</td><td></td></tr> <tr><td>W</td><td></td></tr> </table>	BR	X	AN		KL		GS		Z		W	
BR	X															
AN																
KL																
GS																
Z																
W																
 <p><b>ACMX09775</b></p> <ul style="list-style-type: none"> <li>-Houder andywrap</li> <li>-Manche andywrap</li> <li>-Halter andywrap</li> <li>-Grip andywrap</li> </ul>	1	Stuk Pièce Stück Piece		<table border="1"> <tr><td>BR</td><td>X</td></tr> <tr><td>AN</td><td></td></tr> <tr><td>KL</td><td></td></tr> <tr><td>GS</td><td></td></tr> <tr><td>Z</td><td></td></tr> <tr><td>W</td><td></td></tr> </table>	BR	X	AN		KL		GS		Z		W	
BR	X															
AN																
KL																
GS																
Z																
W																





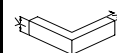

## TOEBEHOREN - ACCESSOIRES - ZUBEHÖRTEILE - ACCESSORIES

		Verp. per Emb. par Pack pr. Pack pr.	Eenheid Unité Einheit Unit	Toepassing Application Anwendung Application	Kleur Couleur Farbe Color												
	<b>ACMX09801</b> -Beschermtape 50mm(500m) -Tape de protection 50mm(500m) -Schutz Klebeband 50mm(500m) -Protective tape 50mm(500m)	1	Stuk Pièce Stück Pièce		<table border="1"> <tr><td>BR</td><td>X</td></tr> <tr><td>AN</td><td></td></tr> <tr><td>KL</td><td></td></tr> <tr><td>GS</td><td></td></tr> <tr><td>Z</td><td></td></tr> <tr><td>W</td><td></td></tr> </table>	BR	X	AN		KL		GS		Z		W	
BR	X																
AN																	
KL																	
GS																	
Z																	
W																	
	<b>ACMX09802</b> -Beschermtape 70mm(500m) -Tape de protection 70mm(500m) -Schutz Klebeband 70mm(500m) -Protective tape 70mm(500m)	1	Stuk Pièce Stück Pièce		<table border="1"> <tr><td>BR</td><td>X</td></tr> <tr><td>AN</td><td></td></tr> <tr><td>KL</td><td></td></tr> <tr><td>GS</td><td></td></tr> <tr><td>Z</td><td></td></tr> <tr><td>W</td><td></td></tr> </table>	BR	X	AN		KL		GS		Z		W	
BR	X																
AN																	
KL																	
GS																	
Z																	
W																	
	<b>ACMX09803</b> -Beschermtape 100mm(500m) -Tape de protection 100mm(500m) -Schutz Klebeband 100mm(500m) -Protective tape 100mm(500m)	1	Stuk Pièce Stück Pièce		<table border="1"> <tr><td>BR</td><td>X</td></tr> <tr><td>AN</td><td></td></tr> <tr><td>KL</td><td></td></tr> <tr><td>GS</td><td></td></tr> <tr><td>Z</td><td></td></tr> <tr><td>W</td><td></td></tr> </table>	BR	X	AN		KL		GS		Z		W	
BR	X																
AN																	
KL																	
GS																	
Z																	
W																	
	<b>ACUN020</b> -Klembaar verstekhoekje -Equerre avec fonction de serrage -Eckverbindung mit sperrfunktion -Alignement corner with locking function	10	Stuk Pièce Stück Pièce	DR010 DR011 DR012 DR020	<table border="1"> <tr><td>BR</td><td></td></tr> <tr><td>AN</td><td></td></tr> <tr><td>KL</td><td></td></tr> <tr><td>GS</td><td></td></tr> <tr><td>Z</td><td></td></tr> <tr><td>W</td><td></td></tr> </table>	BR		AN		KL		GS		Z		W	
BR																	
AN																	
KL																	
GS																	
Z																	
W																	
	<b>ACMX09830</b> -Kleefstof voor EPDM-rubbers -Colle pour EPDM-caoutchouc -Dichtmasse + Klebstoff EPDM-Gummi -Gum for EPDM-rubber	1	Stuk Pièce Stück Pièce		<table border="1"> <tr><td>BR</td><td>X</td></tr> <tr><td>AN</td><td></td></tr> <tr><td>KL</td><td></td></tr> <tr><td>GS</td><td></td></tr> <tr><td>Z</td><td></td></tr> <tr><td>W</td><td></td></tr> </table>	BR	X	AN		KL		GS		Z		W	
BR	X																
AN																	
KL																	
GS																	
Z																	
W																	







**TOEBEHOREN - ACCESSOIRES - ZUBEHÖRTEILE - ACCESSORIES**

		Verp. per Emb. par Pack pr. Pack pr.	Einheid Unité Einheit Unit	Toepassing Application Anwendung Application	Kleur Couleur Farbe Color												
	<b>ACVG31</b> -Beglazingsrubber binnen -Joint de vitrage intérieur -Glasanlage Dichtung -Glazing gasket inside	200	m	DR020	<table border="1"> <tr><td>BR</td><td></td></tr> <tr><td>AN</td><td></td></tr> <tr><td>KL</td><td></td></tr> <tr><td>GS</td><td></td></tr> <tr><td>Z</td><td>X</td></tr> <tr><td>W</td><td></td></tr> </table>	BR		AN		KL		GS		Z	X	W	
BR																	
AN																	
KL																	
GS																	
Z	X																
W																	
	<b>ACVG31N</b> -Beglazingsrubber binnen ronddraaiend -Joint de vitrage intérieur tournant -Glasanlage Dichtung herumdrehend -Glazing gasket inside rotated	100	m	DR020	<table border="1"> <tr><td>BR</td><td></td></tr> <tr><td>AN</td><td></td></tr> <tr><td>KL</td><td></td></tr> <tr><td>GS</td><td></td></tr> <tr><td>Z</td><td>X</td></tr> <tr><td>W</td><td></td></tr> </table>	BR		AN		KL		GS		Z	X	W	
BR																	
AN																	
KL																	
GS																	
Z	X																
W																	
	<b>ACVG32</b> -Beglazingsrubber 3mm -Joint de vitrage 3mm -Glasdichtung 3mm -Glazing gasket 3mm	100	m	DR060 DR061 DR062	<table border="1"> <tr><td>BR</td><td></td></tr> <tr><td>AN</td><td></td></tr> <tr><td>KL</td><td></td></tr> <tr><td>GS</td><td></td></tr> <tr><td>Z</td><td>X</td></tr> <tr><td>W</td><td></td></tr> </table>	BR		AN		KL		GS		Z	X	W	
BR																	
AN																	
KL																	
GS																	
Z	X																
W																	
	<b>ACVG32N</b> -Beglazingsrubber 3mm ronddraaiend -Joint de vitrage 3mm tournant -Glasdichtung 3mm herumdrehend -Glazing gasket 3mm rotated	100	m	DR060 DR061 DR062	<table border="1"> <tr><td>BR</td><td></td></tr> <tr><td>AN</td><td></td></tr> <tr><td>KL</td><td></td></tr> <tr><td>GS</td><td></td></tr> <tr><td>Z</td><td>X</td></tr> <tr><td>W</td><td></td></tr> </table>	BR		AN		KL		GS		Z	X	W	
BR																	
AN																	
KL																	
GS																	
Z	X																
W																	
	<b>ACVG33</b> -Beglazingsrubber 4mm -Joint de vitrage 4mm -Glasdichtung 4mm -Glazing gasket 4mm	100	m	DR060 DR061 DR062	<table border="1"> <tr><td>BR</td><td></td></tr> <tr><td>AN</td><td></td></tr> <tr><td>KL</td><td></td></tr> <tr><td>GS</td><td></td></tr> <tr><td>Z</td><td>X</td></tr> <tr><td>W</td><td></td></tr> </table>	BR		AN		KL		GS		Z	X	W	
BR																	
AN																	
KL																	
GS																	
Z	X																
W																	



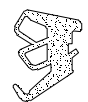

## TOEBEHOREN - ACCESSOIRES - ZUBEHÖRTEILE - ACCESSORIES

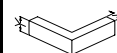
		Verp. per Emb. par Pack pr. Pack pr.	Eenheid Unité Einheit Unit	Toepassing Application Anwendung Application	Kleur Couleur Farbe Color												
	<b>ACVG33N</b> -Beglazingsrubber 4mm ronddraaiend -Joint de vitrage 4mm tournant -Glasdichtung 4mm herumdrehend -Glazing gasket 4mm rotated	100	m	DR060 DR061 DR062	<table border="1"> <tr><td>BR</td><td></td></tr> <tr><td>AN</td><td></td></tr> <tr><td>KL</td><td></td></tr> <tr><td>GS</td><td></td></tr> <tr><td>Z</td><td>X</td></tr> <tr><td>W</td><td></td></tr> </table>	BR		AN		KL		GS		Z	X	W	
BR																	
AN																	
KL																	
GS																	
Z	X																
W																	
	<b>ACVG34</b> -Beglazingsrubber 5mm -Joint de vitrage 5mm -Glasdichtung 5mm -Glazing gasket 5mm	200	m	DR060 DR061 DR062	<table border="1"> <tr><td>BR</td><td></td></tr> <tr><td>AN</td><td></td></tr> <tr><td>KL</td><td></td></tr> <tr><td>GS</td><td></td></tr> <tr><td>Z</td><td>X</td></tr> <tr><td>W</td><td></td></tr> </table>	BR		AN		KL		GS		Z	X	W	
BR																	
AN																	
KL																	
GS																	
Z	X																
W																	
	<b>ACVG34N</b> -Beglazingsrubber 5mm ronddraaiend -Joint de vitrage 5mm tournant -Glasdichtung 5mm herumdrehend -Glazing gasket 5mm rotated	100	m	DR060 DR061 DR062	<table border="1"> <tr><td>BR</td><td></td></tr> <tr><td>AN</td><td></td></tr> <tr><td>KL</td><td></td></tr> <tr><td>GS</td><td></td></tr> <tr><td>Z</td><td>X</td></tr> <tr><td>W</td><td></td></tr> </table>	BR		AN		KL		GS		Z	X	W	
BR																	
AN																	
KL																	
GS																	
Z	X																
W																	
	<b>ACVG340</b> -Beglazingsrubber 6mm -Joint de vitrage 6mm -Glasdichtung 6mm -Glazing gasket 6mm	200	m	DR060 DR061 DR062	<table border="1"> <tr><td>BR</td><td></td></tr> <tr><td>AN</td><td></td></tr> <tr><td>KL</td><td></td></tr> <tr><td>GS</td><td></td></tr> <tr><td>Z</td><td>X</td></tr> <tr><td>W</td><td></td></tr> </table>	BR		AN		KL		GS		Z	X	W	
BR																	
AN																	
KL																	
GS																	
Z	X																
W																	
	<b>ACVG340N</b> -Beglazingsrubber 6mm ronddraaiend -Joint de vitrage 6mm tournant -Glasdichtung 6mm herumdrehend -Glazing gasket 6mm rotated	100	m	DR060 DR061 DR062	<table border="1"> <tr><td>BR</td><td></td></tr> <tr><td>AN</td><td></td></tr> <tr><td>KL</td><td></td></tr> <tr><td>GS</td><td></td></tr> <tr><td>Z</td><td>X</td></tr> <tr><td>W</td><td></td></tr> </table>	BR		AN		KL		GS		Z	X	W	
BR																	
AN																	
KL																	
GS																	
Z	X																
W																	

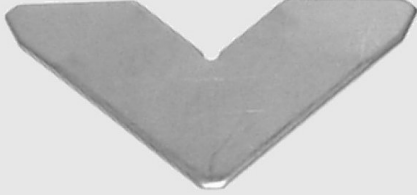

**TOEBEHOREN - ACCESSOIRES - ZUBEHORTEILE - ACCESSORIES**

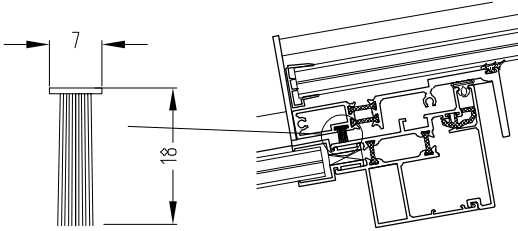
	Verp. per Emb. par Pack pr.	Einheid Unit	Toepassing Application	Kleur Couleur												
 <p><b>ACVL020</b> -Inox verstekhoekje -Equerre de jonction en inox -Inox Eckverstärkung -Stainless steel framing square</p>	1	Stuk Pièce Stück Piece	DR010 DR011 DR012 DR020	<table border="1"> <tr><td>BR</td><td>X</td></tr> <tr><td>AN</td><td></td></tr> <tr><td>KL</td><td></td></tr> <tr><td>GS</td><td></td></tr> <tr><td>Z</td><td></td></tr> <tr><td>W</td><td></td></tr> </table>	BR	X	AN		KL		GS		Z		W	
BR	X															
AN																
KL																
GS																
Z																
W																
 <p><b>ACVL020B</b> -Verstekhoekje in kunststof -Equerre de jonction en plastique -Eckverstärkung in plastik -Framing square in plastic</p>	1	Stuk Pièce Stück Piece	DR010 DR011 DR012 DR020	<table border="1"> <tr><td>BR</td><td></td></tr> <tr><td>AN</td><td></td></tr> <tr><td>KL</td><td></td></tr> <tr><td>GS</td><td></td></tr> <tr><td>Z</td><td>X</td></tr> <tr><td>W</td><td></td></tr> </table>	BR		AN		KL		GS		Z	X	W	
BR																
AN																
KL																
GS																
Z	X															
W																
 <p><b>ACVS012-18</b> -Dichtingsborstel voor polycarbonaat -Brosse d'étanchéité pour polycarbonate -Dichtingsbürste für Polycarbonat -Weatherstrip for polycarbonat</p>	25	m	DR015	<table border="1"> <tr><td>BR</td><td>X</td></tr> <tr><td>AN</td><td></td></tr> <tr><td>KL</td><td></td></tr> <tr><td>GS</td><td></td></tr> <tr><td>Z</td><td></td></tr> <tr><td>W</td><td></td></tr> </table>	BR	X	AN		KL		GS		Z		W	
BR	X															
AN																
KL																
GS																
Z																
W																

BR = BRUT - BRUT - ROH - BRUT  
 AN = ANODISATIE - ANODISE - ELOXIERT - ANODISED  
 KL = STANDAARDKLEUREN - COULEUR STANDARD - BASIS FARBEN - BASIC COLORS  
 GS = GEMOFFELD SPECIAAL - LAQUE SPECIAL - SPECIALFARBE - SPECIAL COLOR  
 Z = ZWART - NOIR - SCHWARZ - BLACK  
 W = WIT - BLANC - WEISS - WHITE



GEREEDSCHAP - OUTILLAGE  
WERKZEUG - TOOL



BEVESTIGING - FIXATION  
BEFESTIGUNG - FIXATION





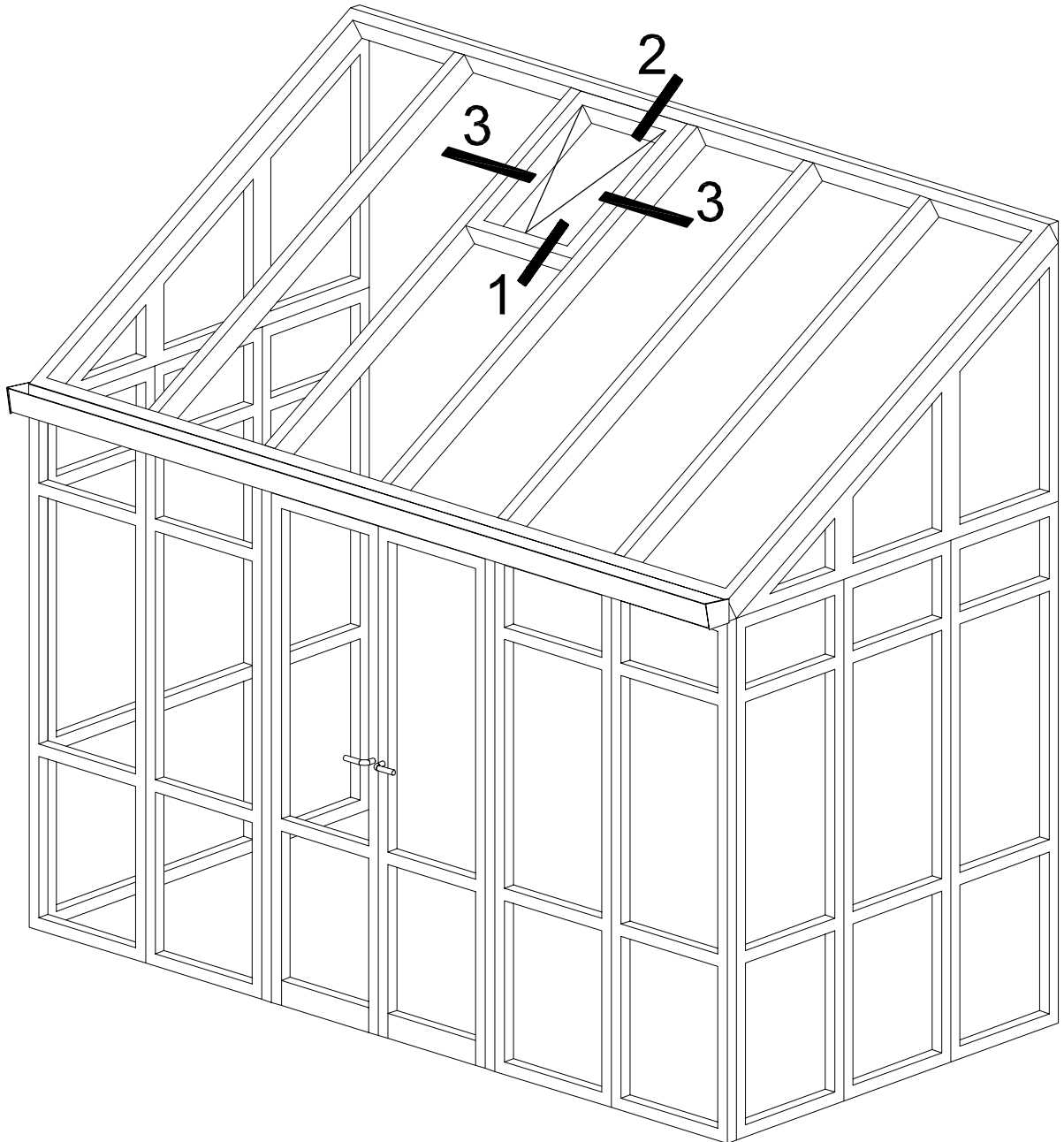

doortyp

## 1A

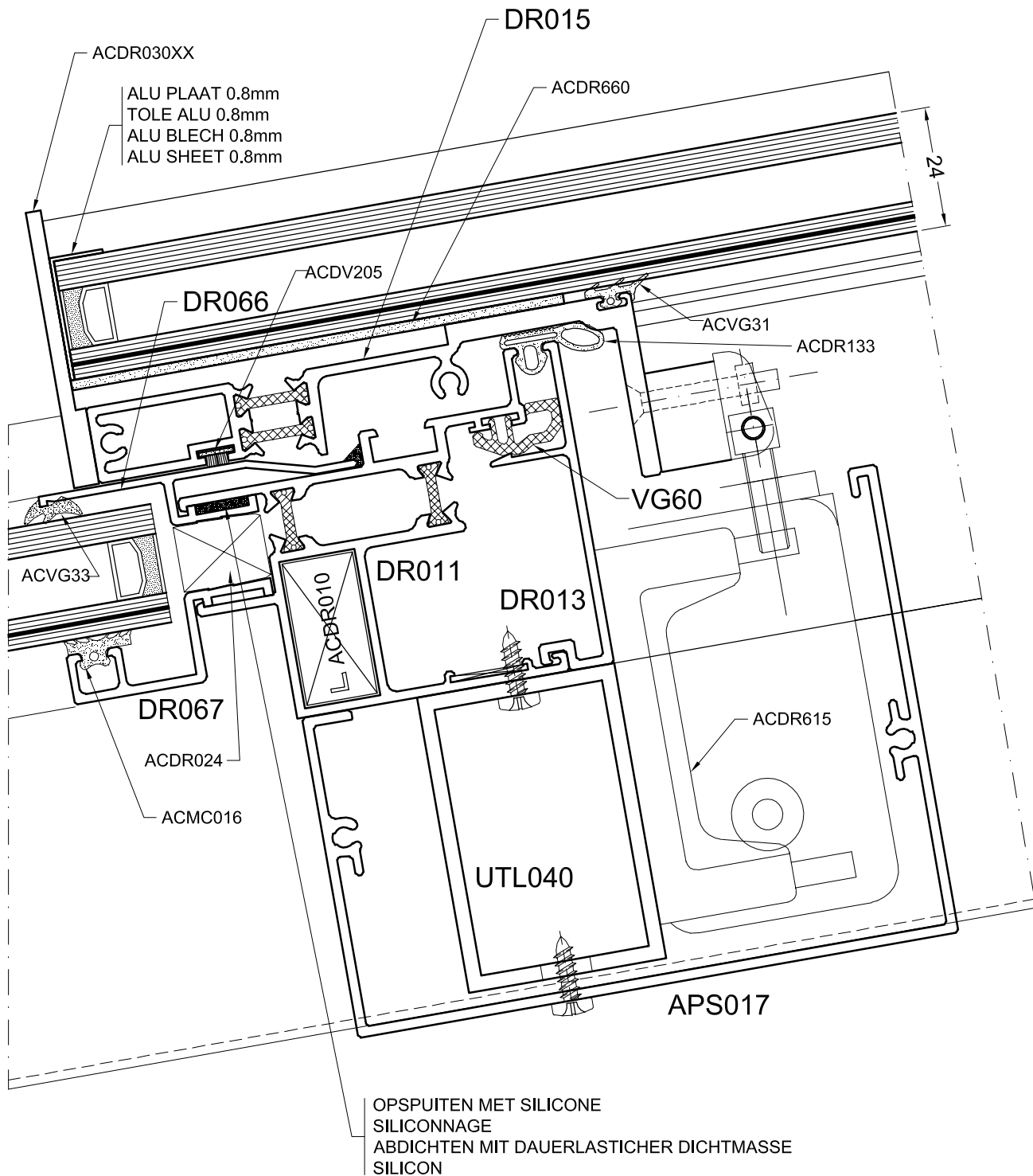

## 1B

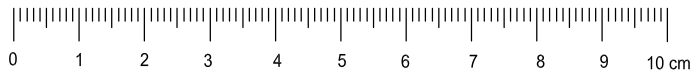
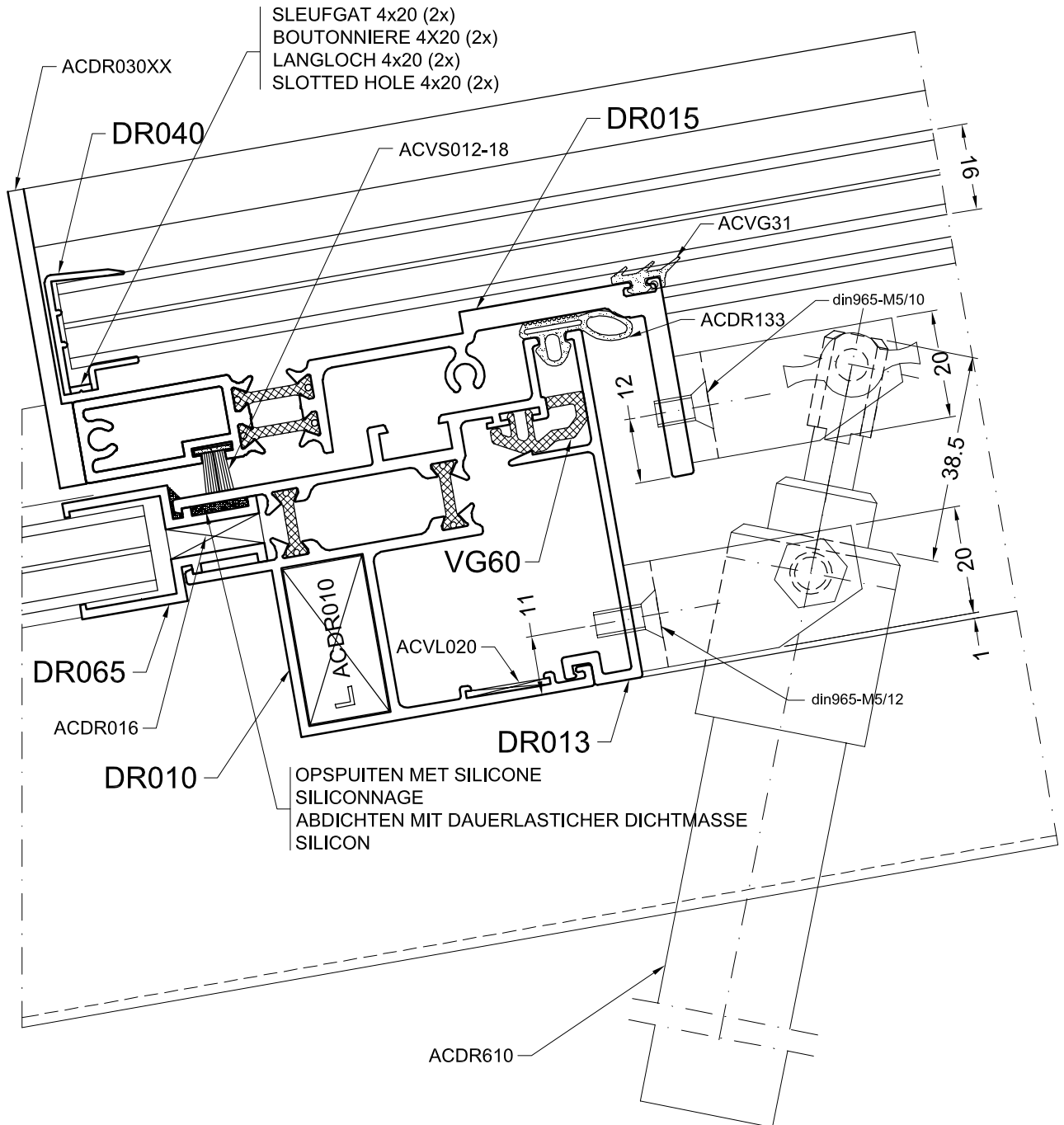

door1b

## 1C

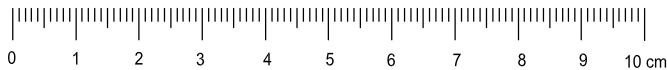
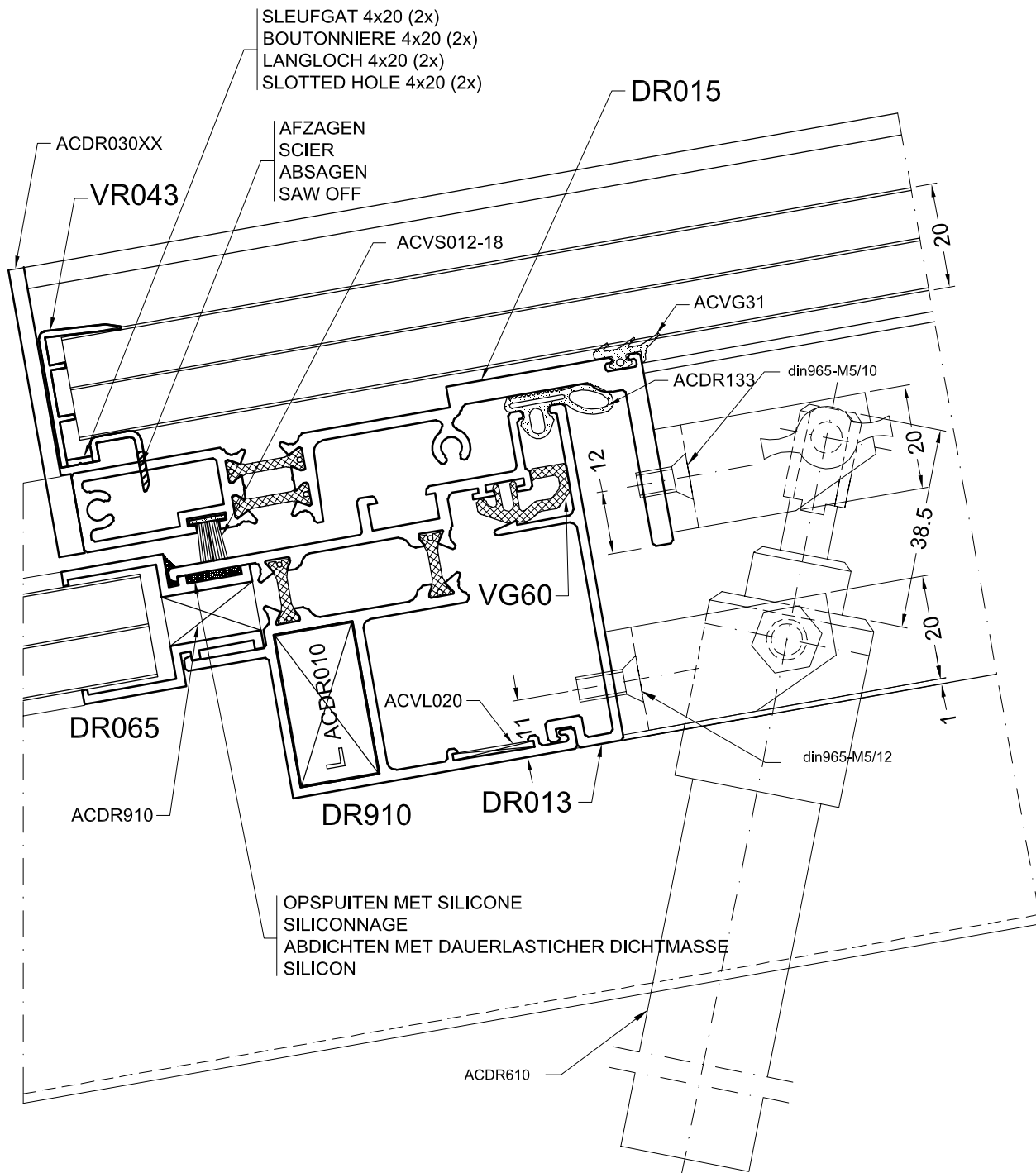

DOOR1C

## 1D

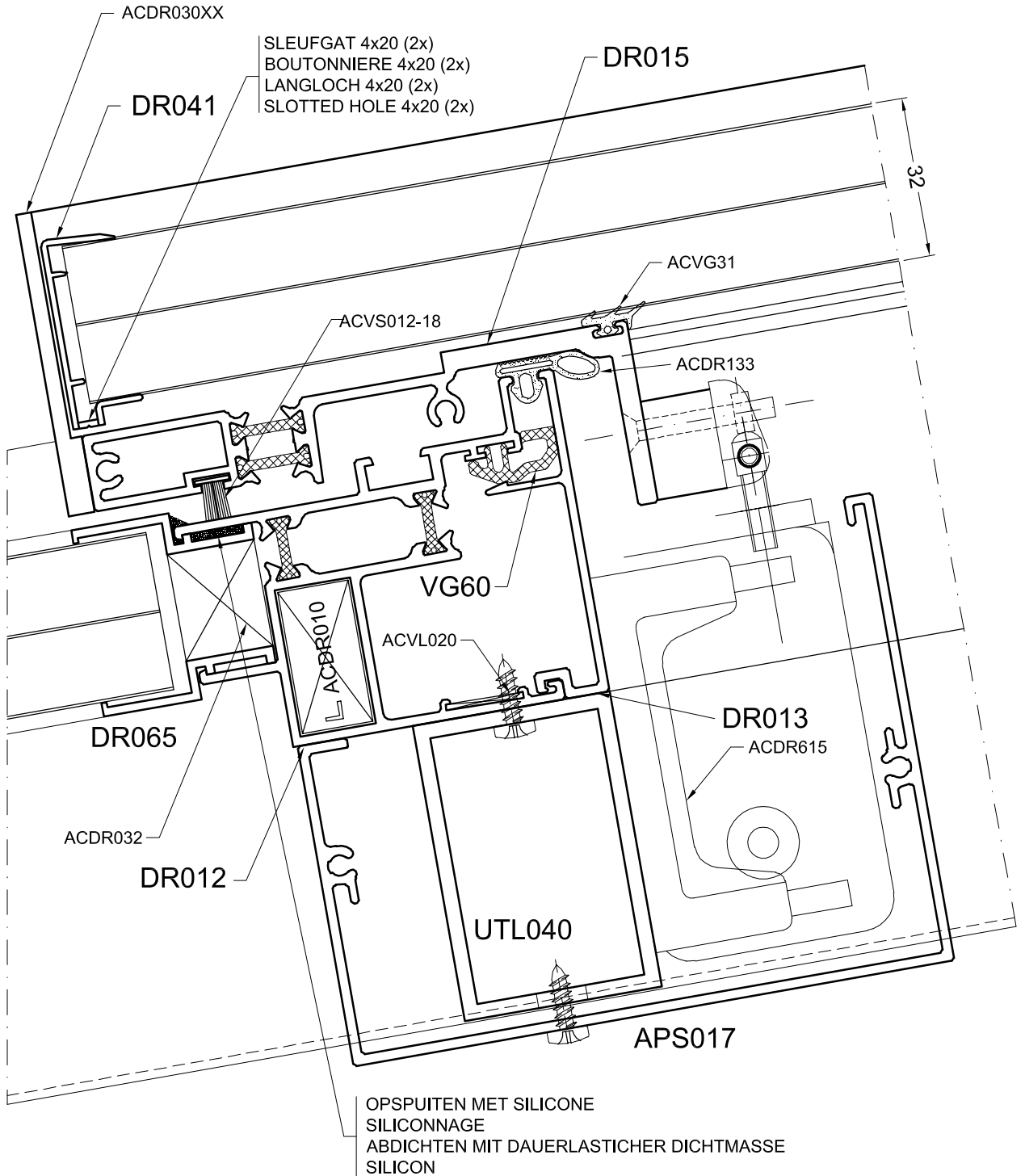

## 2A

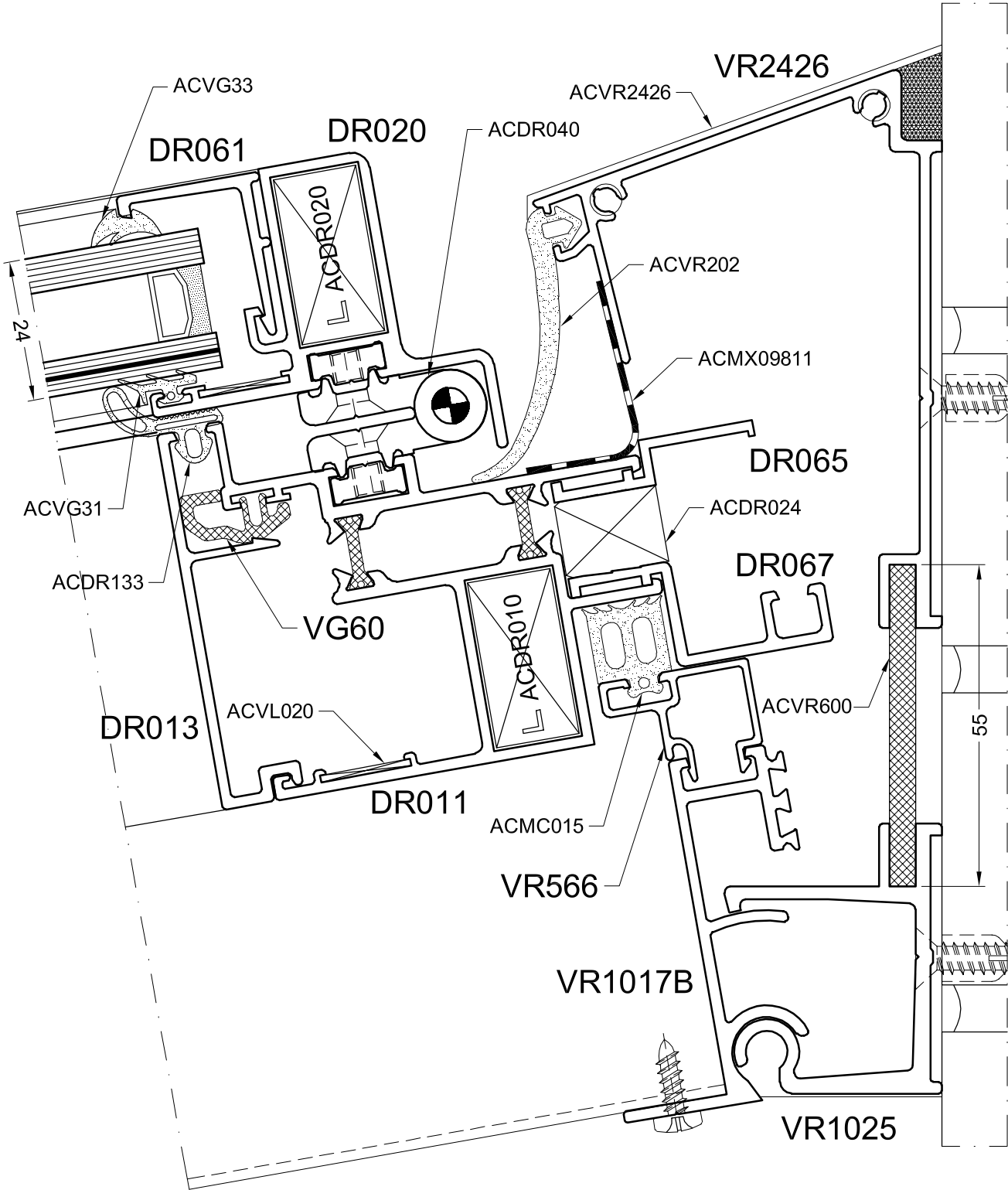

door2a

2B

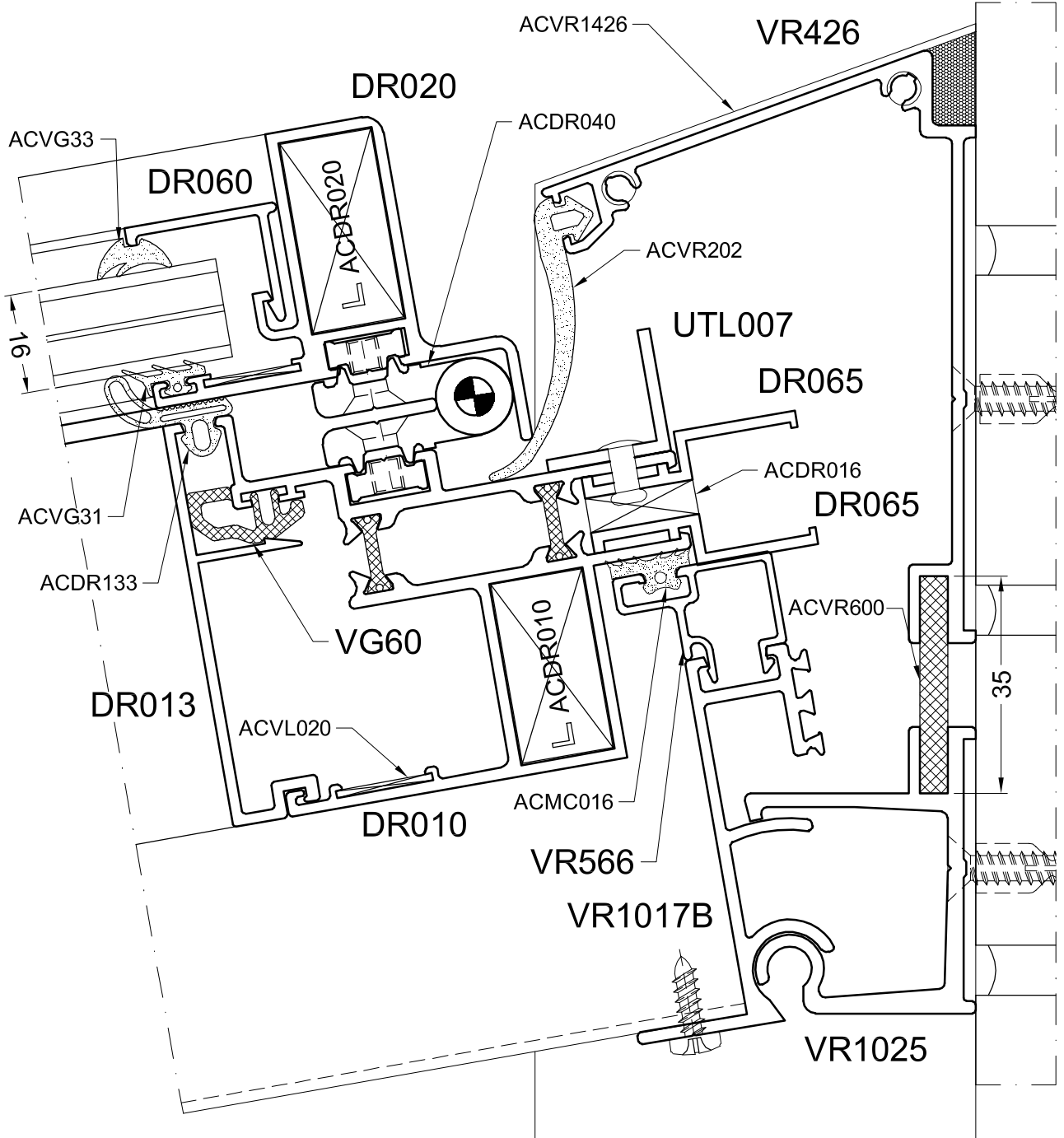

door2b



## 2D

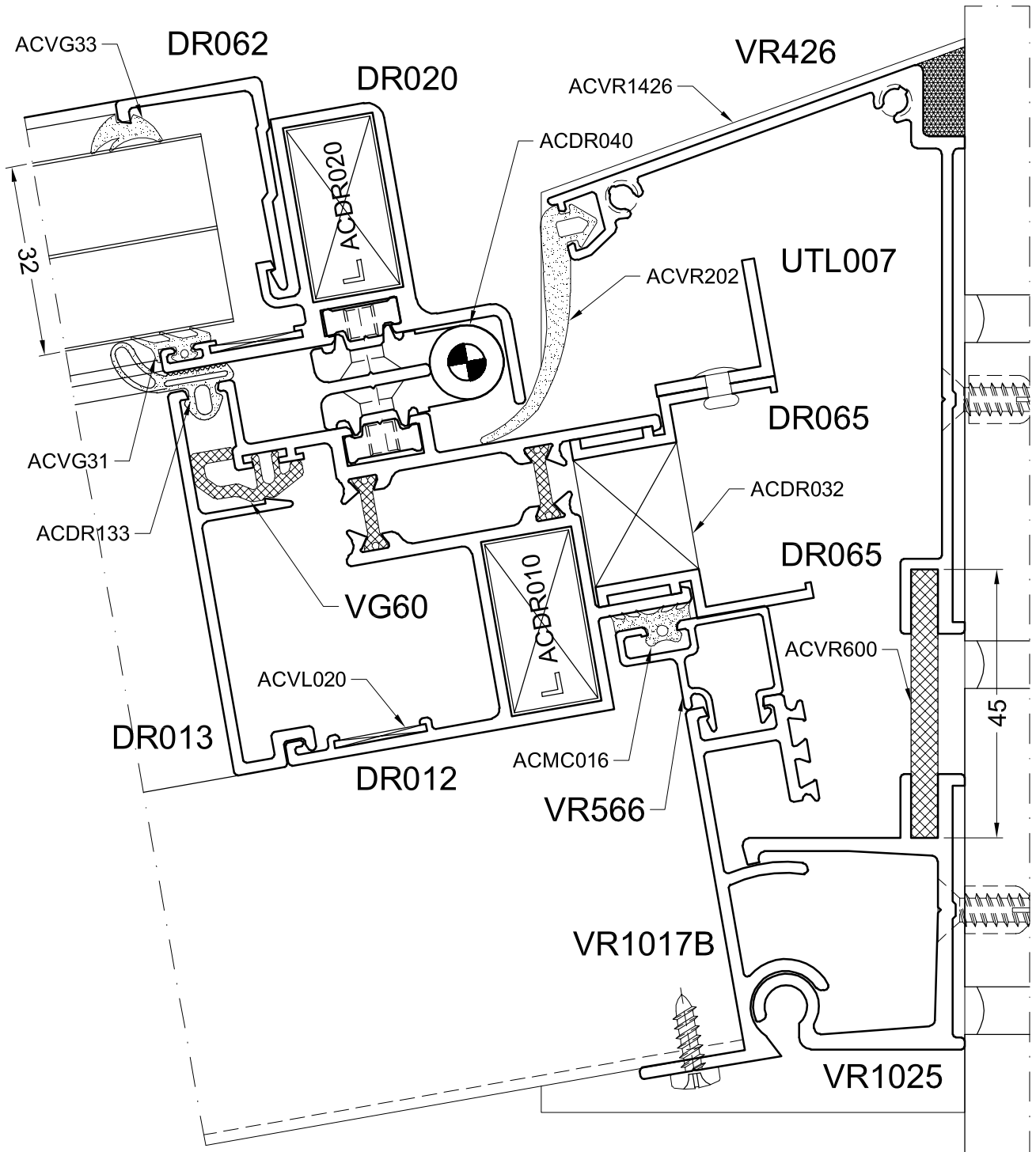

door2d

## 3A

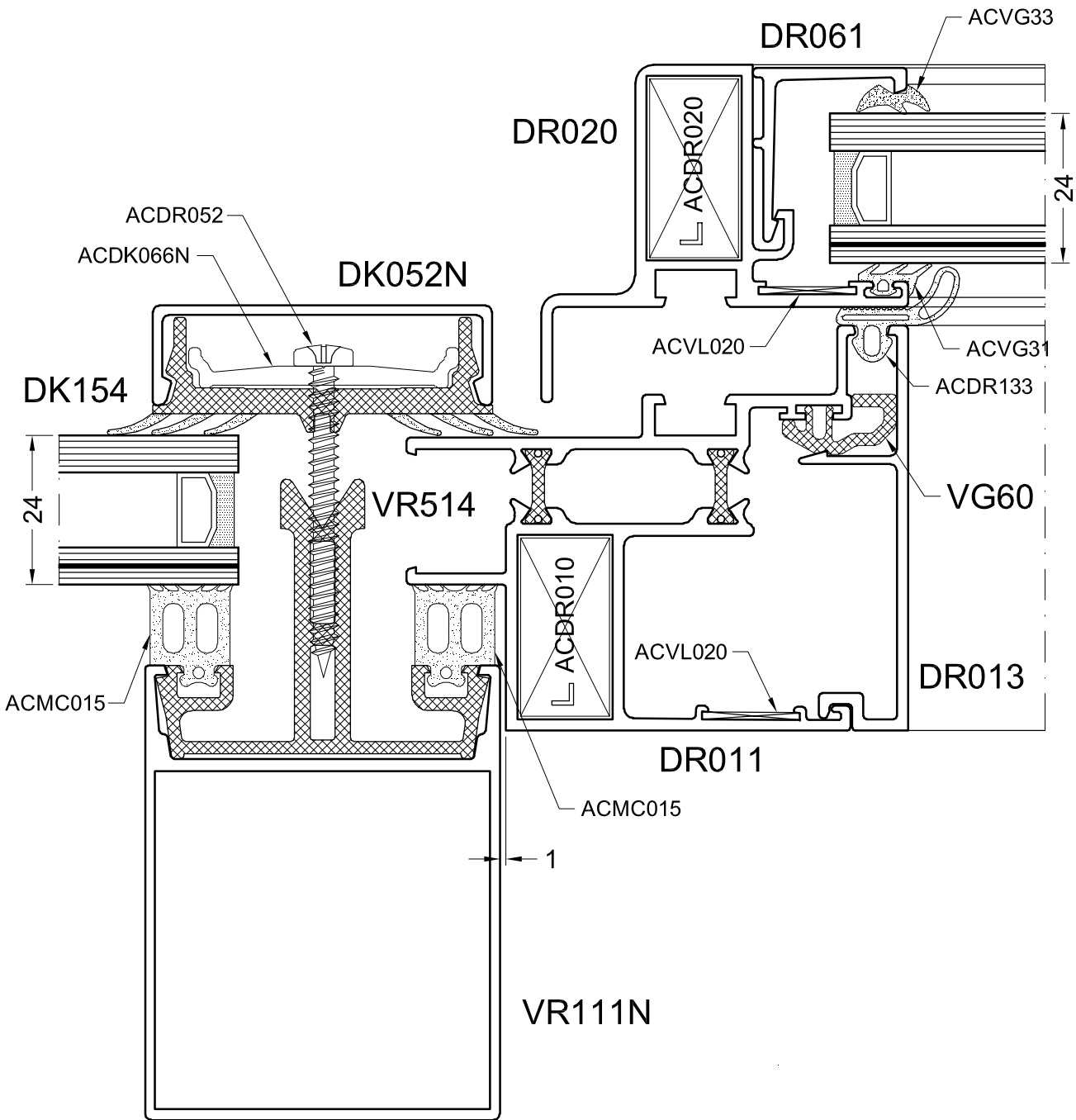

door3a

3B

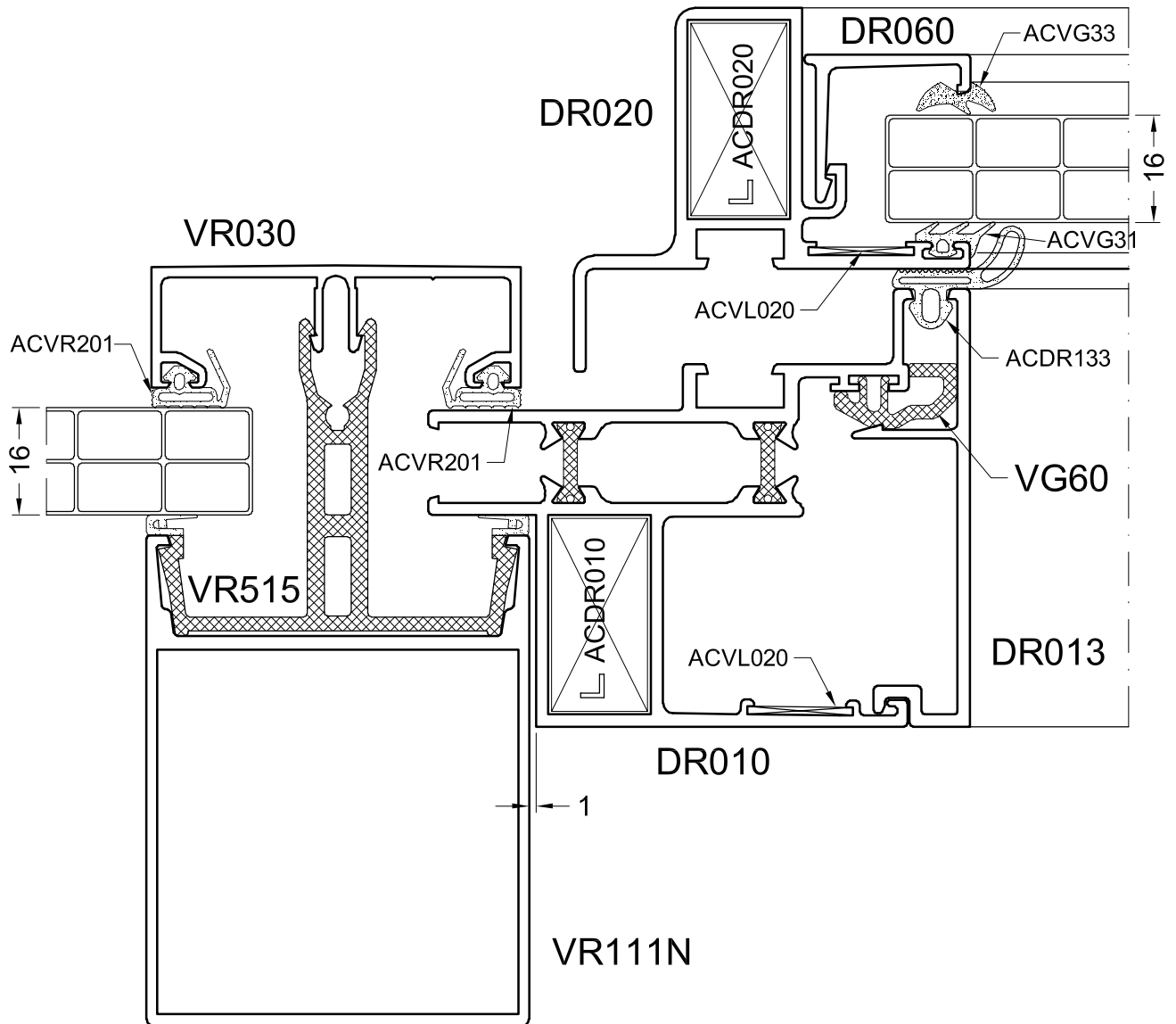

door3b

## 3C

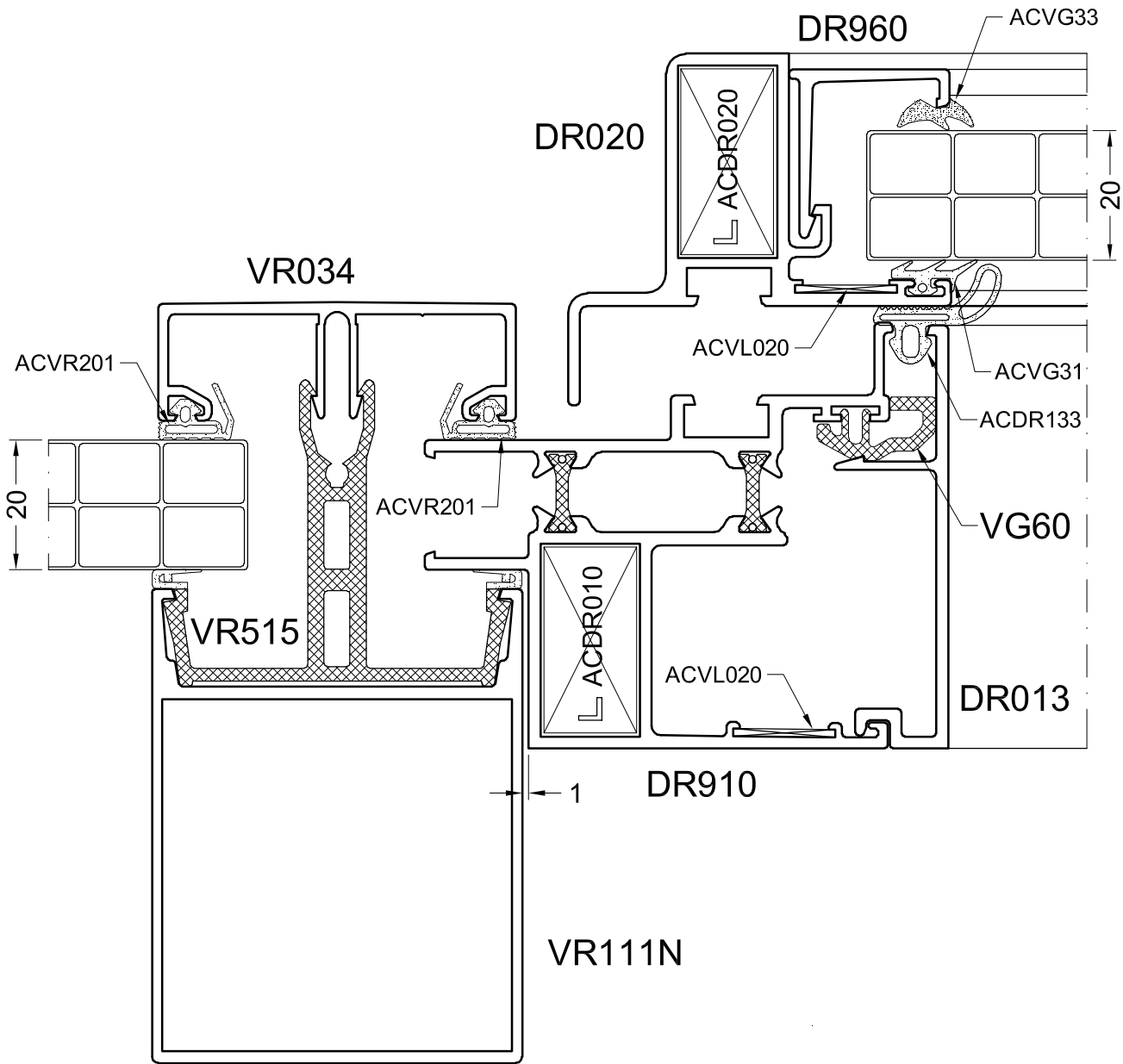

door3c

## 3D

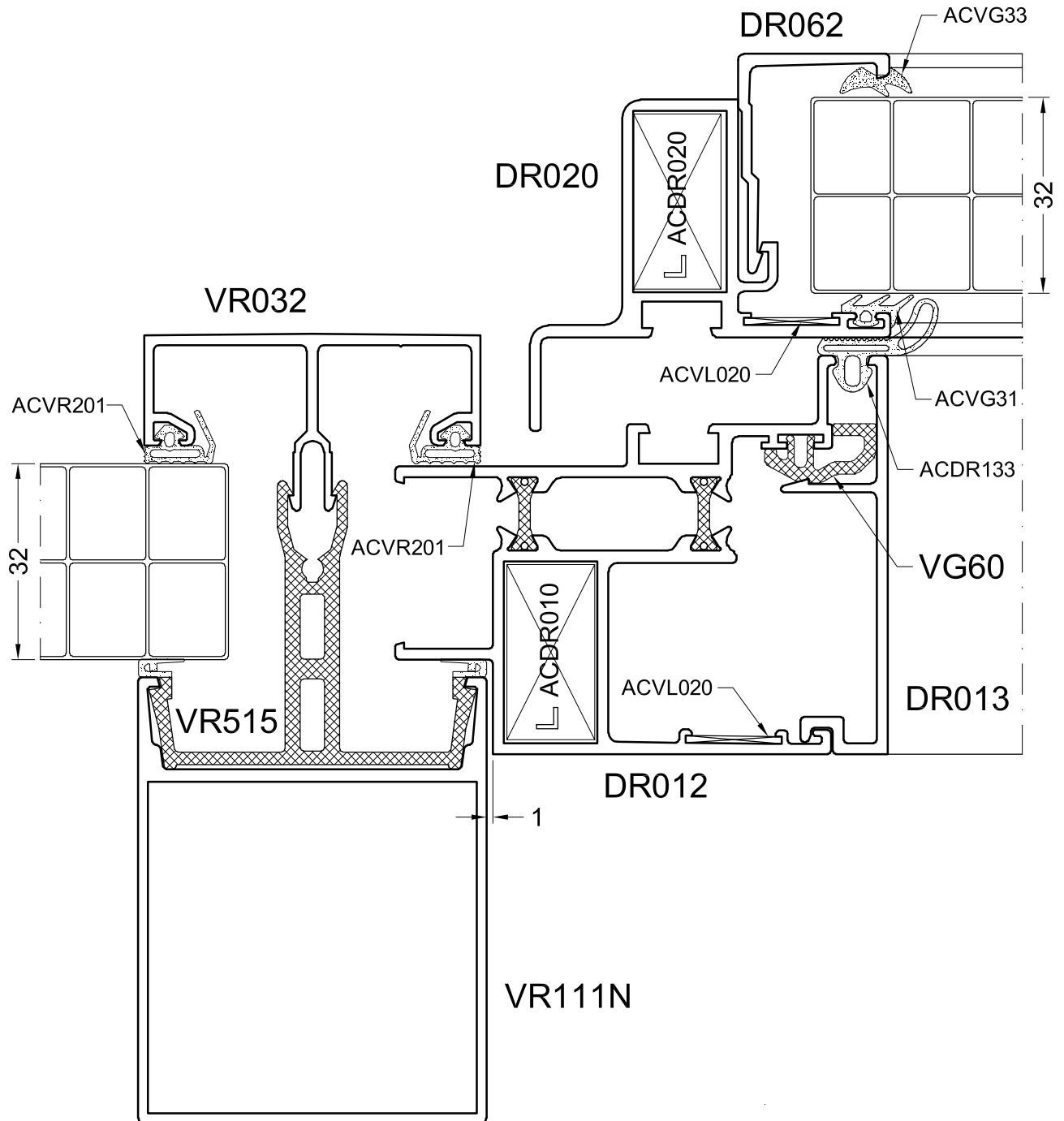

door3d



AUTOMAAT ZONDER AFSTANDSBESTURING  
 AUTOMATE SANS COMMANDE A DISTANCE  
 AUTOMAT OHNE FERNBEDIENUNG  
 CONTROL UNIT WITHOUT REMOTE CONTROL

ACDR615 (ELEKTRISCHE MOTOR MANUELE BED. 36KG -220V)  
 ACDR615 (MOTEUR ELECTRIQUE MANUEL. 36KG -220V)  
 ACDR615 (ELEKTRISCHEN MOTOR MANUELL 36KG -220V)  
 ACDR615 (ELECTRIC MOTOR MANUAL 36KG -220V)

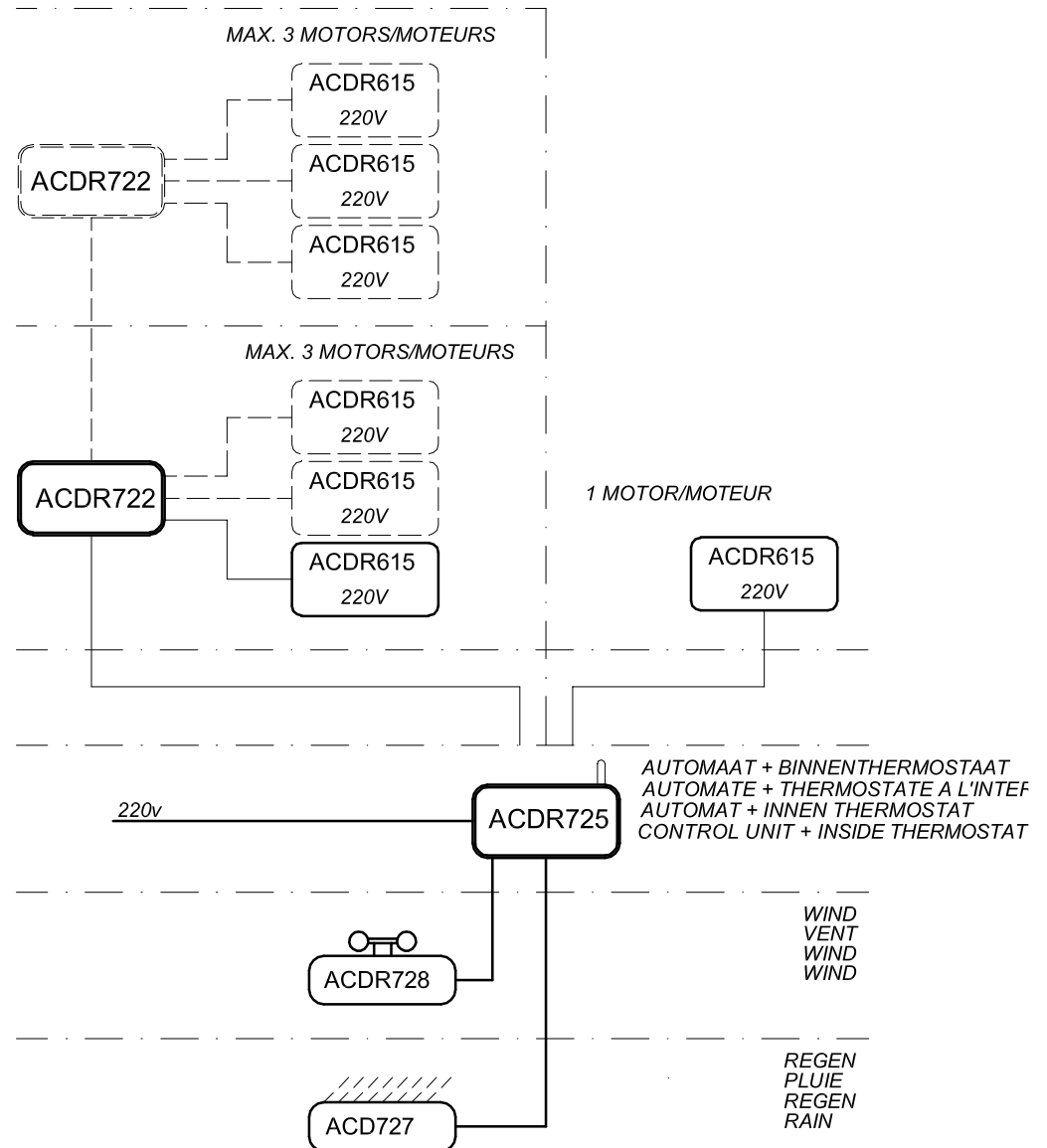

Info01

**AUTOMAAT MET AFSTANDBESTURING**  
**AUTOMATE AVEC COMMANDE A DISTANCE**  
**AUTOMAT MIT FERNBEDIENUNG**  
**CONTROL UNIT WITH REMOTE CONTROL**

ACDR615 (ELEKTRISCHE MOTOR MANUELE BED. 36KG -220V)

ACDR615 (ELEKTRISCHE MOTOR MANUELE BED. 36KG -220V)

ACDR615 (MOTEUR ELECTRIQUE MANUEL. 36KG -220V)

ACDR615 (ELEKTRISCHEN MOTOR MANUELL 36KG -220V)

ACDR615 (ELECTRIC MOTOR MANUAL 36KG -220V)

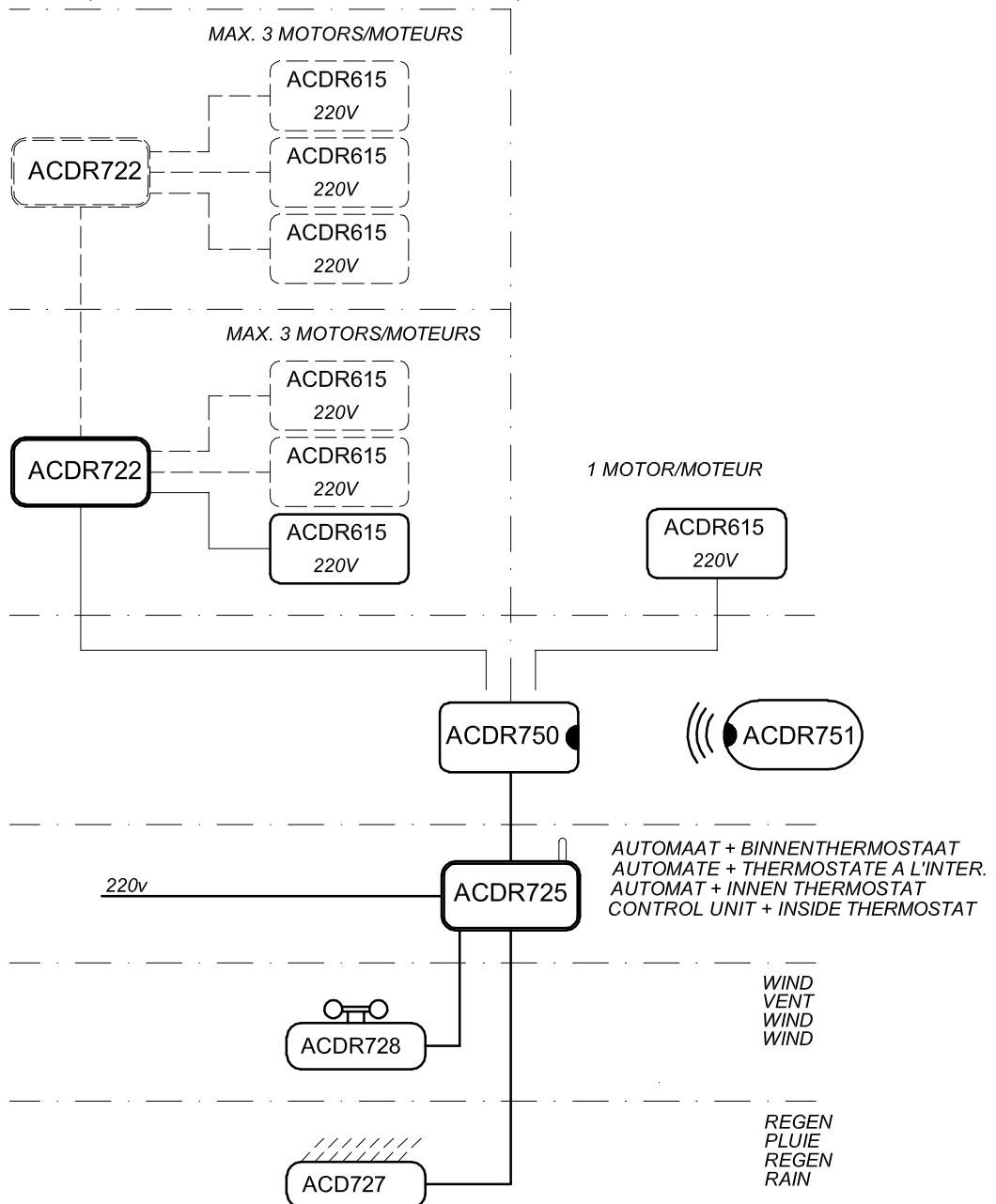

Info02





ZAAGTABELLEN - TABLES DE SCIAGES - ZUSCHNITT-TABELLEN - SAWING TABLES

ZAAGTABEL VOOR POLYCARBONAAT VAN 20mm  
LISTE DE DEBITS POUR POLYCARBONATE DE 20mm  
ZUSCHNITT-TABELLE FÜR POLYCARBONAT VON 20mm  
SAWING TABLE FOR POLYCARBONATE FROM 20mm

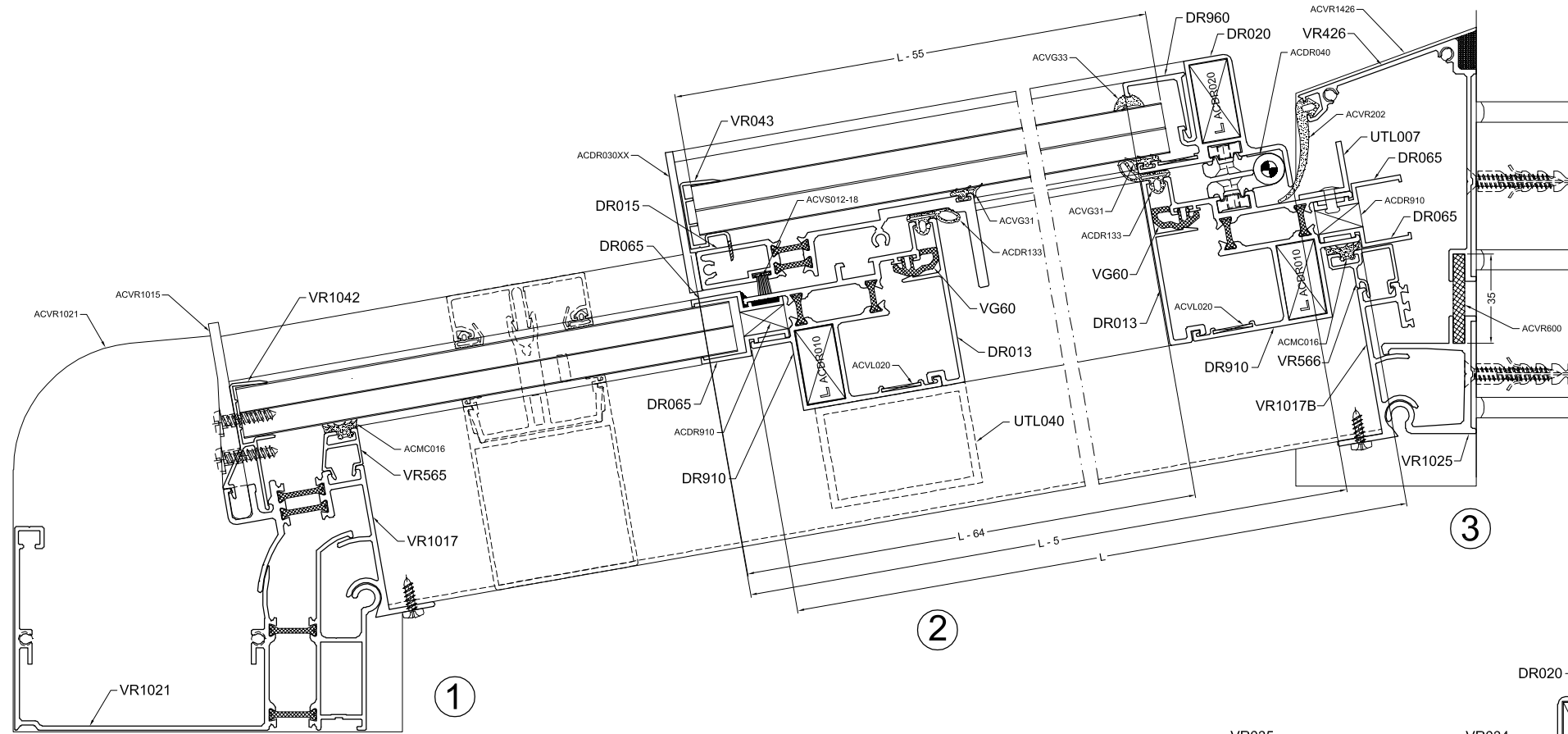

PROFIELEN PROFILES PROFILE PROFILS

DR910+13+VG60		2		A + 30
DR910+13+VG60		2		L
DR020		1		L - 5
DR020		1		L - 5
DR020		1		A - 15
DR015		1		A - 25
DR960		1		A - 82
DR960		2		L - 65
DR065		4		A + 30
VR043		1		A - 107
UTL007		1		A+30
UTL040		1		A

TOEBEHOREN ACCESSOIRES ZUBEHORTEILE ACCESSORIES

ACDR010	4
ACDR020	2
ACVL020	6
ACDR030XX	1 PAAR
ACDR040	2 OF/OU 3
ACVG31	2L+2A-400
ACVG33	2L+A-200
ACDR133	2L+2A-200
ACVS012-18	A-66
ACDR910	8

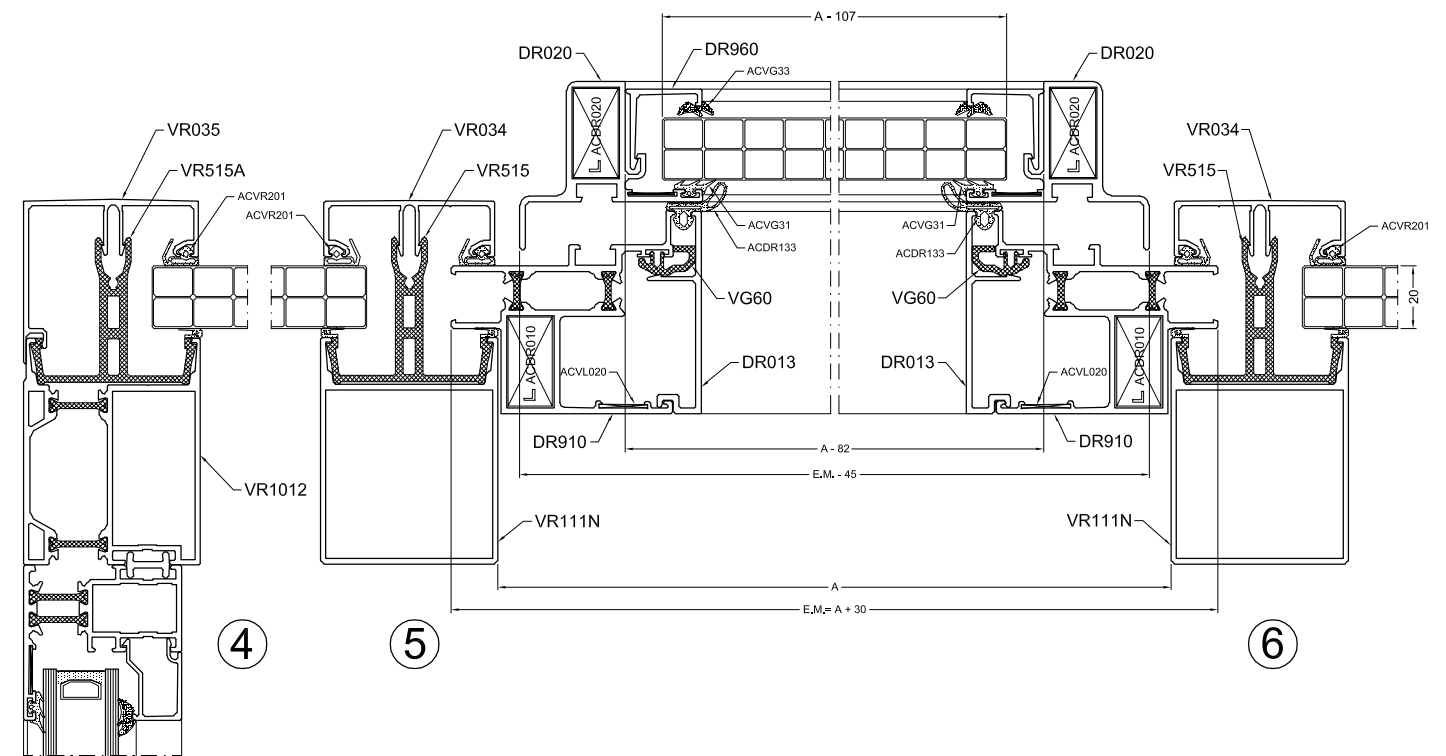
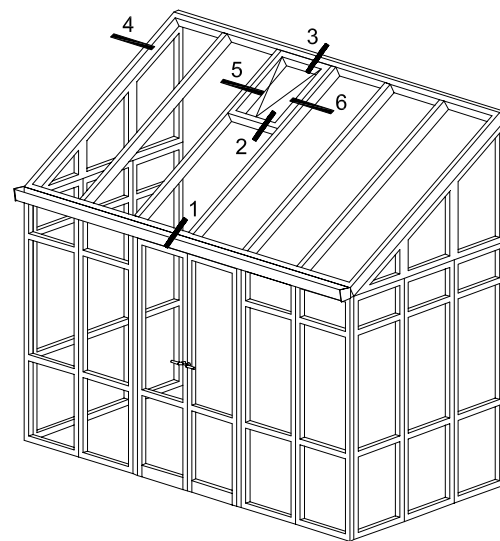

zaag02

ZAAGTABELLEN - TABLES DE SCIAGES - ZUSCHNITT-TABELLEN - SAWING TABLES

ZAAGTABEL VOOR POLYCARBONAAT VAN 32mm  
 LISTE DE DEBITS POUR POLYCARBONATE DE 32mm  
 ZUSCHNITT-TABELLE FÜR POLYCARBONAT VON 32mm  
 SAWING TABLE FOR POLYCARBONATE FROM 32mm

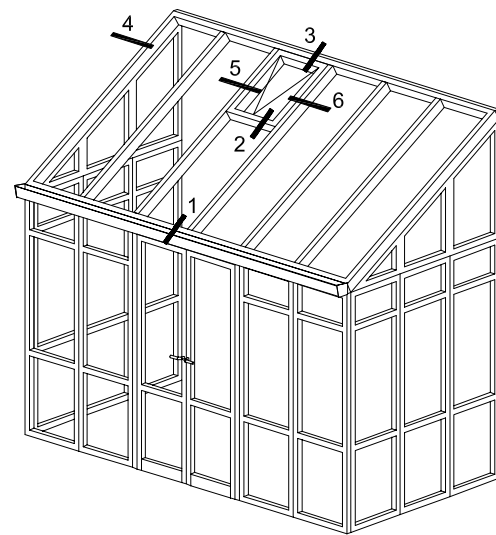
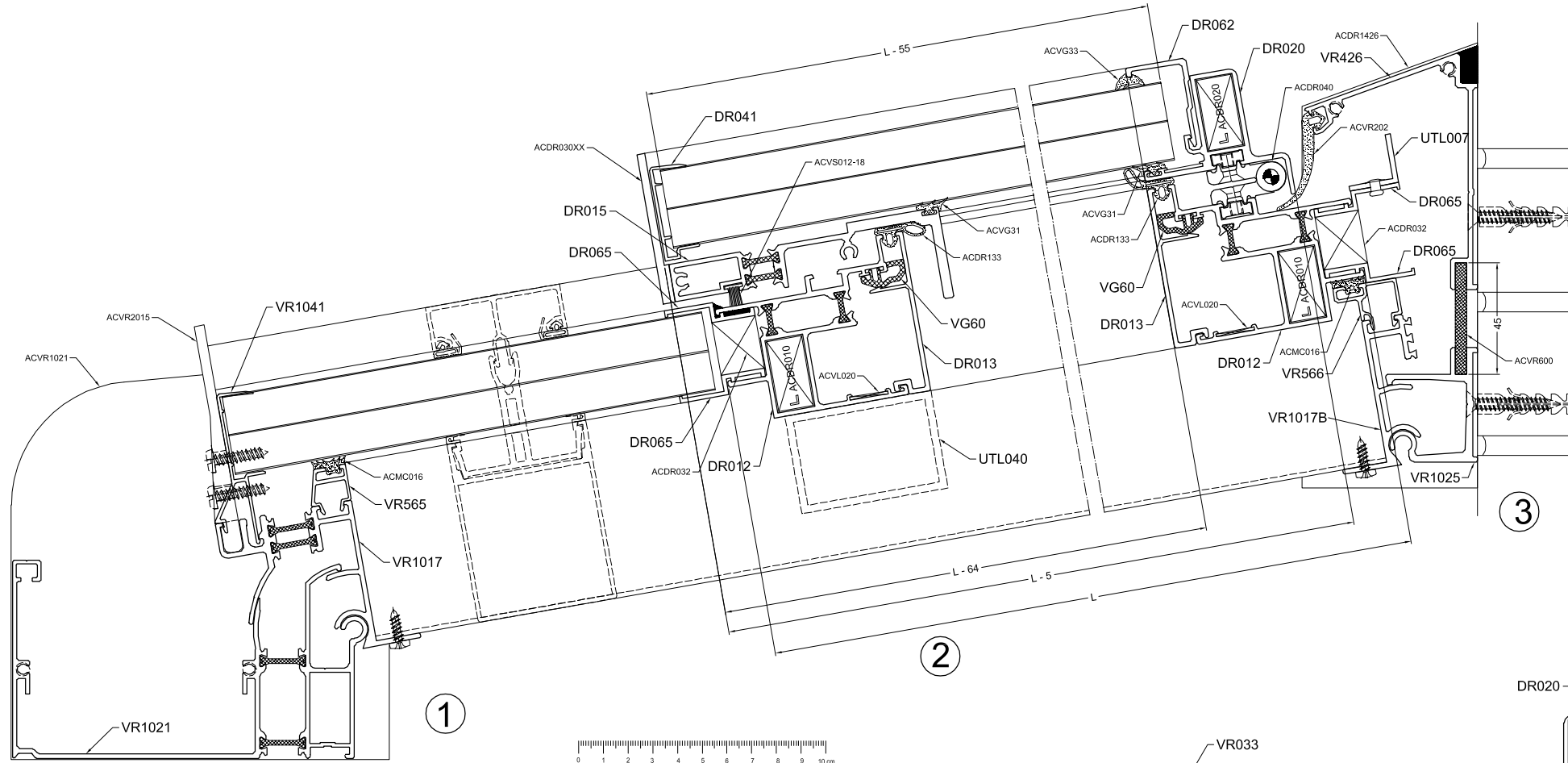

PROFIELN PROFILES PROFILE PROFILS

DR012+13+VG60		2		A + 30
DR012+13+VG60		2		L
DR020		1		L - 5
DR020		1		L - 5
DR020		1		A - 15
DR015		1		A - 25
DR062		1		A - 82
DR062		2		L - 65
DR065		4		A + 30
DR041		1		A - 107
UTL007		1		A + 30

UTL040		1		A
--------	--	---	--	---

TOEBEHOREN ACCESSOIRES ZUBEHORTEILE ACCESSORIES

ACDR010	4
ACDR020	2
ACVL020	6
ACDR030	1 PAAR
ACDR040	2 OF/OU 3
ACVG31	2L+2A-400
ACVG33	2L+A-200
ACDR133	2L+2A-200
ACVS012-18	A-66
ACDR032	8

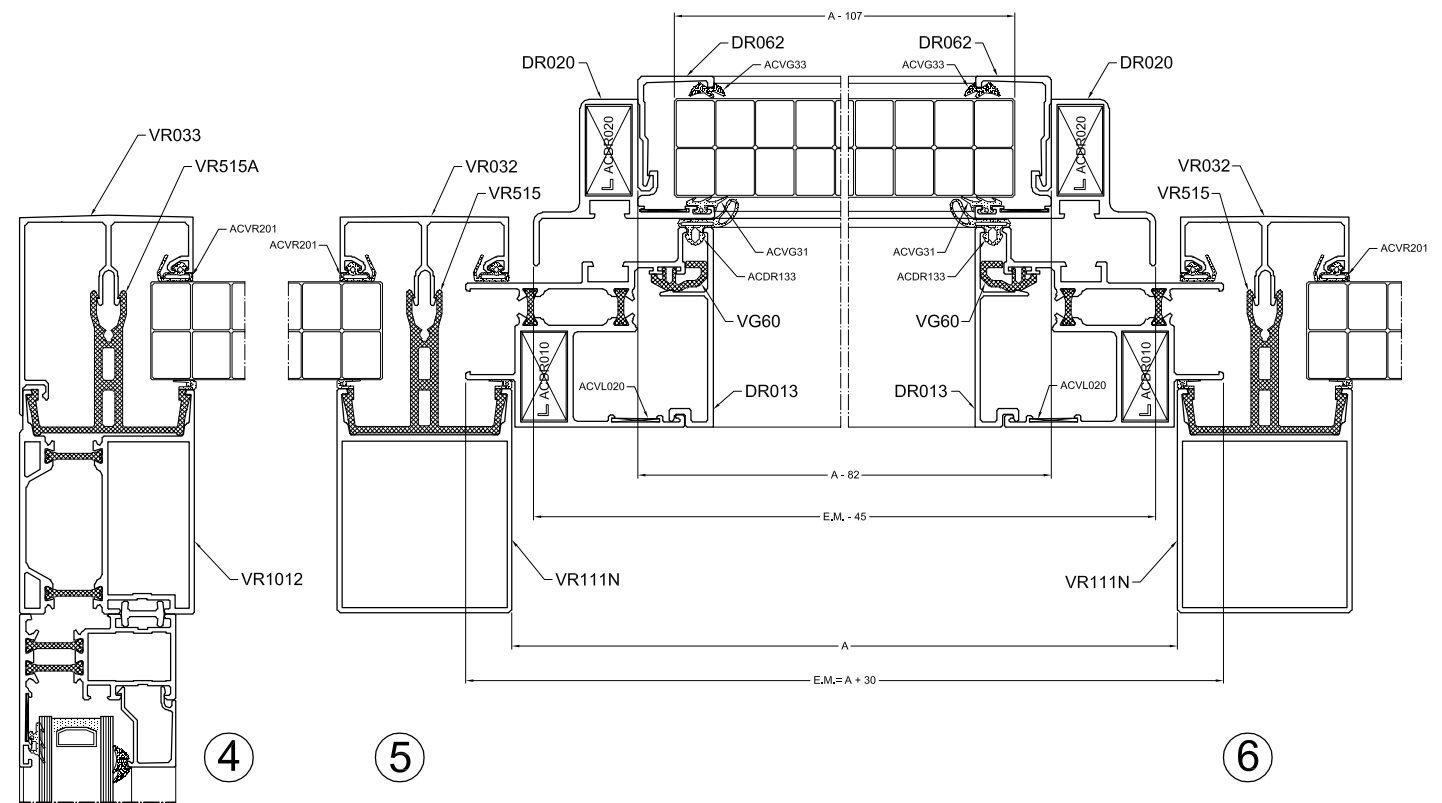

zaag03

MONTAGE MANUELE BEDIENING MET ACDR610/611  
 MONTAGE COMMANDE MANUELLE AVEC ACDR610/611  
 MONTAGE MANUELE BEDIENUNG MIT ACDR610/611  
 MONTAGE OPERATION BY HAND WITH ACDR610/611

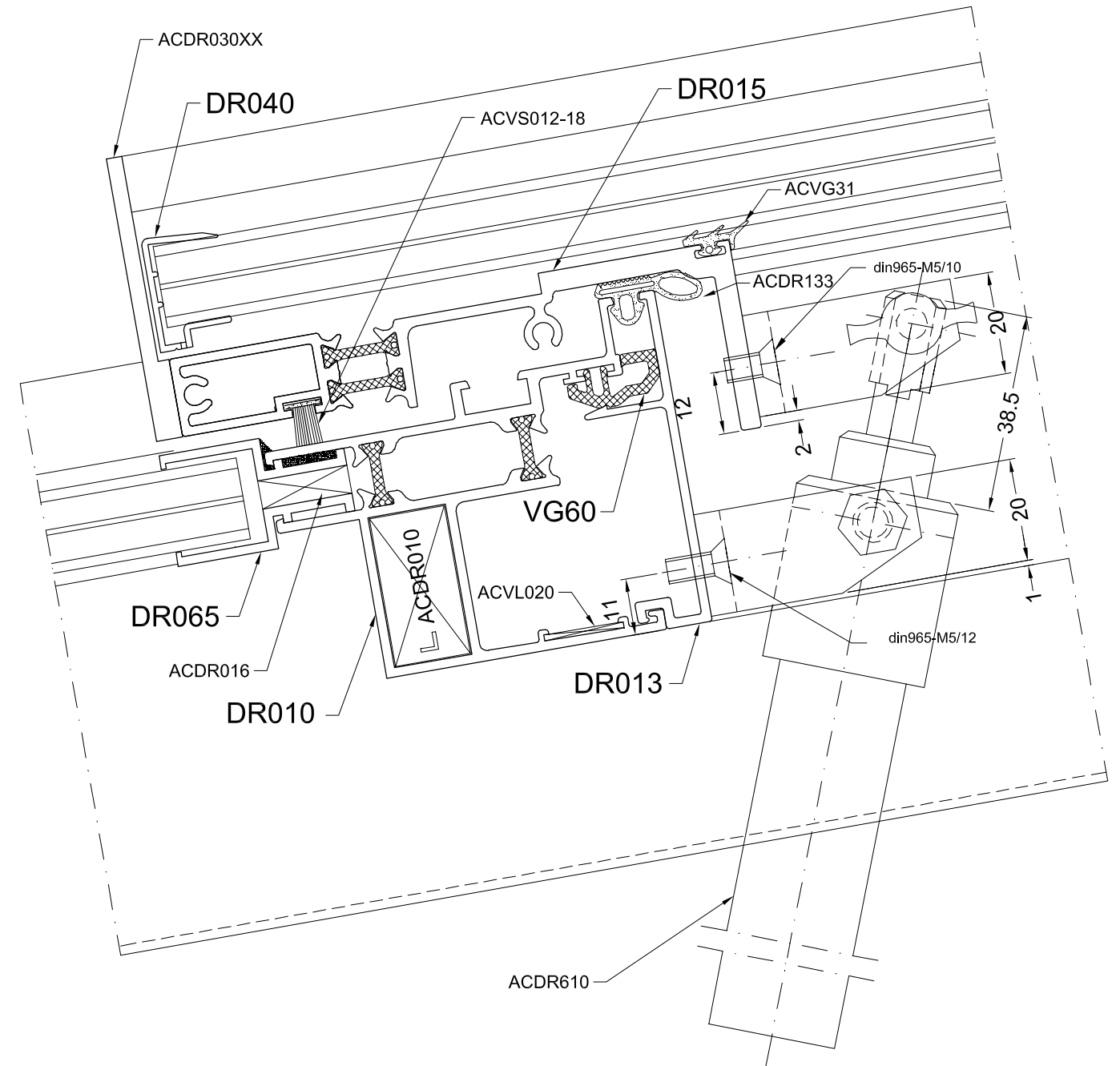
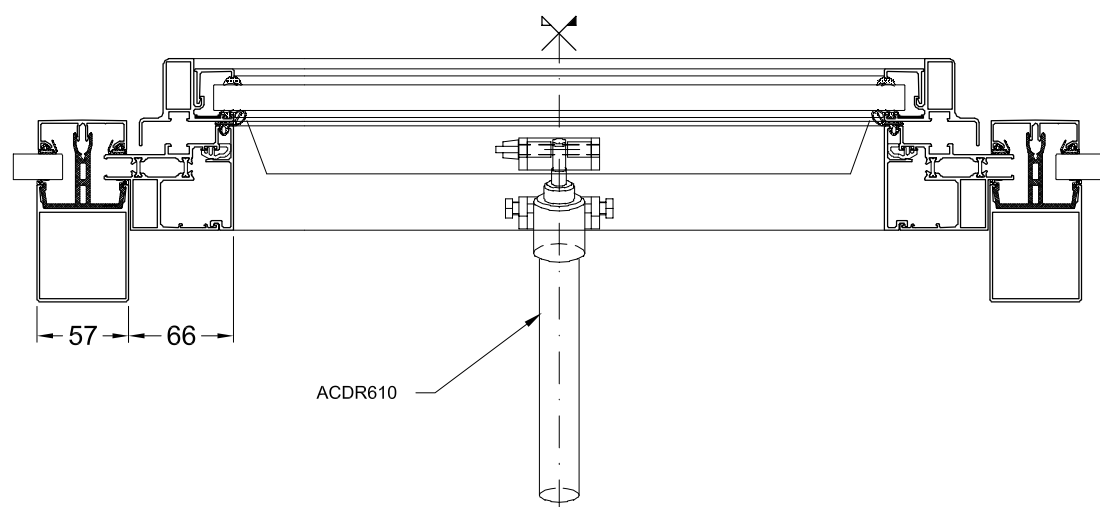
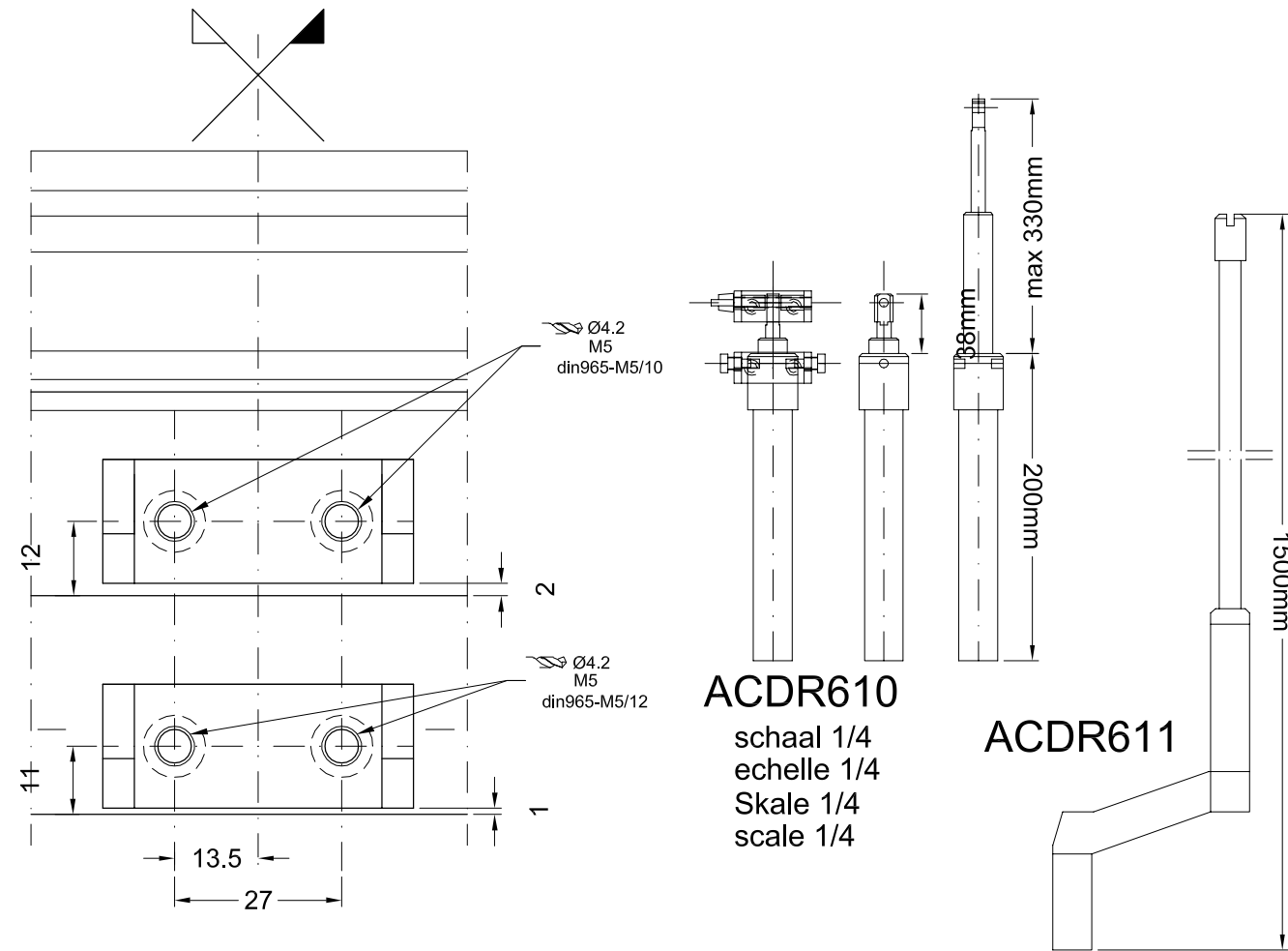

MONTAGE ACDR030  
 MONTAGE ACDR030  
 MONTAGE ACDR030  
 MONTAGE ACDR030

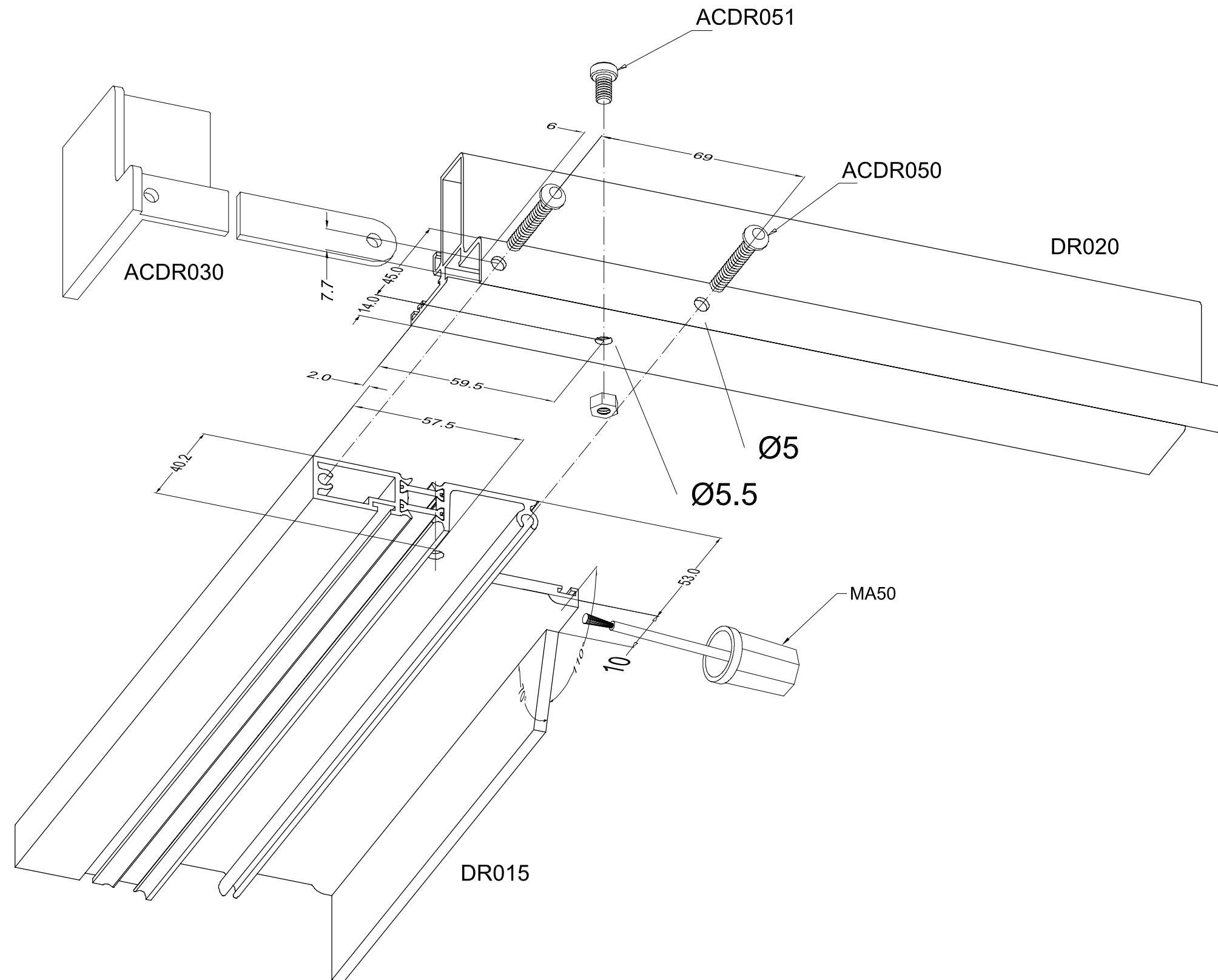

ONTWATERING VOOR DAKRAAM  
DRAINAGE POUR TABATIERE  
ENTWASSERUNG FÜR DACHFENSTER  
DRAINING FOR ROOF LIGHT

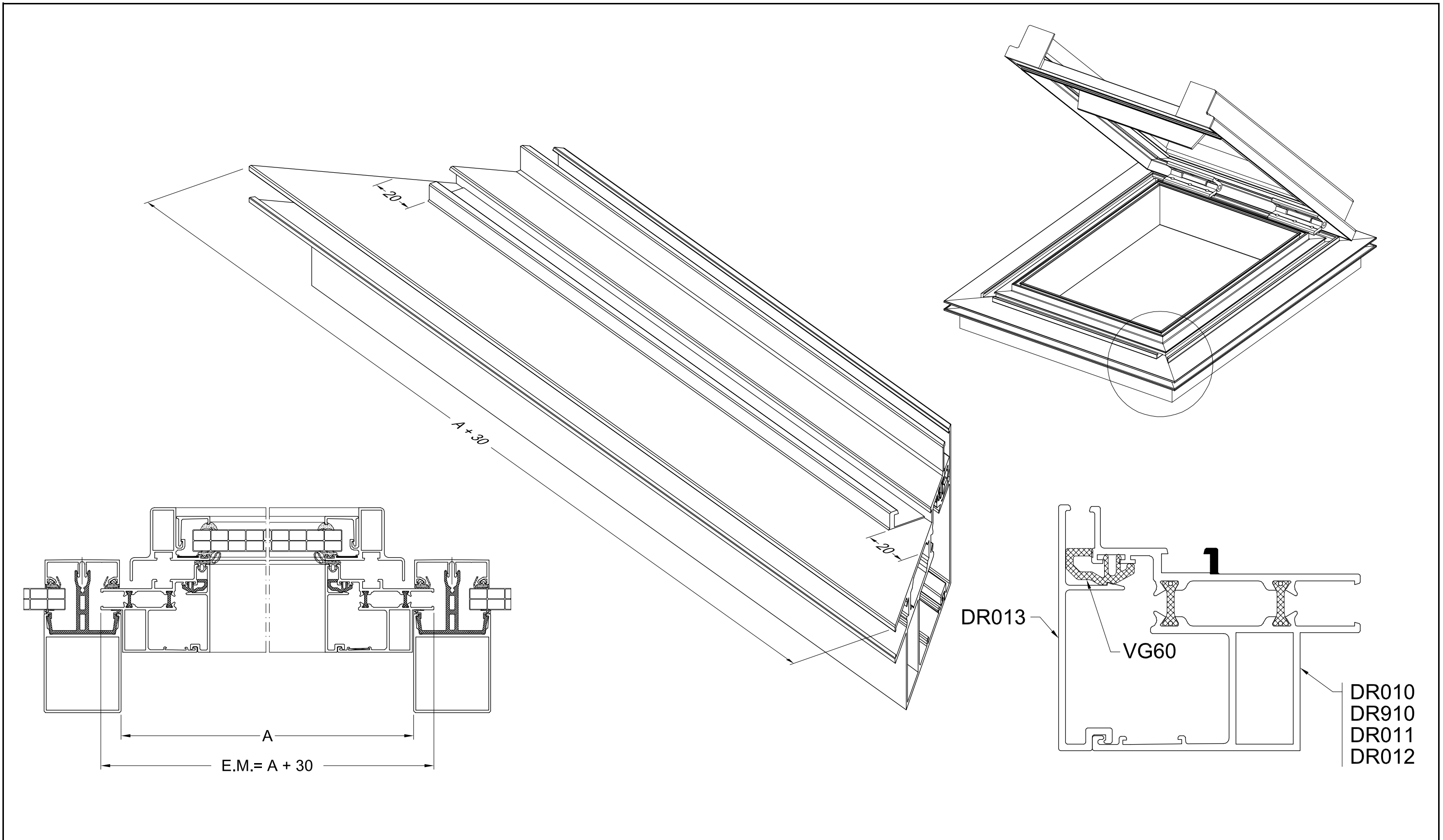



MONTAGE APS017 VOOR VR011N OF VR011V  
 MONTAGE APS017 POUR VR011N OU VR011V  
 MONTAGE APS017 FÜR VR011N ODER VR011V  
 MONTAGE APS017 FOR VR011N OR VR011V

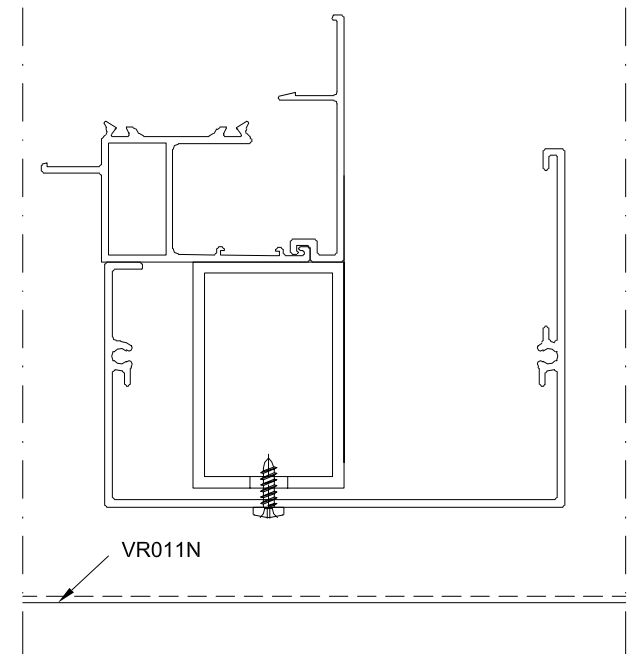
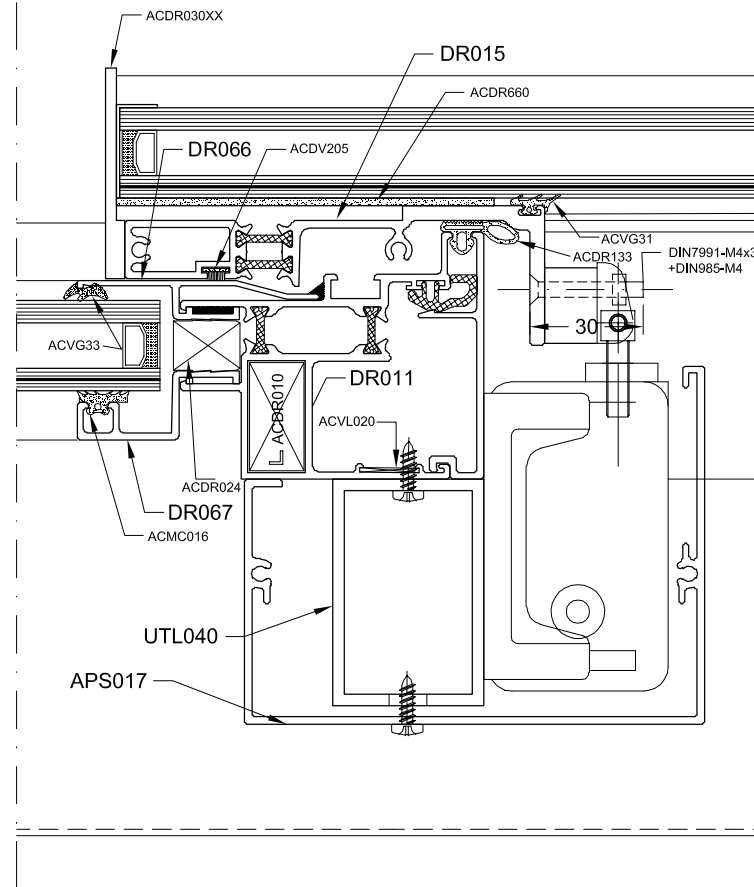
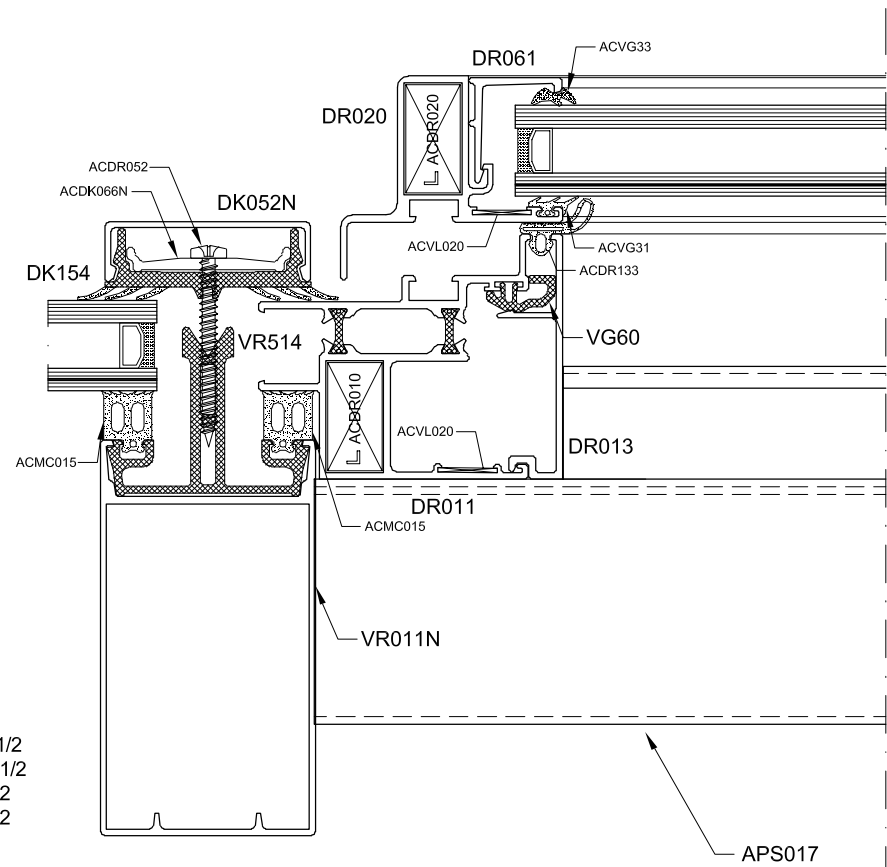
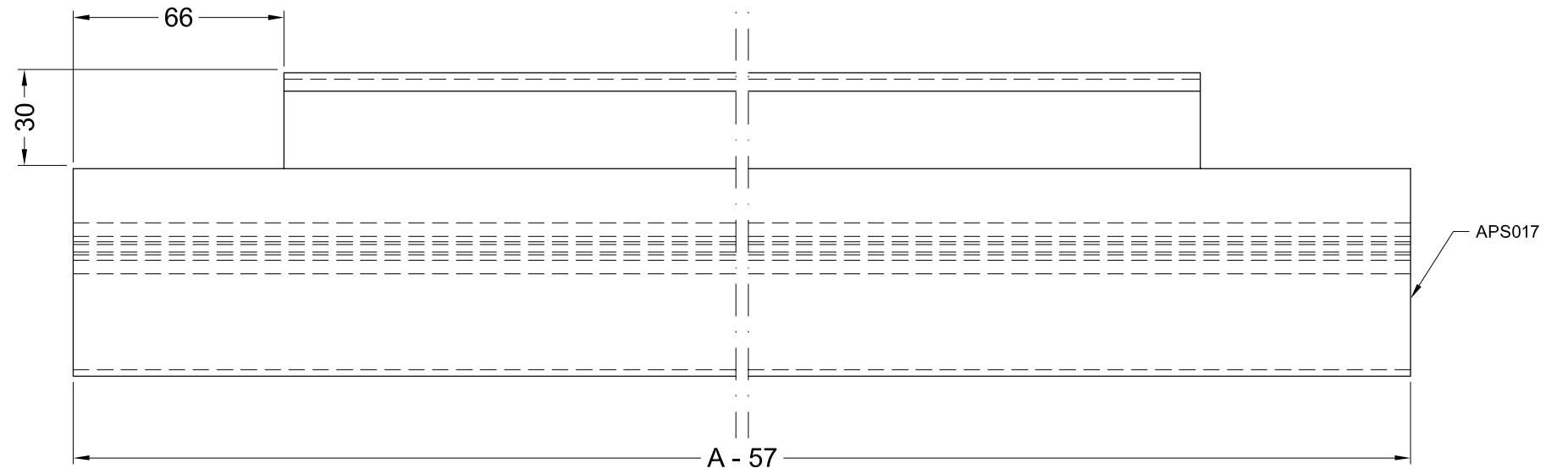
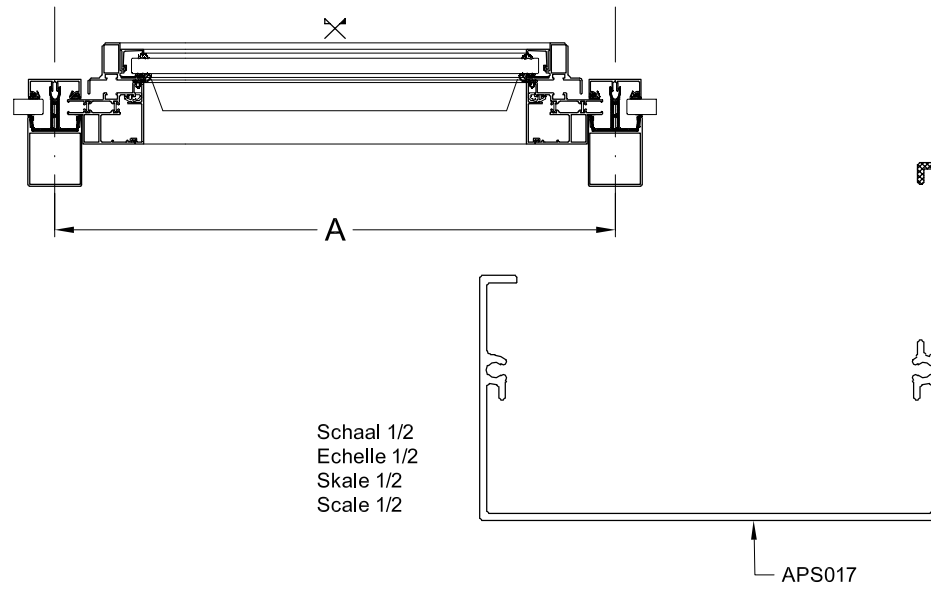

ACDR053

ELECTRISCHE INSTALLATIE ACDR615  
 INSTALLATION ELECTRIQUE ACDR615  
 ELEKTRISCHER ANSCHLUSS ACDR615  
 ELECTRICAL INSTALLATION ACDR615

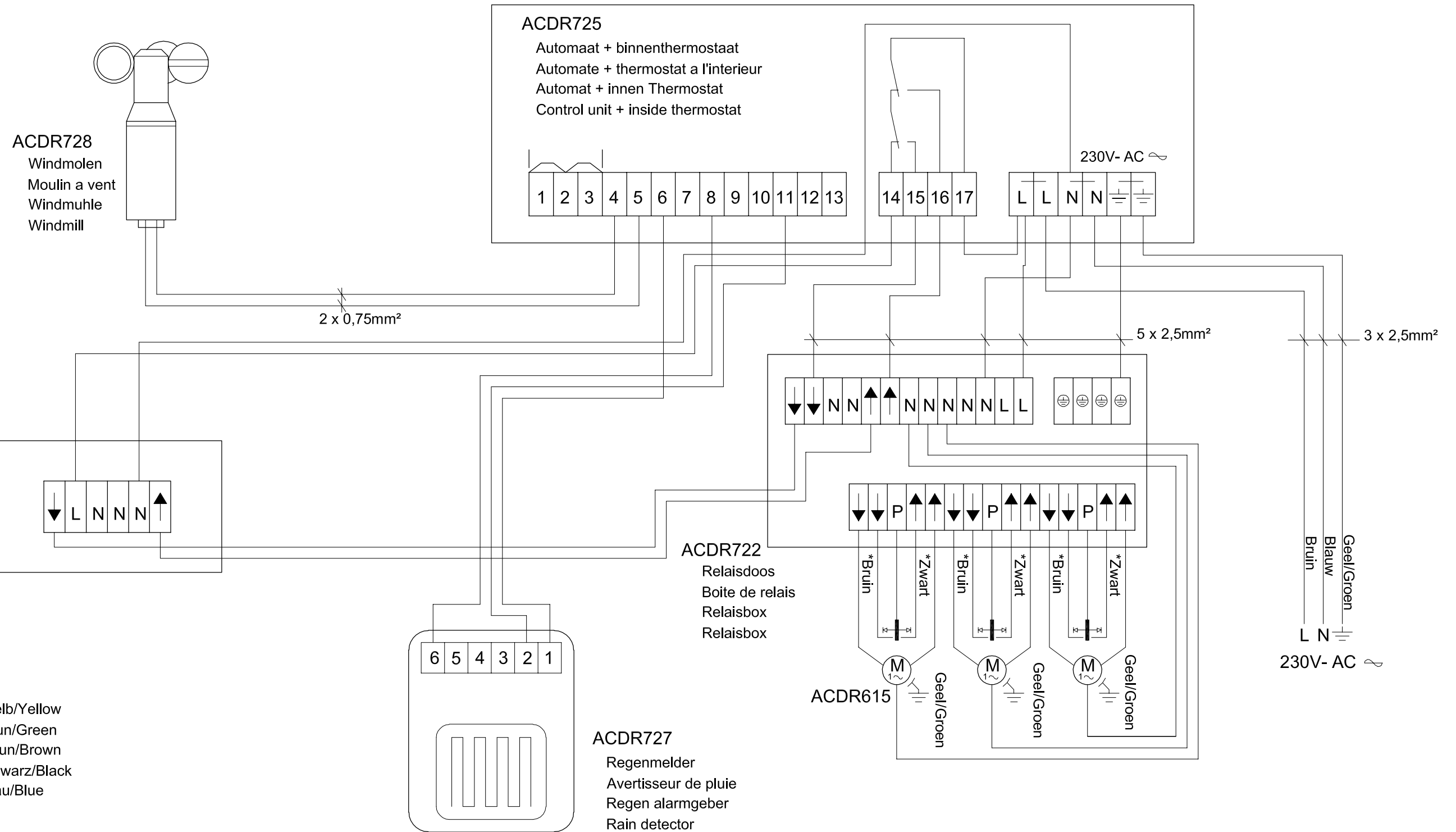

schema15