

SitaVent refurbishment vent



SitaVent
refurbishment vent

Properties

The **SitaVent refurbishment vent** secures the transition into the old vent pipe to be refurbished. It is supplied as a set, containing all the required components. These include the base plate with selected connection sleeve, the rejector and the refurbishment vent pipe with an adapter to the pipe being refurbished and matching multiple-lip EPDM rubber seal. A new warm roof structure can be completed with an additional base plate.

- + For room and section ventilation
- + With integrated selected connection sleeve.
- + Connection to all functional layers
- + For pipe diameters up to 205 mm

Installation example

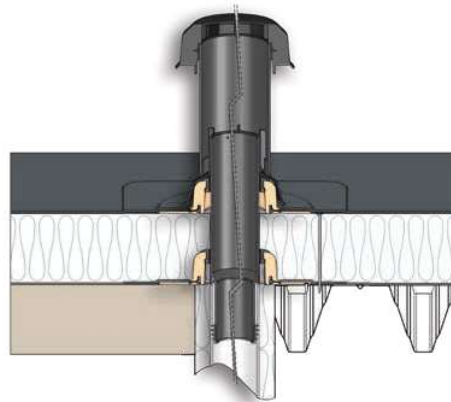

R

SitaVent refurbishment vent	OD*	Backflow safe from (mm)	Base plate DN	Article number
	63	68-86	100	17 30 xx
	75	82-103	100	17 31 xx
	90	100-109	100	17 32 xx
	110	115-130	100	17 33 xx
	125	140-168	150	17 34 xx
	160	178-205	150	17 35 xx

*OD = Outer diameter

SitaVent refurbishment vent

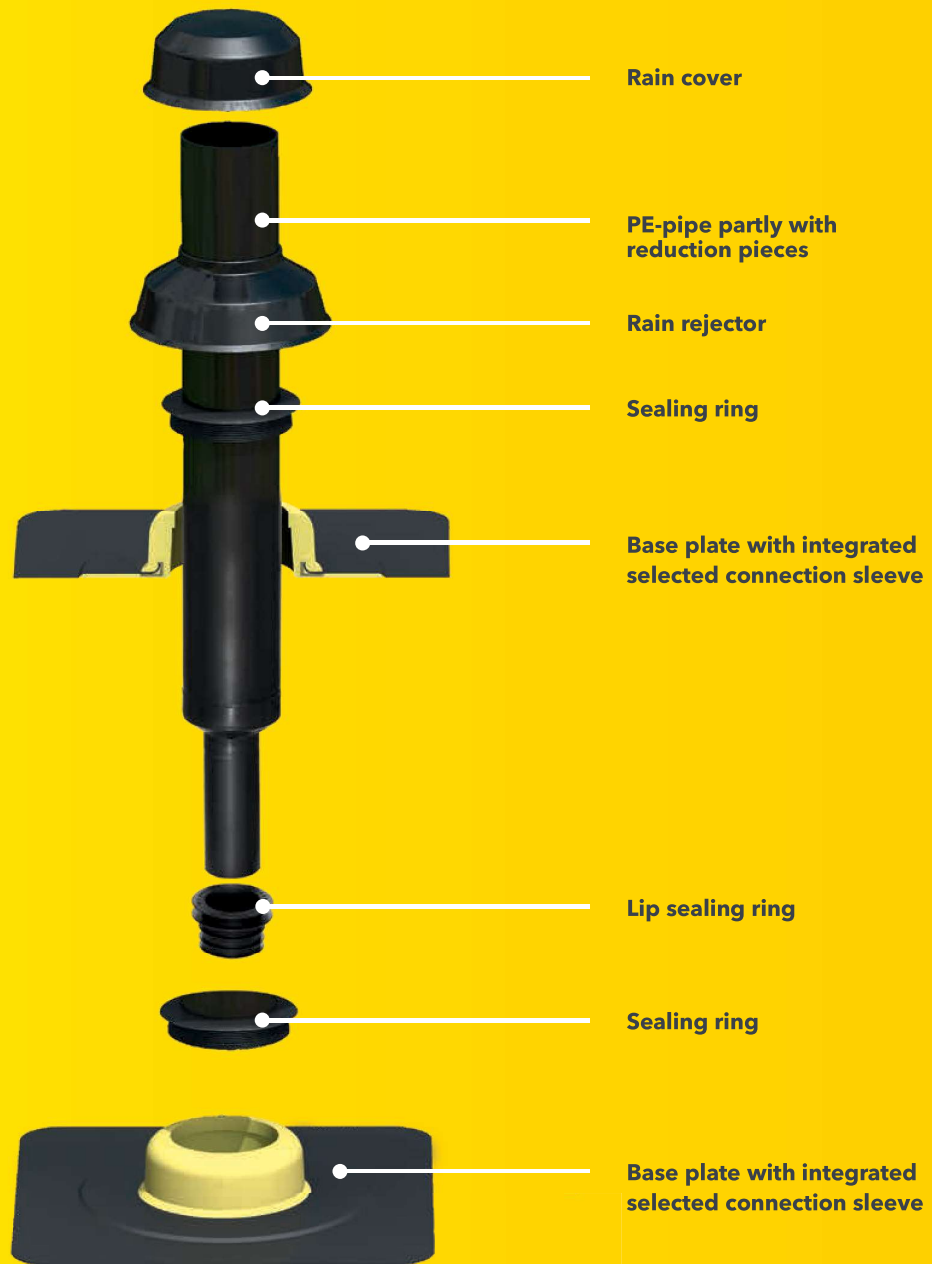

R

This is how easy combinations are generated.

Accessories	Product series									
	SitaSani* 63/90	SitaSani* 95	SitaSani* 110	SitaSani* 125	SitaSani* 165	SitaSani* screw-on flange 63/90 165		SitaSani* 160 DSS	SitaSani* 160 DSS screw-on flange	SitaVent refurbish- ment vent
SitaMore terrace kit	○				○					
SitaTrendy extension unit	○				○	○	○			
SitaCompact terrace kit		○								
SitaCompact extension unit		○								
SitaCompact flat grate		○				○	○			
Sealing ring for SitaSani* 160 DSS								○	○	
SitaVent base plate										○
SitaVent rain cover										○
SitaVent pipe system protective grating										○
SitaVent pipe bend										○
SitaVent vapour barrier cap										○
SitaVent condensation deflector										○





for Ventilation and pipe fairlead

Your building needs ventilation.

A well coordinated system is required to ensure your building can breathe in and out. Our ventilation pipes are integral and provide a perfect connection. We supply you with a comprehensive aeration solution. As your partner for ventilation components, Sita will supply the components you need - whether it is for room, section or cold roof ventilation. Durable, sealed material helps you achieve simple, solid vent solutions from Sita - for a single or dual skin roof.

SitaVent



 SitaVent system vent



 SitaVent pipe fairlead



 SitaVent cold roof vent

Properties SitaVent system vent

The **SitaVent system vent** is the secure roof connection for all room and section ventilation. The base plate including the integrated selected connection sleeve can cover almost every sealing connection. A multi-lip seal provides backflow safety up to a water column of 2 m.

- + For room and section ventilation
- + With integrated selected connection sleeve.
- + Connection to all functional layers

Properties SitaVent pipe fairlead

Made from polyurethane in sizes DN 100 or DN 150. The **SitaVent pipe fairlead** is supplied with an integrated selected connection sleeve to match the roofing membrane, including rain rejector and removable 180° bend.

- + With integrated selected connection sleeve.
- + Can be supplied as cable and pipe fairlead
- + With removable 180° bend
- + Can be combined with the SitaVent vapour barrier cap

Properties cold roof vent

SitaVent cold roof vent made from polyurethane, thermally insulated, with integrated selected connection sleeve, with rain rejector, sealing ring and rain cover. Height 400 mm.

- + For cold roof ventilation
- + With integrated selected connection sleeve.
- + In sizes DN 100 and DN 150

DN	Connecting pipe (mm)	Base plate DN	Article number
70	1000	100	17 42 xx
90	1000	100	17 43 xx
100	750	100	17 44 xx
100	1000	100	17 45 xx
125	1000	150	17 46 xx
150	750	150	17 48 xx
150	1000	150	17 49 xx

DN	Connecting pipe (mm)	Base plate DN	Article number
100	750	100	17 64 xx
100	1000	100	17 65 xx
150	750	150	17 68 xx

DN	Article number
100	17 74 xx
150	17 78 xx

SitaVent



SitaVent Revision



SitaVent condensation deflector

Properties SitaVent Revision

Vapour barrier under control. Is the vapour barrier actually dry? The new **SitaVent Revision** allows a quick check of the status below the thermal insulation at any time. Always in demand from the market, Sita developed the new revision component on the basis of the approved SitaVent.

- + To inspect the vapour barrier
- + Including fixing for a thermal insulation core
- + Alternatively to support a thermo-hygrometer
- + With integrated selected connection sleeve.
- + Secures the vapour barrier cap with a pipe clip

SitaVent Revision	DN	Article number
	100	17 80 xx
	150	17 81 xx

Installation example SitaVent Revision

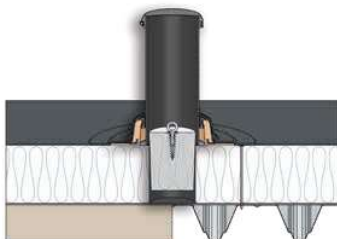

Properties SitaVent condensation deflector

SitaVent condensation deflector: Fully sealed. Moisture is the enemy of any structure. That is why Sita developed the new SitaVent condensation deflector which prevents condensation dripping through the vent pipe back into the building. This product extension is used with the SitaVent system bent and/or SitaVent refurbishment vent.







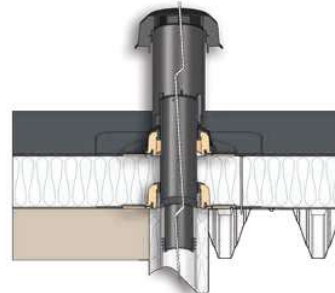













- + Simple installation
- + Secure fixing against wind loads
- + Condensation is discharged straight onto the waterproofing
- + Suitable for SitaVent pipes DN 100

SitaVent condensation deflector	Component length (mm)	Article number
	400	17 12 00

Installation example SitaVent condensation deflector

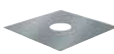

This is how easy combinations are generated.

Accessories	Product series						
	SitaVent system vent	SitaVent pipe fairlead	SitaVent cold roof vent	SitaVent Revision	SitaVent refurbishment vent	SitaVent Fireguard®	
							
SitaVent base plate							
SitaVent rain cover							
SitaVent protective grating							
SitaVent condensation deflector							
SitaVent vapour barrier cap							
SitaMore reinforcement plate							
SitaVent 180° bend		