



# dFend Hydroclean specifier



Protecting against life's little knocks



## SDS dFend Hydroclean: the hygienic wall sheeting system

**SDS are specialists. For over 35 years SDS has focused on Wall, Door and Corner Protection systems, supplying a wide range of sectors including Healthcare, Education, Recreation, Pharmaceutical and Retail. One of the essential products SDS brings to the market is dFend Hydroclean: the hygienic, resilient wall cladding solution.**

When creating sterile environments such as cleanrooms, food production areas, drug manufacturing production lines, operating theatres, general washrooms and other similarly sanitized zones, then **SDS dFend Hydroclean** should be specified. This excellent and versatile

sheet material can be applied to every wall surface, and, using the in-house expertise of SDS, laminated around all door and frame sets that exist in these vicinities. This wall, door and frame encapsulation service presents a new and significant opportunity to the Specifier, when colour schemes, colour contrasts and DDA compliance can all be instigated – but still in conjunction with the requisite hygiene standards!

Using the **SDS dFend Hydroclean** system is pivotal in creating well designed environments that won't compromise the activities designated to those germ-free areas.



**Protecting against life's little knocks**

# thermoforming jointing and transitions

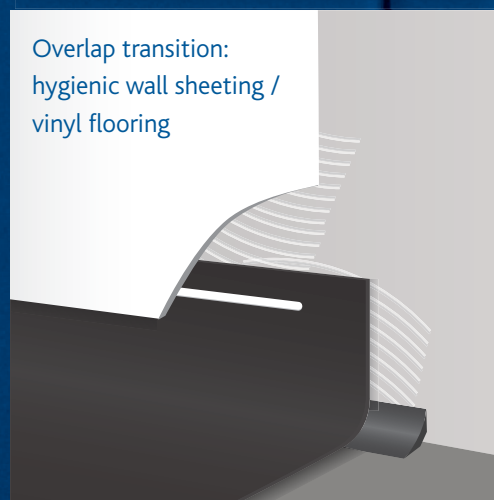
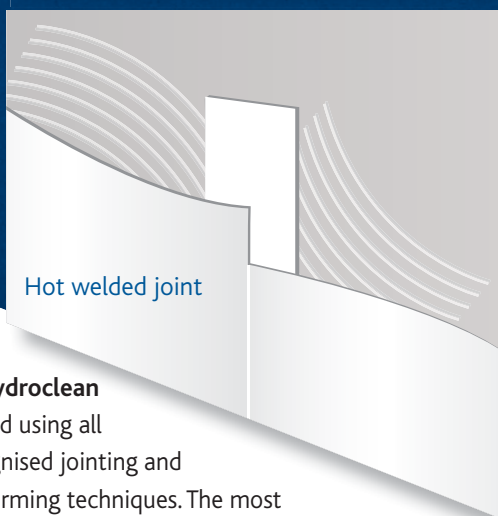
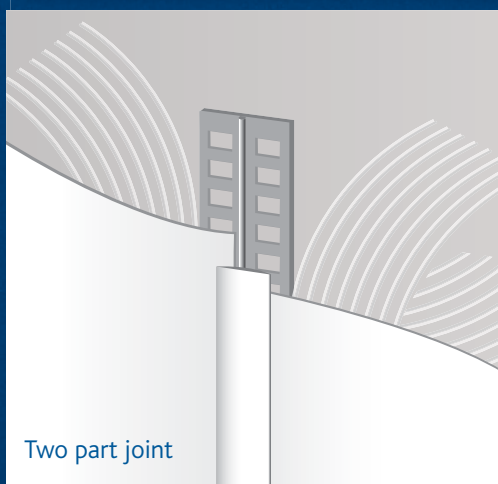
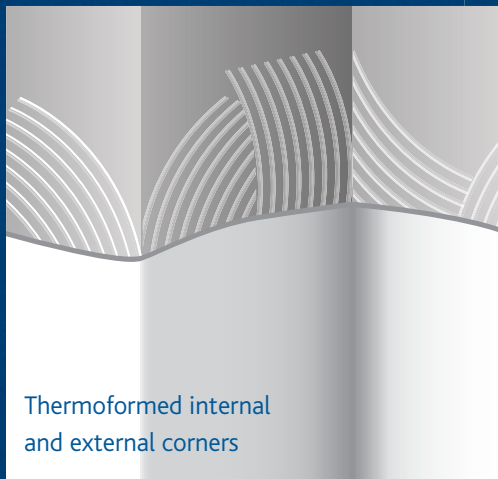

**dfend Hydroclean** is installed using all the recognised jointing and thermoforming techniques. The most compelling reason to specify **dfend Hydroclean** lies in the readiness of SDS to provide a supply and install service where the quality product is backed by a quality installation!

# SDS dFend Hydroclean doorsets

SDS dFend Hydroclean postformed doorsets help you extend the functionality of the hygienic wall cladding onto doorsets themselves. This means that the effectiveness of the hygienic sheet doesn't terminate at the door frame abutments, but rather, using the in-house capacity of SDS, extends to completely encapsulating the frame and the door. SDS is unique: in offering this service directly from our factory (with no third party involvement necessary) we retain tight control of design, quality and turnaround times.

To learn more about SDS postformed **dFend Hydroclean** doorsets, contact SDS to request a colour swatch or even a hinged working door sample.



Protecting against life's little knocks



## dFend panels

To co-ordinate your design approach, consider the potential of using **dFend Hydroclean** encapsulated panels and boards.

Whether incorporated in the manner of IPS panels, used as hatchways, or utilised as access boxing to conceal pipe runs, SDS can provide all shapes and sizes of moisture resistant boards postformed in **SDS dFend Hydroclean** sheeting. A great opportunity to augment a colour scheme with panels that would traditionally be considered unattractive and utility items!

# the SDS hydroclean sheeting specifier

## Hygienic Wall Cladding 850

Drawing Ref	<i>Please supply project refs</i>
Manufacturer	<b>SDS Protection Ltd. Tel: 01420 543222</b>
Material	<b>dFend Hydroclean</b> thickness: 2.5mm
Colour	<i>Choose from colour chart</i>
Install with long edges	Vertically <b>or</b> Horizontally
Wall joint	Two part trim* <b>or</b> Hot welded
Flooring Transition	Two part trim* <b>or</b> Overlap (specify overlap distance)
Seal: perimeter ceiling/ door & window frames	Mastic as Clause 970
Finish as delivered	Factory
Notes:	<i>Please add any special instructions</i>

\*subject to colour availability - contact SDS to confirm

## the SDS hydroclean panel specifier

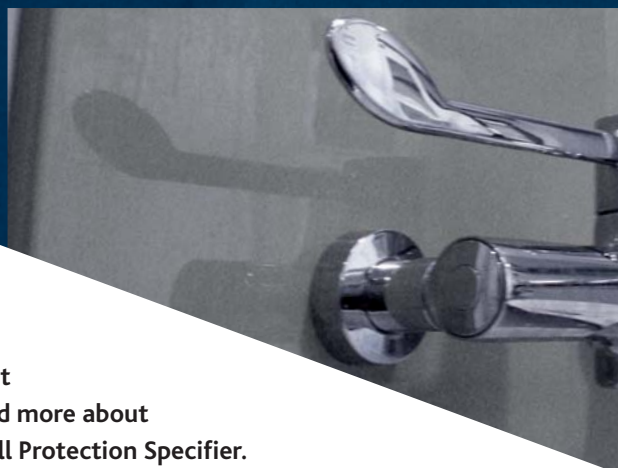

Remember too, that SDS offers a wide variety of crash rails and buffer guards in stainless steel, plastic, timber and rubber materials to suit almost every conceivable application. Read more about these products and profiles in the SDS Wall Protection Specifier.



the SDS dFend Hydroclean specifier



Protecting against life's little knocks

### Sheeting Specification – example

#### Hygienic Wall Sheet 850

Drawing Ref	Sample 010806
Manufacturer	SDS Protection Ltd Tel: 01420 543222
Reference	dFend Hydroclean
Thickness	2.5 mm
Colour	Pastels: Splash Blue
Install	Vertically
Wall Joints	Hot Welded
Floor Transition	Overlap - 100mm
Seal	Mastic as clause 970
Finish as delivered	Factory

NOTES Room to have one feature wall

### Panel Specification – example

#### Postformed Hygienic Panels 875

Drawing Ref	Sample 010806
Manufacturer	SDS Protection Ltd Tel: 01420 543222
Finish	dFend Hydroclean
Thickness	22 mm
Colour	RAL 5003 Sapphire Blue
Edges	All four edges clad
Finish as delivered	Factory

NOTES Panels to match feature wall

### Doorset Specification – example

#### Postformed Hygienic Doorset 410

Drawing Ref	Sample 010806
Manufacturer	SDS Protection Ltd Tel: 01420 543222
Reference	dFend Hydroclean
Fire Rating	FD60
Door Core	Solid block
Extra Sound Reduction	Required – target 39 dB
Facing Colour	Peppermint
– contrasting leading edge	Yes – RAL 5003 Sapphire Blue

#### Glazing

Vision Panel	VPA4
Glass Type	Frosted
Beading	Plastic Bead Cover

#### Frame

Style	Traditional
Frame Core	Hardwood

Finish as delivered Factory

NOTES Twin seal 20x4 intumescent (LP2004TS)  
Plastic Bead Cover in 'splash' colour

### Colour Chart:

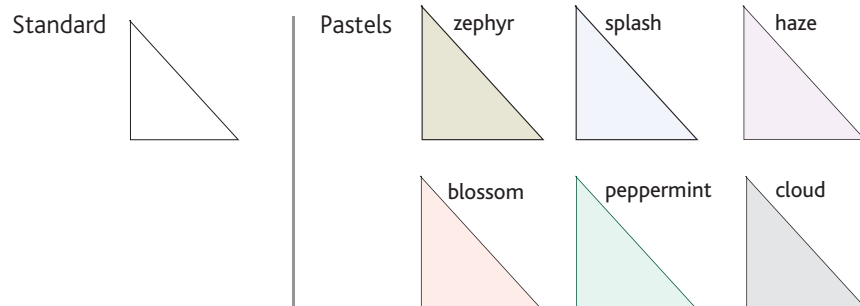

**Vibrance Gloss Finish:** We can match to any RAL or Pantone colour – contact SDS to discuss your specific requirements

**Note:** Colour matching subject to minimum quantity/leadtime.



SDS is accredited to:  
BS EN ISO 9001:2000

CHAS accredited

# the SDS hydroclean doorset specifier

## Doorset 410

Drawing Ref	<i>Please supply project refs</i>
Manufacturer	<b>SDS Protection Ltd. Tel: 01420 543222</b>
Reference	<b>SDS Hydroclean Doorset</b>
Fire Rating	 FD60    FD30    not rated
	<small>Doorsets are certified and in accordance with BS 476: Part 22: 1987</small>
Door Core: Heavy Duty	Chipboard <i>or</i> Solid Block (lightweight)
Extra Sound Reduction	Not required <i>or</i> <i>if</i> Required – specify target dB rating _____dB
Facing Colour	<i>Choose from colour chart</i>
Contrasting Leading Edge	Yes ( <i>please specify colour</i> ) <i>or</i> No

## Glazing Details

### Vision Panels

size and location – *please state VP code*

VPA1

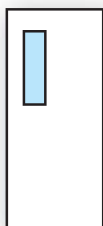

Aperture:  
750 x 200

VPA3

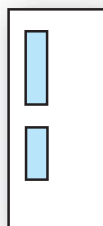

Apertures:  
750 x 200  
488 x 200

VPA4



Aperture:  
1450 x 200

VPA10

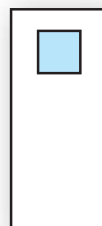

Aperture:  
404 x 404

VPA11

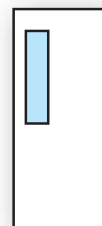

Aperture:  
805 x 255

VPA12/13

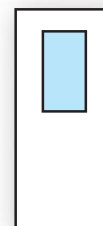

Aperture:  
VPA12: 750 x 400  
VPA13: 750 x 500

### Glass Type



### Beading

Note: Flush Glazed only available on leaves with single apertures.

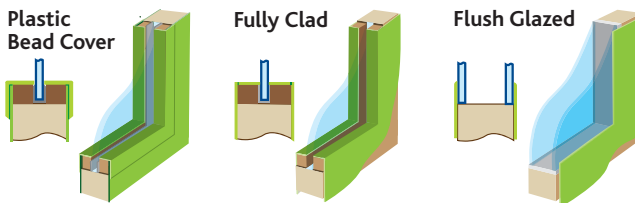

## Frame Details

### Style

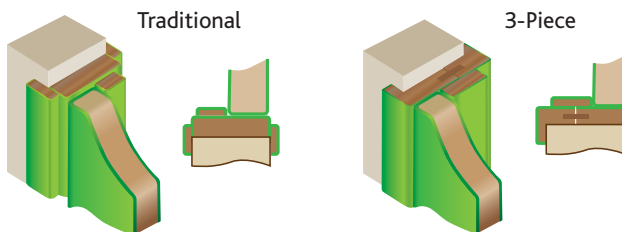

Frame core    Softwood *or* Hardwood

Notes    *Please add any special instructions*

### NOTES:

For a full specification please include all categories as shown.

Where custom items are required please provide full drawings and specifications.

Due to the limitations of the printing process, actual colours may vary slightly from swatches shown. For an accurate colour match please ask SDS Protection for samples.

Disclaimer: SDS Protection Ltd reserves the right to make changes to designs or specifications, or to withdraw any design without notice

# SDS Protection solutions



## SDS Protection dFendor

dFend durablend sheeting is used on the SDS range of dFend doors and doorsets.

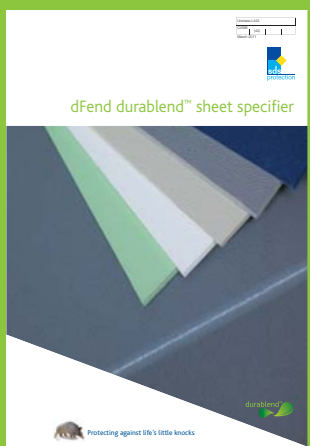

## SDS Protection dFend durablend™ sheeting

dFend durablend sheeting for wall protection



## SDS Protection Wall protection

A comprehensive range of rails and protection suitable for all applications.



SDS Protection Limited  
Wyck Crossroads  
Binsted Road | ALTON  
HANTS | GU34 4NT  
T: 01420 543222  
F: 01420 543355

[sales@sdsprotection.co.uk](mailto:sales@sdsprotection.co.uk)  
[www.sdsprotection.co.uk](http://www.sdsprotection.co.uk)



Protecting against life's little knocks