

Copyright:
 Copyright and design is owned by
 SA Solutions Ltd

Patent:
 Intellectual rights are owned by
 SA Solutions LTD
 UK Patent No. 2429022

APPROVED BY TECHNICAL / DATE

APPROVED BY SALES / DATE



SA SOLUTIONS
 GIVES YOU THE EDGE

**Seamless Abutments
 Solutions Ltd**

Solutions House
 16 Bellrope House
 Samford Road
 Thaxted, Essex
 CM6 2FE
 ENGLAND
 Tel: +44 1371 832 152
 Fax: +44 1371 831 983
 Email: info@seamlessabutments.com

Title
 100mm Split Skirting 12mm shadow gap /
 12.5mm board skim finish

Original / Scale	Drawn	Date
1:1 @ A4	KR	06-04-2017

Drawing Number

01-sp-sk

Copyright:

Copyright and design is owned by SA Solutions Ltd

Patent:

Intellectual rights are owned by SA Solutions LTD
UK Patent No. 2429022

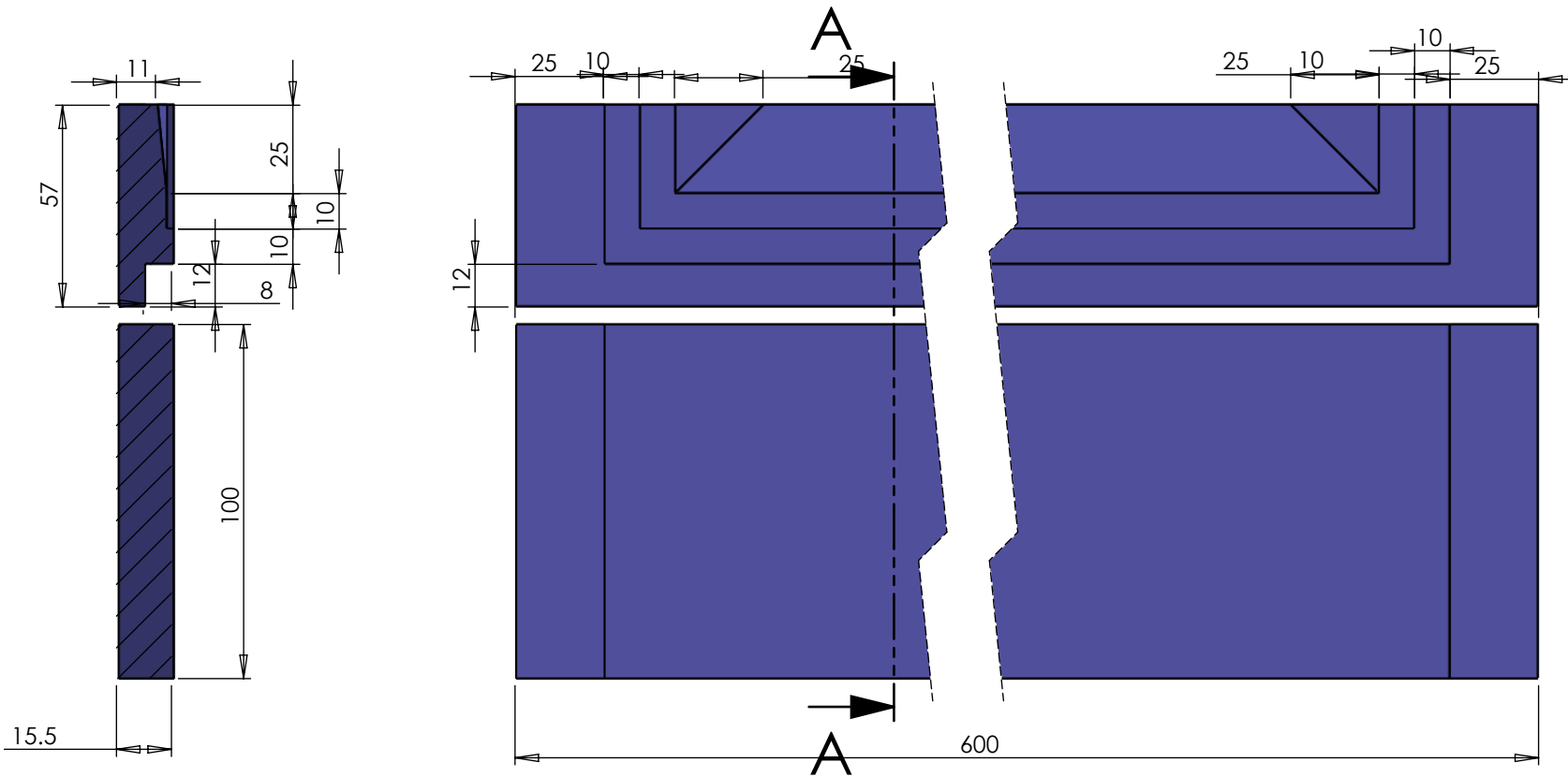

SECTION A-A
SCALE 1 : 2

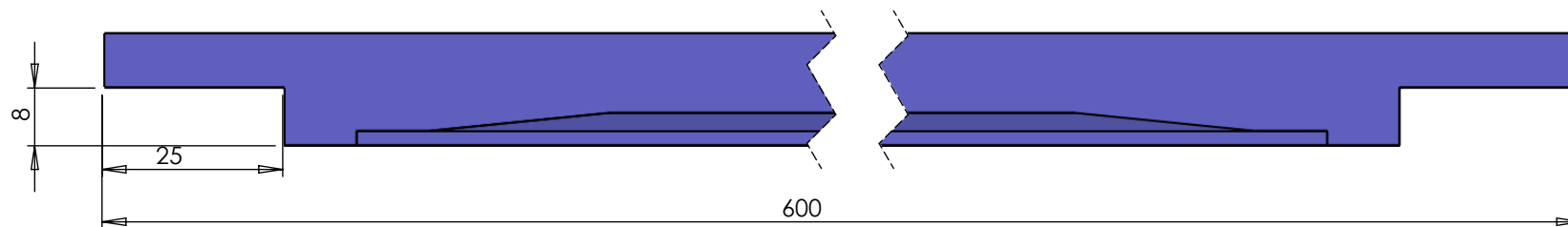

APPROVED BY TECHNICAL / DATE

APPROVED BY SALES / DATE



SA SOLUTIONS
GIVES YOU THE EDGE

**Seamless Abutments
Solutions Ltd**

Solutions House
16 Bellrope House
Samford Road
Thaxted, Essex
CM6 2FE
ENGLAND

Tel: +44 1371 832 152
Fax: +44 1371 831 983
Email: info@seamlessabutments.com

Title

100mm Split Skirting to architrave transition
12mm shadow gap /12.5mm board skim finish

Original Scale	Drawn	Date
1:2 @ A3	KR	04-04-2017

Drawing Number

02-sp-sk

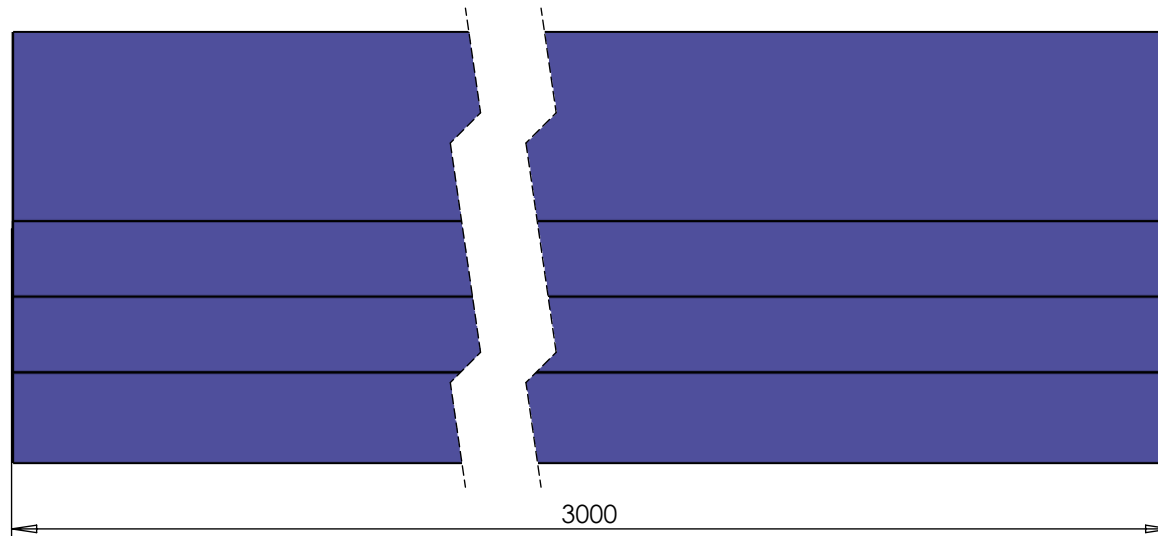
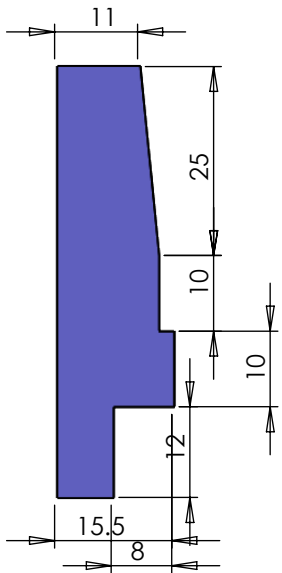

SA BC3 Architrave Vertical 12mm shadow gap /12.5mm board skim edge @3000MM

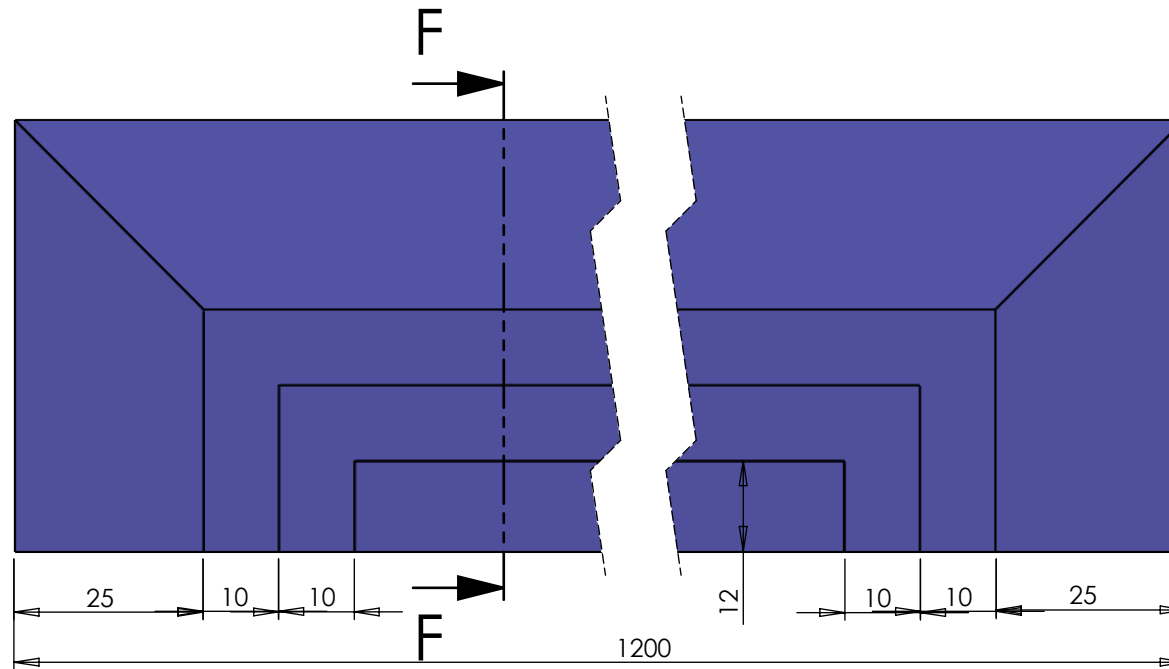
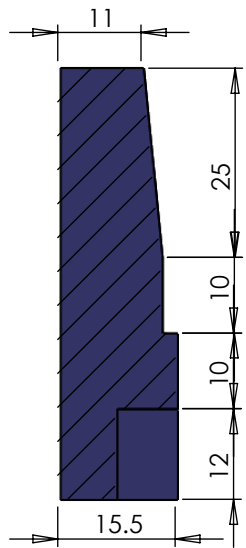

SA BC4 Architrave Head 12mm shadow gap /12.5mm board skim edge @1200MM

SECTION F-F
SCALE 1 : 1

Copyright:
Copyright and design is owned by
SA Solutions Ltd

Patent:
Intellectual rights are owned by
SA Solutions LTD
UK Patent No. 2429022

APPROVED BY TECHNICAL / DATE

APPROVED BY SALES / DATE



SA SOLUTIONS
GIVES YOU THE EDGE

**Seamless Abutments
Solutions Ltd**

Solutions House
16 Bellrope House
Samford Road
Thaxted, Essex
CM6 2FE
ENGLAND

Tel: +44 1371 832 152
Fax: +44 1371 831 983
Email: info@seamlessabutments.com

Title
Architrave Vertical & Head sections 12mm
shadow gap /12.5mm board skim finish

Original Scale	Drawn	Date
1:1 @ A3	KR	04-04-2017

Drawing Number

03-sp-sk

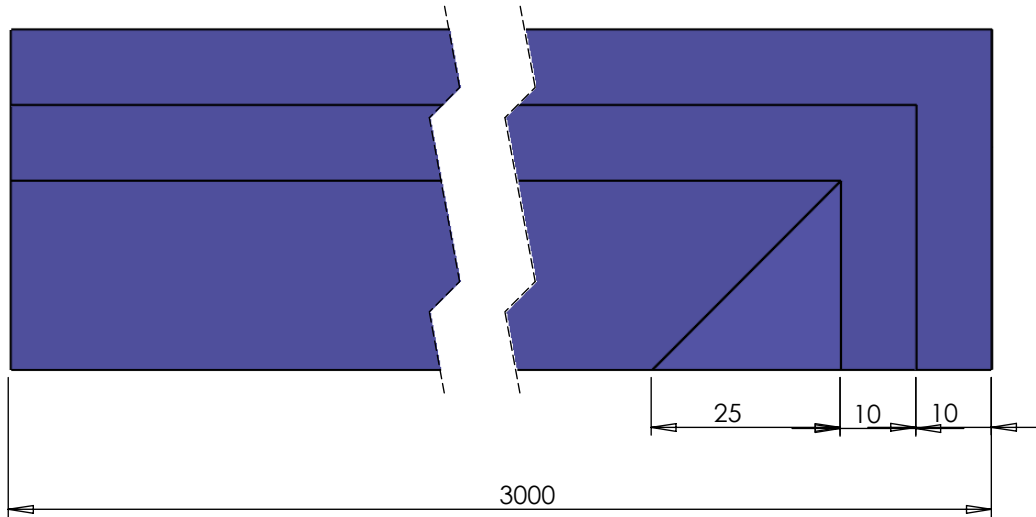
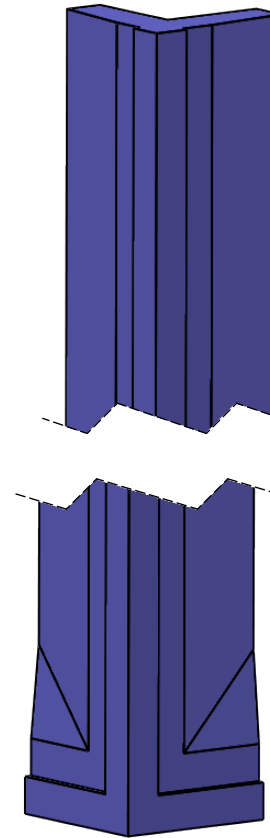
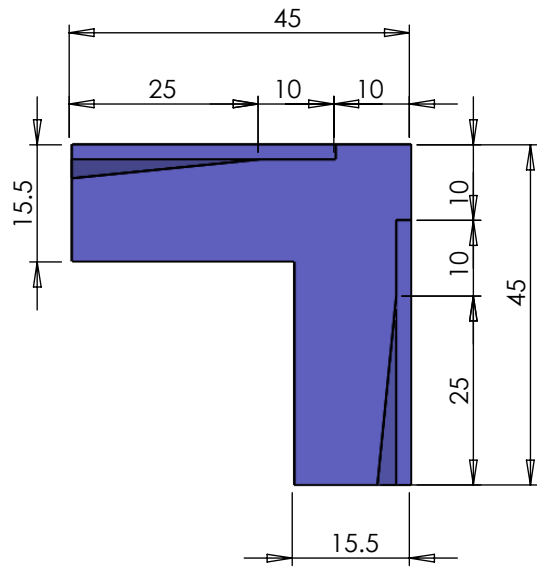

Copyright:
 Copyright and design is owned by
 SA Solutions Ltd

Patent:
 Intellectual rights are owned by
 SA Solutions LTD
 UK Patent No. 2429022

APPROVED BY TECHNICAL / DATE

APPROVED BY SALES / DATE



SA SOLUTIONS
 GIVES YOU THE EDGE

**Seamless Abutments
 Solutions Ltd**

Solutions House
 16 Bellrope House
 Samford Road
 Thaxted, Essex
 CM6 2FE
 ENGLAND
 Tel: +44 1371 832 152
 Fax: +44 1371 831 983
 Email: info@seamlessabutments.com

Title
 Square External Corner 12.5mm board skin
 finish with transition at base

Original / Scale	Drawn	Date
1:1 @ A3	KR	04-04-2017

Drawing Number
 04-sp-sk

Copyright:

Copyright and design is owned by SA Solutions Ltd

Patent:

Intellectual rights are owned by SA Solutions LTD
UK Patent No. 2429022

APPROVED BY TECHNICAL / DATE

APPROVED BY SALES / DATE



SA SOLUTIONS
GIVES YOU THE EDGE

Seamless Abutments Solutions Ltd

Solutions House
16 Bellrope House
Samford Road
Thaxted, Essex
CM6 2FE
ENGLAND

Tel: +44 1371 832 152

Fax: +44 1371 831 983

Email: info@seamlessabutments.com

Title

Square External Corner 12.5mm board
skim finish

Original / Scale	Drawn	Date
1:1 @ A3	KR	04-04-2017

Drawing Number

05-sp-sk

