

POST FORMED
SYSTEMS LTD.

CLASSIC
DESIGN
ARCHITECTURAL
POSTFORMERS



Excellence in Cubicle Washrooms

WASHROOMS BY **DESIGN**



ABOUT US

Welcome to Kingfisher Cubicle Washrooms.

As Architectural Postformers we celebrate over 3 decades in the designing & manufacturing of bespoke cubicle washrooms.

The early manufacturing processes by Post Formed Systems Ltd, was the production of counter tops for commercial and industrial applications. Today the Kingfisher brand of cubicle washrooms is the Companies leading activity in Ireland and the United Kingdom.

SERVICE & QUALITY

At Kingfisher experience counts and our company ethos remains service & quality. In every project we listen carefully to the clients requirements, identifying the surfacing materials most suitable supported by our own best practice designs.

Our commitment to the customer is to then design a modern washroom that is both functional and durable, offering years of quality service.

The contents of our brochure offer flexibility and innovation as a standard for our new commercial washroom collection and dedicated healthcare sector.

Our team looks forward to meeting you and discussing your project plans.

Mark Connolly

Managing Director





CONTENTS

6-13	CUBICLES
15-17	SERVICE WALLS
18-20	VANITY UNITS
21-23	LAMINATED FURNITURE
24-31	HEALTHCARE
32-34	STAINLESS STEEL



CONTENTS

35	SANITARY WARE
36-38	BRASS WARE
39-41	LOCKERS & BENCHES
44-48	TECHNICAL DRAWINGS
49-50	COLOURS

KINGFISHER CUBICLES

Welcome to the Kingfisher collection of cubicle washrooms. Our new range of toilet cubicles are designed and manufactured to offer style, function and durability. Flexibility of design is also catered for in our collection to meet client expectations and room design supported by our bespoke vanity units and Access service walls.

T1



KONTOR CUBICLE

T2



FINESSE CUBICLE

T3



MONDIALE CUBICLE

T4



INTERNATIONAL CUBICLE

T5



ORBIT CUBICLE

T6



ATLAS CUBICLE

T7



TIGER CUB CUBICLE

T8



METRO BESPOKE CUBICLE

KONTOR CUBICLE

The Kontor cubicle system utilises the popular postforming detail on its cubicle doors and pilasters. This system of soft postformed edges is pleasant to the touch and aesthetically pleasing in conjunction with any selected colour.

The key benefit of the Kontor system consists of a pilaster mounted lever lock, an attractive profiled head rail with anti vandal security fixings throughout.

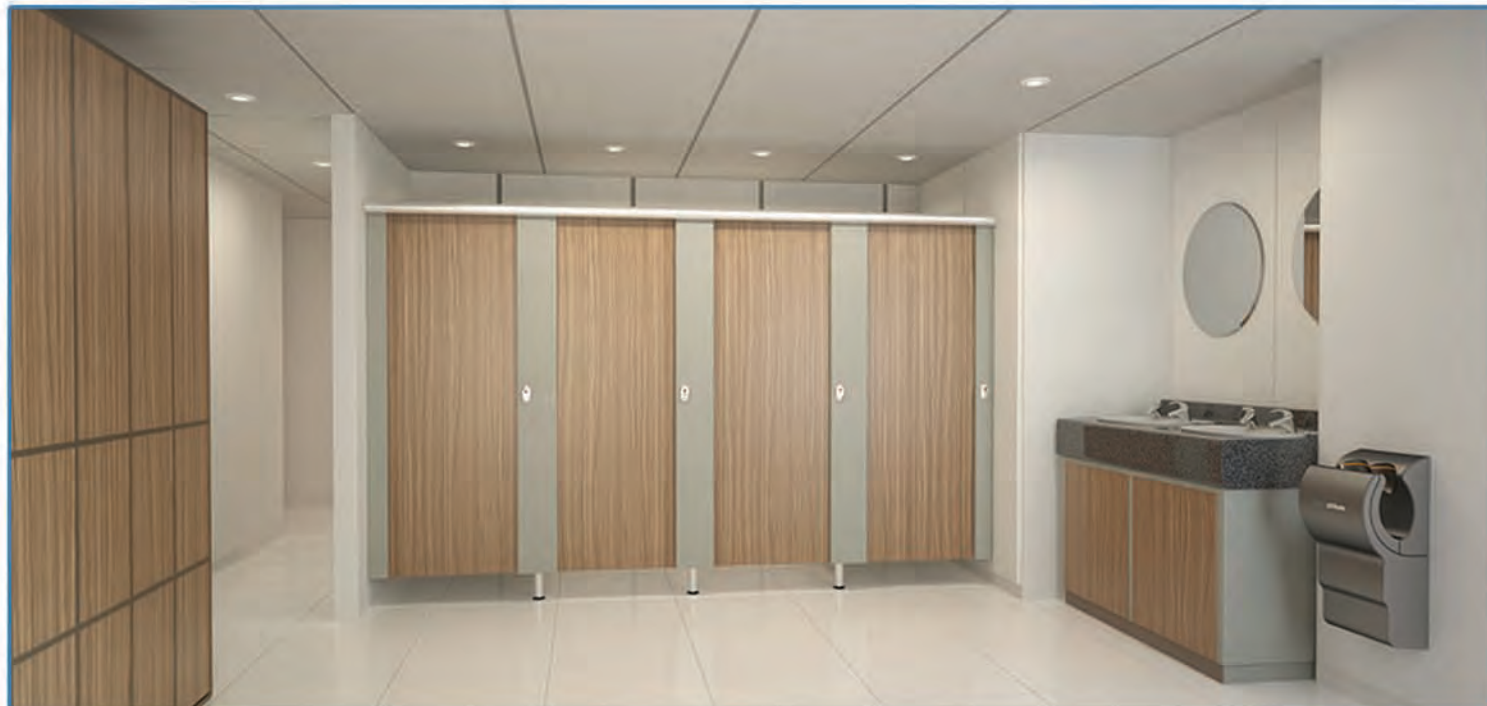

Specification: T1

Overall Cubicle Height: 1950mm

Overall Cubicle Depth: 1530-1830mm

Floor Clearance: 150mm

Doors: 20mm HPL postformed vertical edges

Dividers: 20mm HPL

Pilasters: 30mm HPL double sided postformed

Colours: Refer to the Kingfisher Washroom Collection Chart for laminate choice colours.

Applications: General commercial projects including schools, colleges, hospitals and other business developments.

Utility: Dry use environments.

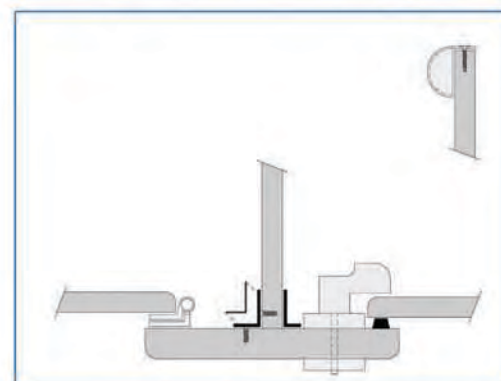

FINESSE CUBICLE

The finesse cubicle is a clean, contemporary lined system designed for high volume public usage areas. Its key features combine the use of stainless steel & aluminium ironmongery throughout with compact grade laminate as a core panel material.

The headrail used on this system is an attractive gullwing design which encapsulates the pilasters offering maximum rigidity to each cubicle.



Specification: T2

Overall Cubicle Height: 1980mm

Overall Cubicle Depth: 1530-1830mm

Floor Clearance: 150mm

Doors: 12mm CGL compact grade laminate, all exposed edges polished and radiused.

Dividers: 12mm CGL compact grade laminate

Pilasters: 12mm CGL all exposed edges polished and radiused.

Colours: Refer to the Kingfisher Washroom Collection Chart for laminate choice colours.

Applications: Industrial and public environments including hotels, leisure centres, sports stadiums, schools and pharmaceutical companies.

Utility: Wet and dry use environments.

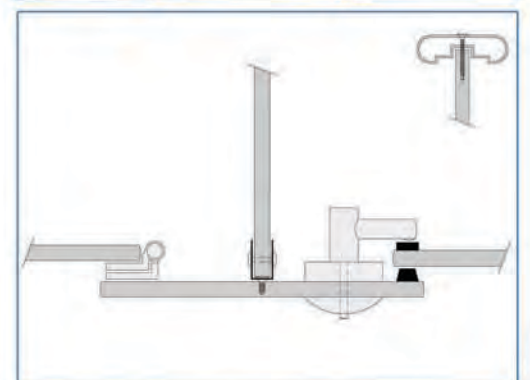
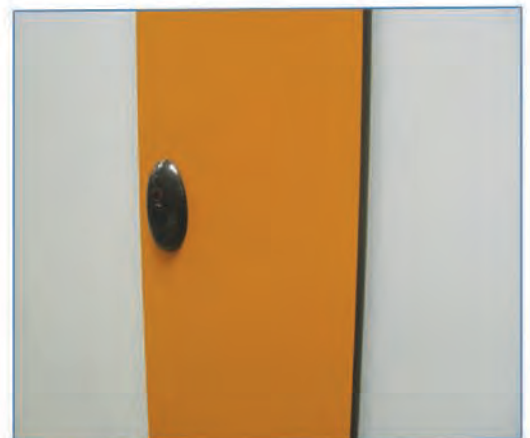

MONDIALE CUBICLE

Mondiale is a clean, flush faced cubicle design. Highlights of this model are the rebated doors and pilasters which strike an impressive vertical detail between each cubicle.

The overlapping of these two panels reduces the evidence of any visual ironmongery with the exception of the pilaster fascia indicator bolt. The supporting cubicle leg is stepped back to create a floating impression with a minimalist headrail design maximizing the cubicle's visual appearance.



Specification: T3

Overall Cubicle Height:	1980mm
Floor to Ceiling:	1980mm + FTC
Overall Cubicle Depth:	1530 - 1830mm
Floor Clearance:	50 - 150mm
Door Height Options:	1810 - 1910mm
Doors:	12mm CGL polished and radiused
Dividers:	20mm HPL 12mm CGL polished and radiused
Pilasters:	12 - 20mm CGL polished and radiused
Colours:	Refer to the Kingfisher Washroom Collection Chart for laminate choice colours.
Applications:	General use, executive offices, hotels and business developments.
Utility:	Wet and dry use environments.

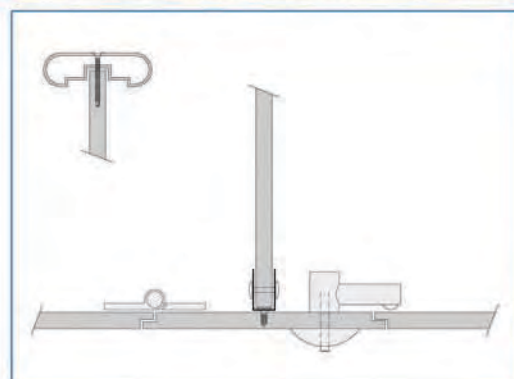
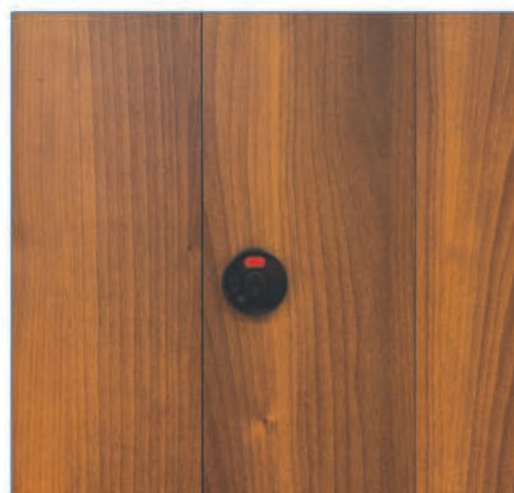

INTERNATIONAL CUBICLE

Singular in its design, the International cubicle eliminates the traditional pilaster faced concept. This creates maximum internal space between each divider. Kingfisher offer a bullnosed face on the high pressure laminate or a polished and radiused finish on the compact grade core creating a safe, slimline appearance.

An attractive, stainless steel bar runs through the top of each divider traveling parallel with each door, stabilising the cubicle.



Specification:

Overall Cubicle Height: 2050mm - 2150mm

Overall Cubicle Depth: 1750 - 1800mm

Floor Clearance: 100 - 150mm

Doors: 20mm HPL postformed vertical edges
12mm CGL polished and radiused

Dividers: 20mm HPL
12mm CGL polished and radiused

Pilasters: 25mm Bullnosed front faced on
HPL / CGL Divider

12mm CGL polished and radiused

Colours: Refer to the Kingfisher Washroom
Collection Chart for laminate choice colours.

Applications: High end luxury product for Public Transport
Areas, Inc Airports, Bus & Rail Stations.

Utility: Wet and dry use environments.

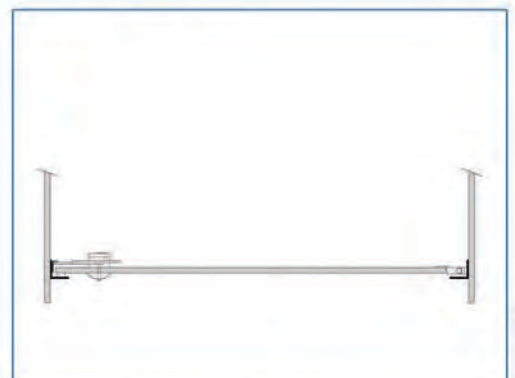
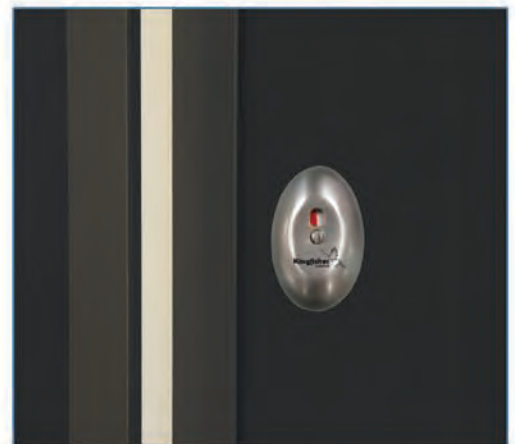

ORBIT CUBICLE

The Orbit cubicle is a floor to ceiling designed system with its priorities based on privacy and aesthetics.

It incorporates an eye catching curved aluminium pilaster, which can be lowered to floor level if required and continued to full ceiling height to maximise security and privacy for users. Pilasters are available in a variety of finishes including powder coating and anodized treatments.



Specification: T5

Overall Cubicle Height: 2050mm

Floor to Ceiling: 2050mm + FTC

Overall Cubicle Depth: 1550mm – 1850mm

Floor Clearance: 50 - 150mm

Doors: 20mm HPL postformed vertical edges
12mm CGL polished and radiused
10mm Glass

Dividers: 20mm HPL
12mm CGL polished and radiused

Pilasters: Aluminium elliptical shaped pilaster

Colours: Refer to the Kingfisher Washroom Collection Chart for laminate choice colours.

Applications: High end luxury product with maximum privacy for executive offices, hotels & business developments

Utility: Wet and dry use environments.

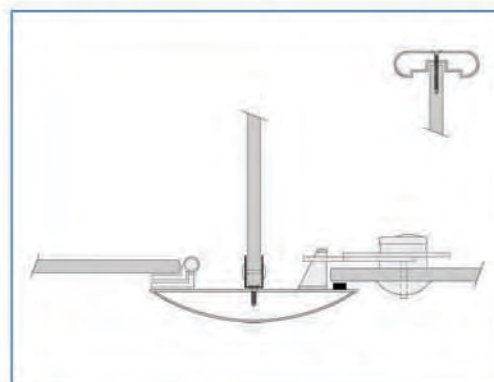

ATLAS CUBICLE

The Atlas cubicle is unique to Kingfisher, the only manufacturer to produce a bow shaped door, setting this system apart from other washroom models. Its stylish appearance is complemented by stainless steel pilasters and matching convex shaped vanity panels where required.

An exclusive range of ironmongery includes a pilaster lock for gentle and easy operation, a billet shaped cubicle leg for strength and rigidity and finally a gullwing shaped headrail for premium appearance.



Specification: T6

Overall Cubicle Height: 1980mm – full ceiling height

Overall Cubicle Depth: 1500-1800mm

Floor Clearance: 150mm

Doors: 16.5mm HPL to Bow Profile,
Varnished & Sealed
10mm Glass

Dividers: 20mm HPL
12mm CGL polished and radiused

Pilasters: 30mm Profilled Stainless Steel

Colours: Refer to the Kingfisher Washroom
Collection chart for laminate choice
colours.

Applications: General use including executive offices,
public areas, hotels and business developments.

Utility: Wet and dry use environments.

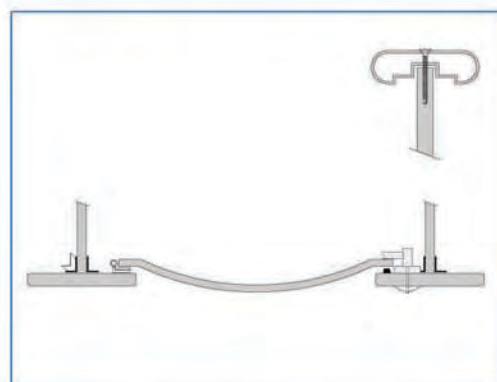

TIGER CUB CUBICLE

The Tiger Cub cubicle is a bright, fun and safe system for children ranging from 3 to 12 years of age.

The cubicle partitions and doors are shaped to graduate in height according to age category, matching the supervisory requirements of staff, to the privacy needs of the child.



Specification: T7

Overall Cubicle Height:	1950mm
Overall Cubicle Depth:	1530mm - 1830mm
Floor Clearance:	150mm
Door Height Options:	1150-1350-1550mm above ffl
Doors:	20mm HPL postformed vertical edges 12mm CGL polished and radiused
Dividers:	20mm HPL 12mm CGL polished and radiused
Pilasters:	30mm HPL double sided postformed 12mm CGL polished and radiused
Colours:	Refer to the Kingfisher Washroom Collection Chart for laminate choice colours. Screen Printing in HPL only
Applications:	Schools and nurseries.
Utility:	Wet and dry room environments.



Alphabet ID Number A871



Numbers & Sums ID Number 1871



Engines ID Number EO43



Fish ID Number F756

For fun and education we have four screen printing images which can be incorporated on our cubicle doors, service wall panels and vanity enclosure panels. **For more information contact info@postformed.com**

METRO BESPOKE CUBICLE

Metro bespoke is an exclusive opportunity for every client, architect and interior designer to replicate live pictorial images into the washroom environment. Metro adds the wow factor creating maximum impact for clients' who want to make a personal statement.

Note: available in HPL only. The manufacturer recommends Metro Bespoke is used as a front fascia panel and uses a complementary colour from our wash room collection to the back of each individual panel. **For more information contact info@postformed.com**



Colours: for complimentary colours, please refer to the Kingfisher Collection Washroom Collection Chart for Metro bespoke washrooms.

Applications:

General use, Schools / Nursery, Hotel & Leisure & Commercial Developments.

Utility:

Dry use environments



Alphabet ID Number A871

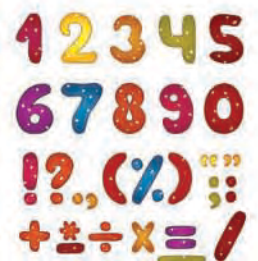

Numbers & Sums ID Number 1871



Engines ID Number EO43



Fish ID Number F756

IRONMONGERY

HEADRAILS



Gullwing Silver / Black



D Profile – Silver / Black



Orbit Profile - Silver / Black



Lock Fascia



Lever Lock



Indicator Bolt



Pedestal Leg L1



Pedestal Leg L2



Cubicle Hinge



Coat Hook C1



Coat Hook C2

All kingfisher cubicles benefit from a stylish choice collection of ironmongery to complement each cubicle design and application. Strength and rigidity are key factors we consider when designing our cubicles and our premium components are tested to ensure longevity and ease of use.

Profiled headrails encapsulate the pilasters for maximum strength and our pilaster mounted lever locks provide safety and security through its gentle 90 degree movement.

SERVICE WALLS



SERVICE WALLS



Our Defender Service Walls provide a solution to designers and architects to panel out interior walls decoratively, with a range of surface material finishes. Each frame is manufactured to room design identifying ceiling heights, plumbing services and flooring details.

Pre-plumbing is also catered for and a selection of white sanitary goods can be factory fitted prior to site installation. Kingfisher offer a flexible solution, with excellent structure stability for WC toilets, urinals and wash basin assemblies.

Defender Service Wall Applications

- Commercial
- Industrial
- Healthcare
- Education
- Leisure

Advantages of the Defender Service Walls.

- Flexibility of design to conceal mechanical services
- Versatility in the installation of Sanitary Ware
- Accessibility to service ducts via gravity or hinged panel access
- All access panels can include locking mechanisms
- Suitable for wet and dry environments

SERVICE WALLS

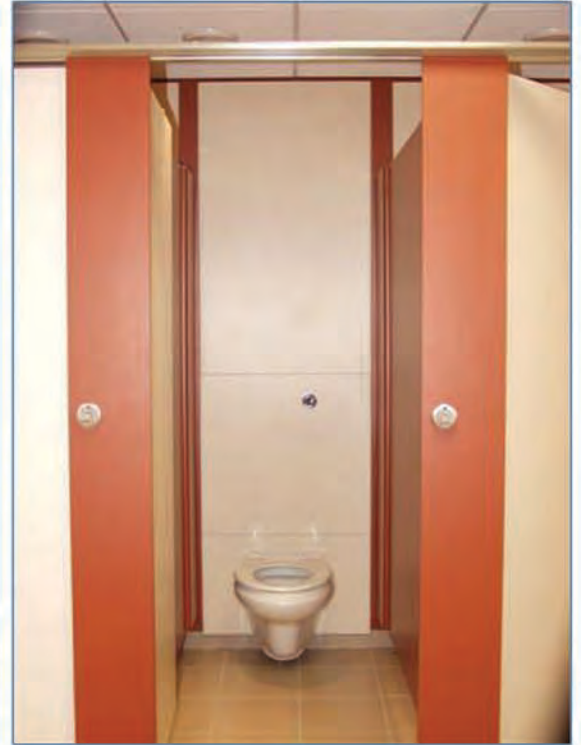

Service Wall Panel Specification

HPL: High Pressure Laminate

Bonded to 18 mm moisture resistant core board with balancing laminate to rear .

Vertical post formed panels, with laminate or PVC edging.

CGL: Compact Grade Laminate

12 mm compact grade laminate with exposed edges polished and radiused.

Framing Constructions

All service wall frames are factory constructed using treated timber or powder coated Aluminium. Timber frames are laminated with a selected colour and Aluminium frames are finished in a powder coated colour .

Panel Suspension is catered for by using steel gravity fixings, push and pull Keku's and all hinged panels have 170 ° hinges with privacy locks for security.

Colours

Refer to the Kingfisher Washroom

Collection Chart for laminate choice colours Page 49

Panel Specification see page 42 - 43

Technical Drawings page 46



VANITY UNITS



WASHROOM VANITY UNITS

Our Vanity Units and coving tops are manufactured to accommodate the wide range of ceramic shaped wash basins available today. At Kingfisher all vanity tops are complemented by a laminated substructure of designs including lockable press storage units, wall hung bracketry systems and removable access panels to services.



Vanity Unit Applications

- Commercial
- Hospital
- Education
- Laboratory

Vanity Top Specification

High Pressure Laminate is bonded to an 18mm moisture resistant core board with a balancer laminate to the underside. Our manufacturing techniques create homogenous up stands and front aprons in varying heights and depths. This design accepts inset wash basins and is a proven, practical and economical design for any vanity top.

WASHROOM VANITY UNITS



Solid Surfacing is an innovative and desirable material that will enhance the appearance of any washroom vanity.

It can be shaped to any architectural design, including a wide range of acrylic shaped solid surface basins.

Ceramic shaped bowls can be adopted perfectly in an under mount fashion or plant on design.

This material is smooth and pleasant to touch and is finished with seamless waterproof joints.

Compact Grade Laminate

Available in 12mm and 18mm thickness. A waterproof and highly durable material. It can accommodate inset and under mount stainless steel sinks with fabricated up stands and front aprons.

Colours

Refer to the Kingfisher Washroom Collection

Chart for laminate choice colours Page 49

Technical Drawings page 47

For solid surfacing application colours email: info@postformed.com



LAMINATED FURNITURE



LAMINATED FURNITURE

Our laminate furniture is tailored made from supreme surface materials for scientific and hospital laboratory environments. These materials offer advanced chemical resistance where hygiene cleanliness and durability are paramount.



Laminated Furniture Applications for :

- Hospital
- Commercial
- Education
- Laboratory

Worktop Specification.

High pressure laminate bonded to moisture resistant core board, coving upstand to rear with a post formed leading edge to front nosing and balancer laminate to underside.

Chemtop 2 & Compact grade laminate are complimentary material surfaces which can incorporate laboratory style under mount sinks.

LAMINATED FURNITURE



Floor & Wall units are manufactured from 20mm thick moisture resistant core board with access points to concealed services. Doors have vertical post formed edges with 170 degree hinges, lockable key mechanism and specified handles.

Units can be constructed entirely from (CGL) compact grade laminate.

Contact sales for more information.

Colours

Refer to the Kingfisher Washroom Collection Chart for laminate choice colours page 49

For panel specification see page 42 - 43

HEALTHCARE

PAGE 25

USES & APPLICATIONS

PAGES 26-28

MEDICO UNIT ASSEMBLIES

PAGES 29-31

BOXED OUT UNITS

PAGES 32-34

STAINLESS STEEL

PAGE 35

SANITARY WARE

PAGES 36-38

BRASSWARE





Medico Unit Utility

Our Medico units are designed and manufactured for clinical and non clinical areas within hospital environments.

Popular refurbishment works are also catered for including day care medical centres and community nursing units.

Features and Benefits of Kingfisher Medco Units

- Compliance to DO8 and HTM regulations
- Aluminium framed construction
Rigid and durable (no timber content)
- Infection control
Modern manufacturing processes produce tight engineered tolerances between panel assemblies.
- A comprehensive range of sanitary ware and brassware assemblies is available on our units.
- Delivery
Units are made to order, delivered preassembled, tested and ready to install .



HEALTHCARE MEDICO UNIT ASSEMBLIES



CLINICAL UTILITY

This boxed out unit incorporates a **clinical wash hand basin** and TMV3 thermostatic sequential mixer. The unit is custom manufactured to project out adjacent to solid or partition walls and integrate into suspended or solid ceilings, whilst encasing all services and waste pipes to the rear of the panelling.

TMV3 APPROVED THERMOSTATIC DO8 TAP
HTM - DH REF LBHM TBH2A

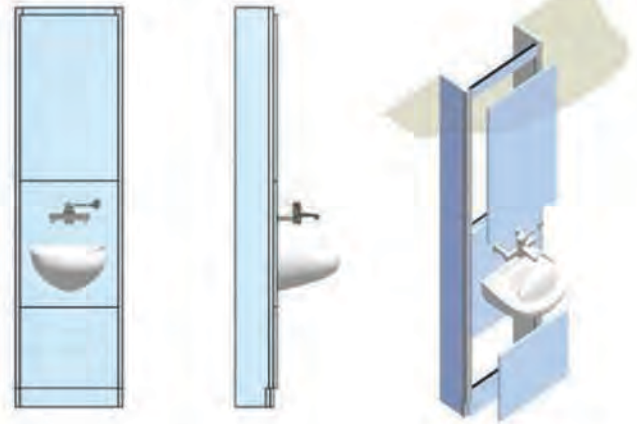

CAREMIX THERMOSTATIC TAPS

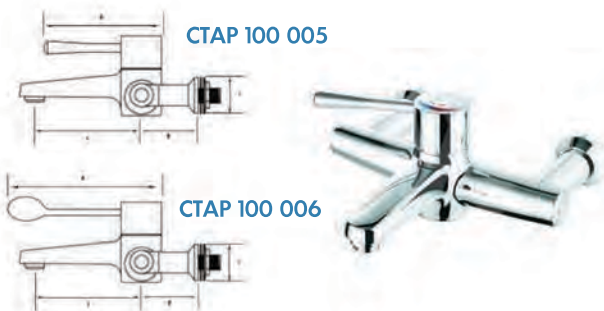

The Caremix® T3 is a sequential D08 approved thermostatic tap typically used in areas with a panel system where the tap is mounted on a wall or panel with a void behind which carries the service pipework as is common in many commercial sites. The Caremix® T3 tap is perfectly suited for high risk environments like hospitals or nursing homes to prevent vulnerable people from being scalded by hot water. The tap is designed for ease of operation and installation and incorporates isolation, filtration, check valves and flow regulators in the design of the body.

Part Code	A	B	C
CTAP 100 005	155	105	56
CTAP 100 006	237	105	56

SOLA SPECTRUM 500

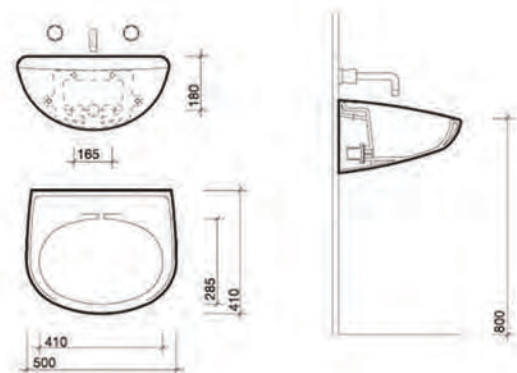

- * Hospital Pattern Basin
- * Integral back outlet
- * No plug, hole or overflow
- * Panel mounted basin

Colour's: Page 49/50
 Panel Spec: Page 42/43
 Infra Red Sensor: Page 36

Pre plumbed factory tested
 Easy installation
 Hinged lockable access panels
 Made to order

HEALTHCARE MEDICO UNIT ASSEMBLIES



NON CLINICAL UTILITY

This boxed out unit incorporates a **non clinical wash hand basin** and lever operated thermostatic mixer tap for use on single tap hole basins. The unit is custom manufactured to project out adjacent to solid or partition walls and integrate into suspended or solid ceilings while encasing all services and waste pipes to the rear of the paneling.

TMV3 APPROVED THERMOSTATIC DO8 TAP
HTM - DH REF GMLBGL TP6

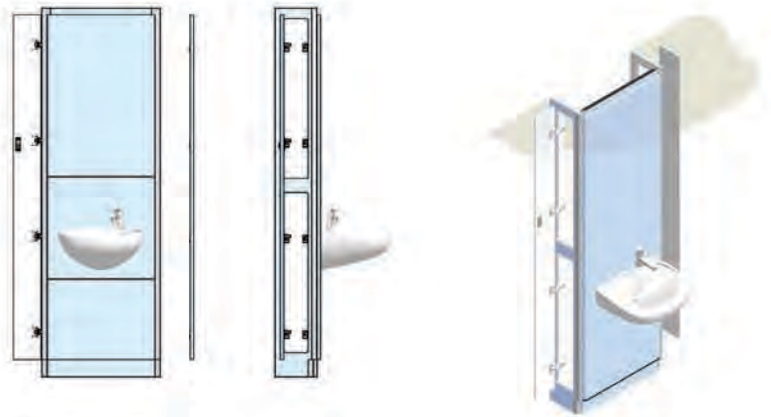

CAREMIX THERMOSTATIC TAPS

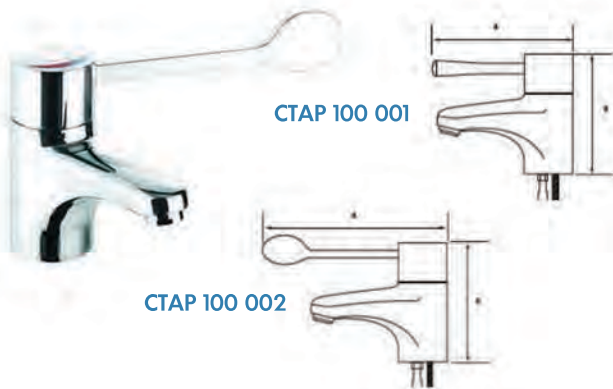

The Caremix® S3 a sequential D08 approved thermostatic tap for use on single hole basins in high risk environments like hospitals or nursing homes to prevent vulnerable people from being scalded by hot water. The tap is designed for ease of operation and installation and is supplied complete with combination valves incorporating isolation, filtration, check valves and flow regulators.

SOLA MEDICAL 500 / 600

2 tap hole 25mm - 1 tap basin 32mm

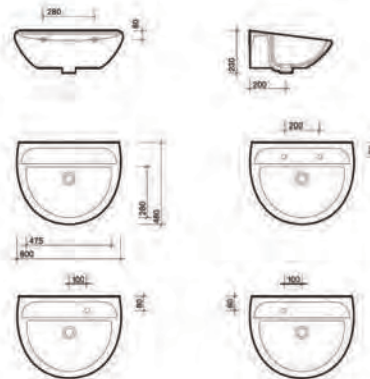

- * Non clinical hospital pattern basin
- * No overflow, no chainstay
- * Panel mounted basin
- * Available in 500-600mm width
- * For 2 tap hole basins, temperature reducer is required to prevent scalding from hot water supply.

Colour's: [Page 49/50](#)
 Panel Spec: [Page 42/43](#)

Pre plumbed factory tested
 Easy installation
 Hinged lockable access panels
 Made to order

Part Code	A	B	C
CTAP 100 001	155	148	55
CTAP 100 002	237	148	55

HEALTHCARE MEDICO UNIT ASSEMBLIES



NON CLINICAL UTILITY

This boxed out unit incorporates a **non clinical hand rinse basin** and lever operated thermostatic mixer tap for use on single tap hole basins. The unit is custom manufactured to project out adjacent to solid or partition walls and integrate into suspended ceilings while encasing all services and waste pipes to the rear of the panelling.

TMV3 APPROVED THERMOSTATIC DO8 TAP
HTM - DH REF LBGS TP6

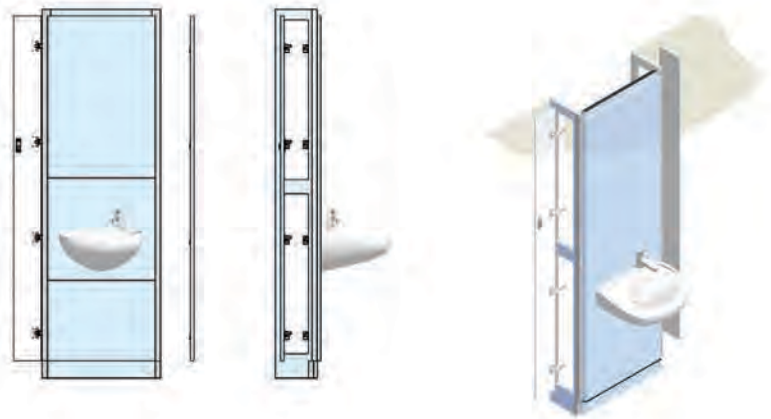

CAREMIX THERMOSTATIC TAPS

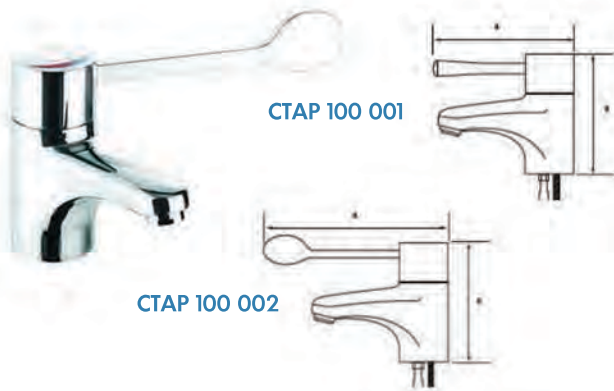

The Caremix® S3 is a sequential D08 approved thermostatic tap for use on single hole basins in high risk environments like hospitals or nursing homes to prevent vulnerable people from being scalded by hot water. The tap is designed for ease of operation and installation and is supplied complete with combination valves incorporating isolation, filtration, check valves and flow regulators.

Part Code	A	B	C
CTAP 100 001	155	148	55
CTAP 100 002	237	148	55

SOLA MEDICAL 400

2 tap hole 25mm - 1 tap basin 32mm

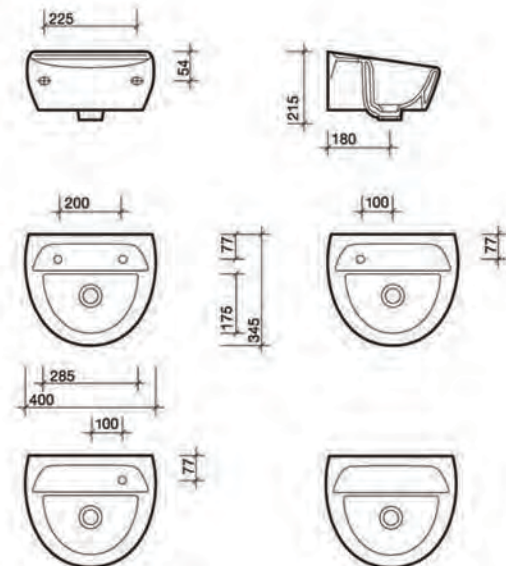

- * Non clinical hospital pattern basin
- * No overflow, no chainstay
- * Panel mounted basin

Colour's: Page 49/50
 Panel Spec: Page 42/43

Pre plumbed factory tested
 Easy installation
 Hinged lockable access panels
 Made to order

Model Type SP1

This boxed out unit is custom manufactured to project out adjacent to solid or partition walls and integrate into suspended or solid ceilings while encasing all services and waste pipes to the rear of the panelling.

Design: E Type aluminium frame with specified gravity fitting panels.

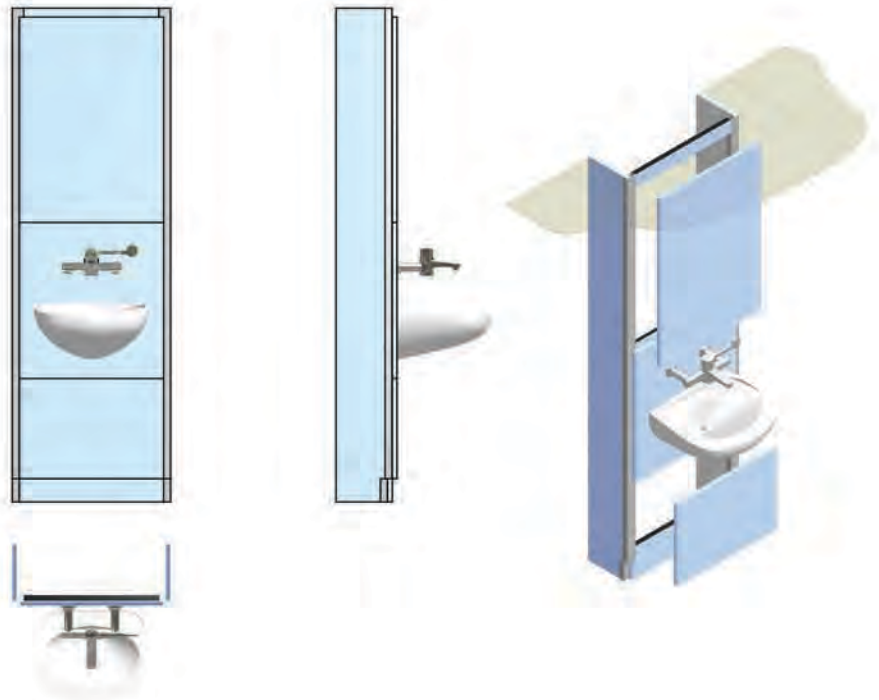

Model Type SP2

The side entry model is custom manufactured to create an entire flush finish on the front panel fascia. Service access is only carried out via a hinged door or side gravity panel handed according to room layout.

Design: E Type aluminium frame with specified front and side entry panels.

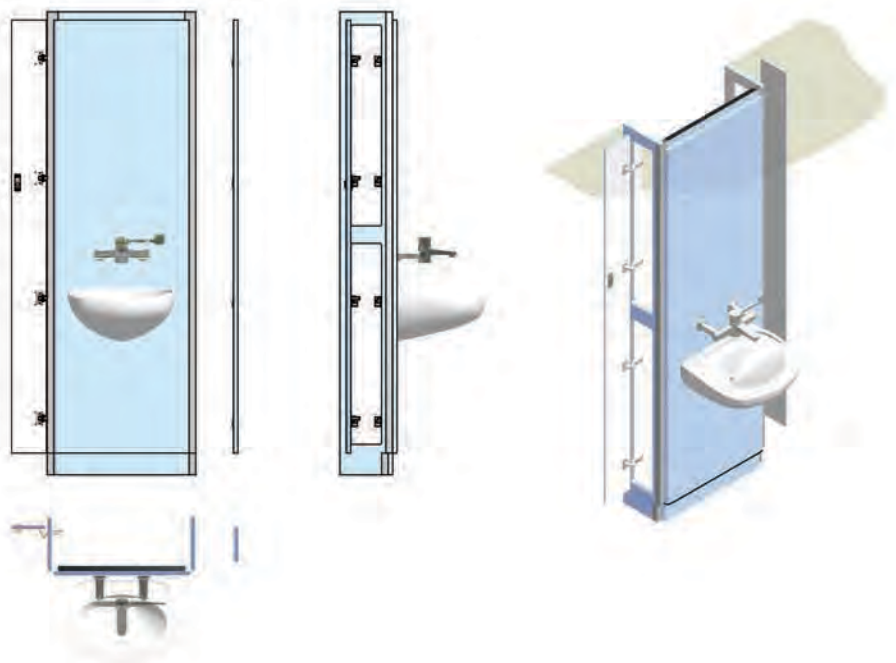

For Sanitary Ware Assemblies See Page 35
For Brass Ware Assemblies See Page 36-38

Model Type SP3

The slope top model is custom manufactured to an overall specific height, adjacent to solid or partition walls where services and wastes are required to enter and exit the rear of the panelling.

Design: E Type aluminium frame with specified gravity fitting or side entry access panel.

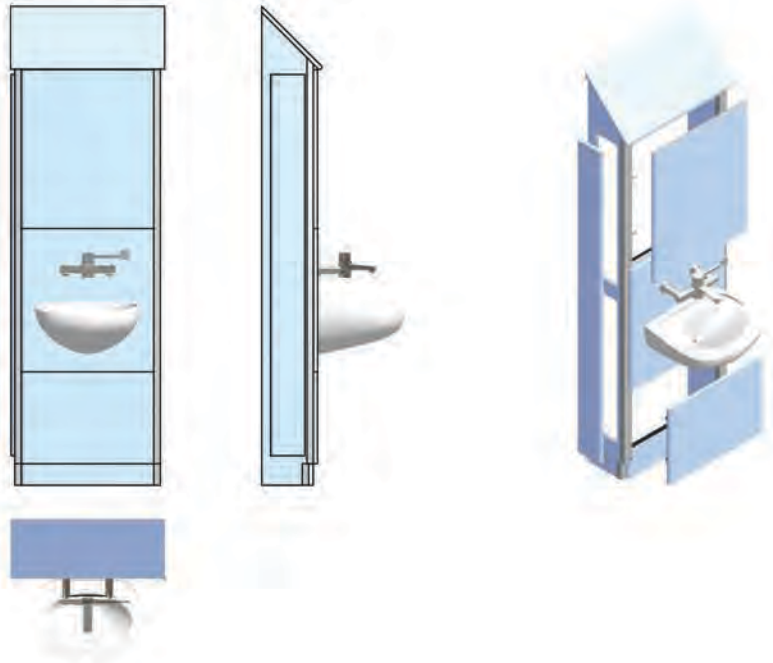

Model Type SP4

The aperture model is manufactured to flush fit into a created opening in the partition wall with all services concealed to the rear of the panel.

Design: Aluminium frame with specified gravity fitting panels.

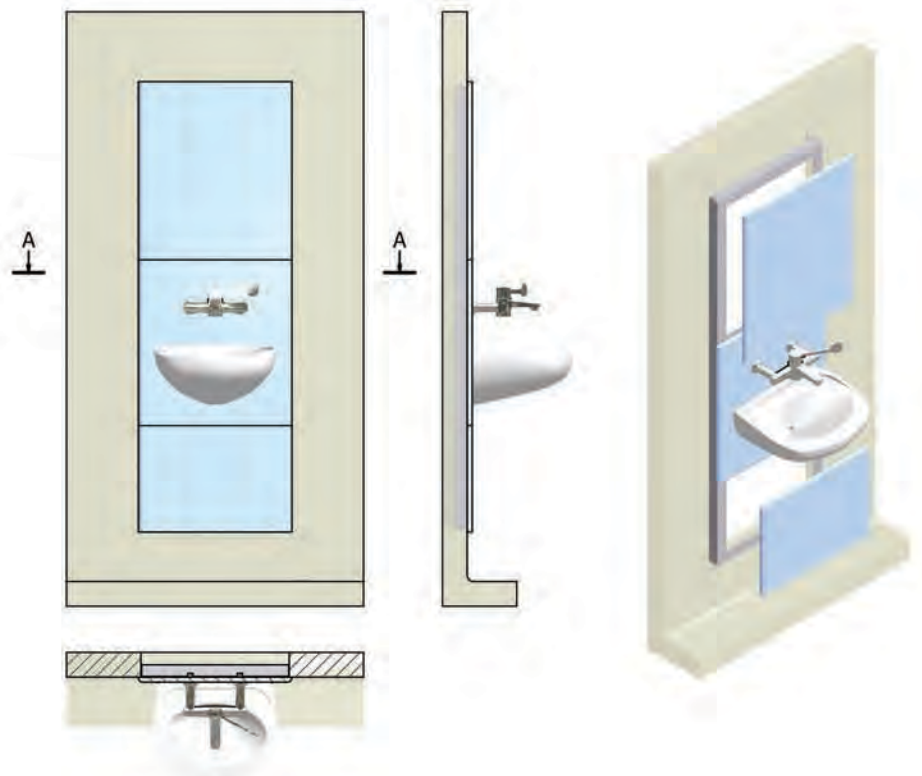

For Sanitary Ware Assemblies See Page 35

For Brass Ware Assemblies See Page 36-38

Model Type SP5

- This boxed out unit is custom manufactured to project out adjacent to solid or partition walls and integrate into suspended or solid ceilings.
- This design of unit is configured to accept a range of healthcare stainless steel surgeon sink and scrub up troughs.
- Design: E Type aluminium frame with specified gravity fitting panels.

For Stainless Steel Sinks See Page 32-34
For Brass Ware Assemblies See Page 36-38



Framing Specifications for Boxed out units:

SP1 - SP5

- Key construction on the E Type frame consists of E profile section in 3mm gauge aluminium finished in a grey powder coating.
- Incorporated rail support system for sanitary ware uses Compact Grade Laminate thus removing any timber content.
- Modern manufacturing methods coupled with key materials make the E type a robust unit with a high level of rigidity. These benefits promote optimum hygiene standards with excellent infection control capabilities.
- Panel suspension is catered for by using secret fixings with tight engineered tolerances. Positive Shadow Gaps can be created between panels upon request.
- Top Access panels can be hinged and locked upon request.

A comprehensive range of surface finishes are available on our Medico Units,

These include:

High Pressure Laminate

Compact Grade Laminate

Solid Surfacing

STAINLESS STEEL

FOR BOXED OUT UNIT ASSEMBLIES

OUR REFERENCE MODEL **SP5**

Ibiza Inset hospital sinktops



Ibiza inset hospital sinktops are widely used in hospitals, public & private clinics, surgeries, nursing homes and accident units.

Ibiza sinktops have polished bowls measuring 432mm x 356mm, 180mm deep (0.92mm thickness) and drainers (0.92mm thickness) and include sound deadening pads, integral earth tag to BS 4190 and fixing clips.

Tapholes at 180mm or 200mm centres. Supplied with overflow as standard

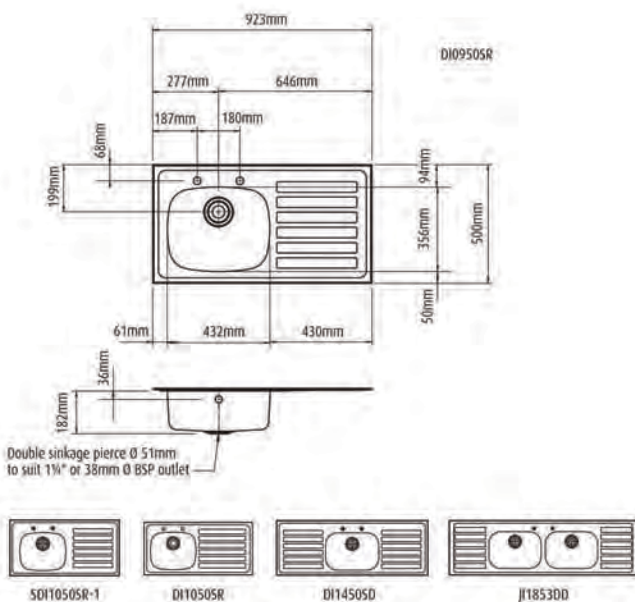

Product	Code
---------	------

Single bowl, single drainer

923mm x 500mm LHD	D10950SL
923mm x 500mm RHD	D10950SR
1028mm x 500mm LHD	SD1050SL-10
1028mm x 500mm RHD	SD1050SR-10
1028mm x 500mm sinktop, left hand drainer	DL1050SL
As above but right hand drainer	DL1050SR

Single bowl, double drainer

1364mm x 500mm sinktop	DL1450SD
------------------------	----------

Twin bowl, double drainer

1828mm x 533mm sinktop	JL1853DD
------------------------	----------

Twin bowls, single drainer

1364mm x 500mm sinktop	DL1450DL
As above but right hand drainer	DL1450DR

Options

Please note SD1050 models feature a 508mm x 356mm x 250mm deep bowl.

Waste fittings

1 1/2" BSP waste no overflow	WK0075
1 1/2" BSP waste with overflow	WK0187

STAINLESS STEEL

Sark

HTM64 healthcare sink



Versatile single or double bowl sinks without overflow that can be wall or panel mounted. Bowls measure 508mm x 356mm. Supplied on cantilever brackets with sound deadening pads, rimmed edges with 50mm turn-down.

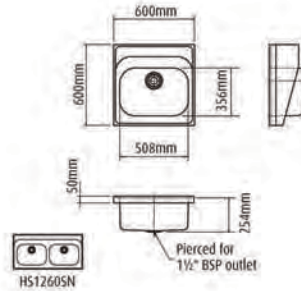

Product	Code
---------	------

Single bowl
600mm x 600mm **HS0660SN**

Double bowl
1200mm x 600mm **HS1260DN**

Options

Overflow, piercing available on request.
Tapholes at 180mm or 200mm centres.
Stainless steel legs **SHLG0600**

FOR BOXED OUT UNIT ASSEMBLIES
OUR REFERENCE MODEL **SP5**



Fiji

HTM64 slop hopper



Hospital pattern wall or panel mounted, combined slop hopper, sink & drainer which conforms to HTM64(DU-H). Overall size 1600mm x 600mm with polished bowl 533mm x 381mm, 200mm deep. Supplied with sound deadening pads and earth tag

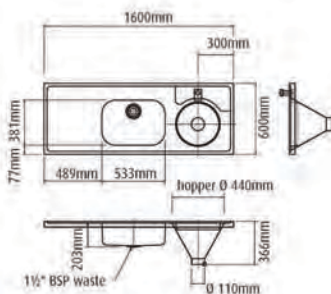

Product	Code
---------	------

Fiji combined slop hopper sink & drainer

Back entry 110mm diameter 1600mm x 600mm x 366mm **HC1660B110L/R**
Top entry 110mm diameter 1600mm x 600mm x 366mm **HC1660T110L/R**
Cantilever brackets **SHB0600L/R**

Options

Stainless steel legs **SHLG0600**
Cisterns, connecting pipes & brackets as Java
Waste, traps and 75mm outlet available on request.
Concealed high level plastic cistern with lever **SAN1002**

With P trap

Polypropylene P Trap **HT110(P)**
Stainless Steel P Trap **HT110P**

With S trap

Polypropylene S Trap **HT110(S)**
Stainless Steel S Trap **HT110S**

STAINLESS STEEL

FOR BOXED OUT UNIT ASSEMBLIES

OUR REFERENCE MODEL **SP5**

Trinidad HTM64 scrub-up trough



Surgeons' scrub-up trough to HTM64 manufactured in high quality 1.5m 304 grade stainless steel. Supplied with sound deadening pads and joggle strip for wall fixing, incorporating a fully welded 1 1/2" BSP waste connection.

Sensor Taps

The surgeons' scrub-up wall mounted sensor taps are specifically designed for surgeon's scrub-up areas. The taps have a longer reach, incorporating a special chip providing longer sensing range and run out time, which ensures that whilst the surgeons wash their hands and forearms the taps continue to run. The 20 second run out time ensures the trough is adequately rinsed after scrubbing up. Taps are available in 1,2 & 3 station kits

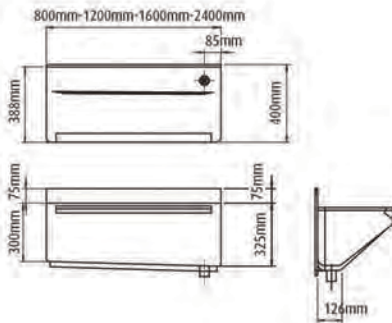

Product	Code
Scrub-up trough	
800mm	HSUT0800L/R
1200mm	HSUT1200L/R
1600mm	HSUT1600L/R
2400mm	HSUT2400L/R

Options

Left or right waste outlet
Lengths to suit requirements.
Trap cover

HSHROUD

Sensor Taps

Single Station wall mounted surgeons' scrub-up sensor tap	TP1068
2 Station wall mounted surgeons' scrub-up sensor tap	TP1069
3 Station wall mounted surgeons' scrub-up sensor tap	TP1070
Single Station wall mounted sensor tap	TP1081
2 Station wall mounted sensor tap	TP1035
3 Station wall mounted sensor tap	TP1036

SANITARYWARE

SOLA SPECTRUM 500



Hospital pattern basin integral back outlet
No plug, tap hole or overflow
Panel mounted basin
DH REF: LB HM
500mm width 410mm depth
Use Caremix®T3 tap

SOLA MEDICAL 400



General hospital pattern basin
No overflow, no chainstay
LH tap hole, RH tap hole, 2 tap holes
DH REF: LBGS
400mm width 345mm depth
Use Caremix®S3/H3 tap

SOLA MEDICAL 500



General hospital pattern basin
No overflow, no chainstay
LH tap hole, RH tap hole, 2 tap holes
DH REF: LB GM/ LB GL
500mm width 400mm depth
Use Caremix®S3-H3 tap

SOLA RIMLESS WALL HUNG WC



Rimless pan for suspended back to wall toilet accommodation
Seat ring-white (WH), blue (BE) or Grey (GY)
Fully ambient and ambulant disabled users
Shrouded design, no dirt traps

AVALON RIMLESS BTW



Rimless back to wall pan
Set ring white (WH), blue (BE)
Fully shrouded design
Doc M compliant
Suitable for less abled

SPECTRUM URINAL



Concealed flush/waste
Panel mounted (IPS)
HTM 64 Code URH
Healthcare
Commercial
Education

DOC.M RIMLESS BACK-TO-WALL PACK



Disabled toilet accommodation to public areas
Rimless design
Included associated ironmongery

REFRESH 550 COUNTERTOP



Inset basin for vanity counter tops
Dims 510mm x 420mm oval
560mm x 485mm oval

ARIA CENTRIC UNDER COUNTERTOP



Under counter fitment only
Solid surfacing application
Dims 380mm dim round
460mm x 370mm oval

BRASSWARE

CAREMIX®T3 - SEQUENTIAL TMV3 THERMOSTATIC TAP

A DO8 approved thermostatic tap for use on panelling systems in healthcare environments.

Features & Benefits

For use in high risk environments such as hospitals or nursing homes to prevent vulnerable people from being scalded by hot water.

The tap is designed for ease of operation and installation and incorporates isolation, filtration, check valves and flow regulators in the design of the body.

Standard and extended lever for hospital use, options available.



CTAP 100 005



CTAP 100 006

CAREMIX®IR3 INFRA - RED TEMV3 THERMOSTATIC TAP

A panel mounted TMV3 approved infra-red (IR) thermostatic tap for use in healthcare environments.

Features & Benefits

Hands-free operation prevents cross contamination.

TMV3 approved.

Battery and mains operated versions available.

15mm connections.

Integral isolating valves, filters and flow regulators.



CTAP 100 015 - Mains
CTAP 100 016 - Battery

CAREMIX®H3 - DECK MOUNTED 2 HOLE TM3 THERMOSTATIC TAP

A sequential TMV3 DO8 approved thermostatic tap for use on two hole basins to prevent scalding by hot water in high risk environments such as hospitals.

Features & Benefits

The tap is designed for ease of operation and installation and incorporates isolation, filtration, check valves and flow regulators.

Standard and extended lever for hospital use, options available.



CTAP 100 011



CTAP 100 010

BRASSWARE



CTAP 100 002



CTAP 100 001

CAREMIX®S3 - MONOBLOC TMV3 THERMOSTATIC TAP

A sequential TMV3 DO8 approved thermostatic tap for use on single hole basins to prevent scalding in high risk environments such as hospitals.

Features & Benefits

The tap is designed for ease of operation and installation and is supplied complete with combination valves incorporating isolation, filtration check valves and flow regulators

Standard and extended lever for hospital use, options available.

SENSELEC®IR BASIN CONTROLS - WALL MOUNTED

A unique range of infrared (IR), electronically controlled wall mounted basin controls.

Features & Benefits

Automatic infrared flow control to save water and energy.
Available as battery or main/6 volt transformer powered options.
User adjustable sensor detection range.
Security lockout feature after 30 seconds of continuous running to prevent vandalism and water wastage.
6 lpm flow regulator is integral with the wall mounted basin control to give economy and control.
Panel mount and cross wall versions available for complete freedom of system design.



SENS 251 125 - Mains



SENS 250 130 - Battery

SENSELEC®TS ANTILIGATURE BASIN SPOUT & SHOWERHEAD

A high quality chrome plated low profile anti-ligature, anti-vandal basin spout and showerhead.

Features & Benefits

Low smooth profile prevents ligature or grab points.
High quality chrome plating for long life.
6 lpm (basin) and 10 lpm (shower) flow regulators fitted for economy and stable flow.
Available in cross wall and panel mounted options.
Complete with unique anti-rotation plate to prevent movement and aid installation.
Removable spray grid for cleaning and disinfection.



SENS 510 120

BRASSWARE

SENSELEC® IR BASIN CONTROLS - SWAN NECK TAP

A unique infrared (IR), electronically controlled deck mounted basin tap to give optimum flow rates even at low pressures.

Features & Benefits

Automatic infrared flow control to save water & energy.

All connections push fit together to save installation time and stop potential damage from soldering.

Available as battery or mains / 6 volt transformed powered options.

User adjustable sensor detection range between 50mm and 250mm.

Security lockout feature after 30 seconds of continuous running to prevent vandalism and water wastage.

6 lpm flow regulator is integral in the aerator to give economy and control.



SENS 251 100

2000 SERIES BASIN TAPS

Features & Benefits

Push operated or lever - handle operation

Self closing.

Self cleaning one piece cartridge.

"S" classification, anti - vandal misuse.

Use refresh 550 countertop.



4000 S SECURITY SERIES BASIN MIXER TAP

Features & Benefits

Push operated or lever - handle operation

Self closing security series time flow.

Hot and cold identification marks.

Use refresh 550 countertop.

4000 S SECURITY SERIES BASIN MIXER TAP

Features & Benefits

Prefabricated shower.

Adjustable anti-scale shower head including flow regulator.

Ergonomic push button.

Timed flow control set to 30 seconds.

Easy & quick to install.

Wall or panel mounted shower.



LOCKERS & BENCHES



DOLPHIN LOCKERS & BENCHES



Dolphin Lockers are manufactured from 12 mm thickness Compact Grade Laminate. This is a highly durable material, ideal for any locker environment.

A comprehensive range of plan sizes and room arrangements can be fabricated to match any washroom design. Dolphin Bench Seating is bespoke manufactured in a rigid framed design, configured to room lay-out to compliment locker design and floor area plan.

Locker & Bench Applications

Dolphin lockers are custom manufactured for Sports Stadia, Schools, Universities, Leisure Centres, Hospitals and Pharmaceutical Industries.

Advantages of Dolphin Locker & Systems

- Flexibility of design & space saving
- Water resistant
- Chemical & graffiti resistant
- Suitable for wet and dry environments
- Extensive choice of sporting colours available

DOLPHIN LOCKERS & BENCHES

Model: G5

100 % compact grade laminate carcass.
Colour – white or grey.
Flash gaps laminated to match door colours.
12mm compact grade door and integrated shelves.
90 degree spring loaded stainless steel hinges and fasteners.
Coat hanger rail and hook.
Comprehensive range of locking mechanisms.
All gable ends covered with compact grade laminate panels
Water and vandal proof.

Model: G7

Premium metal gauge selected to powder coated finish.
Flat top or slanting roof finish.
Integrated hat and coat hook.
90 degree stainless steel hinge and fasteners.
12mm compact grade laminate door, polished radiused edges.
Choice of locking mechanism – chrome vanadium hasp lock, cam lock or coin return.

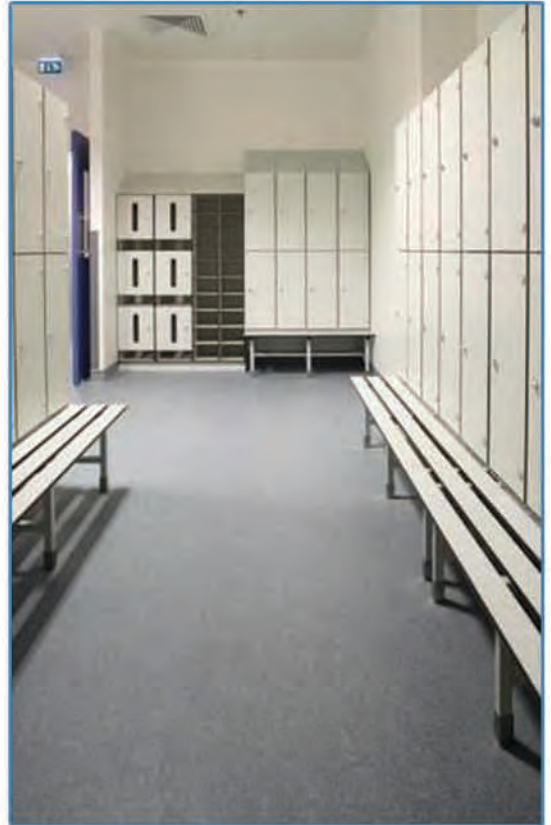

Bench Specifications

- Powder coated box section and Stainless Steel framed units.
- Adjustable feet .
- Seating comes in Compact grade laminate material in wide and narrow sized slot format .

Benching Types

Perimeter Wall Benching
Floor Fixed Benching
Island Unit Benching
Coat Rail options to matching specification

Applications: Education, Industrial, Commercial, Healthcare

Colours

Refer to the Kingfisher Washroom Collection Chart for laminate choice colours page 49
Panel Specification page 42 - 43
Technical Drawings page 48



PANEL PERFORMANCE TABLE

Our Postformed panels are manufactured from 2 layers of high pressure laminate, bonded to an 18mm moisture resistant core board, finished with matching colour on edging or selected PVC trim.

Suitable For Dry Use Environments

HPL High Pressure Laminates

Our Square Edge panels are manufactured from 2 layers of high pressure laminates bonded to an 18mm moisture resistant core board, finished with matching colour on edging or selected PVC trim.

Suitable For Dry Use Environments

CGL Compact Grade Laminate

Compact Laminate 12mm thickness solid core board with resin base having decorative surface finish to both sides. Ideal for areas of high moisture and high humidity. Its usage is for high traffic areas where durability and strong visual appeal is essential. Edges are radiused finished and polished black.

Suitable For Wet & Dry Use Environments

Solid Surfacing

Is an intelligent composition of acrylic, natural minerals and pigments that come together to provide a smooth, non porous and visually seamless surface which meets the highest standards for aesthetics, functionality & hygiene.

Suitable For Wet & Dry Use Environments

Post Forming Panel Laminate or PVC Edging Finish

20mm - 30mm



Square Edge Panel Laminate or PVC Edging finish

20mm - 30mm

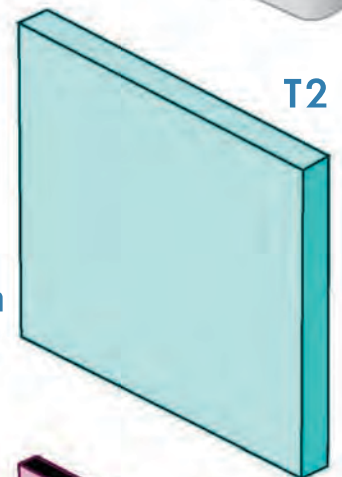

Compact Grade CGL Polished & Radiused Edges

12mm - 18mm

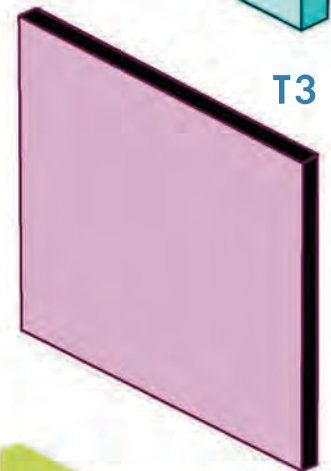

Acrylic Solid Surfacing

12mm



PANEL PERFORMANCE TABLE PROFILES

POSTFORMED PANEL



T1

SQUARE EDGE PANEL



T2

COMPACT GRADE
LAMINATE

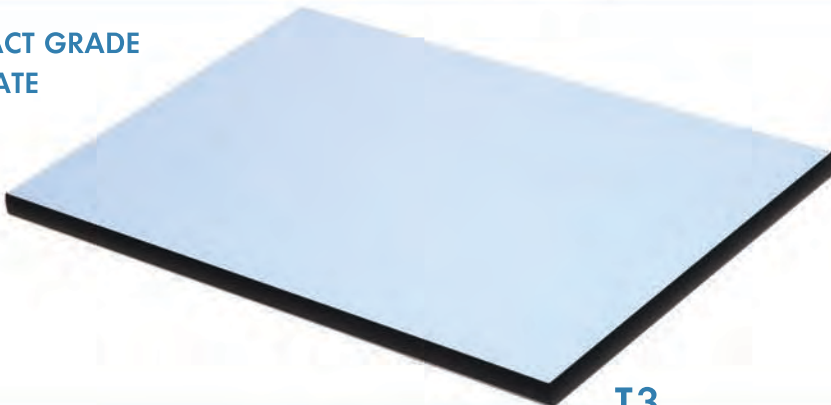

T3

SOLID SURFACING



T4

TECHNICAL DRAWINGS: CUBICLE PLANS

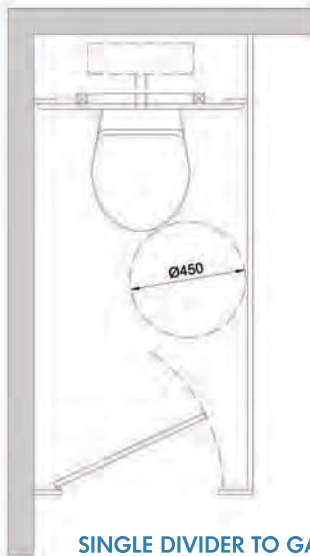

SINGLE DIVIDER TO GABLE WALL

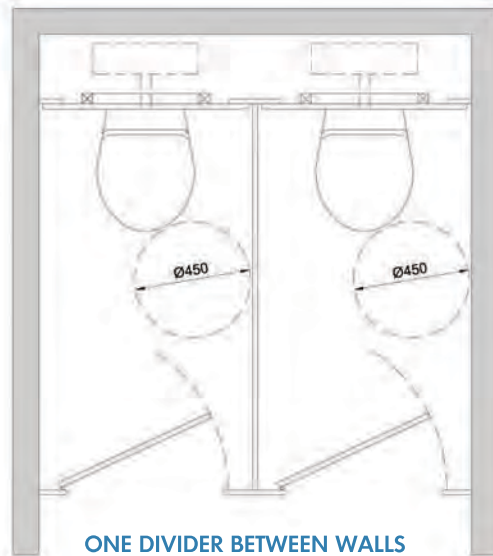

ONE DIVIDER BETWEEN WALLS

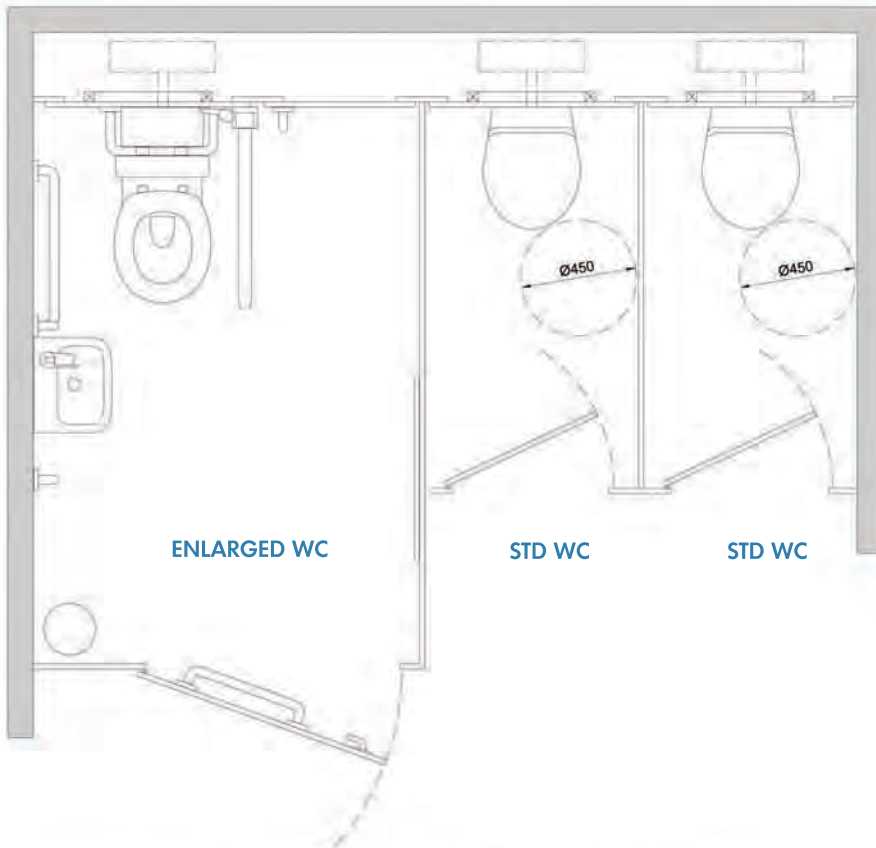

ENLARGED WC

STD WC

STD WC

Cubicle plans and DDA compliance are important factors to consider on any washroom project. Our technical team are happy to discuss your room plan and appropriate sizes to incorporate the conditions set out in the disability discrimination act

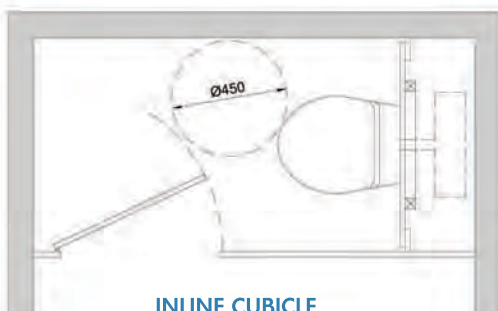

INLINE CUBICLE

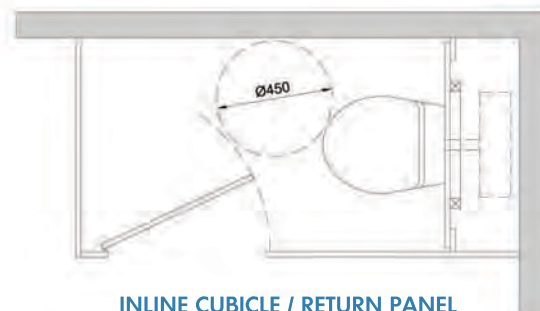

INLINE CUBICLE / RETURN PANEL

FOR FURTHER INFORMATION ON CUBICLE LAYOUTS CONTACT INFO@POSTFORMED.COM

TECHNICAL DRAWINGS: DDA

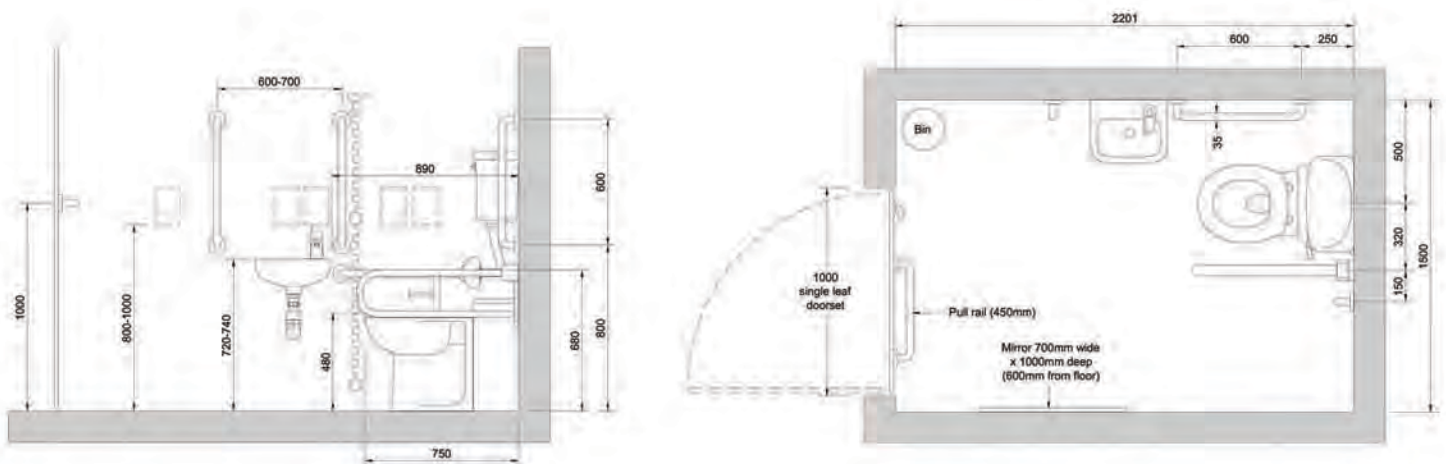
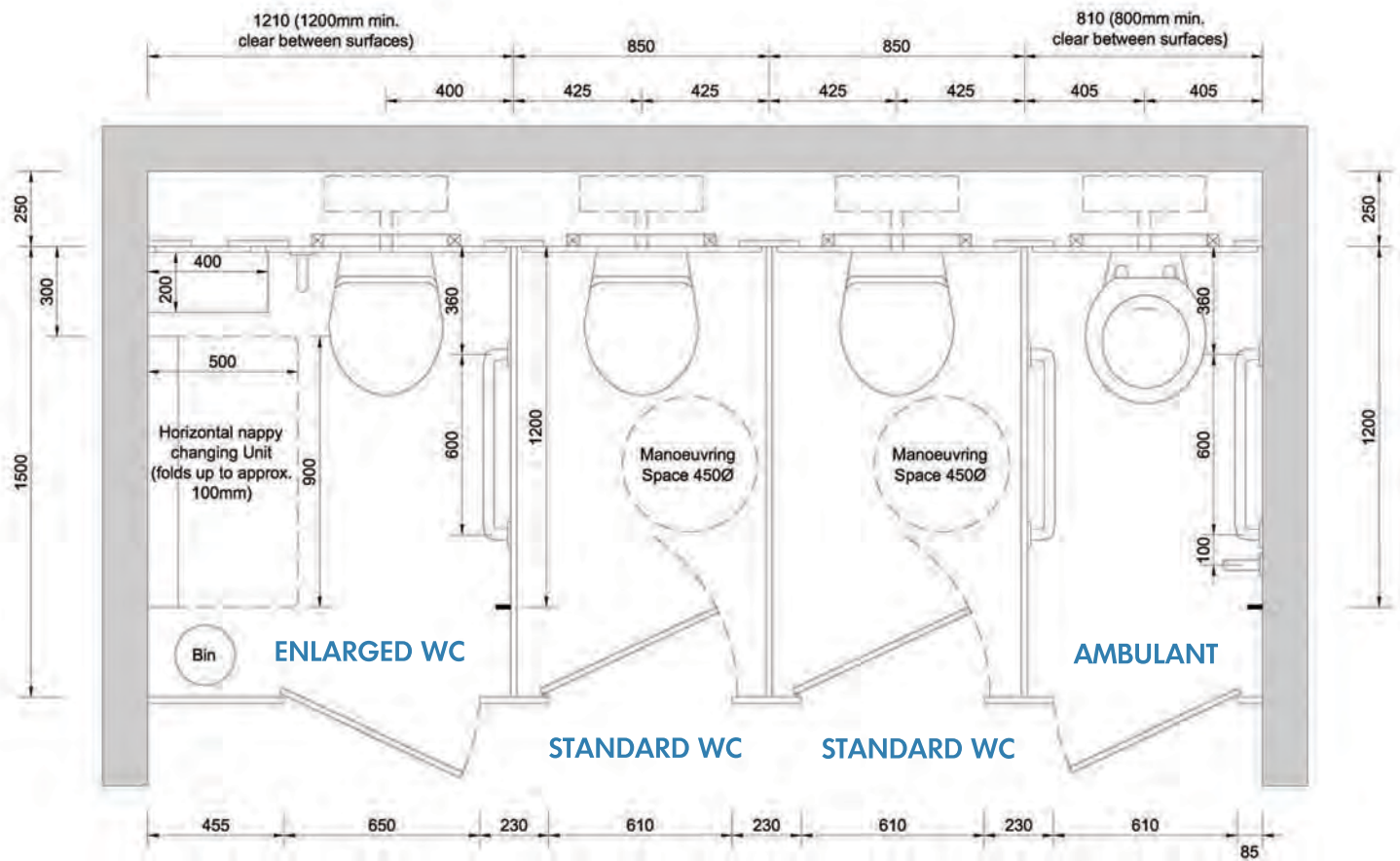

DOC M ASSEMBLIES

TECHNICAL DRAWINGS: SERVICE WALLS



Low Level WC Enclosure (Flat top)

Section



Low Level WC Enclosure (Sloped top)

Section

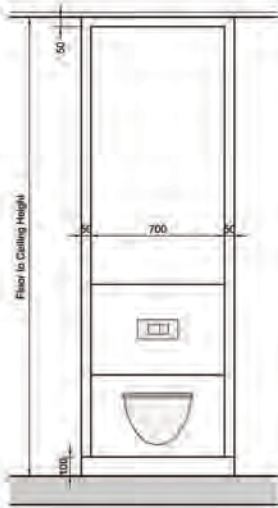

WC Elevation

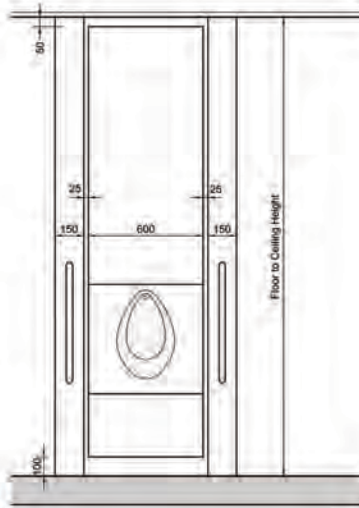

Urinal (incl. Privacy Screens)

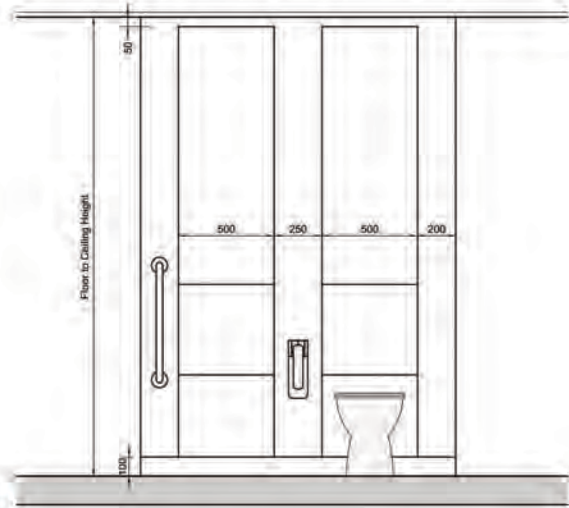

Doc M Panel Assemblies

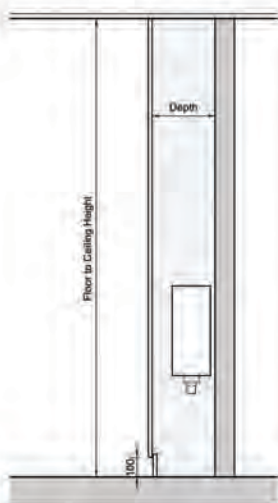

Full Height WC Enclosure

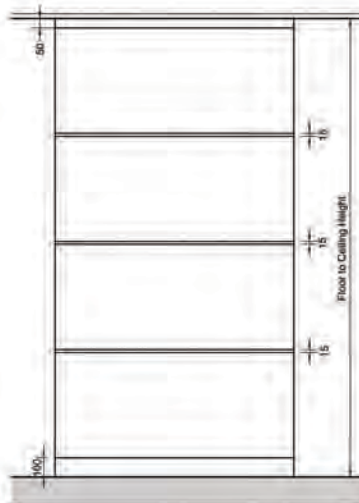

Positive Shadow Gaps



Full Height Decor Panels

TECHNICAL DRAWINGS: VANITY UNITS

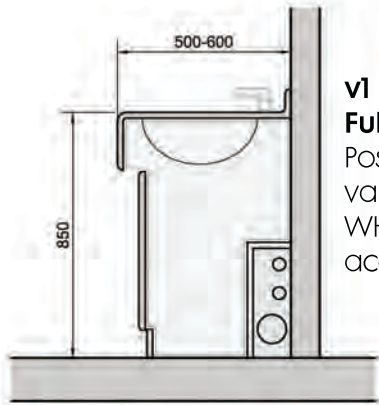

v1 Fully enclosed.
Postforming grade vanity top for inset WHB with duct access panel.

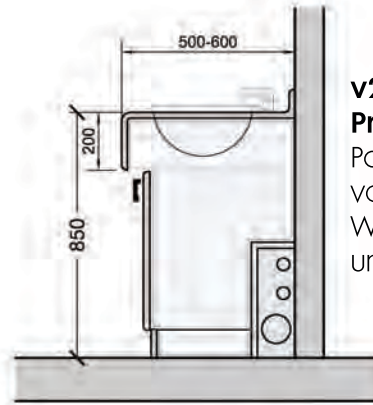

v2 Press unit enclosure.
Postforming grade vanity top for inset WHB with press unit storage .

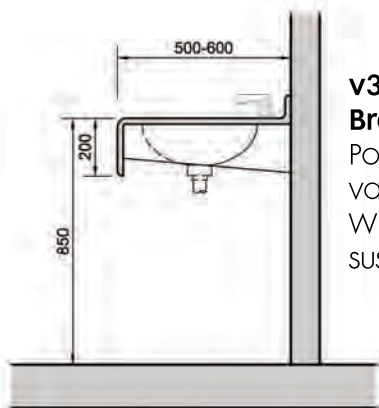

v3 Bracket suspension.
Postforming grade vanity top for inset WHB on bracket suspension .

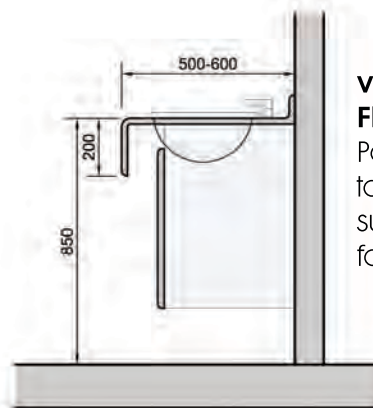

v4 Floating enclosure.
Postforming grade vanity top for inset WHB with suspended enclosure for back outlet services.

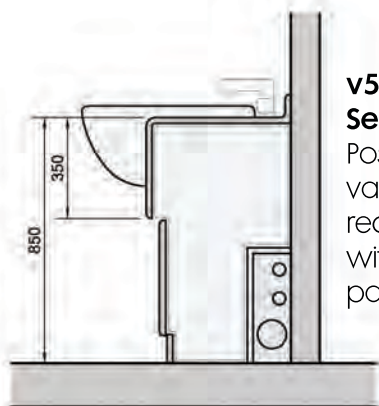

v5 Semi recessed.
Postforming grade vanity top for semi recessed WHB with duct access panel.

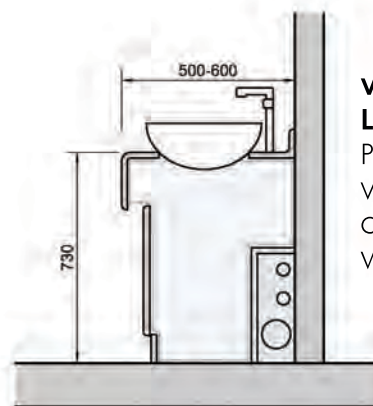

v6 Laverda.
Postforming grade vanity top to accept ceramic plant on basins with duct access panel.

All coving tops can be manufactured from solid surfacing including ceramic undermount basins or acrylic seamless wash hand basins.

TECHNICAL DRAWINGS: LOCKERS & BENCHES



PERIMETRE SEATING



PERIMETRE CANTILEVERED SEATING



ISLAND SEATING UNIT



PERIMETRE SEATING INC LOCKERS



ISLAND SEATING UNIT WITH COAT HANGERS



LOCKER CONFIGURATIONS

COLOUR CARD - VISUAL REFERENCE



F2255 Matte 58
Polar White



F5493 Matte 58
Arctic Blue



F5347 Matte 58
Maui

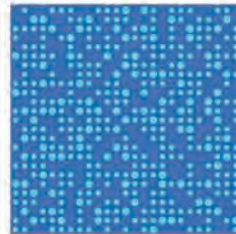

F5292 Matte 58
Midi Mode Caribbean on Oceano



F7879 Matte 58
Dusty Jade



F7927 Matte 58
Folkestone



K3737 Matte 58
Xenon



F7961 Matte 58
Fog



F7912 Matte 58
Storm



F5087 QRY
Graphite Tuff



F2273 Matte 58
Seringa



F7929 Matte 58
Oyster Grey



F7517 Matte 58
Almond Grafix



F5281 Matte 58
Dogbone White



F5278 Matte 58
Dogbone Earth



F5374 Matte 58
Elegant Oak



F5372
Vintage Wood



F6306 Matte 58
Wenge Strand



F5150 Matte 58
American Walnut

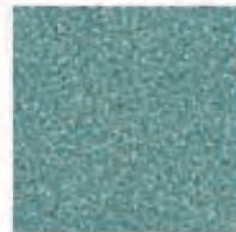

F7505 Matte 58
Dusty Jade Grafix

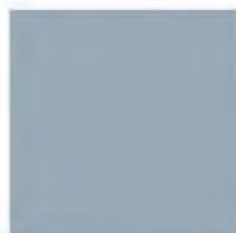

F7880 Matte 58
Thistle

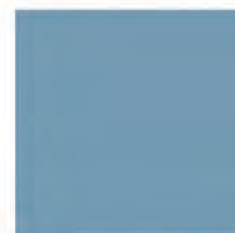

F7884 Matte 58
China Blue



F2828 Matte 58
Tropical Blue



F0233 Matte 58
Heather



F7507 Matte 58
Folkstone Grafix



F7845 Matte 58
Spectrum Red



K3210
Levante













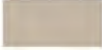



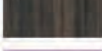







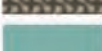



F1485 Matte 58
Chrome Yellow

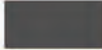

F4177 Matte 58
Lime



COLOUR REFERENCE - TABLE INDEX

	COLOUR	CODE	FINISH	FINISH	RAL	NCS	LRV
	Levante	K3210	MATT 58	SOLID	2011	S1070-Y40R	37.1
	Oyster Grey	F7929	MATT 58	SOLID	-	S2005-Y50R	48.1
	Fog	F7961	MATT 58	SOLID	7004-7036	S4000-N	36.6
	Xenon	K3737	MATT 58	PATTERNS			47.2
	Maui	F5347	MATT 58	SOLID	-	S2030-B30G	42.1
	Wenge Strand	F6306	MATT 58	WOODS	-	-	11
	Heather	F0233	MATT 58	SOLID	-	S2030-R50B	43.7
	Lime	F4177	MATT 58	SOLID	-	S1040-G50Y	56.6
	China Blue	F7884	MATT 58	SOLID	-	S3020-R90B	33.7
	Tropical Blue	F2828	MATT 58	SOLID	-	S3060-R90B	17.1
	Thistle	F7880	MATT 58	SOLID	-	S3010-R80B	39.5
	Almond Grafix	F7517	MATT 58	PATTERNS	-	-	62.8
	American Walnut	F5150	MATT 58	WOODS	-	-	
	Vintage Wood	F5372	MATT 58	WOODS	-	-	25.2
	Dogbone Earth	F5278	MATT 58	PATTERNS	-	-	19.8
	Dusty Jade	F7879	MATT 58	SOLID	-	S3020-B50G	41
	Dusty Jade Grafix	F7505	MATT 58	PATTERNS	-	-	32
	Elegant Oak	F5374	MATT 58	WOODS	-	-	35
	Folkstone	F7927	MATT 58	SOLID	-	S2500-N	53.4
	Folkstone Grafix	F7507	MATT 58	PATTERN	-	-	53.7
	Graphite Tuff	F5087	MATT 58	QRY	-	-	
	Polar White	F2255	MATT 58	SOLID	9016	S500-N	85.7
	Seringa	F2273	MATT 58	SOLID	1015	S1010-Y30R	69.8
	Spectrum Red	F7845	MATT 58	SOLID	3001	S2070-R	15.4
	Storm	F7912	MATT 58	SOLID	7015	S6502-B	14.8
	Vibrant Green	F6901	MATT 58	SOLID	6018	S2060-G30Y	32.1
	Chrome Yellow	F1485	MATT 58	SOLID	1018	S1060-Y	64.6
	Dogbone White	F5281	MATT 58	PATTERN	-		71.5
	Midi Mode Carribean	F5292	MATT 58	PATTERN	-		

CUSTOMER SUPPORT

**POST FORMED
SYSTEMS LTD.**

Postformed Systems deliver quality bespoke products with dependable service to exceed our clients expectations.



For further information please contact a member of our sales team on:

Irl Tel: +353 21 48777 33

UK Tel: 023 800 10465

Email Customer Support: info@postformed.com

Visit us online at www.postformed.com



Kingfisher
Cubicle Washrooms

WWW.POSTFORMED.COM

