



Technical Information Manual



Technical Support

At Polyflor, we realise that the performance of our products is dependent upon many factors and that the floorcovering itself is only one of those factors. Correct subfloor preparation and dryness, the workmanship of the installer, how the product is maintained and the selection of the correct floorcovering are all equally important. Our objective is to support the customer, whether it is the architect, the specifier, the contractor or the end user, by providing all the relevant information necessary to ensure that the maximum benefit is gained from our products in use.

This manual forms part of that support, together with technically trained Sales Representatives, a knowledgeable Customer Technical Services team and an installation training school.

If you have any queries regarding product selection, specification, installation, performance or maintenance of any Polyflor products, then do not hesitate to contact us. Our aim is to resolve problems prior to the installation of our products rather than have problems to resolve after they are installed.

Polyflor Customer Technical Services

Tel: **+44 (0)161 767 1912**

Web: **www.polyflor.com**

Email: **tech@polyflor.com**

At the date of issue, the data presented is correct.

However, Polyflor reserve the right to make changes which do not adversely affect performance or quality.

Index

- 1. Introduction**
- 2. Preparation of subfloors**
- 3. Installation of Homogeneous and Safety vinyl sheet**
- 4. Installation of Homogeneous vinyl tiles**
- 5. Installation of Heterogeneous vinyl sheet**
- 6. Installation of Rubber sheet**
- 7. Installation of Rubber tiles**
- 8. Electro Static Dissipative (ESD) floorcoverings**
- 9. Installation of vinyl Wallcoverings**
- 10. Installation of Accessories**
- 11. Inlaid designs and borders**
- 12. Welding vinyl flooring**
- 13. Adhesives**
- 14. Tools and Equipment**
- 15. Recommended finishes**
- 16. Resistance to chemicals**
- 17. Use area classifications**
- 18. Operating service temperatures**
- 19. Maintenance**



Introduction



British Standard Code of Practice BS 8203 provides detailed recommendations for the installation of sheet and tile flooring on both new and existing floor constructions and is endorsed by Polyflor for the installation of Polyflor vinyl and rubber flooring.

This technical information manual is intended as a guide to all parties involved in the specification, installation and maintenance of Polyflor vinyl floorcovering. It will not replace the skills of a trained floor layer and Polyflor always recommends the use of reputable flooring contractors, whose experience will prove invaluable at all stages of a project. Selecting a flooring contractor solely on price

can lead to a poor installation and a dissatisfied end user.

A successful installation not only depends on the skills of the floor layer but also on the planning of the project prior to installation. Consultation between all parties concerned will eliminate problems and will ensure a successful installation, which meets the design requirements within the allotted time scale.

1.1 PRODUCT SELECTION

Selection of the correct floorcovering is of paramount importance. Not only must the floorcovering meet the designer's initial performance specification but the product

performance must be sustainable for the anticipated life of the product, allowing for foreseeable actions such as general wear and tear and regular maintenance. This is extremely important for the Essential Requirements as defined by the European Union for all construction products.

Consideration at the initial specification stage must be given to the occupational usage of the building and the building type. Particular attention must be paid to the type and density of traffic (both pedestrian and wheeled), any special acoustical, electrical resistance or slip resistance requirements, as well as reaction to chemicals and staining agents, and physical properties such as resistance to point and rolling loads.

Should you wish to clarify any points regarding Polyflor contract flooring or accessories, then please contact Polyflor or our appointed agents. Our Technical Sales Team and Customer Technical Services Department can provide advice on the suitability, performance and application of any of the Polyflor products.

1.1.1 Project pre-planning

One important consideration at the outset is the maintenance aspects of the floorcovering to be installed. Floorcoverings with enhanced slip characteristics have a higher surface coefficient of friction and requires different maintenance than a traditional smooth floorcovering. Colour also plays a very important part and one should remember that light colours will show soiling more easily and could require a more intensive maintenance programme than darker colours.

Having decided upon your floorcovering, it is essential that the product, together with its accessories, are installed correctly within pre-defined time and budget constraints.

To achieve this, the tender documentation should include the maximum amount of information possible, such as:

1. Full details of the subfloor construction, especially on solid subfloors and any treatments or additives. Include the expected dates for completion of each stage.
2. Full details of standard features such as welding, site formed coving or pre-formed coving. In addition, it should include other features such as pattern or border detail and requirements such as door trims, diminishing strips etc.
3. Reference to any tests which must be carried out e.g. for moisture, electrical resistance, screed strength and flatness/level.
4. Drawings showing the direction of decoration or where sheet must be laid in a particular direction.
5. A statement of the standard of workmanship required, **clearly indicating items which will be unacceptable at the handover inspection.**
6. Full details of finishing requirements. These may include; removal and safe disposal of waste, retention of flooring over a certain size, a construction clean, initial polish where applicable and protection of the finished floor prior to customer handover.

By including this level of detail in the tender document, the flooring contractor is able to give an accurate costing and advise on the length of time required to complete the work at that cost. Once the tender is accepted, ideally discussions should be held to highlight any potential problems well in advance and to ascertain the services required on site when the floorcovering is installed.

2 Preparation of subfloors



The quality of a finished installation can be very much dependent upon the preparation of the subfloor and the attention paid to the recommendations made in various codes of practice and by the manufacturers of the component parts. The information contained below is given as guidance, based on many years of experience in this field.

It is important to avoid problems at the outset and as such if you are unsure of any of the information listed below, we recommend that you contact the Polyflor Customer Technical Services Department either directly in the UK,

through your local distributor for other countries or through our web site at www.polyflor.com. Alternatively, discuss your requirements with your preferred supplier of smoothing compounds and adhesives.

2.1 NEW CONCRETE AND SCREED BASES

The most common cause of failure in these types of substrate is moisture, either as construction moisture or the lack of an effective moisture barrier on direct to earth subfloors.

2.1.1 Damp proof membranes (DPMs)

All concrete bases, which are direct to earth,

must have an effective damp proof membrane incorporated within them. It should only be considered if the perimeter edges are continuous with the DPC in the walls.

A continuous polyethylene sheet 0.12mm (500 gauge) will provide an effective DPM for both monolithic and bonded screeds. The DPM should be applied over surface blinded hardcore to provide an even, smooth finish and to prevent puncturing of the membrane. All joints should be welded and then weighed down until the floor is cast.

With unbonded screeds, where there is risk of damage by subsequent screed laying operations, polyethylene sheet twice as thick (1000 gauge) should be used. All joints should be welded and then weighed down until the screed is applied.

Protection of structures against water from the ground is described in BS 8102 and the various types of DPM are described in BS CP 102 together with their applications. Some DPMs contain volatile components, which can, if not eliminated, adversely affect the adhesion of the floorcovering.

2.2 CONSTRUCTION MOISTURE

Prior to laying any Polyflor vinyl and rubber flooring, it is essential that all free water, which can affect adhesion, be allowed to evaporate from the base. The rate of drying is influenced by many factors including design of the base, ambient temperature and humidity, concrete quality, amount of construction water used, surface finish attained, use of special concrete additives and especially the thickness of the base. Because of this variability, it is difficult to give exact drying out times but, as a guide,

allow one month per 25mm for the first 50mm and an increasing time for each millimetre above this thickness.

A base 150mm thick in monolithic construction, drying from one face only, can take up to twelve months to dry sufficiently to take a floorcovering. If it is obvious at the planning stage that there will be insufficient drying time, then the situation should be discussed with Polyflor, who can offer proven alternatives to suppress the construction moisture.

2.3 MOISTURE TESTING

Polyflor vinyl and rubber flooring should only be laid on subfloors which do not suffer from rising damp or hydrostatic pressure, and where the moisture level does not exceed 75% RH in accordance with BS 8203.

The Hygrometer is the only method of test acceptable to Polyflor, and only readings taken over at least a 72 hour period should be considered to represent the moisture content of the subfloor. Subfloors with a relative humidity in excess of 75% will invariably cause failure of the bond between the substrate and floorcovering. To remedy such situations, the whole floorcovering will have to be removed, the subfloor treated to resolve the moisture problem and a new floorcovering laid. In an occupied building, this can cause severe disruption to the work routine.

To prevent these situations arising, Polyflor does not condone the practice of laying vinyl and rubber floorcoverings on subfloors with moisture content readings above 75% RH and accepts no responsibility for non-performance of Polyflor products in such instances.

In countries outside of the UK, alternative moisture measurement methods are also used. The guidelines for the maximum acceptable vapour emission rate of concrete using anhydrous calcium chloride is 3lbs per 1000 square feet per 24 hour period for all the Polyflor and Polysafe floorcoverings.

2.4 EXISTING CONCRETE AND SCREED BASES

Existing concrete and sand/cement screed bases as described in BS 8204, if laid directly to ground, must contain an effective DPM. If one is not present or is suspect, a suitable surface DPM should be applied.

In most instances, a cementitious smoothing compound of at least 3mm thickness must be applied prior to the installation of the vinyl floorcovering. The smoothing underlayment supplier will provide details on which product within their range must be used to suit the end use application and subfloor construction, together with details of which primer should be used.

2.5 POWER FLOATED CONCRETE

Power floated concrete bases as described in BS 8204, if laid directly to ground, must contain an effective DPM. If one is not present or is suspect, a suitable surface DPM should be applied. Smooth dense concrete subfloors – such as those created by a power floated finish – can prove difficult to bond to, due to the impervious nature of the surface. In such instances, the floor should initially be ground or shot blasted to remove the top surface and then made good.

In most instances, a cementitious smoothing compound of at least 3mm thickness must be applied prior to the installation of the vinyl

floorcovering. The smoothing underlayment supplier will provide details on which product within their range must be used to suit the end use application and subfloor construction, together with details of which primer should be used.

Surface hardeners or curing agents should not be used with power floated concrete, as these can also impair the adhesion of the floorcovering.

2.6 MASTIC ASPHALT UNDERLAY

Mastic asphalt underlays as described in BS 8204: Part 5 should conform to BS 6925. Comprising asphaltic cement and suitable aggregates, the asphalt is applied in its hot state onto a glass fibre quilt. Normally a thickness of 15mm to 20mm is applied and the asphalt brought to a finish with a wooden float. The resulting underlay is impervious to moisture and, if continuous with the DPC in the walls, makes an excellent subfloor for Polyflor vinyl and rubber flooring, providing a 3mm thick surface underlayment is first applied. The asphalt must not just be skim coated it is important to ensure that the smoothing underlayment is of a type recommended for use on asphalt floors and that a suitable primer key coat is applied if so directed.

Never apply Polyflor floorcoverings direct to a mastic asphalt subfloor.

2.7 MAGNESITE / GRANWOOD FLOORS

Composition floors which are composed of magnesium oxychloride cement or polyvinyl acetate/cement are highly absorbent. As such, if overlaid with an impervious material, they can break down due to the effects of rising moisture, as the majority of these floors do not

incorporate an effective DPM. In all instances where the material is laid directly to ground, Polyflor recommend that the screed be uplifted and relaid incorporating an effective DPM.

For floors that are on the first floor or above, cracks and small hollows should be patch filled and a cementitious smoothing compound of at least 3mm thickness must then be applied, prior to the installation of the vinyl floorcovering. The smoothing underlayment supplier will provide details on which product within their range must be used to suit the end use application and subfloor construction, together with details of which primer should be used.

2.8 TERRAZZO

Terrazzo has a dense hard surface, which is normally impervious. The floor must be sound and firmly fixed and any loose or powdery material removed from the joints. The surface should be thoroughly washed/degreased to remove any surface contaminants and any cracks cleaned out and filled with a suitable resin bonded cement/sand mixture. The surface may also need some mechanical abrasion to enable the smoothing underlayment to key to the surface.

In most instances, a cementitious smoothing compound of at least 3mm thickness must then be applied prior to the installation of the vinyl floorcovering. The smoothing underlayment supplier will provide details on which product within their range must be used to suit the end use application and subfloor construction, together with details of which primer should be used.

2.9 QUARRY TILES/CERAMIC TILES

Heavily glazed surfaces are quite common with

these types of flooring and tiles must be sound and firmly fixed with all loose and powdery grout removed from the joints. Generally the tiles will require mechanical abrasion of the surface in order to provide a key for the application of a smoothing underlayment. The surface should be thoroughly washed / degreased to remove any surface contaminants and then a cementitious smoothing compound of at least 3mm thickness must then be applied prior to the installation of the vinyl floorcovering. The smoothing underlayment supplier will provide details on which product within their range must be used to suit the end use application and subfloor construction, together with details of which primer should be used.

2.10 SYNTHETIC ANHYDRITE SCREEDS

This type of screed can be affected by laitance and moisture in the smoothing compound, resulting in the loss of bond. As such, it may need mechanical removal and the application of a special primer. We would always recommend that you discuss this application with your adhesive and underlayment manufacturers. If a failure occurs, it is normally below the vinyl floorcovering and as such Polyflor will not accept responsibility for failure.

2.11 EXPANSION JOINTS

Expansion joints are incorporated into buildings to permit movement without cracking. It is important that these joints extend through the floorcovering.

Never lay Polyflor vinyl and rubber flooring over expansion joints.

Proprietary expansion joint covers are available which blend with the floorcovering and disguise

the joint. Some are made of vinyl that incorporates a flexible portion and are welded to the abutting vinyl to form an impervious layer. Other types are a combination of aluminium and PVC, which again contains a flexible section.

Filling the expansion joint with sealant which is not specifically designed for expansion joint filling or floor smoothing underlayment will lead to floor failure and is not recommended by Polyflor.

2.12 TIMBER SUBSTRATES

New timber suspended floors should be constructed of either plywood or chipboard specifically manufactured for flooring. Spacing of the supportive joists should be in accordance with the manufacturer's recommendations in relation to the board's thickness.

2.12.1 Chipboard

Chipboard should have a minimum thickness of 18mm and a density not less than 700kg/m³. Preferred sizes are 600mm x 2400mm and 1200mm x 2400mm.

The chipboard should be tongued and grooved or slotted loose tongue fitting. All joints should be glued for accurate location and finished level. The board edges must be supported across the joists and where necessary by the use of noggins. The boards should be fixed at 350mm centres using annular (ring shanked) nails, lost head nails, divergent staples or countersunk screws, of length at least 2 1/2 times the thickness of the board.

For joist centres up to 450mm, 18mm thick chipboard can be used. For joist centres of 610mm, 22mm thick chipboard should be used.

All chipboard should comply with EN312, be grade P5 or P7 and should be free of sealants or coatings which are liable to adversely affect adhesion of the floorcovering, if applied directly to it.

Boards must be conditioned on-site by loose laying them individually or loose stacking them in the temperature and humidity conditions which will prevail in service, for at least 3 days prior to fixing. Boards with a moisture content of less than 7% and greater than 18%, using an electrical resistance moisture meter, should not be laid.

2.12.2 Chipboard floating floors

Wood chipboard incorporating a laminated foam backing, or loose laid insulation quilting or similar, and used as an underlayment for floorcoverings, should comply with the requirements of BS 7916. The chipboard must not have been coated with any type of sealer, which makes the surface impervious, such as wax or polyurethane, as they will impair the bonding of the adhesive to the floorcovering.

Boards must be conditioned on site, by either loose laying them individually or loose stacking them in the temperature and humidity conditions which will prevail in service, for at least 3 days prior to fixing. Boards with a moisture content less than 7% and greater than 18%, when measured with an electrical resistance moisture meter, should not be used.

Floating floors are designed to allow movement in both the vertical and horizontal planes.

Problems can occur at the joints of the chipboard where movement in either plane is excessive. It is Polyflor's recommendation that

the boards should be overlaid with flooring grade plywood with a minimum thickness of 4mm, with the plywood laid half bonded over the chipboard joints, stapled or nailed as described in Section 2.12.6.

2.12.3 Plywood

Plywood should be grade "good one side" specification CSA 0121 sanded. The boards should be 1200mm x 2400mm and of minimum thickness 15.5mm. The boards should be laid with the longer side at right angles to the joists and the shorter side must have solid bearing on the joists. Fixing should be carried out at 300mm centres with annular (ring-shanked) nails or lost head nails of length at least 2 1/2 times the thickness of the board or divergent staples. For joist centres up to 450mm, 15.5mm thick plywood can be used. For joist centres of 610mm, 18mm thick plywood should be used as described in Section 2.12.6.

2.12.4 Wood blocks

Although many woodblock floors appear sound, even when overlaid with plywood, the application of an impervious floorcovering on a direct to earth subfloor can cause expansion and lifting of the base. Polyflor recommends that, in all cases, the woodblock floor be removed and the subfloor brought up to the required standard to accept Polyflor vinyl and rubber flooring.

2.12.5 General

All nail and screw heads must be below the surface of the board and any indentation filled with a suitable flexible underlayment, as should the joints between any boards that have been used to overlay the existing floor. The surface should be primed using a primer compatible

with the adhesive, as recommended by the adhesive manufacturer. The primer will minimise adhesive usage and maintain the open time of the adhesive and prevent preferential absorption.

2.12.6 Existing wooden floors

Existing wooden floors may have received a preservative treatment that will cause poor bonding, due to a chemical interaction between the preservative and the adhesive. In such cases, they should not be laid onto directly.

All loose boards should be firmly nailed to the joists and any worn or broken boards replaced. The floor should be sanded to remove high spots and any hollows or cracks filled with a suitable flexible underlayment.

The existing wooden floors should then be overlaid with exterior grade WBP plywood of 4mm or 6mm thickness and preferred size 1200mm x 1200mm. The boards should be laid with staggered joints. The plywood should be fixed to the existing boards using 18mm long divergent staples or 14 gauge screw nails of 25mm length. Both types of fixing should be at 100mm centres along the edge of each sheet, with a fixing line 12mm from the edge and thereafter at 150mm centres throughout the entire area of the sheet. Perimeter fixings must not be more than 18mm from the board edges.

Hardboard manufactured to BS 1142 can be used as an alternative to plywood. Preferred sizes are 1200mm x 1200mm x 3.2mm thick. It should be noted that hardboard can suffer from extreme dimensional change when in contact with water. To minimise this change, the hardboard should be wetted on the mesh side and left overnight to dry, prior to fixing.

Failure to wet the hardboard can result in buckling due to moisture absorption from the water-based adhesive.

Plywood and hardboard should be treated as described in Section 2.12.3 prior to application of the floorcovering.

With suspended timber at ground level, it is of vital importance to obtain good ventilation below the floor through the existence of airbricks. Without good ventilation, the application of an impervious floorcovering could lead to dry rot in the structure beneath.

Most smoothing compounds are unsuitable for applying to timber bases due to the movement of the base. Seek advice from the smoothing underlayment manufacturer for the correct grade of product for your specific application.

Cementitious smoothing compounds should only be used to patch fill hollows on timber substrates. Once level, they should be overlaid with flooring grade plywood, as described previously.

2.13 OTHER SUBSTRATES

2.13.1 Metal bases

Metal bases are generally, but not exclusively, steel and can be contaminated with rust or oxidation, oil and grease. The surface should be thoroughly degreased and then abraded or wire brushed to remove the rust or oxidation. Any high spots may need to be ground off.

In most instances, but not where there is excessive vertical or lateral flexing or movement, a cementitious smoothing compound of at least 3mm thickness must then be applied prior to the installation of the vinyl

floorcovering. The smoothing underlayment supplier will provide details on which product within their range must be used to suit the end use application and subfloor construction, together with details of which primer should be used.

2.13.2 Painted or epoxy coated floors

Epoxy and polyurethane surface coatings should be removed, in order to ensure that no breakdown of the sub-floor occurs after installation of the resilient floorcovering.

Painted floors will impair the adhesion of the resilient floorcovering and should be removed prior to the application of the floorcovering. Mechanical methods such as grinding or blasting are the most suitable methods for removing these coatings. However, where the paint proves difficult to remove, the floor may need to be scabbled. If the epoxy coating is well bonded to the subfloor, it is possible to apply the floorcovering after grinding or blasting. In both instances, the surface should then be made good with a 3mm minimum coating of a suitable cementitious smoothing underlayment applied in accordance with the manufacturer's recommendations, which may include the application of a primer key coat.

2.13.3 Loose lay isolating membranes

Polyflor recommend that subfloors be prepared in accordance with the relevant code of practice BS 8203. Any installations incorporating loose lay isolating membrane systems within the marketplace, which are used to overlay contaminated subfloors, existing floor coverings, etc. are solely underwritten by the individual membrane manufacturer.

2.13.4 Existing floorcoverings

Polyflor vinyl and rubber flooring should never be laid over existing floorcoverings and in such instances where this is carried out, Polyflor accepts no responsibility for non-performance of its products.

All existing floorcoverings must be uplifted and as much as possible of the old adhesive removed from the subfloor. Special care must be taken on very old floors, as some products - but not Polyflor - contained asbestos. In these instances, contact Polyflor for further information.

The removed floorcoverings should be reclaimed and recycled, providing that there is no heavy contamination. Polyflor is one of two founder members of Recofloor, the industry funded vinyl take-back scheme. To enquire about this scheme and recycling end of life vinyl flooring (uplifted and off-cuts), email Recofloor at recofloor@axionconsulting.co.uk.

A suitable 3mm thick floor smoothing underlayment should then be applied to the whole floor. Failure to remove sufficient adhesive can lead to premature failure of the underlayment.

After uplifting existing floorcoverings laid on plywood and hardboard, used as fabricated underlays, it is almost always necessary to replace the plywood or hardboard.

After uplifting existing floorcoverings laid on suspended chipboard or plywood subfloors, 4mm thick plywood should be applied to the subfloor as described in Section 2.12.6.

2.13.5 Access Panels

When access is no longer required beneath a floor and it is proposed for access panels to be overlaid, provided the panels are sound and level, Polyflor would recommend that a minimum 6mm WBP Plywood is installed over the access panel and adequately fixed. A suitable smoothing compound should then be used to fill any joints and hollows.

2.13.6 Subfloors

In common with the installation of any type of flooring, the subfloor should not only be in sound condition, but also free of any contaminants, like oil, paint, preservative treatments or other forms of marking, such as a permanent marker pen.

Similarly, no markings should be applied to the back of heterogeneous flooring.

Installation of Homogeneous and Safety vinyl sheet



On receipt of rolls, check that colours correspond to those ordered, that quantities are correct and that there is no damage. In particular, check that rolls are from one batch, if that was requested on the order. On arrival at site, the rolls should be safely secured in an upright position and stored, together with the adhesive, at a minimum temperature of 18°C for at least 24 hours before laying.

Inflammable adhesives require special storage conditions. Contact the adhesive manufacturer or see current literature for details.

To achieve best results, site conditions should

be as described in BS 8203. A working temperature of between 18°C and 26°C is required for at least 24 hours prior to, and during, the laying period and for 24 hours afterwards. Conditioning areas and laying areas should be of similar temperature, to prevent thermally induced dimensional changes.

In installations where underfloor heating is used, this should be switched off from 48 hours prior to installation until 48 hours afterwards. It should then be slowly brought back up to the working temperature, a maximum of 27°C.

Adhesives capable of withstanding

temperatures up to 27°C should be used. Where direct sunlight, sometimes in conjunction with underfloor heating, creates high surface temperatures on the floor, an approved epoxy or polyurethane adhesive should be used.

The work area should now be prepared to receive the vinyl sheet flooring. Ensure that all other trades have completed their work and removed all their equipment and materials. Remove all debris and sweep or vacuum the whole floor area. Check the condition of the subfloor and make good as necessary. Stone or power grind any cementitious subfloor to remove any "nibs" or ridges. Remove any surface contaminants, which may affect adhesion. Sweep or vacuum again prior to laying. If required by the contract, or if in doubt, check the moisture content of the subfloor and record the results and method used. Good lighting is essential.

It is important to note that commencement of work is deemed by many as acceptance of the site conditions as being suitable for laying floorcoverings.

3.1 LAYOUT OF VINYL SHEET

The architect may have provided a drawing showing the direction in which the material should be laid. In this case, lay the vinyl sheet as directed. If the architect has left this to the discretion of the flooring contractor, it is advisable to show at the tender stage in which direction the material will be laid and state that your estimate is based on this. Always pay particular attention to where seams will fall, avoiding such occurrences as seams in the centre of doorways. If large windows are installed, minimise the effect of the joints by

laying towards the window.

3.2 SLABBING THE VINYL SHEET

Polyflor recommends that all Polyflor vinyl sheet flooring be rolled out face upward, taking care not to damage the surface, and cut approximately to size. Allowance of at least 75mm should be made at the ends for trimming in, the slabs should then be left overnight for 24 hours, to condition at a minimum temperature of 18°C.

3.3 FITTING THE FIRST LENGTH

3.3.1 Non-foam backed products

Place the first sheet in position next to the wall with the outer edge approximately 15mm from the nearest point. Adjust the lie of the sheet so that the inner edge is parallel with the axis of the room (Figure 1).

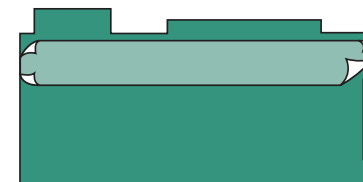

Figure 1 Lining up the first sheet

Depending upon the depth of the recesses, either a bar scriber or a pair of scribes should be used to trace the profile of the wall. The scribes should be set to allow for the deepest recess or rake of the wall. Holding the scribes vertically and square to the vinyl edge, trace the wall profile onto the face of the sheet (Figure 2). With this method, all irregularities of the wall will be accurately reproduced onto the surface of the vinyl sheet. If, because of the colour or decoration, the scribed line is difficult to see, rub suitably contrasting chalk dust into the line to highlight it.



Figure 2 Scribing the wall profile

Ease the sheet away from the wall and, using a hook blade trimming knife, cut off the excess vinyl to the scribed line. Slide the sheet back against the wall and check the fit, making any minor adjustments as necessary.

When satisfied that the fit on the first edge is correct, use a pencil to trace the opposite edge onto the subfloor (line A-B in Figure 3).

In the centre of the room, draw a line on both the vinyl and subfloor square to the main axis of the sheet (line C-D in Figure 3).

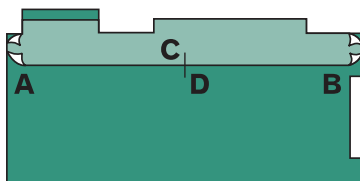

Figure 3 Marking the position

Keeping the inner edge of the vinyl on line A-B, slide the sheet back to clear the wall at one end of the room.

Set the scribes to the distance now between lines C and D (Figure 4). Trace the end wall

profile and cut to fit as described in preceding paragraphs.

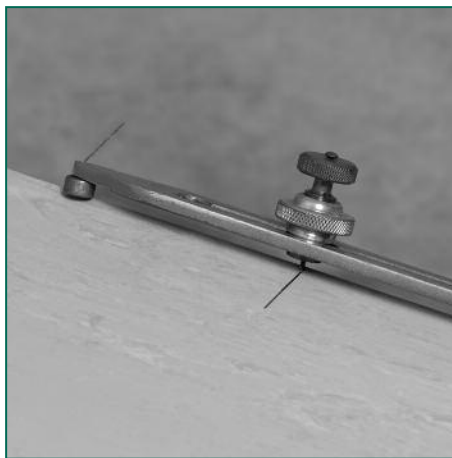

Figure 4 Setting the scribe

Repeat for the other end of the sheet. Once completed, the whole sheet - when slid back into position - should fit the wall profiles exactly.

Note: If fitting to set-in coving, the same principles apply but a reverse scribe must be used to trace the toe onto the sheet. It is normal to free hand cut to the coving, allowing 12mm overlap for final trimming in.

3.4 FITTING SUBSEQUENT LENGTHS

Place the second length parallel to the first length, with a maximum 25mm overlap along the adjoining edges. On the opposite side, trace the edge along the whole length onto the subfloor. In the middle, draw a line C-D at right angles to the main axis, as previously described.

Using the longitudinal line as a guide, slide back the sheet from the end wall and fit as described in Section 3.3.1. Repeat for the opposite end. Repeat the sequence for all remaining lengths. On the final length, which abuts the opposite

wall, fit as described for the first length (Section 3.3.1).

3.5 CUTTING IN THE SEAMS

Polyflor recommends that all Polyflor vinyl sheet floorcoverings are welded. Seam cutting, grooving and heat welding are described in detail in Section 12.

Note: The seams should be cut before the adhesive is spread.

3.6 ADHERING THE VINYL SHEET

Prior to adhering the vinyl sheet, it is important to read and understand the adhesive manufacturer's instructions, recommendations and safety advice. You need to know the hazards and limitations of the adhesive, especially the open time.

Never spread more adhesive than can be laid within the open time. Polyflor does not recommend any method of adhesive application, such as rolling or spraying, which cannot guarantee the spread rate.

3.6.1 Wet set adhesives

Wherever practical, start with central strips first, as these are usually easier, having fewer recesses or awkward fittings.

A. Fold back the sheet to just over half its length, making sure the remaining half retains its position.

B. Spread the adhesive using a notched trowel of the correct size, as recommended by the adhesive manufacturer. Maintain the correct size of notch at all times, recutting as necessary as work progresses.

C. When the adhesive is ready to accept the floorcovering, roll the vinyl sheet back into place, rubbing from the centre to the edge, taking care not to twist the roll or trap air bubbles.

D. Check that seams are without gaps and remove any excess adhesive.

E. Roll with a 68kg articulated floor roller, firstly in the short direction, then in the long. In corners and other awkward areas, use a hand roller.

F. Repeat over the whole floor until all the sheets are adhered.

G. Roll the whole area thoroughly again, between one and four hours later.

3.6.2 Adhering foam-backed vinyl sheet

Trim the material to size ensuring that approximately 150mm excess remains along the length of the material at both edges of the room. Spread the adhesive until 1 linear metre away from both edges of the room, and place the vinyl into position. The vinyl can then be rolled.

Once this has been carried out the edges of the length of material can then be trimmed and bonded.

Further advice can be obtained from Polyflor Customer Technical Services Department.

3.6.3 Premature trafficking of newly laid floors

Early trafficking may disturb the adhesive bond and weaken it, resulting in the associated problems of tracking, indentation, debonding etc. After the vinyl sheet has been installed, only light foot traffic should be allowed for at least 24 hours. Furniture etc. should only be returned after this time. Where liable to be subject to heavy trafficking, the vinyl should be protected with hardboard or plywood for at least 48 hours.

3.6.4 Pressure-sensitive adhesives

These adhesives are designed to go completely dry prior to laying into and are particularly well

suiting to dense subfloors where there is difficulty with moisture uptake. They have the advantage of very long open times but, because they are laid into dry, have the disadvantage that the adhesive ridges are not flattened when the vinyl is rolled. To eliminate this disadvantage, Polyflor recommends an alternative method of application:

A. Fold back all the sheets to just over half their length.

B. Spread the adhesive with the correct notch trowel. Maintain the correct size of notch at all times. Then roll out the adhesive ridges with a long handled, short pile adhesive roller.

Note: To maintain the correct spread rate, the adhesive roller should be pre-wetted with adhesive. This will prevent it taking adhesive from the floor.

C. Wrap the roller in a polyethylene bag and hang up when not in use. This will prevent it from drying out. It also prevents flats being formed and avoids regular washing out and pre-wetting.

D. When the adhesive is completely dry and ready to lay into, it will change from opaque to clear or translucent. The adhesive will be tacky to the touch. It is worth remembering that air flow is the most critical factor in the drying time and not temperature. Electric fans can be used to accelerate the drying time.

E. Place a length of 100mm wide polyethylene strip onto the edge of the adhesive adjacent to the fold in the vinyl sheet (Figure 5). This will prevent the sheet sticking to the last 100mm of adhesive.

F. Roll the central sheet back into place along the longitudinal line, taking care not to twist the roll

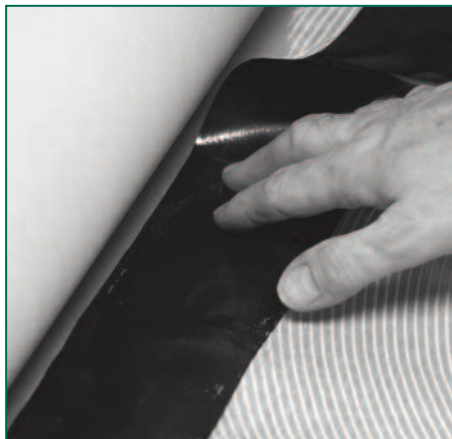

Figure 5 Polyethylene strip

or trap air bubbles. (A length of wide polyethylene strip can be rolled out on top of the adhesive to enable it to be walked on. This can be helpful when fitting the first length up to the line. Roll it up from the far end on completion.)

G. Fit all the other sheets, working outwards from the central sheet, as described previously. Take extra care to ensure that seams are without gaps and remove any excess adhesive as work proceeds.

H. Fold back the second halves of the vinyl sheets and remove the polyethylene strip which was stuck to the edge of the adhesive. Repeat sequence of adhering vinyl sheet as described previously.

I. Roll thoroughly in both directions using a 68kg articulated floor roller. In corners and other awkward areas, use a hand roller. Repeat again after 1 – 4 hours.

3.7 PATTERN TEMPLATE METHOD

Areas which call for a considerable amount of fitting around obstacles, or which are too confined to lay down a sheet for fitting by normal methods, can be dealt with by templating the floor in felt paper.

Note: In new buildings, it may be worthwhile discussing installation with the main contractor who may agree to fitting WCs, sinks etc. after the vinyl has been laid.

A. Dry fit the area with felt paper, leaving a gap of 15mm to 20mm around obstructions and walls.

B. Draw around the fittings using a compass set at 25mm. Mark the template "This Side Up".

C. Place the vinyl sheet in a larger area with the face uppermost. Place the template on top ensuring the direction of decoration is correct. Secure the template firmly in position and, with a pair of scribes set at 25mm, mark the position of all obstacles using the template as a guide.

D. Using a sharp vinyl trimming knife, cut the vinyl sheet to the scribed lines and fit into position.

Note: Do not use the felt paper template as an underlay.

3.8 SITE FORMED COVERED SKIRTINGS

Polyflor fully flexible vinyl flooring, in conjunction with Polyflor Ejecta cove former (see also Section 9) can be used to create site formed covered skirting. In shower areas, for example, the vinyl sheet can be extended up the wall and, when welded, will form a watertight base. Alternatively, in hospital corridors or office complexes, a contrasting colour can be used for decoration or identification.

A. Adhere the sections of cove former using a contact adhesive. Use a mitre-block to accurately cut internal and external corners and only adjust for length on straight cuts.

Note: The installation of Polyflor Ejecta vinyl flooring accessories using contact adhesives is covered in detail in Section 10.

B. To prevent a difficult fit, and potential weak spot near doorways, cut away the back edge of the cove former on a taper for 150mm so that there is minimal cove former near the doorway (Figure 6). Heating the cove former will enable the shape to be formed but do not use a naked flame.

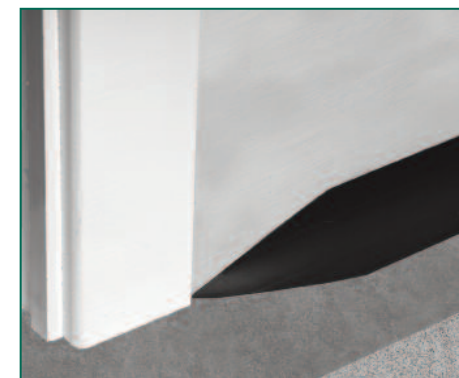

Figure 6 Taper towards a doorway



Figure 7 CS-N capping strip

3.8.1 Fitting with clip-in capping strip (Type CS-N)

- A.** Draw a line on the walls around the room to the height the coving will reach.
- B.** Place the vinyl to the walls and then draw a line to the same height as previous. Using a straight edge and sharp knife, trim off the excess.
- C.** Pull back the sheet from the walls. Fit the capping strip to the wall with contact adhesive so that the top of the sheet will sit inside the cap.
- D.** Apply contact adhesive to the face of the cove former and up to the capping strip. Coat the back of the vinyl with contact adhesive and leave both to dry.
- E.** When dry, push the vinyl into place and tuck the top edge into the capping strip (Figure 7). Roll with a hand roller to ensure even contact.

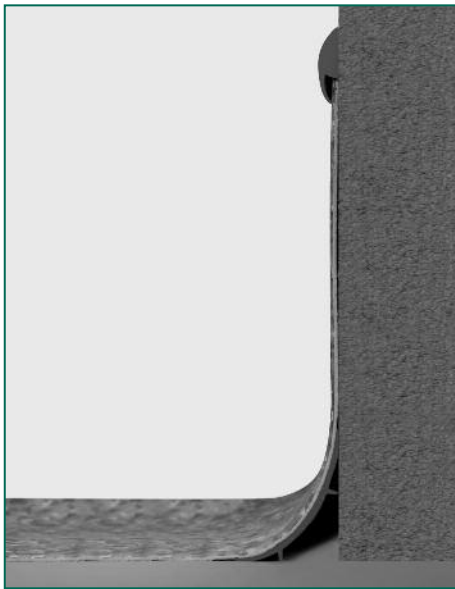

Figure 8 CS capping strip

3.8.2 Fitting with sit-on capping strip (Type CS)

- A.** Using a height gauge fitted with a pencil, draw a line on the walls around the room to the height the coving will reach.
- B.** Apply contact adhesive to the face of the cove former and up to the pencil line on the wall. Coat the back of the vinyl with contact adhesive and leave both to dry.
- C.** When dry, push the vinyl into place and roll with a hand roller to ensure even contact.
- D.** Reduce the height gauge to allow for the thickness of the floorcovering and adhesive. Draw a line on the vinyl to the same height as previous. Using a straight edge and sharp knife, trim off the excess.
- E.** Using a piece of capping strip, mark where the strip overlaps the wall and vinyl sheet. Apply contact adhesive between the lines and to the back of the capping strip. When dry, push into place (Figure 8).



Figure 9 External corners

Note: Welded external corners are prone to breaking open due to damage from wheeled traffic. To prevent this from occurring, and as an alternative to the traditional mitre, the joint may be cut at an angle and taken around the corner and welded (Figure 9).

3.9 FITTING TO CERAMIC WALL TILES

For the junction between site formed covered skirting and ceramic wall tiles, Polyflor Ejecta CT strip should be used. The flexible section is designed to accept ceramic tiles on one side and various gauges of vinyl on the other.

The Polyflor CT strip should be adhered using a contact adhesive as recommended by Polyflor. The edge between the CT strip and the ceramic tiles should be grouted. The Polyflor should be fitted into the bottom edge of the CT strip and

adhered to the wall using a contact adhesive as recommended by Polyflor. See also Section 15. A thin bead of mastic sealant should be run along the underside edge of the CT strip and the Polyflor (Figure 10).

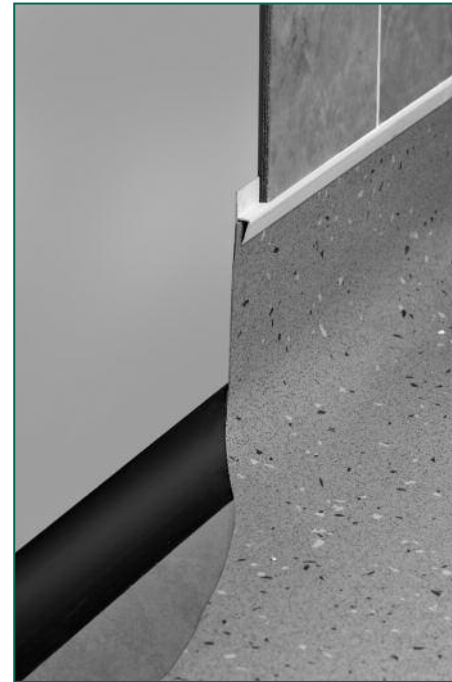

Figure 10 Fitting to ceramic tiles

4 Installation of Homogeneous vinyl tiles



This section is intended for the contract ranges of Polyflor tiles and not the Luxury Vinyl Tile ranges, which are detailed in their own specific technical manual.

On receipt of tiles, check that colours correspond to those ordered, that quantities are correct and there is no obvious damage. In particular, check that tiles are from one batch, if that was requested on the order. On arrival at site, the tiles should be stored, together with the adhesive, at a minimum temperature of 18°C for at least 24 hours prior to laying.

Inflammable adhesives require special storage conditions. Contact the adhesive manufacturer or see current literature for details.

Under normal conditions (outside temperature above 12°C) the tiles should be off-loaded from the pallet and stacked no more than five boxes high during the conditioning period. The stacks should be arranged to allow the air to circulate around stack on all sides. In cold weather (outside temperature below 12°C) the boxes should be opened and the tiles spread out in the area where they are to be installed. This will permit the tiles to acclimatise more

quickly and is especially important with high vinyl content products such as Polyflor Prestige PUR and Polyflor Mystique PUR.

To achieve best results, site conditions should be as described in BS 8203. A working temperature of between 18°C and 26°C is required for 24 hours prior to, and during, the laying period and for 24 hours afterwards. Conditioning areas and laying areas should be of similar temperature, to prevent thermally induced dimensional changes. In installations where underfloor heating is used, this should be switched off from 48 hours prior to installation until 48 hours afterwards. It should then be brought slowly back up to the working temperature, a maximum of 27°C. Adhesives capable of withstanding temperatures up to 27°C should be used. Where direct sunlight, sometimes in conjunction with underfloor heating, creates high surface temperatures on the floor, an approved epoxy or polyurethane adhesive should be used.

The work area should now be prepared to receive the vinyl tiles. Ensure all other trades have completed their work and removed all their equipment and materials. Remove all debris and sweep or vacuum the whole floor area. Check the condition of the subfloor and make good as necessary. Stone or power grind any cementitious subfloor to remove any “nibs” or ridges. Remove any surface contaminants that may affect adhesion. Sweep or vacuum again, prior to laying. If required, check moisture content of the subfloor and record the results and method used. Good lighting is essential.

It is important to note that commencement of work is deemed by many as acceptance of the site conditions as suitable for laying floorcoverings.

4.1 LAYOUT OF VINYL TILES

Although many floor layers regard vinyl tiles as being easier to lay than vinyl sheet, the layout of the tiles can be critical to the success of the installation. The regular form of tiles, especially when laid in contrasting colours, can accentuate deviations in the building line, emphasising the need for detailed planning of the layout. Many floor layers start in the main doorway, believing that the initial impression when entering a room is most important. However, working from the centre of the room and loose laying tiles to check the layout will make the final appearance correct from any viewpoint. This is especially important where a geometric design is incorporated into the floor.

4.2 MEASURING AND MARKING OUT

A. Measure the room to be laid in both directions, including any alcoves etc.

B. Mark a chalk centreline A-B, ensuring that it is square to the wall with the doorway.

C. Loose lay tiles away from the centreline A-B and check that no small strips will have to be laid at the perimeter of the room. If small strips do result, move the centreline in either direction, keeping it parallel to the line A-B, so that the perimeter tiles will only require a small piece cutting off.

D. Mark a chalk centreline C-D, ensuring that it is square to the line A-B. Check squareness with a large square, trammels or geometrically.

E. Loose lay tiles away from the centrelines C-D and check that no small strips will have to be

laid. Adjust centreline C-D as described for A-B. In Figure 11, by moving the centreline C-D towards the door, tile 6 would only require a small amount to be trimmed off, as would tile 8 on the opposite wall.

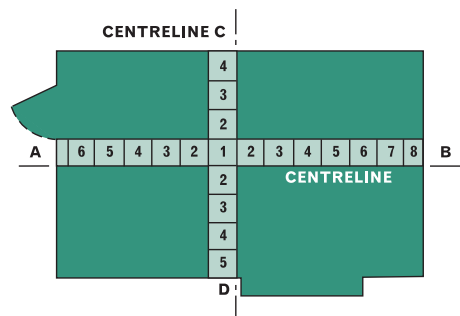

Figure 11 Laying out vinyl tiles

4.3 SPREADING THE ADHESIVE

If the subfloor is porous, it should be primed using a primer compatible with the adhesive, as recommended by the adhesive manufacturer.

The amount of adhesive that can be spread at any one time depends upon the prevailing site conditions, such as temperature, humidity and throughflow of air - all of which affect the open time of the adhesive.

Adhesive manufacturers provide details of the open time, and their instructions should be followed. Ideally, the floor area should be divided into workable sections, leaving the perimeter tile areas unadhered until the main body of the floor has been laid.

As an alternative to wet set adhesive, a pressure sensitive acrylic adhesive can be used. Although initially more expensive, half a large room can be spread at one time and the excellent "tack" of the adhesive makes it ideal for tiles. Installations that involve a large

amount of fitting also tend to be cleaner, since the tiles are laid into dry adhesive. There is an added benefit with this adhesive in the fact that once the adhesive has dried, the marking out on the floor can be seen through the adhesive film.

4.4 ADHERING THE MAIN FIELD OF TILES

The decoration of tiles on some product ranges is randomly distributed and in marbled styles can be heavier on some tiles than others. To prevent "heavy" and "light" areas, the tiles should be unboxed and, if required, "shuffled" whilst waiting for the adhesive to "go off".

Once the adhesive is ready to accept the tiles, place the first tile at the starting point, which is the intersection of the two centrelines. Press well down in the centre of the tile and then run a thumb around the edge, ensuring that all air is expelled.

Place the next tile in position, alternating the direction of marbling and colour if necessary, and proceed down the centreline, laying two tiles wide i.e. one tile either side of the centreline. It is essential to keep the tiles exactly on the centreline.

Note: Non-directional tiles do not need "shuffling", nor do they require laying in alternating directions.

Repeat the sequence along the centreline, at right angles to the first. Then, working from the completed centrelines, finish the section, taking care that tile bond is maintained throughout. Any excess adhesive should be removed as work proceeds. When a section has been laid, except for the perimeter, it should be thoroughly rolled in both directions with a 68kg articulated floor roller. Repeat for each

section until the main field of tiles has been laid.

4.5 CUTTING THE PERIMETER TILES

Three techniques are commonly used for cutting perimeter tiles. The choice is mainly dependent upon the runout of the wall.

4.5.1 Overlapping Method

Used when there is little or no run out of the abutting wall.

A. Place the tile to be cut exactly over the last tile laid, ensuring the colour is correct and the decoration runs the correct way.



Figure 12 Measuring using an overlapping tile

B. Place another full tile on top of the tile to be cut with its "top edge" against the wall or set-in coved skirting (Figure 12).

C. Scribe a line onto the tile to be cut, using the "bottom edge" of the top tile as a guide.

D. Cut the tile to the scribed line, loose lay into position and check the fit. Repeat along the whole wall.

4.5.2 Scriber Method

Used when the wall run out is quite severe or when the wall profile cannot be picked up using a straight edge.

A. Place the tile to be cut exactly over the last tile laid, ensuring the colour is correct and the

decoration runs the correct way.

B. Set the bar scriber to the size of tile being laid.

C. Trace the profile of the wall onto the tile to be cut, ensuring the bar scriber is kept upright and square to the edge of the tile.

D. Cut the tile to the scribed line, loose lay into position and check the fit. Repeat along the whole wall.

Note: Both the Overlapping and Scriber Methods can be used to fit around projections such as door frames. Similarly, a template can be made or templating guide containing movable pins used for awkward shapes.

4.6 ADHERING THE PERIMETER TILES

Once a wall edge has been fitted and loose laid, turn all the tiles inward so as not to lose their position. Spread the adhesive right up to the edges. When the adhesive has lost sufficient moisture, lay the perimeter tiles. Wipe up excess adhesive as work progresses. Roll well with a 68kg articulated roller. Use a small hand roller in areas that are inaccessible. Repeat the process for all four walls. Finally, the whole floor should be given a second rolling, approximately one to four hours later.

4.7 INSTALLING TILES IN LARGE AREAS

Maintaining a clearly defined straight line over long distances can be difficult and often leads to inaccuracies. To eliminate this problem, an alternative technique is used when laying tiles in large areas:

A. Establish the central starting point, as described previously, minimising small cuts on perimeter tiles.

B. Lay the first pyramid of tiles from the centrelines, using the sequence shown in

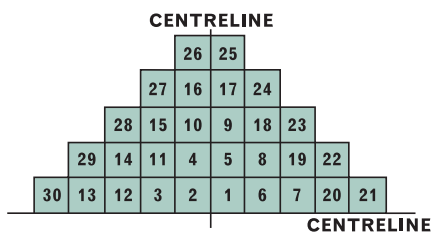

Figure 13 Pyramid layout

Figure 13. Ensure a close bond is maintained at all times.

C. Repeat this sequence on the opposite side of the centreline shown as area 2 in Figure 14.

Continue working in larger and larger pyramids, as shown in Figure 14, until only the perimeter tiles require fitting.

Note: Construction of a pyramid should always start at the centre of the baseline, working in the same sequence as shown in Figure 13.

D. Fit the perimeter tiles as described in Section 4.5.

4.8 WELDING OF TILES

Polyflor recommend that all 608mm tile installations be heat welded, as undulations in the subfloor can cause the tiles to go out of bond, resulting in slight but unacceptable gaps. Heat welding is described in Section 12.

The use of a contrasting weld rod can be used to create simple design effects. To calculate how much weld rod is required for the installation, multiply the number of square metres laid by 3.3, to give you the number of linear metres of weld rod.

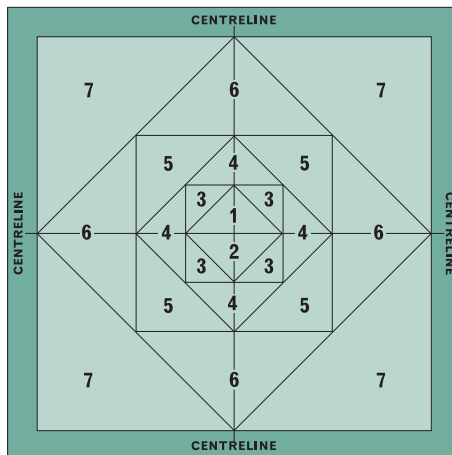

Figure 14 Floor layout

Installation of Heterogeneous vinyl sheet



This section is intended for Polyflor heterogeneous sheet vinyl ranges with transparent wear layer/print construction. In general, the installation procedure is the same as that detailed in Section 3 and reference should be made to this section for in-depth advice. Included below are details of how installation differs from homogeneous vinyl sheet, specifically in relation to alignment of adjacent sheets and welding options.

5.1 ALIGNMENT OF DECORATION

This type of floorcovering features a print layer with a regular, repeat decoration (e.g. wood plank). With wood effect designs, to maximise

the final appearance of the installation and to ensure the decorative effect is not lost, it is important that care is taken to align the plank decoration of each adjacent sheet. All none wood effect designs within the Stone FX and Gallery FX Acoustic collections MUST be reverse laid.

Once the adjacent sheets are aligned, the seam should be cut using one of the following methods:

Using a straight edge and keeping the utility knife upright, cut through both layers to ensure there is a tight seam. With wood effect designs,

the edge of the printed plank can be used in the lengthwise direction as a guide. Once the seam is cut, discard the waste material and check the final appearance.

Or

Using a straight edge and utility knife, cut off the selvage of the top sheet of the wood effect designs, using the edge of the printed plank in the lengthwise direction as the guide. Discard the waste strip. Then, using the cut edge as a guide, set a proprietary seam cutter to cut the lower sheet. Discard the waste strip and check the final appearance.

Once the seams have been dry cut, the vinyl sheets can be adhered to the substrate. Fold back all the sheets half way and apply an adhesive approved by Polyflor, following the adhesive manufacturer's instructions and recommendations.

Working from the centre of the room, fold the sheets back into their original position, using a rolling motion to reduce the risk of trapping air. Using a 68kg roller starting in the width direction, roll the floor to expel any air bubbles and ensure good contact with the adhesive, substrate and the back of the sheet vinyl. Repeat in the lengthwise direction. Repeat the whole rolling process approximately 4 hours later.

5.2 WELDING THE SHEET

There are two methods of welding that are recommended for heterogeneous vinyl sheet floorcoverings with a transparent wear layer/print construction.

5.2.1 Hot Welding

Once the adhesive is cured, normally after 24

hours, the seam can be grooved out. This can be done either manually by using a hand groover or mechanically using a power grooving machine. The groove should not be deeper than 2/3rds thickness of the wear layer for the U groove and 7/8ths thickness for the V groove.

A. Remove all dust and debris prior to welding.

B. Using an appropriate vinyl weld rod, test the weld fusion on a scrap piece of the material. Once you are happy with the heat settings and resultant weld, proceed to weld all the pre-grooved seams.

C. On completion, and whilst the weld is still warm, carry out the first trim. This should be carried out using a cable guide and spatula knife.

D. The final trim should be carried out once the weld has completely cooled and should be done using the spatula knife.

Note: The welding technique described will provide a very strong mechanical weld. Should



Figure 15 Cold welding

you require a much thinner line whilst at the same time providing a continuous surface, we suggest that in these instances, and using the technique described, only the wear layer be grooved out. This will result in a much narrower weld whilst still preventing ingress of dirt or moisture.

5.2.2 Cold Welding

Once the seam has been accurately cut, remembering that this type of welding should not be considered as gap filling, the seam can be welded.

A. *Cover the seam with masking tape or similar to prevent any excess welding liquid coming into contact with the vinyl surface.*

B. *Cut through the tape at the seam, using a utility knife with a sharp blade. Apply the welding liquid (Figure 15), as per the manufacturer's instructions, ensuring both hands are controlling the tube.*

Keep fingers away from the needle applicator.

C. *After approximately 10 minutes and once the welding liquid has cured, the masking tape can then be removed.*

Note: Any proud parts of the cured welding liquid can be left, as they will be removed with the effects of maintenance and traffic.

5.3 SUBFLOORS

In common with the installation of any type of flooring, the subfloor should not only be in sound condition, but also free of any contaminants, like oil, paint, preservative treatments or other forms of marking, such as a permanent marker pen.

Similarly, no markings should be applied to the back of heterogeneous flooring.

6 Installation of Rubber sheet



On receipt of rolls, check that colours correspond to those ordered, that the quantities are correct and that there is no damage. In particular, check that rolls are from one batch, if that was requested on the order.

On arrival at site, the rolls should be safely secured in an upright position and stored, together with the adhesive, at a minimum temperature of 18°C for at least 24 hours before laying.

Inflammable adhesives require special storage conditions. Contact the adhesive manufacturer or see current literature for details.

To achieve best results, site conditions should be as described in BS 8203. A working temperature of between 18°C and 26°C is required for at least 24 hours prior to, and during, the laying period and for 24 hours afterwards. Conditioning areas and laying areas should be of similar temperature, to prevent thermally induced dimensional changes.

In installations where underfloor heating is used, this should be switched off from 48 hours prior to installation until 48 hours afterwards. It should then be slowly brought

back up to the working temperature, a maximum of 27°C.

Adhesives capable of withstanding temperatures up to 27°C should be used. Where direct sunlight, sometimes in conjunction with underfloor heating, creates high surface temperatures on the floor, an approved epoxy or polyurethane adhesive should be used.

See Polyflor recommended adhesive listings.

The work area should now be prepared to receive the rubber sheet flooring. Ensure that all other trades have completed their work and removed all their equipment and materials. Remove all debris and sweep or vacuum the whole floor area. Check the condition of the subfloor and make good as necessary.

Stone or power grind any cementitious subfloor to remove any "nibs" or ridges. Remove any surface contaminants, which may affect adhesion. Sweep or vacuum again prior to laying.

If required by the contract, or if in doubt, check the moisture content of the subfloor and record the results and method used. Good lighting is essential.

It is important to note that commencement of work is deemed by many as acceptance of the site conditions as being suitable for laying floorcoverings.

6.1 LAYOUT OF RUBBER SHEET

The architect may have provided a drawing showing the direction in which the material should be laid. In this case, lay the rubber sheet as directed. If the architect has left this to the discretion of the flooring contractor, it is

advisable to show at the tender stage in which direction the material will be laid and state that your estimate is based on this. Always pay particular attention to where seams will fall, avoiding such occurrences as seams in the centre of doorways. If large windows are installed, minimise the effect of the joints by laying towards the window.

6.2 SLABBING THE RUBBER SHEET

Polyflor recommends that all sheet rubber flooring be rolled out face upward, taking care not to damage the surface, and cut approximately to size. Allowance of at least 75mm should be made at the ends for trimming in. Ideally, the slabs should then be left overnight, and preferably for 24 hours, to condition at a minimum temperature of 18°C.

6.3 FITTING THE SHEET

Place the first sheet in position next to the wall with the outer edge approximately 15mm from the nearest point. Adjust the lie of the sheet so that the inner edge is parallel with the axis of the room (Figure 16).

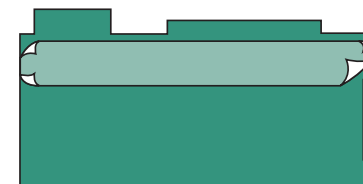

Figure 16 Lining up the first sheet

Depending upon the depth of the recesses, either a bar scriber or a pair of scribes should be used to trace the profile of the wall. The scribes should be set to allow for the deepest recess or rake of the wall. Holding the scribes vertically and square to the rubber edge, trace the wall profile onto the face of the sheet

(Figure 17). With this method, all irregularities of the wall will be accurately reproduced onto the surface of the rubber sheet. If, because of the colour or decoration, the scribed line is difficult to see, rub suitably contrasting chalk dust into the line to highlight it.



Figure 17 Scribing the wall profile

Ease the sheet away from the wall and, using a hook blade trimming knife, cut off the excess rubber to the scribed line. Slide the sheet back against the wall and check the fit, making any minor adjustments as necessary.

When satisfied that the fit on the first edge is correct, use a pencil to trace the opposite edge onto the subfloor (line A-B in Figure 18).

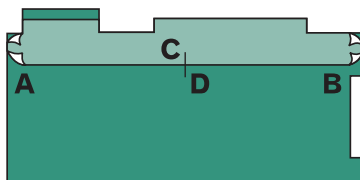

Figure 18 Marking the position

In the centre of the room, draw a line on both the rubber and subfloor square to the main axis of the sheet (line C-D in Figure 18).

Keeping the inner edge of the rubber on line A-B, slide the sheet back to clear the wall at one end of the room.

Set the scribers to the distance now between lines C and D (Figure 19). Trace the end wall profile and cut to fit as described in preceding paragraphs.

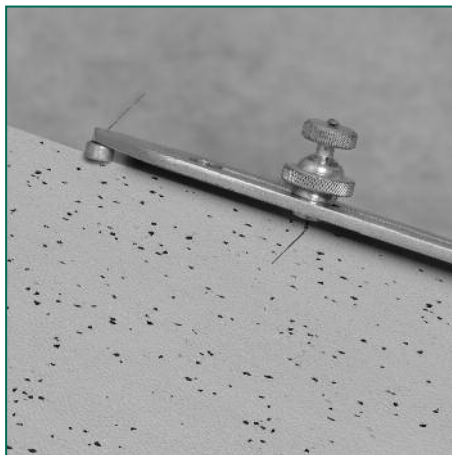

Figure 19 Setting the scriber

Repeat for the other end of the sheet. Once completed, the whole sheet - when slid back into position - should fit the wall profiles exactly.

Note: If fitting to set-in coving, the same principles apply but a reverse scriber must be used to trace the toe onto the sheet. It is normal to free hand cut to the coving, allowing 12mm overlap for final trimming in.

6.4 FITTING SUBSEQUENT LENGTHS

Place the second length parallel to the first length, with a maximum 25mm overlap along the adjoining edges. On the opposite side, trace the edge along the whole length onto the subfloor. In the middle, draw a line C-D at right angles to the main axis, as described previously.

Using the longitudinal line as a guide, slide back the sheet from the end wall and fit as described in Section 6.3. Repeat for the opposite end. Repeat the sequence for all remaining lengths. On the final length, which abuts the opposite wall, fit as described for the first length Section 6.3.

6.5 CUTTING IN THE SEAMS

If welding is necessary (see section 6.10), seam cutting, grooving and heat welding are described in detail in Section 12.

Note: The seams should be cut before the adhesive is spread.

6.6 ADHERING THE SHEET

Prior to adhering the rubber sheet, it is important to read and understand the adhesive manufacturer's instructions, recommendations and safety advice. You need to know the hazards and limitations of the adhesive, especially the open time.

Never spread more adhesive than can be laid within the open time.

Polyflor does not recommend any method of adhesive application, such as rolling or spraying, which cannot guarantee the spread rate.

Wherever practical, start with central strips first, as these are usually easier, having fewer recesses or awkward fittings.

A. Fold back the sheet to just over half its length, making sure the remaining half retains its position.

B. Spread the adhesive using a notched trowel of the correct size, as recommended by the adhesive manufacturer. Maintain the correct size of notch at all times, recutting as necessary as work progresses.

C. When the adhesive is ready to accept the floorcovering, roll the rubber sheet back into place, taking care not to twist the roll or trap air bubbles.

D. Check that seams are without gaps and remove any excess adhesive.

E. Roll with a 68kg articulated floor roller, firstly in the short direction, then in the long. In corners and other awkward areas, use a hand roller.

F. Repeat over the whole floor until all the sheets are adhered.

G. Roll the whole area thoroughly again, between one and four hours later.

6.7 PREMATURE TRAFFICKING OF NEWLY LAID FLOORS

Early trafficking may disturb the adhesive bond and weaken it, resulting in the associated problems of tracking, indentation, debonding etc. After the rubber sheet has been installed, only light foot traffic should be allowed for at least 24 hours. Where liable to be subject to heavy trafficking, the rubber should be protected with hardboard, plywood or a proprietary protector for at least 48 hours. Ensure that if there is any printing on the protector, it is not left in contact with the rubber surface as it can stain.

6.8 PATTERN TEMPLATE METHOD

Areas which call for a considerable amount of fitting around obstacles, or which are too confined to lay down a sheet for fitting by normal methods, can be dealt with by templating the floor in felt paper.

Note: In new buildings, it may be worthwhile discussing installation with the main contractor who may agree to fitting WCs, sinks etc. after the rubber has been laid.

A. *Dry fit the area with felt paper, leaving a gap of 15mm to 20mm around obstructions.*

B. *Draw around the fittings using a compass set at 25mm. Mark the template "This Side Up".*

C. *Place the rubber sheet in a larger area with the face uppermost. Place the template on top ensuring the direction of decoration is correct. Secure the template firmly in position and, with a pair of scribes set at 25mm, mark the position of all obstacles using the template as a guide.*

D. *Using a sharp trimming knife, cut the rubber sheet to the scribed lines and fit into position.*

Do not use the felt paper template as an underlay.

6.9 SITE FORMED COVERED SKIRTING

Polyflor sheet rubber flooring, in conjunction with a rubber cove, can be used to create site formed covered skirting. In hospital corridors or office complexes etc, a contrasting colour can be used for decoration or identification.

A. *Adhere the sections of cove former using a contact adhesive.*

B. *Use a mitre-block to accurately cut internal and external corners. Only adjust for length on straight cuts.*

C. *To prevent a difficult fit, and potential weak spot near doorways, cut away the back edge of the cove former on a taper for 150mm so that there is minimal cove former near the doorway. Warming the cove former may help enable the shape to be formed but do not use a naked flame.*

6.10 WELDING OF RUBBER SHEET

Welding of rubber sheet is not a prerequisite in most installations. However where there is heavy wet cleaning or where due to hygiene requirements a continuous smooth surface is demanded, the joints should be heat welded using the recommended weld rod.

Installation of Rubber tiles



On receipt of tiles, check that colours correspond to those ordered, that quantities are correct and there is no obvious damage. In particular check that tiles are from one batch, if that was requested on the order. On arrival at site, the tiles should be stored, together with the adhesive, at a minimum temperature of 18°C for at least 24 hours before laying. The tiles should be off-loaded from the pallet and stacked no more than five boxes high during the conditioning period.

Inflammable adhesives require special storage conditions. Contact the adhesive manufacturer

or see current literature for details.

To achieve best results, site conditions should be as described in BS 8203. A working temperature of between 18°C and 26°C is required for 24 hours prior to, and during, the laying period and for 24 hours afterwards. Conditioning areas and laying areas should be of similar temperature, to prevent thermally induced dimensional changes.

In installations where underfloor heating is used, this should be switched off from 48 hours prior to installation until 48 hours

afterwards. It should then be brought slowly back up to the working temperature, a maximum of 27°C. Adhesives capable of withstanding temperatures up to 27°C should be used. Where direct sunlight, sometimes in conjunction with underfloor heating, creates high surface temperatures on the floor, an approved epoxy or polyurethane adhesive should be used.

The work area should now be prepared to receive the rubber tiles. Ensure all other trades have completed their work and removed all their equipment and materials. Remove all debris and sweep or vacuum the whole floor area. Check the condition of the subfloor and make good as necessary. Stone or power grind any cementitious subfloor to remove any "nibs" or ridges. Remove any surface contaminants that may affect adhesion. Sweep or vacuum again prior to laying. If required, check the moisture content of the subfloor and record the results and method used. Good lighting is essential.

It is important to note that commencement of work is deemed by many as acceptance of the site conditions as being suitable for laying floorcoverings.

7.1 LAYOUT OF RUBBER TILES

Although many floor layers regard tiles as being easier to lay than sheet, the layout of the tiles can be critical to the success of the installation. The regular form of tiles, especially when laid in contrasting colours, can accentuate deviations in the building line, emphasising the need for detailed planning of the layout. Many floor layers start in the main doorway, believing that the initial impression

when entering a room is most important. However, working from the centre of the room and loose laying tiles to check the layout will make the final appearance correct from any viewpoint. This is especially important where a geometric design is incorporated into the floor.

7.2 MEASURING AND MARKING OUT

A. Measure the room to be laid in both directions, including any alcoves etc.

B. Mark a chalk centreline A-B ensuring that it is square to the wall with the doorway.

C. Loose lay tiles away from the centreline A-B and check that no small strips will have to be laid at the perimeter of the room. If small strips do result, move the centreline in either direction, keeping it parallel to the line A-B, so that the perimeter tiles will only require a small piece cutting off.

D. Mark a chalk centreline C-D, ensuring that it is square to the line A-B. Check squareness with a large square, trammels or geometrically.

E. Loose lay tiles away from the centreline C-D and check that no small strips will have to be laid. Adjust centreline C-D as described for A-B. In Figure 20, by moving the centreline C-D towards the door, tile 6 would only require a small amount to be trimmed off, as would tile 8 on the opposite wall.

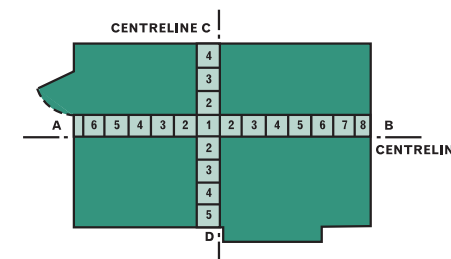

Figure 20 Laying out rubber tiles

7.3 SPREADING THE ADHESIVE

If the subfloor is porous, it should be primed using a primer compatible with the adhesive, as recommended by the adhesive manufacturer.

The amount of adhesive that can be spread at any one time depends upon the prevailing site conditions, such as temperature, humidity and throughflow of air - all of which affect the open time of the adhesive.

Adhesive manufacturers provide details of the open time, and their instructions should be followed. Ideally, the floor area should be divided into workable sections, leaving the perimeter tile areas unadhered until the main body of the floor has been laid.

7.4 ADHERING THE MAIN FIELD OF TILES

Ensure the backs of the tiles are free from dust prior to laying. This can be done whilst waiting for the adhesive to "go off". Once the adhesive is ready to accept the tiles, place the first tile at the starting point, which is the intersection of the two centrelines. Press well down in the centre of the tile and then run a thumb around the edge, ensuring all air is expelled.

Place the next tile in position, alternating the colour if necessary, and proceed down the centreline, laying two tiles wide i.e. one tile either side of the centreline. It is essential to keep the tiles exactly on the centreline.

When using "high tack" adhesives such as contact adhesive, take care not to twist or distort the tile whilst laying. If the tile is stretched, its dimensional stability will eventually return it to its original shape and the adhesive bond will be broken.

Repeat the sequence along the centreline at

right angles to the first. Then, working from the completed centrelines, finish the section taking care that tile bond is maintained throughout.

Any excess adhesive should be removed as work proceeds. When a section has been laid, except for the perimeter, it should be thoroughly rolled in both directions with a 68kg articulated floor roller. Repeat for each section until the main field of tiles has been laid.

7.5 CUTTING THE PERIMETER TILE

Two techniques are commonly used for cutting perimeter tiles. The choice is mainly dependent upon the run out of the wall.

7.5.1 Overlapping Method

Used when there is little or no run out of the abutting wall.

A. Place the tile to be cut exactly over the last tile laid, ensuring the colour is correct.

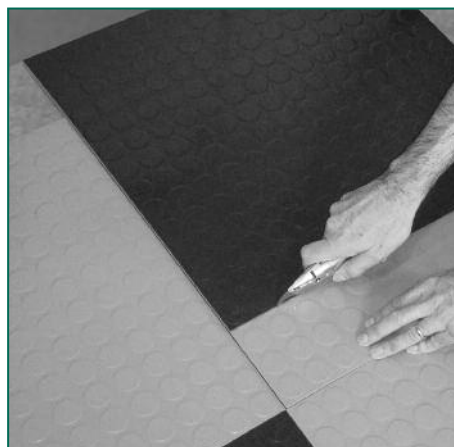

Figure 21 Measuring using an overlapping tile

B. Place another full tile on top of the tile to be cut, with its "top edge" against the wall (Figure 21).

C. Scribe a line onto the tile to be cut, using the "bottom edge" of the top tile as a guide.

D. Cut the tile to the scribed line, loose lay into position and check the fit. Repeat along the whole wall.

7.5.2 Scriber Method

Used when the wall run out is quite severe or when the wall profile cannot be picked up using a straight edge.

A. Place the tile to be cut exactly over the last tile laid ensuring the colour is correct.

B. Set the bar scriber to the size of the tile being laid.

C. Trace the profile of the wall onto the tile to be cut, ensuring the bar scriber is kept upright and square to the edge of the tile. Cut the tile to the scribed line, loose lay into position and check the fit. Repeat along the whole wall.

Note: Both the overlapping and scriber methods can be used to fit around projections such as door frames. Similarly, a template can be made or templating guide containing movable pins used for awkward shapes.

7.6 ADHERING THE PERIMETER TILES

Once a wall edge has been fitted and loose laid, turn all the tiles inward so as not to lose their position. Spread the adhesive right up to the edges. When the adhesive has lost sufficient moisture, lay the perimeter tiles. Wipe up excess adhesive as work progresses. Roll well with a 68kg articulated roller. Use a small hand roller in areas that are inaccessible. Repeat the process for all four walls. Finally, the whole floor should be given a second rolling, approximately one to four hours later.

7.7 INSTALLING TILES IN LARGE AREAS

The procedure for laying Rubber Tiles in large areas is identical to that for laying vinyl tiles, as described in Section 4.7.

8 Electro Static Dissipative (ESD) floorcoverings



The Polyflor ESD family of vinyl floorcoverings consists of products which are designed to meet specific resistance requirements. The terminology used to describe the various categories was changed in 1999, as the IEC brought together the various electronics industries to ensure that the same terminology is used by all parties.

Antistatic

These products do not accumulate static charges above 2.0 KV and are classified as 'Antistatic' when tested to EN1815. For specialist application where there is a requirement to dissipate the charge, see Polyflor ESD product ranges.

Static Dissipative (SD)

These products when tested to the test methods identified in our literature have a resistance to earth between 1×10^6 and 1×10^9 ohms.

Electrostatic Conductive (EC)

These products when tested to the test methods identified in our literature have a resistance to earth between 5×10^4 and 1×10^6 ohms.

Polyflor Royal Ordnance Factory (ROF)

These products when tested to the test methods identified in our literature have a resistance to earth between zero and 5×10^4 ohms.

8.1 SPECIFYING THE CORRECT PRODUCT

The Polyflor ESD family of products is designed to minimise or eliminate the risk of Electro Static Discharge (ESD) and it is essential that the correct product be selected for the intended application. An electrical performance specification must be identified at the outset. This will not only stipulate the maximum and minimum electrical resistance requirements of the installed floor, but will also identify the method of test, the electrodes to be used, the method of measurement and the testing environment.

From this information, the correct Polyflor ESD product can be identified, taking into account both the electrical performance and the method of installation. Whenever specifying a Polyflor ESD vinyl floorcovering, Polyflor strongly recommends that you discuss your requirements with our Customer Technical Services Department. They will advise on which products are best suited for the particular application, and where no specification has been identified, will advise on the specifications used in similar installations/industries.

8.2 ISOLATION OF SUBFLOOR

The electrical conductivity of a solid subfloor can vary greatly, and as a result the installed floor may have resistances lower than the minimum stated in the specification. Cementitious underlayments provide an isolating barrier of known resistance beneath the vinyl floorcovering.

Polyflor recommends that all solid subfloors should be covered with a cementitious underlayment which must be at least 3mm thick. The choice of underlayment is dependent

upon the end use location, and consideration should be given to such properties as point load resistance and protein content. The underlayment should be allowed to dry prior to the application of the floorcovering.

Polyflor accepts no responsibility for non-conformance due to the resistance of the installed floor being below the minimum specified, if an isolating barrier has not been used.

Note: Suspended timber subfloors are not conductive and do not require an isolating barrier.

8.3 CONDUCTIVE ADHESIVES

Polyflor recommends the use of Polyflor conductive adhesive for all Static Control floorcoverings and Polyflor contact adhesive for earthing strips. If alternative adhesives are used, they must be recommended by the adhesive manufacturer and approved by Polyflor.

Note: Access panels vary from manufacturer to manufacturer, both in design, materials used and electrical performance specification. We recommend in these instances that you discuss your individual requirements with your panel supplier or alternatively with our Customer Technical Services Department.

8.4 CONDUCTANCE TO EARTH

Installing an earthing system is a prerequisite for ESD floors. This gives the end user the option to test to earth should there be a requirement at a later stage. Secondly, it improves the conductance of the installed floor to a known earth via a controlled path.

The choice of material used for the earthing

system can be brass, copper or stainless steel and should be nominally 50mm wide and 0.1mm thick. However, the width is only important for the "Conductive" floorcovering.

When an earthing system is installed, Polyflor recommends the use of at least two connections to earth, the second as a security back-up should the first be disconnected or damaged. Connection of the earthing system to the building earth is normally carried out by a qualified electrician and not the flooring contractor.

8.4.1 Polyflor Static Dissipative (SD) Floorcoverings

The earth strip is laid 150mm from one side of the room, in the same direction as the vinyl sheets are to be laid. This strip is connected to a known earth (Figure 22).

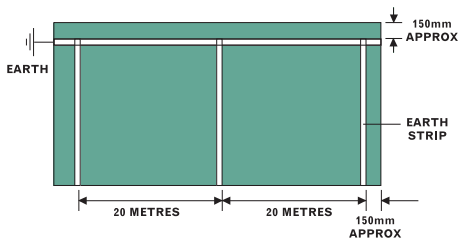

Figure 22 Earthing strip layout

A second strip is laid at 90° to the first, 150mm from the edge and running across the full width of the room. Further strips are laid at 20 metre intervals as determined by the size of the room.

8.4.2 Polyflor Electrostatic Conductive (EC) Floorcoverings

A length of earth strip is adhered to the isolating underlayment and connected to a known earth. The strip need only extend along the floor for 150mm (Figure 23).

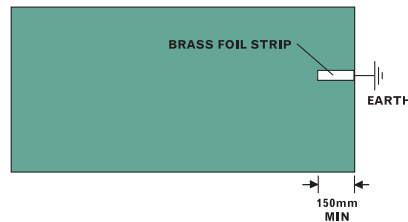

Figure 23 Earth connection

8.4.3 Conductive ROF

With this type of flooring, an earthing grid of the correct size strip (50mm wide, 0.1mm thick) is essential. The strips should be laid to form 600mm² grids across the floor, the perimeter strips being 150mm from the wall (Figure 24). At an appropriate point the strip should be connected to a known earth. It is important that the layout of the grid is confirmed with the end user as there are variations in the requirement for some military specifications.

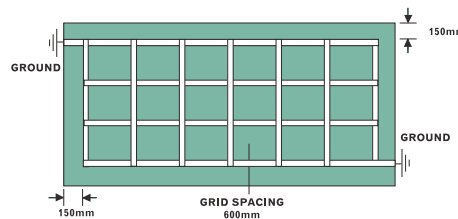

Figure 24 Earthing strip layout

8.5 INSTALLATION METHODS

The basic techniques for installation of Polyflor ESD floorcoverings are the same as described for standard vinyl sheet and tile in Sections 3 and 4 respectively. However, there are a number of important differences:

8.5.1 ESD Vinyl Sheet

Polyflor ESD vinyl sheet should be installed by the double drop method. This is because the

conductive adhesive contains carbon, which results in low tack.

Once the adhesive has been spread, the vinyl sheet is laid into it and pressed all over to ensure an even transfer of adhesive. The vinyl sheet is then folded back and left until the adhesive becomes tacky. When the adhesive is tacky, the vinyl sheet should be accurately re-laid, ensuring it does not twist or trap air bubbles. Seams must be without gaps and any excess adhesive should be removed as work proceeds. The vinyl sheet is then rolled with a 68kg articulated floor roller in the short direction first, then the long, and the rolling repeated between one and four hours later.

8.5.2 ESD Vinyl Tiles

Polyflor ESD vinyl tiles are installed by the same method as standard vinyl tiles - the single stick method. The grid layout for static control tiles is the same as for sheet vinyl, as described previously.

Note: ESD vinyl tiles must always be heat welded. See Section 12.

8.6 SPECIAL PRECAUTIONS

Special precautions must be taken with the following products:

8.6.1 Electrostatic Conductive (EC) Floorcoverings

Pipes or metal projections (e.g. metal gullies, door spring plates etc.) must be insulated from the EC floorcovering and free from conductive adhesive. The following method of installation is recommended.

The EC floorcovering should be cut 50mm short of any pipe or metal fixture. This infill area should be laid with a suitably coloured

standard Polyflor sheet vinyl, adhered with a non-conductive adhesive. This infill piece should then be welded to the ESD floorcovering with a standard weld rod.

8.6.2 Conductive Floorcovering

Polyflor Conductive does not provide protection from a short circuit on a 240/250 volt mains. Where this material is installed, all electrical equipment and switches must be located outside the building. No portable electrical tools should be used inside, unless earth leakage circuit breakers are fitted to the switchgear.

8.7 HEAT WELDING

All Polyflor ESD floorcovering installations (excluding access panels) must be heat welded. Ideally, the floor should be left for a minimum of 24 hours before welding the joints. This will prevent adhesive bubbling up into the seams when heat is applied. For details of heat welding, see Section 12.

Note: Conductive welding rod is not a requirement with Polyflor ESD floorcoverings.

8.8 TEST METHODS

Worldwide, there are a great many test methods for electrical grade floorcoverings and, with rapid developments in the electrical and electronic industries, standards are constantly being reviewed. To ensure that the floor is tested to the latest specification, it is suggested that the architect or specifier should obtain a copy of the test method and requirements from the local office of the National Standards Authority. It should then be attached to the specification prior to the ordering of materials and installation of the floor. If a test method is not specified, the

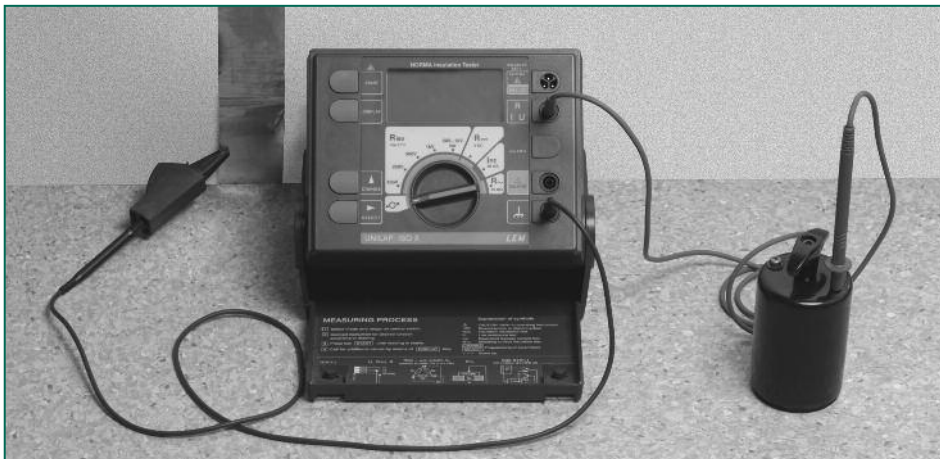

Figure 25 Test electrode

following procedure is recommended and approved by Polyflor.

8.8.1 Test Procedure (BS 61340 -4-1)

The electrical testing of the floor must be carried out with an insulation tester, operating at 100 volts D.C.

8.8.2 Test Electrodes (BS 61340 -4-1)

The electrode consists of a brass cylinder 65mm in diameter, weighing approximately 2.5 kg. A screw connector attaches the test lead to the top surface of the cylinder. On the underside is attached a round rubber pad - of 5mm thickness and 65 mm in diameter - which has been covered with thin metal foil (Figure 25).

8.8.3 Test Conditioning

It is essential to condition the floor prior to testing. The floor should be cleaned (see Section 19.10) at least 24 hours before testing, and then conditioned for 24 hours at 40-60% RH and 20-25°C.

Note: The relative humidity and temperature are only critical for Polyflor Static Dissipative floorcoverings.

8.8.4 Test Method (BS 61340 -4-1)

One electrode should be placed on the floor. The second connection should be made to the earth point, the resistance being measured between the electrode and a known earth. One test should be made for every 2 square metres of flooring. The test may not be reliable if made within 24 hours of the flooring being laid or cleaned.

8.8.5 Testing to a Grid

The procedure of always testing the same points "on a grid" is not recommended. The whole floor should meet the specification, not just selected points. To ensure continual performance of the whole floor, it should be periodically tested at random points.

8.8.6 Test Results

Polyflor ESD floorcoverings are manufactured to specific levels of conductance and are tested, prior to despatch, in laboratory conditions.

On-site testing not only takes into account the floorcovering but also the adhesive, the subfloor and the environment. When installed

and tested in accordance with the instructions laid down by Polyflor and detailed in this manual, the electrical resistance should be as follows:

EARTH TEST RESULTS		
	MINIMUM AVERAGE	MAXIMUM AVERAGE
Static Dissipative	1 x 10 ⁶ ohms	1 x 10 ⁹ ohms
Electrostatic Conductive	5 x 10 ⁴ ohms	1 x 10 ⁶ ohms
Conductive ROF	Zero ohms	5 x 10 ⁴ ohms

The Customer Technical Services Department offers, for a fee, a finished installation testing service - to ensure that the whole installation meets the specification requirements.

A Certificate of Conformance is issued on completion. We recommend that you discuss your testing requirements with our Customer Technical Services team, to ascertain staff availability etc.

8.9 STATIC CONTROL SYSTEMS

In many instances, a Polyflor ESD floorcovering is sufficient to give the necessary control, but in highly static-sensitive areas, additional precautions may be necessary.

These include:

- Dissipative clothing and footwear
- Wrist and heel straps
- Special work stations
- Dissipative packaging and sealing
- Ionisers and humidity controllers

9 Installation of vinyl Wallcoverings



On receipt of rolls, check that colours correspond to those ordered, that quantities are correct and that there is no damage. In particular, check that rolls are from one batch, if that was requested on the order. On arrival at site, the rolls should be safely secured in an upright position and stored, together with the adhesive, at a minimum temperature of 18°C for at least 24 hours before laying.

Inflammable adhesives require special storage conditions. Contact the adhesive manufacturer or see current literature for details.

To achieve best results, site conditions should be as described in BS 8203. A working temperature of between 18°C and 26°C is required for at least 24 hours prior to, and during, the laying period and for 24 hours afterwards. Conditioning areas and laying areas should be of similar temperature, to prevent thermally induced dimensional changes.

9.1 PREPARATION

The wall surface must be smooth, sound, clean and dry. All paint, oil, grease, excessive dust and any other contaminants liable to impair adhesion must be removed, prior to

application of the wall-cladding.

Plaster and plasterboard are ideal substrates.

Note: In order to achieve a Class 'O' fire rating as defined in the UK Building Regulations for vinyl to walls and ceilings, the substrate should be either bare plaster or plasterboard composition.

9.2 INSTALLATION

A. Prime the areas of plastered wall with a primer, as recommended by the adhesive manufacturer, and allow to dry completely.

B. Mark the first vertical line on the wall using a plumb line. Use only pencil for marking the wall and vinyl.

C. Cut the Polyclad to size, allowing a small amount for cutting in.

D. Apply a recommended contact adhesive 150mm wide at the top edge of the wall, adjacent to the ceiling and corresponding to all pressure points, such as external and internal angles and coved radiuses.

E. Prior to placing the vinyl into position, and to give extra support, it will be necessary to apply a recommended contact adhesive to the back of the vinyl, approximately 150mm deep at the top edge, and corresponding to the pressure points, such as external and internal angles and coved radiuses. Allow to become touch dry before applying Polyclad.

F. Roll up the vinyl with the face innermost, and with the decoration running either vertically or horizontally, dependent on the size of roll, wall and application preference.

G. Spread a further coat of recommended adhesive as directed by the adhesive

manufacturer, to the prepared wall surface.

H. When ready, and working to the vertical line on the wall, apply the vinyl to the line, ensuring there are no ripples or run-outs.

I. Roll the entire area using a flooring grade hand roller, from the centre outwards, to exclude air. A second rolling will be necessary.

9.3 SUGGESTED INSTALLATION METHOD

9.3.1 External angles

A. To enable the wall-cladding to be formed around external corners, it will be necessary to fit and adhere 'Polyflor Ejecta EFA75' cornercap profile to all external corners.

B. Fit and adhere the EFA75 cornercap profile to all external corners. Use a recommended contact adhesive to secure the EFA75, and press firmly.

C. When all the cornercap profile is fixed, apply contact adhesive to the surface and to 150mm either side of the corner edge. Allow to become touch dry before applying Polyclad.

D. Apply contact adhesive to the corresponding area on the back of the Polyclad and allow to go touch dry before installing.

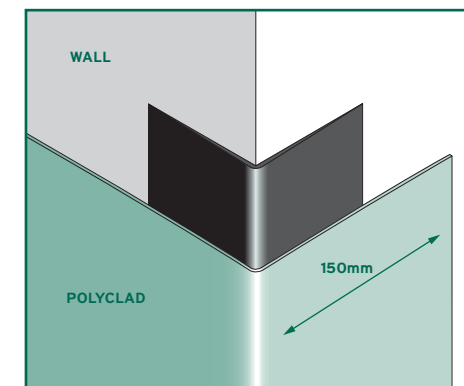

Figure 26 EFA75 Cornercap profile

9.3.2 Internal angles

A. To enable the wall-cladding to be formed around internal corners, it will be necessary to fit and adhere 'Polyflor Ejecta' cove former to all internal corners.

B. Fit and adhere the cove former to internal corners and at the junction of the ceiling and top of the wall. Use a recommended contact adhesive, and press firmly. First, fit the mitres in the corners, and at the junction of the ceiling and top of the wall. For ease of use, short lengths of approximately 300mm are recommended.

C. When all corners are completed, fit and adhere the longer straight lengths, using the same method. When all the cove former is fixed, apply contact adhesive to the face of the cove former and 150mm either side of the corner edge. Allow to become touch dry before applying the Polyclad.

D. Apply contact adhesive to the corresponding area on the back of the Polyclad and allow to go touch dry before installing.

E. All joints should be heat welded on completion, allowing at least 24 hours after fitting for sufficient moisture to dry out of the adhesive. Finally, trim welds when cold to prevent sunken welds.

Note: Do not attempt to take large pieces of wall-cladding around corners. The walls may not be vertical or square, and can cause a runoff or possible rucking of the vinyl at the next seam. In these instances, work to 150mm around the corner.

For information regarding adhesives, contact Polyflor Customer Technical Services on +44 (0)161 767 1912.

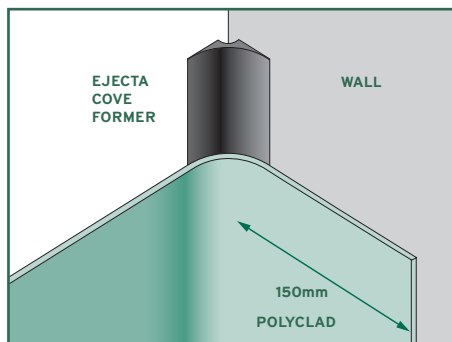

Figure 27 Ejecta cover former

10 Installation of Accessories



The Polyflor Ejecta ranges of flooring accessories are PVC extrusions designed for use with most vinyl floorcoverings, especially the Polyflor and Polysafe ranges. The Ejecta range includes set-in coved skirtings, sit-on coved skirtings, cove former, capping strip and CT strip as well as the weld rods covered in Section 12.

On arrival at site, the accessories should be checked, stored and conditioned, together with the adhesive, as described for vinyl flooring.

Note: Inflammable adhesives require special storage conditions. Contact the adhesive manufacturer or see current literature for details.

10.1 PREPARATION

Ensure that all surfaces are firm, dry and free of dust, grease and oil. Fair faced brickwork or blockwork should have a latex skim coat applied, as this provides a smooth, firm surface of known porosity which will minimise adhesive usage and improve adhesion. Alternatively, 4mm thick plywood can be cut into appropriate width strips and then nailed to the blockwork to provide a smooth surface onto which the skirting can be fitted.

All painted surfaces must be stripped back and wire brushed to remove all traces of paint.

Always read carefully and observe the adhesive manufacturer's instructions. Pay particular attention to use of solvent-based adhesives, especially regarding ventilation and possible sources of ignition.

10.2 MARKING OUT

Accurate marking out is essential to minimise adhesive usage and to prevent excess adhesive spoiling decorations. Marking out may be done by a variety of methods including scribes, height gauges and section templates. All fitting work must be carried out accurately prior to application of adhesive, as movement afterwards is restricted. Adjustments for length should always be made on straight joints - never on mitred sections - unless the length of the wall does not permit this.

When using sit-on coved skirtings around external corners, a joint can be avoided by grooving out some of the material from the back using an Exacto cutter, and then warming the coving with a hot air gun. It should be noted that the toe will be curved rather than right angled when the coved skirting is installed.

10.3 ADHESIVE APPLICATION

For use in well ventilated areas where there is no risk of ignition of the organic vapours.

This system is based upon a solution of polychloroprene rubber in organic solvents. Application is as follows:

- A.** *If the surface is slightly porous, apply a suitable primer and leave to dry for 24 hours.*
- B.** *Then, apply adhesive equally to the section and to the surface to which it will be attached, using a flat spreader. Leave until the adhesive is dry to the touch.*

As a guide, adhesive coverage should be approximately 5 litres per 100 metres on 100mm high Ejecta section, dependent upon the porosity of the surface and the thickness of applied coats.

10.4 ADHERING THE ACCESSORIES

When the adhesive is dry to the touch, press the section firmly against the other surface, placing it accurately first time. The section should not be removed or subjected to lateral force if good adhesion is to be assured. Set-in coved skirtings are applied before the floor finish is laid and sit-on coved skirtings are applied after the floor finish is laid.

Inlaid designs and borders



Polyflor Expressions inlaid motifs and border designs are manufactured under strictly controlled conditions to produce the close-fitting pieces which make up the design. To duplicate the close-fitting on site, it is important to ensure the design is correctly conditioned prior to laying.

The Polyflor Expressions design should be removed from its packaging and laid on a flat surface and conditioned, together with the rolls of vinyl or vinyl tiles and water-based adhesive, at a temperature of at least 18°C (64°F) for a minimum of 24 hours prior to and during

installation, and at least 24 hours afterwards.

11.1 WELDING - DRY AREAS

Welding is not a standard requirement of Polyflor Expressions and should only be carried out on the most simple of designs such as squares, circles etc.

Where border designs are to be incorporated into the floor, consideration as to whether welding would affect the definition of the border lines, thus affecting the finished appearance, should be given.

11.2 WELDING - WET AREAS

Where motifs/designs are to be laid into wet areas, either an approved epoxy resin or polyurethane adhesive should be used, or the motifs/designs welded after consideration of the effect on the finished appearance.

11.3 INSTALLATION INSTRUCTIONS FOR MOTIFS WITH A RECTANGULAR OUTER FRAME

A. As normal practice, slab the lengths and fit and loose lay the main area.

B. Place the Polyflor Expressions motif into position on top of the loose laid material and secure with masking tape to prevent movement.

C. Trace the top and right hand side of the rectangular edge frame with a knife and remove the motif. Also trace a diagonal line from the start point to the finish point, forming a triangle. Cut through and remove triangle waste.

D. Reposition the motif so that it butts up tightly to the two newly cut edges. The two remaining sides can now be traced and cut through.

Note 1: By cutting in the rectangle in two stages, a tighter joint will result.

Note 2: Always trace and cut through in one direction for best results.

E. Adhere the motif using a correctly notched trowel and approved adhesive, and roll with a 68kg roller.

F. Remove clear film from the face of the motif and remove any adhesive traces. Any minor adjustments to the motif should be made whilst the adhesive is wet.

G. Fold back the main length(s) away from the motif, and adhere as above. Ensure when placing

the material into the adhesive that the joint(s) abutting the motif are tight, and roll with a 68kg roller.

H. Turn back the other half of the length and adhere and roll as before.

11.4 INSTALLATION INSTRUCTIONS FOR MOTIFS/DESIGNS WITHOUT A RECTANGULAR OUTER FRAME

Where the motif is a simple outline, it is possible to produce an acceptable appearance by carefully tracing and cutting around the outer edge. The following procedure should be adopted. For intricate outlines, an outside rectangular frame should be incorporated.

A. As normal practice, slab the lengths and fit and loose lay the main area.

B. Place the Polyflor Expressions motif into position on top of the loose laid material and secure with masking tape to prevent movement.

C. Turn back the clear adhesive film approximately 25mm away from the outside edge of the motif and carefully trace around half of the motif shape. Remove the motif and cut a straight line from starting point to finishing point. Cut through and remove this waste half piece.

D. Reposition the motif so that it butts up tightly to the newly cut edge and secure with masking tape to prevent movement.

E. Carefully trace around the other half of the motif and cut through.

Note: Always trace and cut through in one direction for best results.

F. Adhere the motif using a correctly notched trowel and approved adhesive, and roll with a 68kg roller.

G. Remove clear film from the face of the motif and remove any adhesive traces. Any minor adjustments to the motif should be made whilst the adhesive is still wet.

H. Fold back the main length(s) away from the motif and adhere as above. Ensure when placing the material into the adhesive that the joint(s) abutting the motif are tight, and roll with a 68kg roller.

I. Turn back the other half of length and adhere and roll as before.

Polyflor Expressions designs are maintained in the same manner as the surrounding Polyflor vinyl floorcovering. (Full details are given in Section 19 of this manual).

11.5 INSTALLATION OF BORDERS

A. Measure and mark the subfloor, using chalk lines to correspond with the required border positions. Measure the main lengths required to fit inside the border, allowing approximately 25mm overlap.

B. Lay out the material so that it is overlapping the inner edge of the border chalk line.

C. Snap the chalk line over the top of the material to correspond with the inner border lines.

D. Using a knife and straight edge, carefully trace along the chalk lines and cut and remove the 25mm surplus. The material can now be folded back and adhered, taking care to retain a straight line around all outside edges. The area must then be rolled.

E. The border pieces now require positioning up to the newly-cut straight edges, and adhering. The clear film on the face of the border design should then be removed and any minor

adjustments to the border made whilst the adhesive is wet. The border can then be rolled.

F. The outer margin can now be fitted and adhered to the finished border.

12 Welding vinyl flooring



Polyflor strongly recommends that all Polyflor vinyl sheet and 608mm vinyl tile floorings are welded, this includes the internal and external joints when the vinyl sheet is site cove formed. Most specifications make welding mandatory, since it prevents ingress of dirt and bacteria into seams and provides a floor surface which is impermeable to water. However, welding will only aid maintenance of high standards of hygiene if it is executed correctly. The guidelines provided below should be followed carefully, since short cuts taken in welding create potential problems with seam failures.

12.1 HEAT WELDING

Heat welding of vinyl floorcoverings has been used successfully for many years and employs the technique of heating both the vinyl flooring and the vinyl welding rod to a sufficient temperature to melt and fuse them together.

The procedure is the same for both sheet and tile installation with the exception that the edge of the tiles do not require cutting in prior to grooving.

12.2 CORRECT TOOLS

Having the correct tools in good condition is a prerequisite of good heat welding. The tools

required are dependent upon preferred methods but as a guide the following are suggested:

- 2 metre rigid straight edge
- Straight and hook bladed knives
- Grooving tools - manual and powered
- Welding equipment - manual and automatic
- Spatula • Trimming guide
- Exacto trimming tools • Under scriber
- Feed roller • Chalk line
- Wire brush • Seam cutters

See also Section 14.

12.3 CUTTING IN THE SEAMS

Factory edges should never be butted together but should be overlapped and cut by one of the following methods:

12.3.1 Using Seam Cutters

Set the first cutter to the thickness of vinyl sheet. Using the factory edge as a guide, trim off 6mm along the length. Where it is not possible to use the seam cutter against the wall, or in other areas of restricted access, use a straight edge and straight bladed knife held squarely to the floor.

Set the second cutter to the thickness of vinyl sheet. Using the edge previously cut on the top sheet as a guide, cut through the bottom sheet. Remove the scrap piece of material.

12.3.2 Using an Under Scriber

Prior to overlapping the vinyl sheet, trim off the factory edge on the bottom sheet. This is best done by striking a chalk line, then - using a utility knife and straight edge - cut through and remove the scrap piece.

Overlap the top sheet and then trace the bottom edge onto the top sheet with correctly set under scribers. To highlight the scribed line,

rub some chalk dust into the surface. Trim the top sheet to the scribed line.

12.4 GROOVING THE SEAMS

Strike a chalk line along the overlap. Using a utility knife and straight edge, double cut the joint through both layers of material, ensuring that the knife blade is held squarely to the floor.

Prior to welding, some of the material must be removed from the seam, creating a groove that will accept the vinyl welding rod. Two shapes of groove can be cut:

1. A "U" shape - which leaves a semi-circular groove in the vinyl. This should extend into the vinyl for 2/3 of its thickness, up to a maximum of 2mm.
2. A "V" shape - which leaves a 60° triangular groove in the vinyl. This should extend into the vinyl for 7/8 of its thickness.

Note: The 'V' shaped groove has proven particularly suitable for embossed versions of Polysafe vinyl sheet floorcovering.

The groove on Acoustic and Sports flooring should only be cut in the vinyl wear layer. It should never be cut through to the PVC foam backing.

12.4.1 Manual Grooving

Place the centre of the grooving tool over the centre of the seam. Bring up the straight edge to touch the side of the cutter, and align the straight edge, maintaining an even distance from the seam (Figure 28).

Pulling the tool towards you, groove to the required depth. Move the straight edge as required and repeat until the whole seam is grooved. Sweep well to remove any dust and trimmings from the groove.



Figure 28 Grooving the seam

12.4.2 Powered Grooving

Set the blade to the correct depth of cut. Align the guides with the cut seam. Press the cutter in to the full depth of cut and then push forward following the cut seam. Use hand tools to complete grooves next to walls, skirtings etc. Sweep well to remove any dust and trimmings from the groove.

Never use a powered grooving machine with a standard blade on Polyflor safety vinyl sheet floorcovering. The silicon carbide and aluminium oxide particles will destroy the blade.

12.5 WELDING THE SEAMS

If wet set adhesive has been used, it is important, before commencing heat welding, to ensure that the adhesive has set sufficiently to prevent it bubbling up when heat is applied. If bubbling up occurs, it will adversely affect seam strength.

Prior to commencing welding:

- A.** Ensure the speedweld attachment is free of debris by cleaning with a wire brush.
- B.** Pre-heat the welding gun (setting 3 - 6 on a variable setting gun), ensuring that the nozzle is pointing upwards during this pre-heat period.
- C.** Try out the welding rod on a scrap of material to ensure the temperature is correct and that fusion is taking place. Adjust accordingly.



Figure 29 Applying the weld

When you are satisfied that the temperature is correct, you can proceed to weld the joint:

- D.** Place the welding rod into the speedweld aperture. Starting as close as possible to the end of the room, press the welding rod down into the groove with the speedweld attachment, the toe of which should be parallel to the vinyl surface. Pull the gun towards you whilst maintaining the downward pressure (Figure 29). Ensure the gun is kept square to the floor. With your spare hand, alternately check the weld security and that the welding rod is feeding freely.

- E.** Typically, you would start welding from the edge of the room towards the centre. At this stage, pull the gun away from the groove and cut off the welding rod. Using a spatula knife, trim off the excess welding rod and cut a tapering "V", approximately 25mm long, into the existing weld (Figure 30). Commence welding as before, from the opposite end of the room. Run out the weld into the pre-cut "V" and cut off the excess welding rod.

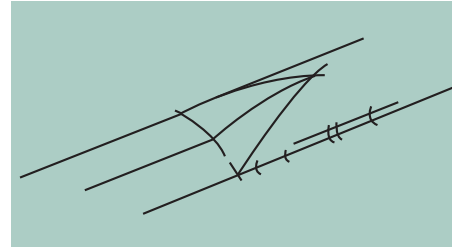

Figure 30 Weld joints

Where Ejecta set-in skirtings are used, the vertical joints and mitres are not hot welded. See Section 10.

It is important to ensure a constant rate of welding. Moving slowly will "burn" the vinyl and moving quickly will not fuse the welding rod. The finished width of the weld may also vary and detract from the appearance.

12.6 TRIMMING THE WELD

Prior to commencing, it is advisable to stone or hone the trimming spatula knife on one side only. This keen edge will make trimming easier and minimise the risk of "digging in". Trimming of the weld must be carried out in two stages. Failure to follow this procedure will result in dished welds which are prone to dirt pickup.

- A.** Place the trimming guide over the welding rod. Insert the spatula knife into the two lugs with the honed edge uppermost. Push the knife

forward and trim off the top layer of welding rod (Figure 31). This can be done whilst the weld is still warm. Trimming the weld speeds up the cooling time.

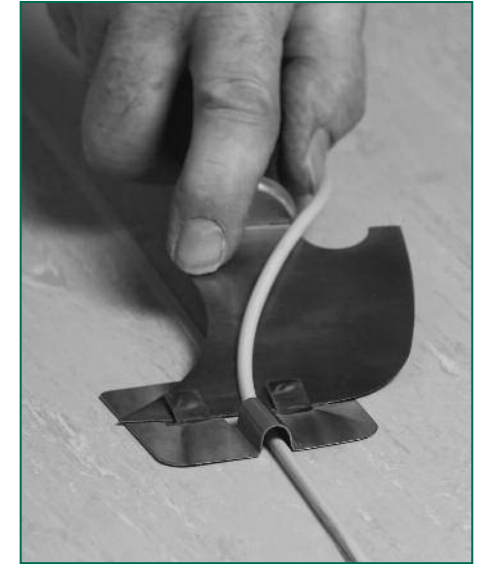

Figure 31 Trimming off the weld top layer



Figure 32 Final trim after the weld has cooled

B. *When the remaining weld has cooled to room temperature, the excess weld should be trimmed. The spatula knife, again honed edge uppermost, is used without the trimming guide. Keep as shallow an angle as possible between blade and floor to avoid the risk of "digging in" (Figure 32).*

Note: Polyflor foam backed vinyl sheet flooring is liable to compression and sometimes, even after the final trim, the weld is proud of the floor. In this case, use an Exacto cutter with a large circular blade to scrape away any high spots.

12.7 GLAZING THE WELD

Should a glazed finish be required this can be achieved with the speedweld attachment removed but still on the same heat setting, play the gun nozzle over the trimmed weld. Repeat over the whole length of the weld, keeping the gun moving constantly to prevent burning.

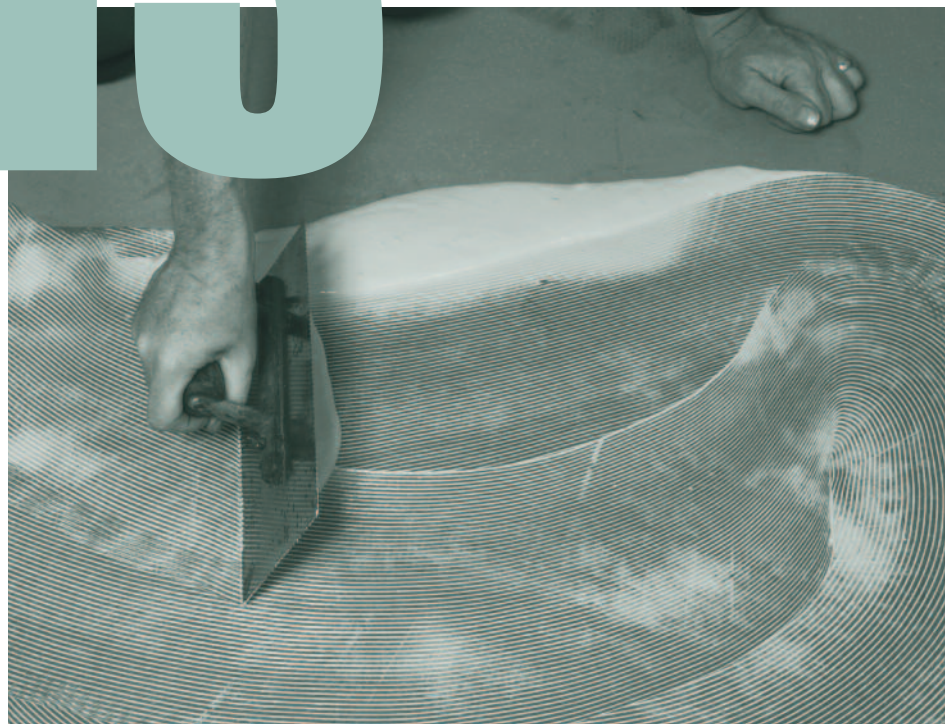

The following information is provided for guidance. The recommendations and instructions of the adhesive manufacturer must, in all cases, be followed. Only adhesives recommended by the Polyflor Technical Department and are approved as suitable, should be used. Polyflor does not make any warranties regarding the approved adhesives, or assume that other manufacturers' adhesives would not prove satisfactory. Correct handling of adhesives is recommended at all times. The Health And Safety At Work Act 1974 should be observed and, if applicable, The Highly

Flammable Liquid And Liquefied Petroleum Gases Regulations. Any hazards indicated by the adhesive manufacturer should be assessed and precautions taken as directed in the Control Of Substances Hazardous To Health legislation.

13.1 INITIAL PREPARATION

Prior to the application of the floorcovering, it should be ensured that the substrate is sound, dry and free from dust. The relative humidity of solid, cementitious subfloors should be at a maximum of 75% relative humidity when measured over at least a

72 hour period, as described in BS 8203.

Smooth, dense surfaces such as power floated concrete should be mechanically treated to provide sufficient porosity. Existing floorcoverings should be completely removed, together with the majority of the adhesive, and the resulting surface should be free from dust, grease, paint, plaster or any other contamination that may hinder adhesion. In most instances, it is beneficial to apply a smoothing underlayment, at least 3mm thick, to smooth out any local irregularities, nullify the effects of any adhesive residue and provide a surface of known porosity.

To achieve a sound bond between the floorcovering material and the substrate, it is essential that these recommendations are followed.

13.2 PRIMING THE SUBFLOOR

On porous sand/cement, concrete and all timber subfloors, it is essential that a primer be used. The use of a primer ensures an even porosity, minimises the amount of adhesive used and provides a longer open time of the adhesive. The primer used should be compatible with the subfloor and the adhesive, and be as recommended by the adhesive manufacturer.

13.3 APPLICATION OF ADHESIVE

It is strongly recommended that all adhesives are conditioned at a minimum temperature of 18°C for at least 24 hours prior to, and then during, the laying period. The adhesive must be applied using a notched trowel of the correct size notch, which must be maintained during the adhesive application stage. The adhesive manufacturer provides details of the notch size

to suit the adhesive and the application.

Acrylic pressure-sensitive adhesives should be rolled with a previously wetted, short pile adhesive roller immediately after spreading. This will remove any adhesive ridges prior to the adhesive setting, whilst maintaining the correct adhesive spread rate on the substrate.

Polyflor does not recommend any method of adhesive application, such as spraying, which cannot guarantee the spread rate.

13.4 OPEN TIME OF ADHESIVES

Open times, as recommended by the relevant manufacturer must be observed at all times.

Do not spread more adhesive than can be laid into during the open time of the adhesive.

Unlike wet set adhesives, pressure-sensitive adhesives must have all the moisture evaporated from them prior to the application of the floorcovering. The colour changes from opaque to translucent, which provides a positive indication of when the adhesive is ready to be laid into. Good ventilation and air flow will help speed up the drying time on these adhesives. It may be necessary to use an electric fan(s) to speed up the drying time.

13.5 REMOVING EXCESS ADHESIVE

As good working practice, excess adhesive should be removed as work progresses. Wet, water-based adhesives are easily removed with a clean, damp cloth. Dried water-based adhesives and solvent-based adhesives should be removed with a minimum amount of solvent cleanser, as recommended by the adhesive manufacturer. Excessive use of these cleansers can cause discolouration and softening of the vinyl surface.

13.6 ROLLING THE FLOOR

Once the floorcovering has been laid, the material should be rolled immediately with a 68kg articulated floor roller, working initially in the widthways direction, if it is sheet material. This rolling ensures good contact between the substrate, adhesive and floorcovering, expels any trapped air, and flattens the adhesive ridges to prevent shadow through once the floor becomes trafficked.

The floorcovering should be rolled again, one to four hours later, to ensure the contact between the materials is maintained.

13.7 PROTECTION FROM RADIATED HEAT SOURCES

The Polysafe range of floorcoverings is often used in situations where excessive heat causes problems with the floorcovering and the adhesive. It is impractical to give specific details, as equipment such as ovens and kilns vary in design and height above the flooring material.

Where the conditions may cause a problem, we would recommend the use of metal oven trays that deflect the heat away from the floor, and an adhesive suitable for these conditions, such as an epoxy or polyurethane. If you are unsure, we recommend that you discuss the application with our Customer Technical Services team.

13.8 APPROVED ADHESIVES

There are many different types of adhesive available in the marketplace, and the suitability for use with the range of Polyflor products depends upon a number of factors.

The formulation of the adhesive, the formulation of the floorcovering, the site

conditions and the in-use conditions all affect the selection.

The Technical Department of Polyflor checks the compatibility between the adhesive and the floorcoverings. The current list of approved adhesives for the full range of Polyflor products is available, on request, from the Customer Technical Services Department of Polyflor, their distributors or approved agents.

14 Tools and Equipment



As in all trades, a skilled floor layer should have at his disposal a basic set of tools that should be clean and in good condition.

The specific choice of tools is dependent upon the individual floor layer's preferences, the size of installation and the amount of preparation required.

The following tools should be considered as part of the basic kit for the operations indicated.

14.1 MARKING OUT & FITTING

Rule	Chalk line and chalk
Bar or long scribe	Recess scribe
Dividers or short scribes	Straight edge
Pencil and compass	Pencils
Various trimming knives	

14.2 INSTALLATION

Adhesive trowels	Triangular file
68kg articulated roller	Hand roller

14.3 HEAT WELDING

Grooving tools	Hot welding gun
Spatula trimming knife	Speedweld nozzle
Trimming guide	Oilstone

14.4 PREPARATION

Long handled broom	Hand brush
Dust pan	Hygrometer
Screeding trowel	Grind stone
Electric drill (slow speed) and rotary paddle	

14.5 MISCELLANEOUS

Claw hammer	Screwdriver
Hacksaw	Handsaw
Electric drill	Various twist drills
Mastic gun	

14.6 SAFETY EQUIPMENT

Knee pads	Safety goggles
Face mask	Circuit breaker

14.7 OPTIONAL EQUIPMENT

The following equipment is not essential but will greatly assist the floor layer, especially on larger installations.

Powered stripper	Transformer
Automatic welding machine	
Powered groover	Floor grinder
Vacuum cleaner	Extension lead

14.8 SPECIALIST TOOLS

In addition to the basic tools, there is a range of specialist tools which are designed for specific tasks such as coving, feature work, walls and repairs. Some of the more common tools are listed, together with a brief description of their usage.



Powered groover



Tape Measure



Hot air welding gun



Heat gun



Spatula trimming knife and cable cutting slide



Feed Roller

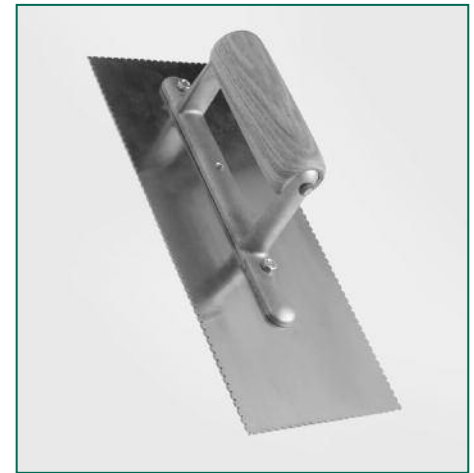

Adhesive trowel

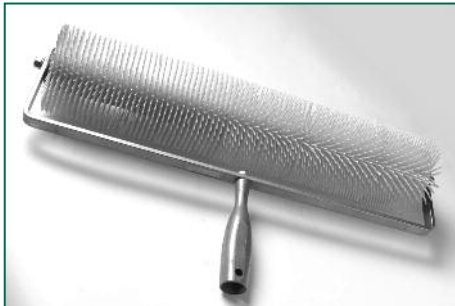

Spiked roller



Recess scribe



Hydro weld trimmer



Hand Groover



Knife



Box Scriber



Exacto tool



Straight edge



Hand roller



Cold weld tape cutter

15 Recommended finishes



There are no short cuts to optimum performance with the installation of any flooring. That is why an overview should be taken of each project so that the finishing details are considered right from the start of the project. It also means that all parties are aware of their individual areas of responsibility.

There is no question that the final details contribute so much to an impressive finish for the floor. These include relatively minor details such as awkward corners, internal or external mitres, the junction where different floorcoverings meet and finishing details around drains and other accessories.

They make up only a small proportion of the total floor, yet they often make up most of an architect's snag list.

A Polyflor installation must focus on these important details and also take into account all aspects of the location. We believe that the floor must not only look good, but also perform well, so that it is impermeable, hygienic and safe.

15.1 DRAINAGE

The location of drains is important. As far as possible, they should be away from sources of vibration (to reduce movement) and from

beams, columns and walls (to make leak detection easier). Obviously, they should be close to the main spillage sources, when direct outlets from spillage sources are not possible.

The floor gradient into the drain depends on the process, traffic volume and the surface texture of the floorcovering. The drains used should be built to permit examination, cleaning and repair without these operations causing damage to the floor.

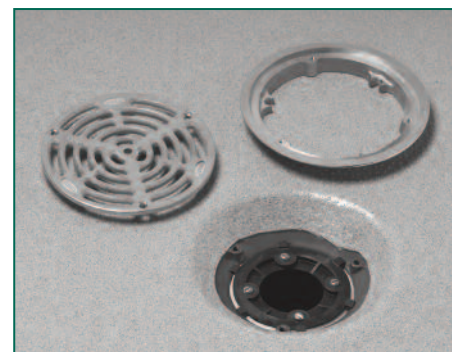

Figure 33 Stainless steel drain prior to fitting vinyl clamping ring

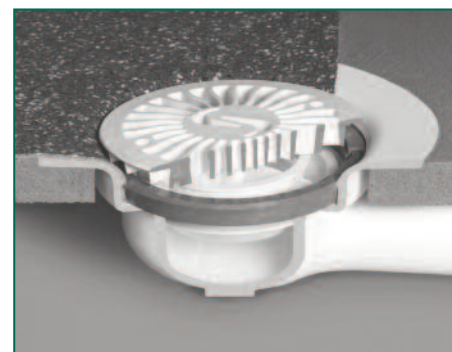

Figure 34 Drain with clamping ring in place

15.1.1 Shower Drains

Only drains which have been specifically designed for use with sheet vinyl floorings should be considered. Most of these drains have clamping rings, which ensure the

watertight security which is essential where hygiene and safety are of primary importance.

These clamping rings ensure that the Polysafe floorcovering is held securely in position and they prevent the ingress of water that could adversely affect the adhesion at this critical point.

15.1.2 Drainage channels and gulleys

Again, only drainage channels and gulleys which incorporate vinyl clamping and locking systems into their design should be considered.

15.2 CONSTRUCTION JOINT COVERS

Correct treatment at expansion joints is also essential if the floor is going to last and perform in a safe and hygienic manner. We recommend that expansion joints are covered using either a PVC expansion joint cover, or a cover with a PVC insert, so that the flooring can be thermally welded to the cover (Figure 35).

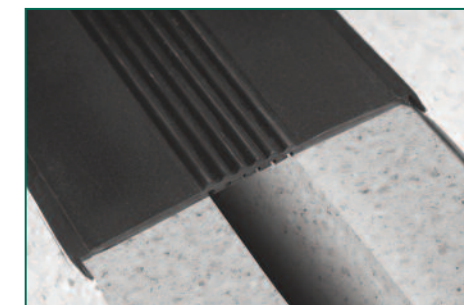

Figure 35 Expansion joint cover

On no account must the Polyflor or Polysafe be taken straight over the expansion joint. This will lead to failure.

15.3 EDGE TRIMS

In many of the areas where Polyflor is installed, other types of floorcovering will also be used. The junction between the Polyflor flooring and

these other types of floorcovering is a potential weak point, if not treated properly. Correct installation minimises problems such as water leakage and trip hazard.

15.3.1 Polyflor or Polysafe with ceramic or quarry floor tiles

In installations where the edge of the vinyl comes into contact with ceramic or quarry tiles, it is important that a watertight joint is achieved at the junction. Aluminium edge trims with PVC inserts are ideal for this purpose. They facilitate installation and the PVC insert allows for a welded joint between the edge trim and the Polyflor floorcovering.

15.4 POLYFLOR WITH CARPET

It is important that the junction between Polyflor and carpet is clearly visible and that any trip hazard is minimised by using edging strips. A variety of edging strips are available for this junction. The relevant manufacturers can supply further advice on installation and use of these types of trims.

15.4.1 Bevelled and diminishing strips

Bevelled or diminishing strips should be used at all exposed edges of Polyflor vinyl floorings to minimise trip hazards.

The bevelled strip should be butted tightly to the exposed edge of the Polyflor vinyl flooring. The bevelled strip should be fixed using a contact adhesive and the joint may be thermally welded.

15.5 ACCESS AND MANHOLE COVERS

It is important that access covers are used which facilitate either the welding of the Polyflor vinyl flooring to the cover and frame or where the Polyflor vinyl flooring can be

clamped into place. Both these solutions result in a watertight, hygienic and safe joint.

15.6 SKIRTINGS AND OTHER FINISHES

Polyflor supplies a wide range of PVC profiles which are ideal for use with the Polyflor range of products. In most installations, we would recommend that the Polyflor vinyl flooring is either site-covered up the wall, or a "set in"

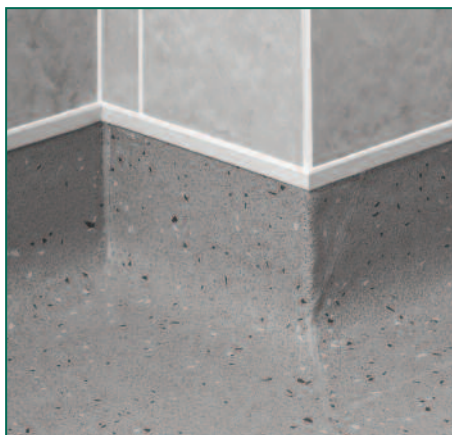

Figure 36 Polyflor Ejecta CT Strip

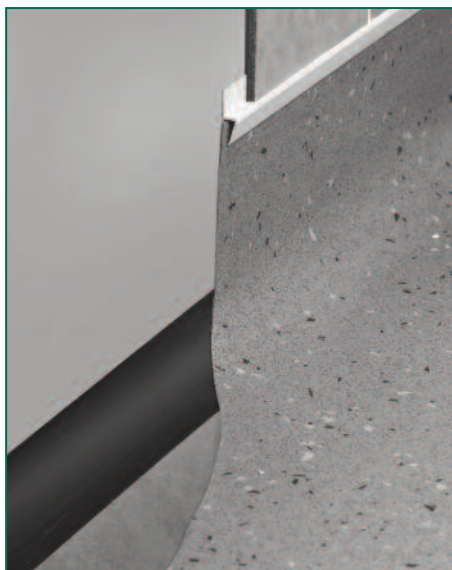

Figure 37 Polyflor Ejecta CT Strip

coved skirting is used which can be welded to the Polyflor vinyl flooring.

15.6.1 Site coving

For the junction between site-covered Polyflor vinyl flooring and ceramic wall tiles, Polyflor Ejecta CT strip (Figure 36 and 37) provides the ideal solution.

The flexible section is designed to accept ceramic wall tiles on one side and the various gauges of Polyflor on the other.

15.6.2 Set-in coved skirtings

Where it is impractical or where it is not cost effective to use the site-coved method of installation, the Polyflor Ejecta set-in skirting (Figure 38) is a viable alternative. Very similar to the sit-on type skirting in appearance, the set in skirting has a 50mm toe which is adhered to the subfloor and allows the main field of sheet vinyl to be welded to it.

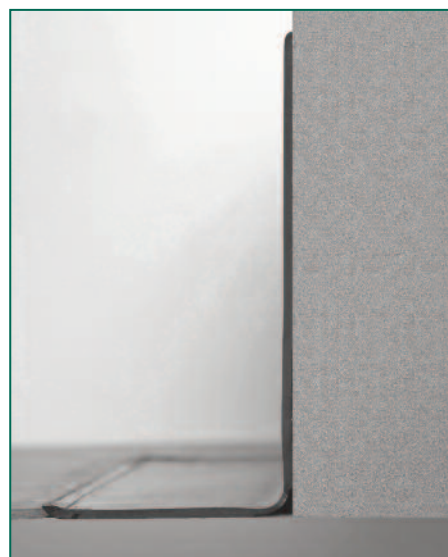

Figure 38 Set-in coved skirting

15.7 SIT-ON SKIRTINGS

Sit-on skirting (Figure 39) generally tend only to be used in conjunction with tiled floors to provide a finish around the perimeter of the room. The sit-on skirting is adhered to the walls and the toe of the skirting sits on top of the floor; it is not welded. If requested suitable mastic sealant can be used beneath the toe of the skirting.



Figure 39 Sit-on coved skirting

15.8 MASTIC SEALANT FINISH

When specified suitable silicon mastics can be used as a finish around the perimeter of a room. This is provided a water tight finish is not required and all parties are in agreement as to this type of finish.

16 Resistance to chemicals



16.1 POLYFLOR VINYL FLOORING

Polyflor and Polysafe vinyl floorcoverings show an above average resistance to mild and dilute acids, alkalis, soaps and detergents. Petrol and strong acids are not harmful, provided any spillage is cleaned off immediately.

Ketones, chlorinated solvents, acetone and similar solvents should not be allowed to come into contact with Polyflor vinyl flooring. However, if this should happen, the effect can be minimised by removing the spillage immediately and leaving any solvent residue to evaporate, prior to allowing any foot traffic.

Polyflor vinyl floorcoverings are suitable for

use in all areas where most chemicals are used and there is only risk of accidental spillage.

However, some chemicals contain very strong dyes, which, even after a short period of contact, will stain the vinyl flooring. In areas where these types of chemicals are used, it is suggested that an appropriate dark colour be selected to minimise the staining effect.

The following tables summarise the general chemical resistance of Polyflor vinyl flooring (see footnote for brief description of test procedure). Where specific chemicals are used - for instance in a photographic laboratory - a set of chemical resistance charts is available on

request. These charts show the resistance to a range of specific chemicals by shade for each Polyflor product, and will prove helpful in selecting colours which are least affected by specific chemicals.

Note: Polyflor test for resistance to chemicals is evaluated over a 24 hour contact period at a room temperature of 21°C, followed by rinsing with cold water. Polyflor believes this simulates the worst situation where spillages are not removed immediately and are only cleaned by normal maintenance. Some stains can be removed by abrading with a nylon pad during maintenance. A metallised emulsion floor polish can be used as a sacrificial layer for protecting the floor against staining.

16.2 POLYFLOR RUBBER FLOORCOVERINGS

Polyflor Rubber floorcoverings have average resistance to mild and dilute acids, alkalis, soaps and detergents. Prolonged exposure to petrol, oils, greases and fats will cause softening and swelling. Polyflor Rubber floorcoverings are unsuitable for garage workshops or food preparation areas, but are suitable for areas

where spillage is infrequent. Occasional, accidental spillages, which are removed immediately, do not normally damage the flooring. A comprehensive guide to chemical effects and staining by product shade is available on request.

16.3 REACTION TO RUBBER

Antioxidants used in the manufacture of rubber can cause staining. Non-rubber traffic mats are recommended, as are tyre trays for car showrooms, etc. Using black or dark brown floorcoverings will not prevent staining but will disguise it. Lighter coloured rubber can also be specified for appliance feet, trolley wheels etc.

16.4 ALCO-BASED HAND GELS

Polyflor homogeneous PUR, heterogeneous PUR and Polysafe safety flooring ranges are compatible for use with the most commonly used alco-based hand gels.

Some alco-based hand gels contain a high concentration of ethanol and to discuss their compatibility with other Polyflor floorcoverings, contact Customer Technical Services.

ORGANIC LIQUIDS	EFFECT	ACTION
Aldehydes Esters Halogenated hydrocarbons Ketones	Flooring attack occurs after several minutes.	Wipe up immediately.
Alcohols Ethers Glycols Hydrocarbons (aromatic & aliphatic) Petroleum spirit Vegetable oil	After several days, plasticiser extraction occurs, with associated problems of shrinkage and embrittlement.	Wipe up immediately.

AQUEOUS SOLUTIONS	EFFECT	ACTION
Mild acids and alkalis	No effect.	
Strong alkalis	Will strip polish and may cause discolouration in some shades.	Dilute and remove.
Strong acids	Prolonged contact can cause discolouration.	Dilute and remove immediately.
Dyes (indicators)	Contact can cause discolouration.	Dilute and remove immediately.

Use area classifications



Selecting a floorcovering that will satisfy the actual or expected service requirements is essential if a product is to perform up to the end user's expectations. With so much product information now available, it is hardly surprising that selection can sometimes be difficult.

Polyflor vinyl floorcoverings, for example, are manufactured in a range of thicknesses, with differing levels of filler and constructions, to suit a variety of applications. In addition, some vinyl floorings have specialist features such as acoustical, static control or slip-resisting properties. These are the variables from just one manufacturer!

So in order to help the end user and/or the building designer make an informed choice, the majority of Polyflor products now show the European use area classifications and the Agrément ratings. The Use Area Classifications can only be claimed if the products meet the requirements of the performance criteria that have been laid down. The Agrément rating is awarded by one of the national Agrément assessment bodies and only after an independent assessment of the product, both in laboratory conditions and on-site use.

A basic understanding of both systems is useful when making decisions on suitability of

CLASS	SYMBOL	LEVEL OF USE	DESCRIPTION
		domestic	areas considered for residential use
21		Moderate	Areas with low or intermittent use
22		General	Areas with medium use
23		Heavy	Areas with intense use
		commercial	areas considered for public and commercial use
31		Moderate	Areas with low or intermittent use
32		General	Areas with medium traffic
33		Heavy	Areas with heavy traffic
34		Very Heavy	Areas with intense use
		industrial	areas considered for light industrial use
41		Moderate	Areas where work is mainly sedentary with occasional use of light vehicles
42		General	Areas where work is mainly standing and/or with vehicular traffic
43		Heavy	Other light industrial areas

Use area classification table

products. A general guide to both systems follows:

17.1 EUROPEAN CLASSIFICATION EN 685

This European Norm describes the various levels of use area, the relevant icons and typical applications. These typical applications may vary from country to country as room usage

varies and some applications may require a higher rated product.

The European system has three specific use categories, with sub-divisions based on type and intensity of traffic (see the above chart.) Individual EN product specifications detail the performance and physical criteria that a

product must meet to achieve the classification – and products can meet the criteria of all three groups. When a higher classification number is claimed, the product will meet all the requirements of the lower classes in that group.

The individual EN product specifications allow for products of different filler levels and abrasion resistance and define minimum overall and wear layer thickness for each classification. Homogeneous products, being 100% wear layer, are classified using the minimum wear layer thickness and the overall thickness. Compared to an heterogeneous product of the same classification which would give a typical life expectancy of 10 years, a 'P' abrasion group homogenous product has twice as much useful life and as such the life expectancy would be 20 years in a class 34/43 use area.

17.2 AGRÉMENT SYSTEM

The Agrément system, which originated in France, has been in use for many years. The ratings were based on four key physical properties. The results which the product achieved against a test criteria in each category gave it the overall rating. (The higher the number, the better the performance.)

The overall performance was then quoted as a UPEC rating and this system is still recognised today in France. In 1987, the scheme for floorcoverings was revised, but still retained the basic concepts that made the scheme so

useful. The revision, carried out in conjunction with the European floorcovering manufacturers, made the overall scheme simpler. As all vinyl floorcoverings achieved a C2 rating when tested, it was felt unnecessary to include this and the new system concentrated on the U, P and E ratings.

The new scheme was termed the GWS system, with G being the general classification ranging from 1 to 5 and being a combination of the previous U and P ratings. W indicates that the product can tolerate wet cleaning but not standing water. WS indicates the product can tolerate standing water by having the joints welded. The W and S replace the previous E rating.

A comparison of both ratings is as follows:

G1 is equivalent to U₂ P₂

G2 is equivalent to U₂+P₂

G3 is equivalent to U₃ P₂

G4 is equivalent to U₃ P₃

G5 is equivalent to U₄ P₃

No W rating is equivalent to E₁

W rating is equivalent to E₂

WS rating is equivalent to E₃

The Agrément bodies produce a comprehensive listing of typical use areas, which are too numerous to list here, together with the product rating required. Contact Polyflor or

their overseas agents for the address of the local national body that can provide this information.

17.3 EUROPEAN NORMS

European Norms - or "EN"s - are aimed at harmonising industry standards throughout the European Union and EFTA countries, and have now replaced the old British Standards relating to floorcoverings.

The standards are:

EN 649 covering homogeneous and heterogeneous vinyls, and replacing BS 3261A.

EN 650 covering jute or polyester backed vinyls.

EN 651 covering homogeneous and heterogeneous vinyls on PVC foam, and replacing BS 5085.

EN 652 covering vinyl flooring with a cork based backing.

EN 653 covering expanded PVC flooring such as cushion vinyls.

EN 654 covering semi-flexible PVC tiles, and replacing BS 3260.

EN 655 for PVC tiles with a base of agglomerated cork and a PVC wear layer.

The relevant ENs which apply to Polyflor vinyl floorcoverings are 649, 651 and 654.

Under EN 649, products are given an abrasion group rating. There are two test methods accepted for abrasion which have an established correlation; EN 660 Parts 1 and 2. Either can be used to establish the abrasion category.

The ratings are expressed as T,P, M and F. These groups were chosen with reference to the already well established Agrément system, and relate to the idea of a notional 10-year life expectancy in a given use area. The initials come from the French: Transparent, Pas ou Peu chargé, Moyen chargé and Fortement chargé, and basically relate to the amount of filler (chargé) used in a formulation.

EN 649 defines the performance criteria which products must meet in order to claim Use Area Classification under EN 685, as discussed in Section 17.1.

In addition to the vinyl specification, specifications for rubber flooring have now been published. They are:

EN 1817 Homogeneous and heterogeneous rubber flooring.

EN 1816 Homogeneous and heterogeneous rubber flooring with foam backing.

EN 12199 Homogeneous and heterogeneous relief rubber flooring.

PROPERTY	(FRENCH TERM)	SYMBOL	RANGE
Wear	(Unsure)	U	1-4
Penetration	(Poinçonnements)	P	1-4
Water resistance	(Eau)	E	1-3
Chemical resistance	(Chimique)	C	1-3

18

Operating service temperature



The full range of Polyflor and Polysafe sheet vinyl floorcoverings can be used under a wide range of service temperatures.

Maximum upper temperature 60°C (140°F)

Minimum lower temperature -20°C (-4°F)

Use in such extreme conditions is dependent upon the correct selection of adhesive. Guidance should be sought from the adhesive manufacturer for approval of the adhesive at the expected temperatures. Typically, an approved two-part epoxy or polyurethane adhesive should be used in the main field, and a contact adhesive for vertical applications.

It is important that the materials be conditioned and installed at normal room temperatures: 18°C (65°F). The material should be fully adhered to the substrate, taking care to ensure that there are no unsupported voids beneath the vinyl. In these types of installation, and where site coving is specified, then a pencil cove should be used, and not one with a cove former. All joints should be hot welded 24 hours after installation and before the installation is taken to the service temperature.

Both Polyflor and Polysafe ranges can withstand occasional sudden changes in

temperature caused by short-term contact with hot water and steam. **Long-term or regular contact should be avoided.** Where there is a possibility of regular contact with liquid gases, which are extremely cold, the constant expansion and contraction of the vinyl may cause premature failure. In these instances, it can be beneficial to have a second piece of vinyl loose laid on top of the floor, to protect it. Should this become damaged, it can be easily and economically replaced.

18.1 UNDERFLOOR HEATING

All the Polyflor and Polysafe vinyl product ranges can be installed over underfloor heating. In installations where underfloor heating is used, this should be switched off from 48 hours prior to installation until 48 hours afterwards. It should then be slowly brought back up to the working temperature, a maximum of 27°C. Adhesives capable of withstanding temperatures up to 27°C should be used.

Please note: It is recommended that underfloor heating systems are commissioned prior to the flooring being installed to ensure the heating system is operating correctly. The above installation procedure should then be followed.

18.2 AREAS SUBJECTED TO PROLONGED SUNLIGHT

Large, sun-facing windows (especially where under-floor heating is in use) and conservatories can experience problems due to high daytime temperatures and low night-time temperatures. In these instances, it is necessary to ensure that an even day and night temperature is maintained during the laying

period and until the adhesive reaches its full bond strength, which is normally three days. To ensure the best results, shade all windows, turn off any underfloor heating, provide background heating at 18°C and select an epoxy or polyurethane grade adhesive. Condition the tiles correctly prior to installation. Polyflor will not accept responsibility for any expansion or shrinkage problems, which may result from changes in temperature during the period when the adhesive is reaching full bond strength. All Polyflor floor coverings are designed for internal usage only. We cannot guarantee the performance of any of our floor coverings in external environments.

Maintenance



19.1 INTRODUCTION TO MAINTENANCE

19.1.1 Why is floorcare necessary?

Floorcoverings are selected for many reasons including their colour, design and sometimes specialist properties such as static control or slip resistance. Without regular maintenance, dust and soiling would soon build up, making the colour and design indistinguishable and the specialist properties practically useless. Dirt and soiling can also harbour bacteria, making the floorcovering a health hazard e.g. in hospitals or food processing areas. Dust and grit underfoot can also act as an abrasive,

which, if left uncontrolled, would shorten the life of a floorcovering, causing premature replacement. Regular and well planned maintenance keeps the floorcovering in pristine condition and can enhance the original appearance. Maintenance can also reduce wear and ultimately improve the life expectancy of the floorcovering.

19.1.2 What is maintenance?

Maintenance means many things to many people. To some, it is an army of operatives using modern powered machines working to a comprehensive maintenance programme.

To others, it is someone who comes in three evenings a week to dust and mop the floors. In each case, the requirement for cleanliness and gloss can be completely different.

It is this variability in what is considered normal that makes it impracticable in this manual to give precise maintenance instructions to suit specific end user locations. The instructions given are intended to be used as a guide. They are based on general experience using established methods and cleaning materials. Polyflor recommends that the instructions are followed initially and, as traffic patterns become established, the frequency is tailored to suit.

19.1.3 Tailored Maintenance

Reducing maintenance costs is not difficult; what takes much more skill is reducing these costs without cutting the effectiveness of the maintenance system. By tailoring a maintenance programme, real savings can be made without compromising standards of appearance, hygiene and cleanliness.

A tailored maintenance programme is simple to apply, with the effort (and thus the cost), concentrated where each location demands. This produces definite savings and considerable return on a floorcovering investment.

Certain Polyflor ranges benefit from enhanced formulations in relation to maintenance. The PUR or Supratec PUR families provide long term maintenance benefits. The PU family facilitates a reduction in the intensity of the construction clean and provides the foundation for the ongoing maintenance regime.

In our experience, a tailored maintenance

approach is the best solution for all types of floorcoverings.

19.1.4 The Polyflor in-depth approach

We begin by looking at the many variables which have a part to play in maintenance. These include floor location, type and quantity of traffic, and the existence or otherwise of dirt barriers. Armed with this information, a solution which gives real savings without affecting the floor's appearance, hygiene or cleanliness can be developed.

19.2 POINTS TO CONSIDER

Before establishing a maintenance programme, there are some points which should be considered, as they can affect the method and frequency - and hence the cost - of maintenance.

19.2.1 Dirt Barrier Systems

Evidence from a wide range of studies indicates that up to 80% of all dirt, grit and moisture is carried into a building by the people using it. One of the easiest ways to reduce maintenance costs must therefore be to reduce the amount of dirt, grit and moisture they bring in. Not only would this cut the cost of its removal, but it would also cause less abrasive action on the floorcovering, which in turn would ensure a longer useful life. With less moisture, there would also be less potential for slipping.

Unfortunately, notices asking people to thoroughly wipe their feet rarely work. What is needed is an effective "passive" dirt barrier system. At first, these systems can seem expensive but the savings they provide over the long term are substantial.

An effective dirt barrier system has both scraping and absorbing qualities and is

sufficiently large to perform these actions on both feet during normal walking - hence "passive". Dirt barrier systems should be considered early in the specification stage. They should not be an afterthought, when there are rarely sufficient funds or space to do the job properly.

19.2.2 The Ideal Dirt Barrier



Figure 40 An exterior scraper mat at least two paces wide, set into a matwell. The choice of materials is varied. Clearance should be sufficient to allow grit and debris to fall below. Also allowances must be made for the wearers of various types of shoes e.g. stiletto heels.



Figure 41 An interior grade combination scraper/moisture mat of two to three metres in length. This will remove the majority of moisture and any fine abrasive particles. This can also be set into a matwell. Again, the choice of materials is wide and often the barrier will be a composite of several materials.

Note: To maintain the effectiveness of dirt barrier systems, they must be cleaned regularly, otherwise they can actually increase the soil intake by creating a "soil reservoir" at the entrance to the building.

19.3 ASSESSING THE LOCATION

As mentioned earlier, by tailoring the maintenance programme, real and achievable savings can be made without compromising

standards of appearance, hygiene and cleanliness. The first part of this process is to break down areas to be cleaned into a series of independent locations. Each location should then be assessed before a particular maintenance regime is employed.

This should provide a clear indication as to where the effort and therefore the cost should best be applied.

These assessments should be reviewed periodically, to ensure that standards are to the level expected by the client and that cost savings are being achieved wherever this is possible.

19.3.1 Points to consider

The assessment should consider the following points:

LOCATION

Position of the location in the building. Entrance areas and receptions will require more intensive, frequent cleaning than upper floor, low circulation corridors.

SOILING

Type of soiling which is likely to be found in the location. Dirt and grit from an outside car park will require a different treatment from chemical spillage in a laboratory.

CLIENT EXPECTATIONS

The expectation of the client for that particular location plays an important part. Obviously, if a high shine is required, the maintenance regime must be able to provide this.

TRAFFIC

Traffic types, density and frequency in the given location. The type of footwear used by children in school corridors provides a different situation

from that where soft soled trainers or pumps are used in the school sports hall.

TYPE OF CLEANING EQUIPMENT

Manual methods can be time consuming in large areas and may be incompatible with the frequency requirement. However, large machines used in confined spaces can take longer than manual methods.

COLOUR OF FLOORCOVERING

In general, light colours show soiling more easily, dark colours show loss of gloss more easily. Mid range colours will give a balance between the two extremes.

PREVAILING WEATHER

In icy conditions, grit and salt are sometimes used outside building entrances. In dry conditions, dust and sand can also be found outside buildings. In both instances, soiling and abrasion can be accelerated if effective measures are not taken to prevent them being trafficked into the building.

19.3.2 The Assessment should establish the following:

1. *The type of cleaning needed*
2. *The frequency of cleaning*
3. *The cleaning products and equipment needed*
4. *The level of labour required*
5. *The time to be allocated*

19.4 INDIVIDUAL PRODUCT MAINTENANCE PROCEDURES

As the Polyflor product portfolio has developed, the maintenance procedures have become specific to generic types which are:

Smooth products with PUR (polyurethane reinforcement)

Smooth products with PU (polyurethane surface treatment)

Smooth products without PUR or PU

Polysafe products with Supratec PUR enhanced formulation

Polysafe products without Supratec PUR

ESD ranges where no polish should be applied

Rubber floorcoverings

The general maintenance procedures are listed in the subsequent pages. We also provide hard copies (on request) or electronic copies (through the web site) of individual floorcare procedures, to guide the end user or maintenance staff.

19.5 STANDARD SMOOTH VINYL WITH PUR

The Polyflor PUR family of products incorporates a polyurethane reinforcement, which protects the floorcovering by resisting soiling and scuffing. Combined with the superior closed surface finish, this enhanced protection allows the use of a polish-free maintenance regime. This protection ensures that the intensity of the maintenance and overall cleaning costs are significantly reduced.

The following maintenance instructions are designed to maximise the benefits of the PUR, resulting in lower maintenance costs, without compromising the long-term appearance of your floorcovering.

19.5.1 Initial construction clean

- A. *Remove all loose debris.*
- B. *Ensure that all traces of adhesive are removed from the surface of the floorcovering.*
- C. *Mop sweep or vacuum to remove dust and grit.*
- D. *Damp mop with a neutral detergent.*
- E. *If required, dry buff with a 1000 rpm plus rotary machine fitted with a suitable clean pad.*

19.5.2 Routine maintenance

The following recommendations are provided as a guideline, and the frequency can be changed to optimise the appearance.

DAILY

Mop sweep or vacuum to remove dust and loose dirt. If required, spot mop to remove stubborn marks, with a neutral cleanser.

WEEKLY

Assess the appearance of the floor.

Undertake the following as required:

Light scuffing – dry buff with a 1000 rpm plus rotary machine fitted with a suitable clean pad. or

Heavier scuffing – spray clean using a floor maintainer and 1000 rpm plus rotary machine fitted with a suitable clean pad.

19.5.3 Periodic Maintenance

A. Assess the appearance of the floor. If the floor has dirt build-up, machine scrub with a scrubber dryer (approx. 165 rpm) fitted with a suitable clean pad, using a neutral or alkaline detergent, as appropriate.

B. Rinse thoroughly and allow to dry.

C. Dry buff to restore finish.

19.5.4 Additional Information:

1. The maintenance regime requires the installation of an effective barrier matting system.

2. Cleaners and detergents should be diluted as per the manufacturers' instructions.

3. Always follow the Health and Safety guidance provided.

4. Fit protective feet to table and chair legs, to prevent scratching.

5. These maintenance instructions are intended for the PUR family of floorcoverings, which have a polyurethane reinforcement.

For other Polyflor products, reference should be made to the relevant section or to their specific floorcare sheets.

6. In most instances, the above maintenance regime will be sufficient to ensure your floorcovering retains the optimum appearance. However where there is no mechanical means of maintaining the floor, an emulsion floor polish should be applied. Details of the procedure to be used can be found under the Standard Vinyl with PU section.

7. Regular cleaning is more beneficial to the floorcovering and more cost-effective than occasional heavy cleaning.

19.6 STANDARD SMOOTH VINYL WITH PU

Polyflor smooth vinyl 'PU' floorcoverings incorporate a polyurethane surface treatment, which protects the floorcovering by resisting soiling and scuffing. This protection facilitates a reduction in the intensity of the construction clean and provides the foundation for the ongoing maintenance regime. This easier cleanability offers maintenance cost savings when compared with non-treated materials.

The following maintenance instructions are designed to minimise the cost factor, without compromising the long-term appearance of your floorcovering.

19.6.1 Initial construction clean

A. Remove all loose debris.

B. Ensure that all traces of adhesive are removed from the surface of the floorcovering.

C. Mop sweep or vacuum to remove dust and grit.

D. Damp mop with a neutral detergent.

E. If required, dry buff with a 1000 rpm plus rotary machine fitted with a suitable clean pad.

19.6.2 Routine maintenance

The following recommendations are provided as a guideline, and the frequencies can be changed to optimise the appearance.

DAILY

Mop sweep or vacuum to remove dust and loose dirt. If required, spot clean to remove stubborn marks with a neutral cleanser. If required, dry buff to restore finish.

WEEKLY/MONTHLY

Assess the appearance of the floor. If required, scrub with a scrubber dryer fitted with suitable pads, and using neutral cleanser (pH 7 to 9). If required, dry buff to restore finish.

19.6.3 Application of a floor dressing

The Polyurethane surface treatment will provide initial protection for the floorcovering. However, an application of a metallised polish may be required eventually to provide extra protection. The level and intensity of traffic and soiling will determine how soon the polish will have to be applied. For polish free maintenance, see the Polyflor PUR range of products. For polish application, please follow details of the procedure below.

A. Using an applicator and tray, or Kentucky mop with wringer and bucket, the first coat should be applied thinly and evenly across the floor, to within 200mm of the skirtings. It should then be left to dry. This normally takes approximately thirty minutes, depending on the ambient conditions and the thickness of the coating.

B. When the first coat is dry, a second coat

should be applied at right angles to the direction of the first. Subsequent coats should be applied at right angles, and the final coat should be applied right up to the skirting.

Two to three thin coats are usually sufficient to provide excellent resistance to abrasion, scuffing and removal of black heel marking. However, be guided by your own periodic assessments for the particular location.

In order to minimise costs, subsequent polish applications may be applied only to traffic paths.

Periodically - generally every six months - assess the appearance of the floor. If there is an unacceptable build-up of polish, this should be stripped and reapplied, as per the instructions above.

19.6.4 Additional Information:

1. The maintenance regime requires the installation of an effective barrier matting system.

2. Cleaners and detergents should be diluted as per the manufacturers' instructions.

3. These maintenance instructions are intended for the Polyflor 'PU' family, which incorporates a polyurethane surface treatment. For other Polyflor products, reference should be made to the relevant section or to their specific floorcare sheets.

4. For further guidance, contact Polyflor Customer Technical Services.

5. Always follow the Health and Safety guidance provided.

6. Regular cleaning is more beneficial to the floorcovering and more cost-effective than occasional heavy cleaning.

19.7 STANDARD SMOOTH VINYL RANGES WITHOUT PU OR PUR

19.7.1 Initial construction clean

A. Sweep, mop sweep or dry vacuum the floor, to remove dust, grit and debris.

B. For light soiling, damp mop the floor with a neutral cleanser diluted to the manufacturer's instructions.

or

For heavy soiling, apply a solution of alkaline cleanser, diluted to the manufacturer's instructions, to the floor and leave for sufficient time to react with the soiling. Using a 165 to 350 rpm rotary machine fitted with a scrubbing pad, machine scrub the floor and then pick up the slurry with a wet vacuum. Rinse the floor thoroughly with clean warm water, pick up with a wet vacuum and leave to dry thoroughly.

19.7.2 Application of a floor dressing

A. Ensure that there is a good key between the floor dressing and the surface of the flooring, scrubbing the floor if required.

B. Either of the following methods can be used:

EMULSION POLISH.

Apply two or three thin coats of emulsion polish in accordance with the manufacturer's instructions, with either a proprietary polish applicator or Kentucky mop wrung out to prevent over-application of polish. The polish should be applied up to 150mm from the edges of the room, and subsequent coats should be applied at 90° to the previous one. The final coat should be applied right up to the edges of the room.

or

SPRAY CLEAN/POLISH.

The floor maintainer should be used undiluted for

the first 2–3 applications, to enable a protective film to be developed as quickly as possible and, thereafter, in accordance with the manufacturer's instructions.

Note: To provide adequate protection in high traffic areas, it can be more effective to apply an emulsion polish, rather than spray clean/polish. Where a high shine finish is undesirable, a matt finish polish should be used.

19.7.3 Routine maintenance

The frequency of each of the operations is dependent upon the type and intensity of traffic.

A. Sweep, mop sweep or dry vacuum the floor, to remove dust and loose dirt.

B. Spot mop frequently. Stubborn black marks can be removed by using the centre disc of a scrubbing pad and a small amount of undiluted alkaline cleanser. Place the disc under the sole of the shoe and rub – this gives greater pressure. Rinse the area well with clean warm water and leave to dry.

C. Depending upon the end user requirement and the equipment available, one of the following methods should be used: Using floor maintainer, diluted to the manufacturer's instructions, mop the floor and leave to dry. If a shine is required, the floor should be buffed with a 500 to 2000 rpm rotary machine fitted with a suitable pad.

or

Using floor maintainer, diluted to the manufacturer's instructions, spray a fine mist onto the floor. Using a 165 to 500 rpm rotary machine and suitable spray cleaning pad, buff the floor to the desired shine. The dirt is picked up in the pad, which should be thoroughly

cleaned after use. Failure to do so will result in a shiny, dirty floor.

or

Using a neutral or germicidal cleanser, diluted to the manufacturer's instructions, mop the floor and allow to dry completely. Using a 500 to 2000 rpm rotary machine, buff the floor to the desired level of shine.

Note: When high speed burnishing, it is important that the machine is kept constantly moving. This avoids excessive heat build-up on the floor. As an additional precaution, we advise that a spray of clean water is used, to help lubricate the pad.

19.7.4 Removal of a floor dressing

An unsightly build-up of polish should be avoided. The polish should be removed regularly - the interval between application and removal depends on the wear conditions and the number of polish layers (normally six months in heavy traffic areas.) Follow the manufacturer's instructions.

19.7.5 Additional Information

1. Always follow the Health and Safety guidance provided.

2. Regular cleaning is more beneficial to the floorcovering and more cost-effective than occasional heavy cleaning.

19.8 POLYSAFE RANGES WITH PUR

The following maintenance instructions are designed to minimise the cost factor, while ensuring that your floorcovering retains the optimum appearance and performance. The exclusive Polysafe PUR system reduces the intensity of cleaning and the use of chemicals, which helps minimise the effect on

the environment, without compromising such key elements as hygiene and underfoot safety.

19.8.1 Construction clean

Polysafe PUR is designed to resist soiling, which ensures that - even after transportation, installation and the period prior to handover - the intensity of construction clean can be significantly reduced. This will have a beneficial impact on the initial costs.

A. Remove all loose debris.

B. Remove surface dust and grit by sweeping or vacuuming.

C. Apply a solution of neutral cleanser (or alkaline cleanser, dependent upon the level of soiling), diluted to the manufacturer's instructions, with a spray over the section to be cleaned. Leave for sufficient time to react with the soiling.

D. Pick up the solution with a clean microfibre mop, using a continuous side-to-side motion. When the mop head becomes loaded, it will start streaking the floor. At this point, the dirty mop head should be removed and placed into a laundry bag and a clean mop head fitted. The cycle should then be repeated until the whole floor is completed.

E. The dirty mop heads should then be laundered in preparation for reuse.

Note: If the floor has been heavily scuffed, it may be necessary to use a Doodle bug or similar tool fitted with a suitable pad to remove the scuff marks

19.8.2 Daily maintenance

A. Remove surface dust and grit by sweeping or vacuuming.

B. Apply a solution of neutral cleanser (or alkaline cleanser, dependent upon the level of grease or

oily contaminates), diluted to the manufacturer's instructions, with a spray over the section to be cleaned. Leave for sufficient time to react with the soiling.

C. Pick up the solution with a clean microfibre mop, using a continuous side-to-side motion. When the mop head becomes loaded, it will start streaking the floor. At this point, the dirty mop head should be removed and placed into a laundry bag and a clean mop head fitted. The cycle should then be repeated until the whole floor is completed.

D. The dirty mop heads should then be laundered, in preparation for reuse.

E. Where detergent residue remains on the floor surface, the area should be rinsed completely with clean, warm water, picked up with a wet vacuum and left to dry thoroughly.

F. In areas subject to heavy soiling, machine scrubbing should be undertaken on a periodic basis, after neutral or alkaline cleanser has been applied to the floor, diluted to the manufacturers' instructions.

19.8.3 Additional Information

1. This maintenance procedure has been designed to optimise the benefits of the Polysafe PUR system – the latest in proven cleaning technology. The maximum benefits are derived from this system by carrying out this quick and simple procedure on a daily basis, and by using clean equipment each time, to maximise dirt pick-up and eliminate streaking.

2. A floor dressing or maintainer containing polish should not be applied to Polysafe ranges with PUR, as this may impair the slip resistance. If in doubt, consult our Customer Technical Services staff.

3. Always follow the Health and Safety guidance provided.

4. Regular cleaning is more beneficial to the floorcovering and more cost-effective than occasional heavy cleaning.

5. Cleaners and detergents should be diluted as per the manufacturers' instructions. For recommended products, see the Polyflor Approved Maintenance Products sheet located within the Technical section of www.polyflor.com

6. Polysafe safety flooring ranges are compatible for use with the most commonly used alco-based hand gels and are suitable for steam cleaning on a periodic basis.

All the above methods of maintenance can be applied to Polysafe PUR and Polysafe Supratec PUR products - the 3rd generation maintenance enhancement available on flagship Polysafe ranges.

19.9 POLYSAFE RANGES WITHOUT PUR

19.9.1 Construction clean

A. Sweep, mop sweep or dry vacuum the floor to remove dust, grit and debris.

B. Apply a solution of alkaline cleanser, diluted to the manufacturer's instructions, to the floor and leave for sufficient time to react with the soiling.

C. Using a 165 rpm rotary machine fitted with a rotary scrubbing brush or, if necessary, a scrubbing pad, machine scrub the floor and then pick up the slurry with a wet vacuum.

D. Rinse the floor thoroughly with clean warm water, pick up with a wet vacuum and leave to dry thoroughly.

For small areas, where there is no suitable scrubbing machine available, a deck scrubber should be used in conjunction with a wet

vacuum or mop and bucket system.

Dilution rates above the manufacturer's minimum recommendations may be necessary for very heavy soiling.

For Polysafe Hydro, the scrubbing pad should be replaced with a rotary scrubbing brush or a cylindrical type scrubbing machine.

19.9.2 Ongoing maintenance

For ongoing maintenance, the frequency of each of the operations is dependent upon the type and intensity of traffic as well as the appearance expectations and should be adjusted to suit.

19.9.3 Standard surface finish

A. Sweep, mop sweep or dry vacuum the floor, to remove dust and loose dirt.

B. Spot mop regularly. Stubborn black marks can be removed by using the centre disc of a scrubbing pad and a small amount of undiluted alkaline cleanser. Place the disc under the sole of the shoe and rub – this gives greater pressure. Rinse the area well with clean warm water and leave to dry.

C. Apply a solution of neutral or alkaline cleanser, diluted to the manufacturer's instructions, to the floor and leave for sufficient time to react with the soiling. Using a 165 rpm rotary machine fitted with a rotary scrubbing brush or, if necessary, a scrubbing pad, machine scrub the floor and then pick up the slurry with a wet vacuum. Rinse thoroughly with clean, warm water, pick up with a wet vacuum and leave to dry thoroughly.

19.9.4 Polysafe Hydro with embossed surface finish

A. Sweep, mop sweep or dry vacuum to remove dust and loose dirt.

B. Spot scrub regularly with a deck scrubber.

C. Apply a solution of neutral or alkaline cleanser, diluted to the manufacturer's instructions, to the floor and leave for sufficient time to react with the soiling. Using a 165 rpm rotary machine fitted with a bristle brush, cylindrical machine or deck scrubber, scrub the floor and pick up the slurry with a wet vacuum. Rinse thoroughly with clean, warm water, pick up with a wet vacuum and allow to dry thoroughly.

19.9.5 Additional Information

1. A floor dressing should not be applied to Polysafe floorcoverings, as this may impair the slip resistance. If in doubt, consult our Customer Technical Services staff.

2. Always follow the Health and Safety guidance provided.

3. Regular cleaning is more beneficial to the floorcovering and more cost-effective than occasional heavy cleaning.

4. Cleaners and detergents should be diluted as per the manufacturers' instructions. For recommended products, see the Polyflor Approved Maintenance Products sheet located within the Technical section of www.polyflor.com

5. Polysafe safety flooring ranges are compatible for use with the most commonly used alco-based hand gels and are suitable for steam cleaning on a periodic basis.

19.10 THE ESD FAMILY

The ESD family of vinyl floorcoverings are designed to prevent damage to processes, equipment or people by conducting static charges away at a rate that prevents damage.

In order to ensure the ESD features work effectively, it is important that the instructions below are followed. Failure to do so could render the ESD system ineffective.

19.10.1 Construction clean

A. Sweep, mop sweep or dry vacuum the floor, to remove dust, grit and debris.

B. For light soiling, damp mop the floor with a neutral cleanser, diluted to the manufacturer's instructions.

or

For heavy soiling, apply a solution of alkaline cleanser, diluted to the manufacturer's instructions, to the floor and leave for sufficient time to react with the soiling. Using a 165 to 350 rpm rotary machine fitted with a scrubbing pad, machine scrub the floor and then pick up the slurry with a wet vacuum. Rinse the floor thoroughly with clean warm water, pick up with a wet vacuum and leave to dry thoroughly.

19.10.2 Application of a Floor Dressing

Normal, commercially available polishes should not be applied to Polyflor ESD products, as they will inhibit the conductive properties.

Polishes described as 'antistatic' are classified by a different standard from that of the floorcovering, and should be treated as a standard polish in static control terms. Consequently, they should not be applied.

Conductive polishes which are approved by Polyflor can be applied in strict accordance with the manufacturer's instructions. Prior to application of a floor dressing, ensure that the floor is thoroughly scrubbed. This will ensure that there is a good key between the dressing and the surface of the flooring. Always discuss with our Technical Services staff before applying a conductive polish.

19.10.3 Regular maintenance

The frequency of each of the operations is dependent upon the type and intensity of traffic.

A. Sweep, mop sweep or dry vacuum, to remove dust and loose dirt.

B. Spot mop frequently. Stubborn black marks can be removed by using the centre disc of a scrubbing pad and a small amount of undiluted alkaline cleanser. Place the disc under the sole of the shoe and rub – this gives greater pressure. Rinse the area well with clean warm water and allow to dry.

C. Depending upon the end user requirement and the equipment available, one of the following methods should be used:

Using an alkaline or germicidal cleanser, diluted to the manufacturer's instructions, spray a fine mist onto the floor. Using a 165 to 500 rpm rotary machine and suitable spray cleaning pad, buff the floor to the desired shine. The dirt is picked up in the pad, which should be thoroughly cleaned after use. Failure to do so will result in a shiny, dirty floor.

or

Using an alkaline or germicidal cleanser, diluted to the manufacturer's instructions, mop the floor and allow to dry completely. Using a 500 to 2000 rpm rotary machine, buff the floor to the desired level of shine.

NOTE : When high speed burnishing, it is important that the machine is kept constantly moving. This avoids excessive heat build-up on the floor. As an additional precaution, we advise that a spray of clean water is used to help lubricate the pad.

19.10.4 Additional Information

1. Always ensure mops and pads are kept especially for the static control areas, to prevent a possible transfer of polish.

2. Always follow the Health and Safety guidance provided.

3. Regular cleaning is more beneficial to the floorcovering and more cost-effective than occasional heavy cleaning.

19.11 RUBBER FLOORCOVERINGS

19.11.1 Construction clean

After installation, wait 48 hours before proceeding with the construction/intensive clean.

A. Sweep or dry vacuum the floor to remove dust, grit and debris.

B. Apply a solution of alkaline cleanser, diluted as per the manufacturer's instructions, to the floor and leave for at least 5 minutes (or longer if manufacturer recommends) to react before proceeding.

C. Using a 150/175 rpm rotary machine fitted with fibre or nylon brushes, machine scrub the floor and then pick up the slurry with a mop or wet vacuum. The floor should then be rinsed with clean water and allowed to dry.

19.11.2 Application of a floor dressing

A. Prior to the application of a floor dressing, ensure that the floor is completely stripped, clean and free from any contaminants. This will ensure that there is a good key between the dressing and the surface of the floor.

B. Apply two or three thin coats of emulsion polish, in accordance with the manufacturer's instructions, with either a proprietary polish applicator or Kentucky mop wrung out to prevent over-application of polish. The polish should be applied up to 150mm from the edges of the room, and subsequent coats should be applied at 90° to the previous one. The final coat should be

applied right up to the edges of the room.

19.11.3 Routine maintenance

For ongoing maintenance, the frequency of each of the operations should be adjusted to suit the appearance expectations and the type and intensity of traffic.

A. Sweep or dry vacuum daily, to remove dust and loose dirt.

B. Spot mop frequently. Rinse the area with clean warm water and allow to dry.

C. As required (normally at least once per week) mop the floor using a floor maintainer, diluted as per the manufacturer's instructions, and leave to dry. If a shine is required, the floor should be buffed with a low-speed machine, typically 150/500 rpm, fitted with suitable fibre or nylon brushes.

Regular buffing of the floorcovering will enhance its appearance.

19.11.4 Removal of a floor dressing

An unsightly build-up of polish should be avoided. The polish should be removed regularly; the interval between application and removal depends on the wear conditions and the number of polish layers. (Normally, six months in heavy traffic areas.)

A. Apply a solution of emulsion polish stripper, diluted to the manufacturer's instructions, to the floor and leave for approximately 15 minutes.

B. Machine scrub with a 150/175 rpm machine fitted with a scrubbing brush, and then remove slurry with a wet vacuum. Thoroughly rinse the floor with clean warm water, pick up with a wet vacuum and allow to dry completely. The cycle of polish application and routine maintenance should then be repeated.

19.11.5 Additional Information

1. Always follow the Health and Safety guidance provided.
2. Regular cleaning is more beneficial to the floorcovering and more cost-effective than occasional heavy cleaning.
3. Polyflor homogeneous PUR and Polysafe ranges are suitable for steam cleaning on a periodic basis.

19.12 TIPS, HINTS AND PROBLEM SOLVING

The main objective of the tailored maintenance programme is to provide cost savings without any compromise in cleanliness and hygiene.

Bearing this in mind, the most important tip is to regularly assess the various locations and be flexible about the maintenance employed in them. If the floor in a particular location needs more attention, then ensure that it gets it sooner rather than later. If some areas seem over-maintained (with polish build-up, perhaps, in the non-trafficked areas), then pull back the maintenance level, but always monitor the situation to ensure that it remains within control. In addition, there are certain precautions which can be taken.

19.12.1 Asphalt and Tarmacadam

Where asphalt or tarmacadam is present immediately outside an entrance and there is not a sufficient dirt barrier system in place, use non-rubber traffic mats at least two paces wide. Staining of the floor may occur if traffic mats are not used.

19.12.2 Gravel Paths and Roadways

Traffic mats should also be considered when gravel paths or roadways are immediately outside an entrance. Mats must always be cleaned frequently.

19.12.3 Rubber Tyres etc

Antioxidants used in the manufacture of rubber can cause staining. Non-rubber traffic mats are recommended, as are tyre trays for car showrooms. Using black or dark brown floorcoverings will not prevent staining but will disguise it. Lighter coloured rubber can also be specified for appliance feet, trolley wheels etc.

19.12.4 Scratches

Prevention is the first step to protecting vinyl flooring from scratches:

1. Use mats at external doorways to reduce the trafficking of grit, dust and water into the building.
2. Furniture can cause scratches to a vinyl floor, therefore appropriate protection (felt pads, etc.) should be attached to the feet of tables and chair legs etc.
3. Keeping pets nails well clipped will reduce the likelihood of scratching from pets.

19.12.5 Points to Note

1. Regular light maintenance is more cost effective than periodic heavy maintenance and more beneficial to the floorcovering.
2. Always sweep, mop sweep or dry vacuum the floor regularly.
3. Always use clean equipment – dirty equipment only redistributes the dirt.
4. Do not mix cleaning products from different manufacturers –they may not be compatible.
5. Always remove any spillage immediately. Always remove excess water. It is not only dangerous but, on unwelded tile floors, the water can attack the adhesive and break the bond.
6. Do not use products containing pine gel or phenolic acid on Polyflor vinyl flooring. These can soften the vinyl surface and increase the possibility

of scuffing. Shrinkage of the vinyl can also occur in the long term.

7. Never apply a floor dressing which cannot easily be removed – such as polyurethane or acrylic sealers – unless approved by Polyflor.

8. Never deviate from the manufacturer's recommended dilution rates.

9. Always take precautions to prevent dark rubber from coming into contact with the flooring. If this cannot be avoided, select darker colours of floorcovering.

10. Never use black nylon carborundum abrasive pads on the flooring.

11. Only use water based floor maintenance products.

19.12.6 Problem Solving

It is our experience that most floorcare

complaints arise from a general comment that the floor is not as clean as expected. The most common reason is usually that the maintenance method being applied is not compatible with the type and level of traffic found. The table below contains more specific problems with their causes and our recommended actions.

19.13 HEALTH AND SAFETY

When using cleaning machines, polishes and chemicals, always follow the health and safety advice given by the relevant manufacturers.

When maintaining floors, wherever possible cordon off the area. This is much safer and will ensure that the job can be completed quicker.

Always use warning signs to advise that cleaning is in progress, especially in heavily trafficked areas and where wet cleaning methods are used.

COMMON PROBLEM	POSSIBLE CAUSE	RECOMMENDED ACTION
Powdering of polish/ excess of white dust.	Breakdown of polish due to either excessive use of alkaline cleansers, inadequate rinsing, use of bleaches or other harsh chemicals.	Strip off polish, thoroughly rinse and when dry, re-apply.
Poor gloss, streaks or patchy finish.	Polish could be applied to a dirty floor. Polish could have been applied with dirty equipment. A residue of alkaline cleanser is on the floor.	Strip off polish, thoroughly rinse and when dry, re-apply.
Polished floor is slippery.	Incorrect polish type applied. Application of too much or too little polish. Polish build up. Surface contaminants such as water or dust are not being removed. Cross trafficking of wax from other areas.	If polish is identified as the problem, strip off and re-apply. Ensure daily maintenance to remove dust and other surface contaminants. If cross trafficking is a problem, use walk off mats.
Sticky floors.	Polish may not be dry. There may be a detergent build up.	Strip off polish and re-apply. Ensure adequate rinsing after use of detergent to avoid build up.
Fading colour.	Equipment contaminated with bleach or bleach based products used.	Ensure all cleaning equipment is clean before use.

We strongly advise that a reputable professional maintenance company is used to provide chemicals and equipment. Always ask for help and advice sooner rather than later. A problem solved sooner is a problem solved cheaper.