

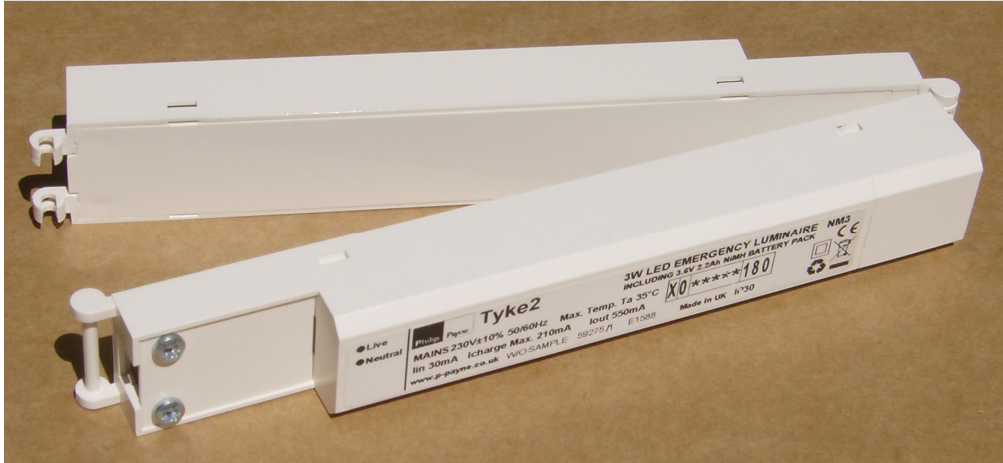

## TYKC203 RANGE

Emergency LED Downlighter



**Product:** TYKC203

**Description:** Recessed ceiling mounted emergency LED downlighter with corridor distribution lens.  
3 Hour non-maintained.

**Standards:**

- EN60598-1
- EN60598-2-22
- EN55015
- EN61547
- EN61000-3-2
- CE marked

**Specification:**

Total Weight: 350 g.

Mounting Position: Recessed ceiling.

Lamp: Cree XRE LED with corridor distribution lens.

Voltage / Current: Dependent upon gear. See table.

DALI Versions: Dedicated DALI interface for customer controlled monitoring & reporting.  
Also, stand-alone automatic testing in accordance with IEC62034 if not connected to a DALI system.

Autotest Versions: Stand-alone automatic testing in accordance with IEC62034.

Operating Temp: Min 0°C / Max 25°C.

IP Rating: IP65 below ceiling / IP30 above ceiling.

Luminous Flux: 140 lm.

Ceiling Cut-Out: 45mm diameter as standard.  
Maximum 55mm diameter is possible when using SL80RDLB extender bezel.  
Extender bezel is not included. Please order separately.

Void requirements: Minimum 155mm void depth (based on 12mm thick plasterboard and standard 45mm diameter cut-out).  
When using the SL80RDLB extender bezel a minimum 125mm void depth is possible (based on 12mm thick plasterboard and 55mm diameter cut-out). Extender bezel is not included. Please order separately.  
Voids must be free from obstructions for 470mm in the direction of installation to allow the gear housing to slide in. Please allow for at least 50mm air gap either side of the gear housing.

**Part Numbers Explained:**

TYKC203 - AA – B

Where: 'AA' designates the gear type. See table for options & codes.  
'B' designates the bezel finish. See table for options & codes.

**DIMENSIONS: TYKC003 DS/LN/YS**

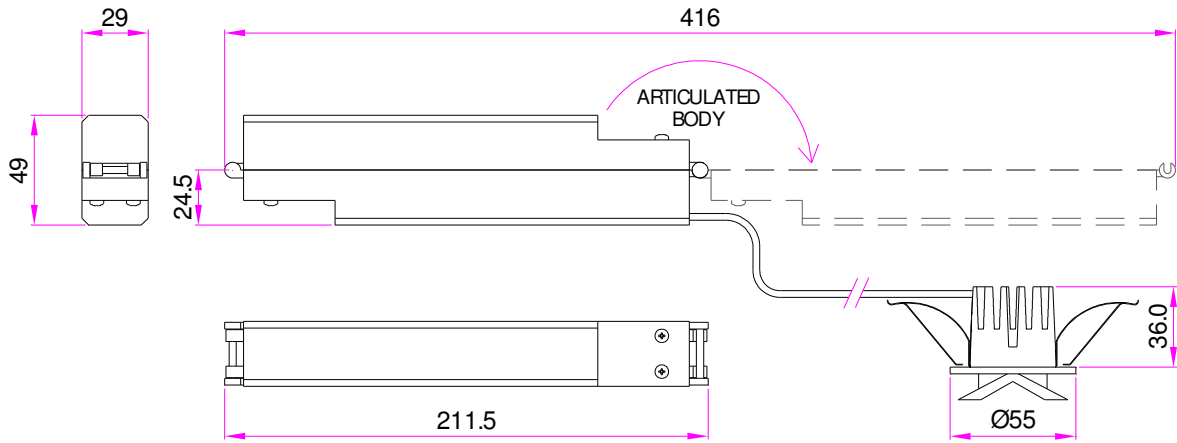

**DIMENSIONS: TYKC003 LA/LR**

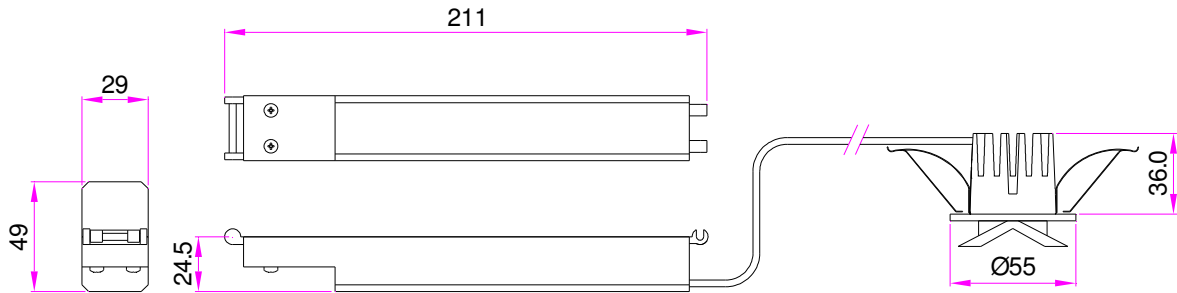

**Gear Options**

'AA' Code	Gear / Operation	Supply Current*
DS	230V AC ± 10% 50/60Hz emergency module with DALI interface & self-contained 3 hour NiMH battery pack. Non-maintained operation.	<100mA
LA	93-256V DC/AC 50Hz LED driver for use with central battery / static inverter.	<100mA @ 230V AC
LR	93-256V DC/AC 50Hz LED driver with 230V AC ± 10% 50Hz hold off relay for use with central battery / static inverter.	<100mA @ 230V AC
LN	230V AC ± 10% 50/60Hz emergency module with self-contained 3 hour NiMH battery pack. Non-maintained operation.	<100mA
PS	230V AC ± 10% 50/60Hz emergency module with 2 x normally closed potential free contacts & self-contained 3 hour NiMH battery pack. Non-maintained operation.	<100mA
YS	230V AC ± 10% 50/60Hz Autotest emergency module with self-contained 3 hour NiMH battery pack. Non-maintained operation.	<100mA

\*Supply current during normal luminaire operation, after inrush current on start up.

**Bezel Finish Options**

'B' Code	Finish
G	Grey RAL9006.
K	Black RAL9005.
W	White RAL9010.
Z	Special finish. Customer to specify on order.

## Luminaire Spacing's

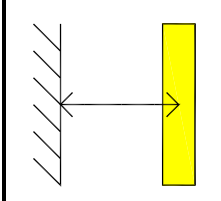
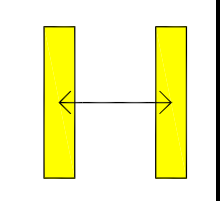
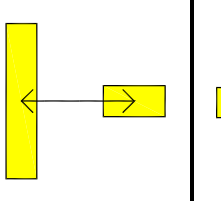
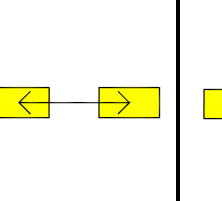
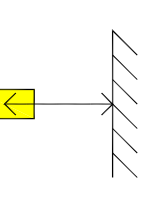
Ceiling Height					
2m Wide Escape Routes					
2.0 m	6.9 m	16.3 m	9.6 m	3.1 m	0.9 m
2.5 m	4.1 m	18.7 m	10.0 m	2.9 m	0.8 m
3.0 m	3.7 m	16.4 m	6.4 m	2.6 m	0.7 m
3.5 m	3.8 m	15.8 m	6.2 m	2.4 m	0.6 m
4.0 m	3.8 m	15.5 m	6.2 m	2.2 m	0.5 m

The spacing table is based on the following parameters:

- Maintenance factor = 0.80.
- Escape route illuminance on centre line = minimum 1.0 lx.
- Escape route illuminance on half of escape route width = minimum 0.5 lx.
- Escape route ratio of minimum to maximum illuminance on the centre line = maximum 40 : 1.
- Open area illuminance of empty core area, excluding a 0.5m border around the perimeter = minimum 0.5 lx.
- Open area ratio of minimum to maximum illuminance of empty core area, excluding a 0.5m border around the perimeter = maximum 40 : 1.

## Philip Payne Ltd

A SUBSIDIARY OF F.W. THORPE PLC  
Thornhill Road, Lode Lane, Solihull, B91 2HB, England.

Tel: 0121 705 2384

Fax: 0121 711 2469

E-mail: [mail@philippayne.co.uk](mailto:mail@philippayne.co.uk)

Website: <http://www.philippayne.co.uk>

Philip Payne Ltd registered in England No. 1361523



ISO 9001  
FM55077



TYKC203\_RANGE\_4