

## Smart Engine 185 - Tilttable Solid State Downlight

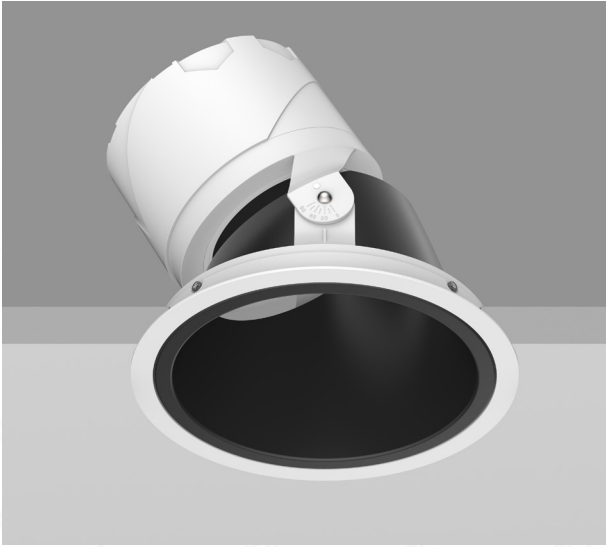

### Description

The Smart Engine allows for three adjustable beam angle settings of 12° and 24° via an integral push and click mechanism. High specification construction with interchangeable reflector. Deep recess light source serves to minimise glare and adjustable angle for wall wash. Protective spring clips which takes into consideration delicate ceilings. Plug and play connection to enable easy installation. CRI>80 to ensure light quality.

### Dimensions

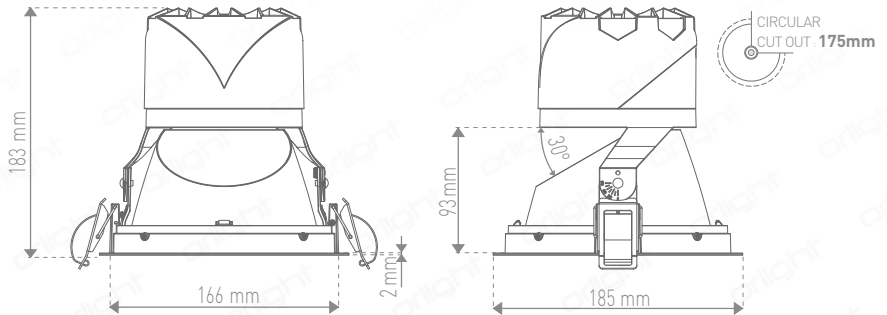

### Polar Report

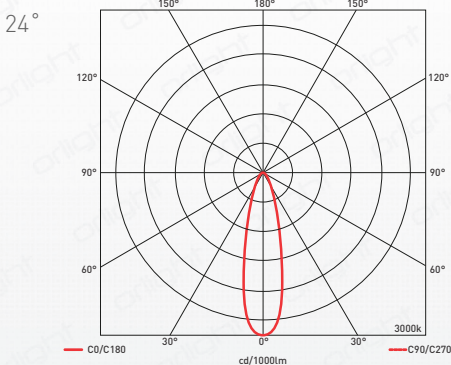
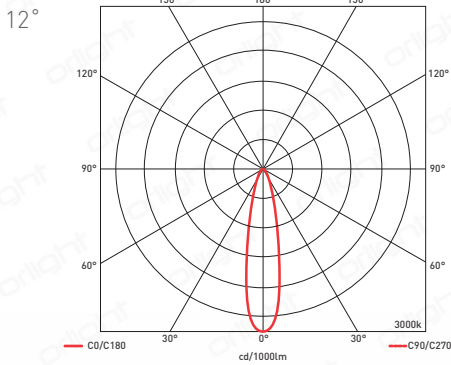

### Standards

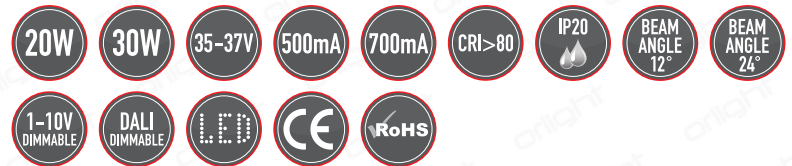

### Specifications

Chipset	CREE CXB 1820			
Dimming Options	Switched, 1-10V; DALI			
Driver	Inline			
Voltage	35-37V			
Power Consumption	17W Fixture Power/20W Curcuit Power		26W Fixture Power/30W Curcuit Power	
Current	500mA		700mA	
Colour Temperature	3000K	4000K	3000K	4000K
Light Output ~	2052lm	2079lm	2350lm	2438lm
lm Per Watt ~	95lm/W	104lm/W	78lm/W	81lm/W
CRI	>80			
Beam Angle	12°, 24°			
Binning	2 Step MacAdams Ellipse			
Chip Life TM-21	L70 > 55,400 hours			
Cutout Required	175mm			
IP Rating	IP20			
Weight	920g			
Finish	White - RAL9016 (With interchangeable baffles - Black, White & Chrome)			

### Colourmetrics

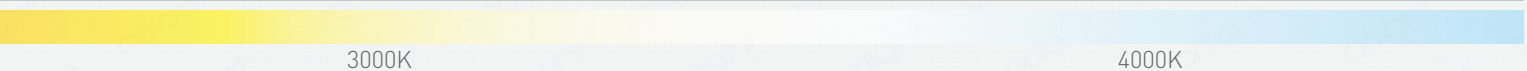

3000K								4000K							
R1	R2	R3	R4	R5	R6	R7	R8	R1	R2	R3	R4	R5	R6	R7	R8
81	90	97	82	81	87	85	62	81	88	93	83	81	83	88	67
R9	R10	R11	R12	R13	R14	R15		R9	R10	R11	R12	R13	R14	R15	
11	76	81	68	83	98	74		14	70	81	60	82	96	76	

## Exploded View

### Retaining Housing



Engine + 12° & 24° **Adjustable** Fresnel Lens



### 30° Tilttable Frame

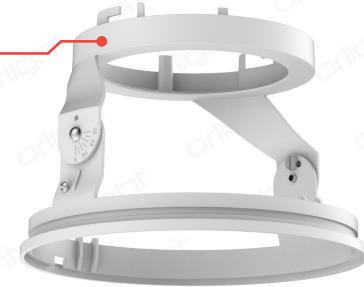
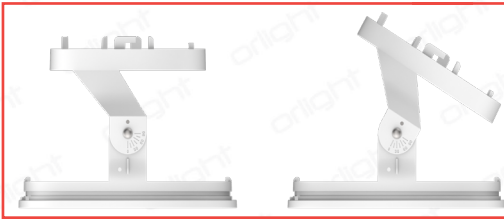

Interchangeable Baffle

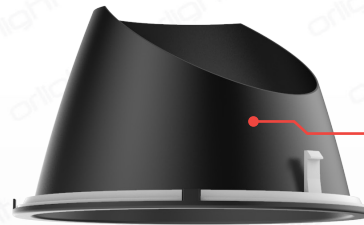

## Baffle Finishes (All Baffles Included)



BLACK



WHITE



CHROME

Product Coding: Example: SMARTENGINE185-WH-4000K-DALI

CODE	FINISH	COLOUR TEMP	DIMMING OPTION	EMERGENCY OPTION
SMARTENGINE185	WH - (RAL 9016 WHITE)	3000K	SWITCHED	EM
		4000K	1-10V	EM
			DALI	EM

\*Refer to Accessories

\*Accessories

DRIVERS
DR40LCM (Adjustable Current)
DR40LCM (Adjustable Current)
DALI DR40LCM (Adjustable Current)