



Solutions for Transfer and Care



Gemini Assisted Bath

Product Care & User Operating Instructions

Technical Product Specification

Minimum rim height	620mm
Lift range (combined)	680mm
Fill volume	220 Litres
Time to fill	4.0 min at 2 bar pressure
Total weight (including 80kg patient)	280kg
Electric/hydraulic motor	Electro Hydraulic
Electrical	24 Volt DC battery/transformer
Minimum dimensions (W x H x L)	750 x 620 x 1700mm
Maximum dimensions (W x H x L)	750 x 1300 x 1700mm
Internal dimensions (rim) (W x D x L)	550 x 400 x 1480mm
Internal dimensions (base) (W x D x L)	520 x 400 x 1410mm
Safe working load (bath)	150kg

Dimensions

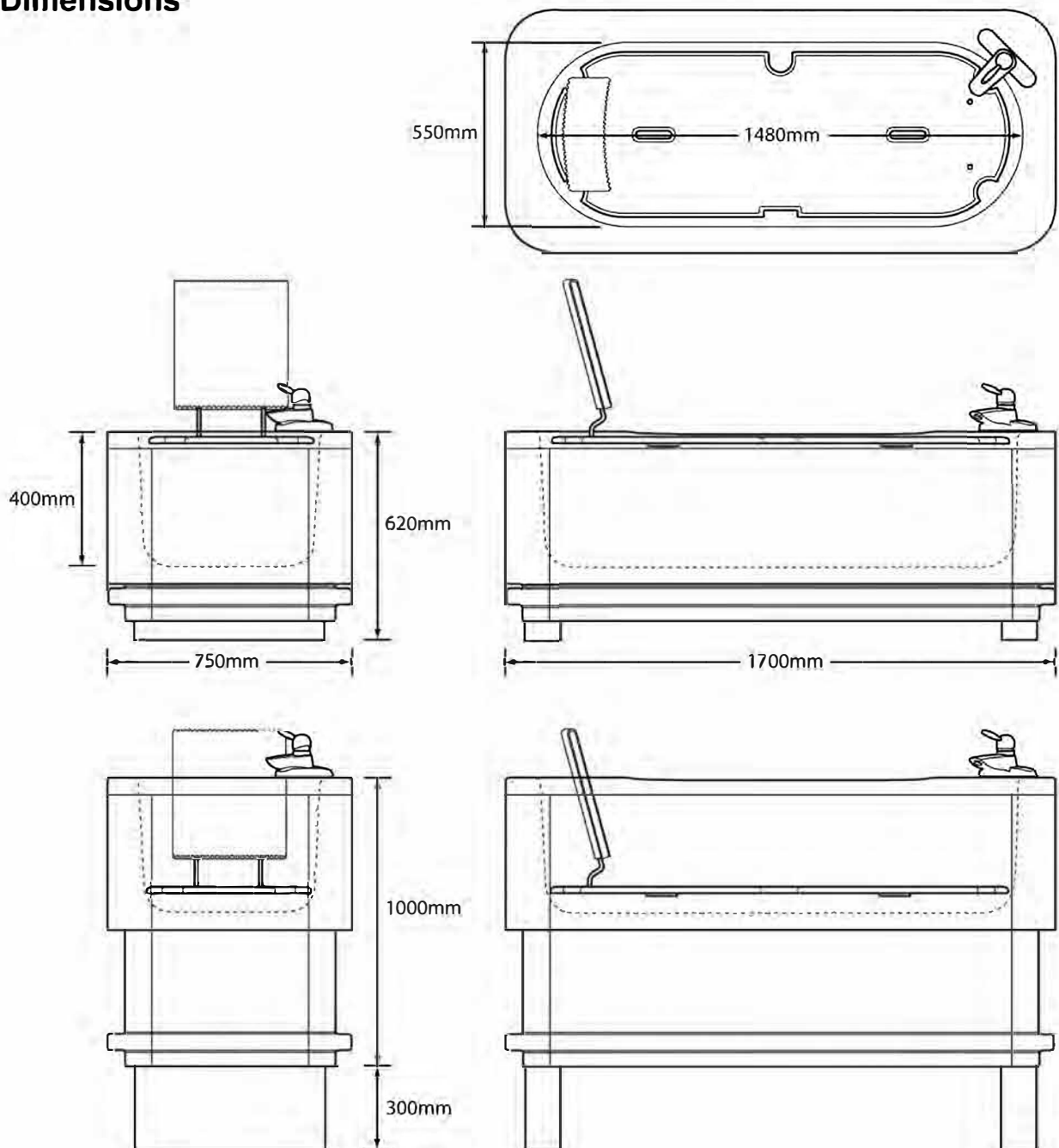

Fig. 1

Warranty

Our bath products are guaranteed for a period of twelve months from the date of delivery. All parts are covered against defects that may arise as the result of faulty materials, inferior workmanship or construction.

The baths are not covered for any problems that may arise from the installation or site planning unless carried out by engineers from Abacus Healthcare. Any consequence arising from unskilled or incorrect handling of the product is not covered by this guarantee.

The following items, when supplied by Abacus Healthcare are guaranteed for a period of twelve months from the date of supply for the parts only (labour costs are not covered).

- Taps and mixers
- Shower hoses, shower heads and shower brackets.
- Flexible pipes including waste outlet, hot and cold supply.

Hot and cold taps and mixer taps are proprietary fittings and as such carry a standard manufacturer's warranty.

Note: Thermostatic mixing valves must be adjusted for the appropriate discharge temperature by the installer. These require regular maintenance for which Abacus engineers are available.

• Electrical

All electrical components fitted to Aquanova baths are CE marked to comply with current European Standards.

Electrical items must not be replaced with alternative components without the authorisation of Abacus Healthcare.

Failure to obtain such authorisation will exempt the Company from any liability to action for further failure.

Safety Instructions

Always ensure the equipment is operated by trained staff.

Always ensure the mains electricity is switched on.

Always keep users hands away from moving parts.

Always ensure that the bather's hands and feet are kept away from the cut outs in the platform.

Always check the position of the bather on the platform before raising/lowering the bath.

Always have the equipment serviced regularly (see Service Level Agreement).

Always ensure the shower head is returned to its holder when not in use.

Never use the bath for any purpose other than that for which it has been designed.

Never leave the bath with the platform in a raised position.

Never allow other equipment such as hoists to contact the bath forcibly as this may cause damage.

Never allow items such as the shower head to remain beneath the platform when raising the bath.

Regularly clean the bath using non-abrasive cleaners.

Whirlpool use and safety

Ensure you have a minimum of 50mm of water above all jets before switching on your whirlpool.

Do not run unmixed hot water directly on to the suction fitting.

Do not let anything cover the suction fitting during use, especially you.

Do not try to put your finger in a jet whilst the whirlpool is working.

Do not leave children unattended in the bath with the whirlpool system switched on.

Do not wash your hair in a bath fitted with a whirlpool system when the system is working.

Do not wash animals in a bath fitted with a whirlpool system.

Do not modify your whirlpool in any way. This would result in the guarantee becoming invalid and could result in the system becoming dangerous.

Check, especially after children have used the bath, that they have not pushed small toys or other objects into the jets or suction fitting.

Check regularly that all debris is cleared from around the suction fitting.

Ensure that adequate access is left for maintenance and servicing.

Do not switch on your whirlpool without any water in the bath since this will damage the whirlpool pump.

Do not use large amounts of standard bubble bath in the water since this will fill the room with soap bubbles

Maintenance

After each use: Dissolve a sterilising tablet into the bath water and then run the system prior to sending the water to waste.

Clean the bath and fittings using a soft cloth and non abrasive cleaner with anti-bacterial agent

Monthly: Whirlpool sanitisation using Abacus Healthcare approved cleaner. Test RCDs

Annually: Servicing by an approved company in accordance with the manufacturer's instructions.

Operating Instructions

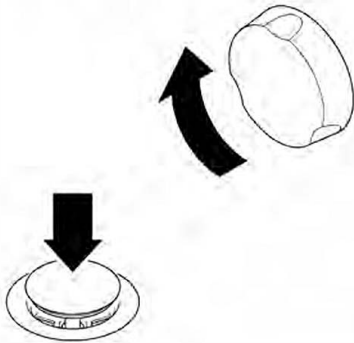

Fig. 2

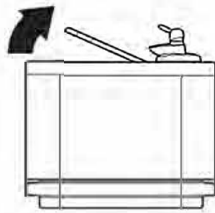

Fig. 3



Fig. 4

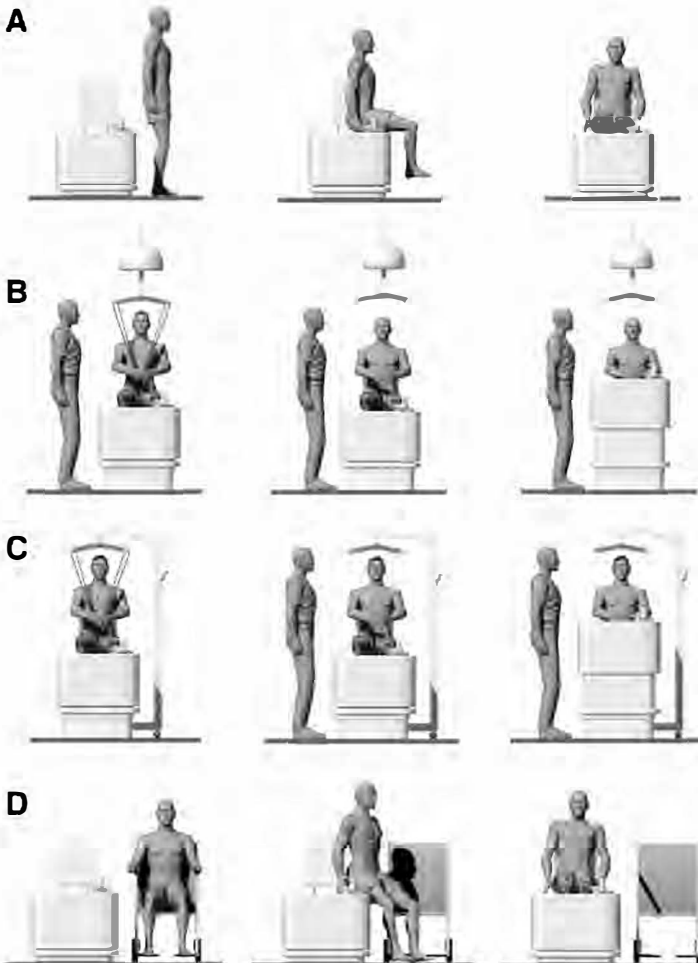

Fig. 5

1. To close the pop up waste rotate the chrome turn handle clockwise until the waste plug locates in the outlet (fig. 2).

2. Fill the bath with water to your required level. The platform may be tilted to observe the depth of water (fig. 3).

3. Check the temperature of the water.

4. Set the bath level at the height appropriate for transfer of the bather (as low as possible for an ambulant transfer or raised to allow access for a portable hoist) (fig. 4).

5. Allow/assist the bather to transfer onto the platform (a bed type transfer for an ambulant bather) (fig.5).

A: Ambulant

B: Ceiling Track Hoist

C: Mobile/Portable Hoist

D: Wheelchair

Operating Instructions (continued)

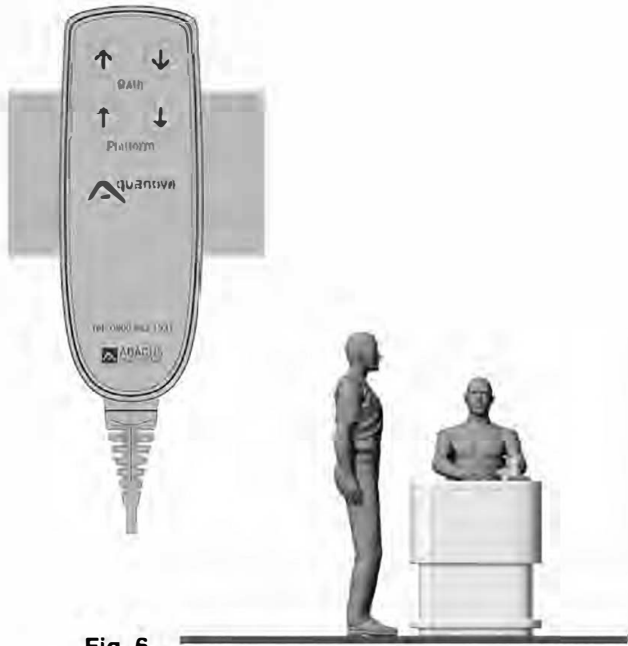

Fig. 6



Fig. 7



Fig. 8





Fig. 9

6. Raise the bath, full of water, around the platform and bather by pressing and holding the bath  icon (fig. 6).

The bather will now be immersed in the water.

7. Raise the bath and platform to the most comfortable height for the Carer to provide assistance by pressing the platform  icon on the handset (fig.7).

8. When bathing is completed lower the bath full of water to below the level of the platform by pressing and holding the bath  icon on the membrane pad on the bath rim (fig. 8).

The platform may be used for drying/dressing prior to transfer (or at anytime). The height of the platform may be adjusted to the optimum height for the carer by pressing and holding the platform  icon

9. Assist to towel dry/dress the bather.

10. Lower the whole bath to the position as in 4, for easy transfer (ambulant or hoist) by pressing and holding the bath  icon (fig. 9).

11. Allow/assist the bather to transfer off the platform (see transfers - fig. 5).

12. Empty the bath using the pop up waste turning handle.

13. Make the bath ready for the next bather (clean, disinfect etc).

Locking Devices

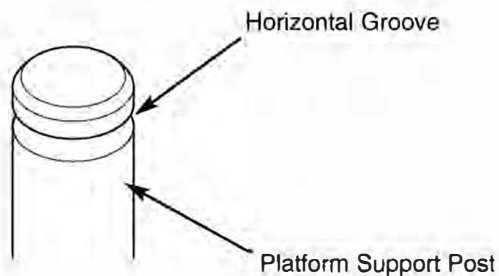

Fig. 8

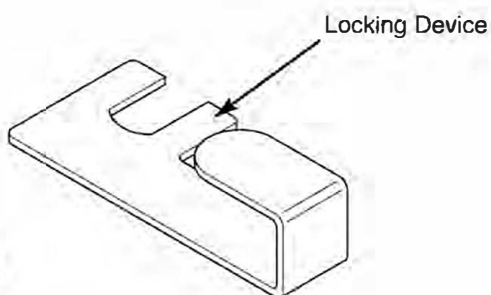

Fig. 9

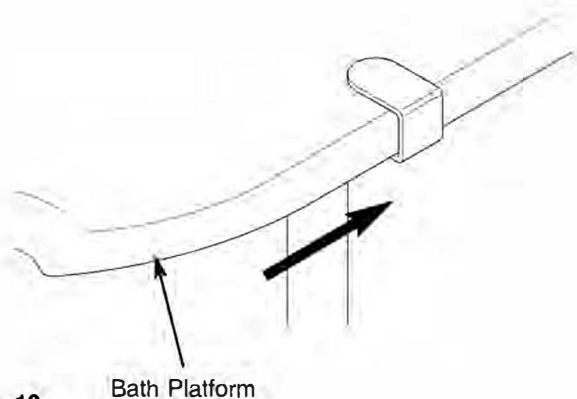

Fig. 10

Platform Locking Device

1. The platform locking device is designed to connect the platform to one stainless steel platform support post during bathing. It will prevent the platform pivoting when the bath (if full of water) is raised.

2. Identify where the support post with a horizontal groove is situated (fig. 8).

3. Place the locking device between the end of the bath and the support post you have identified.

4. Holding the locking device with the cranked end upwards (fig. 9), slide the device along the platform with the length of the device below the platform (fig. 10).

5. Continue to slide the locking device along the platform until it engages with the groove on the support post (fig. 10).

6. Check the platform is locked and will not raise when the bath rises.

NOTE: Do not raise the platform to attach the locking device.

Whirlpool Operating Instructions

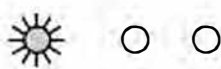

Power indication Light.

The Red light indicates that the power is on. This must be illuminated before the whirlpool functions will operate.



Stop & Starts Whirlpool.

Press once to Start and again to Stop the whirlpool. The system is fitted with a safety pump immobiliser that prevents the whirlpool from running without sufficient water in the bath.



Whirlpool Function Light.

Green light indicates that the whirlpool is running.



Bath fill Reminder.

Whilst the bath is empty, press and hold down until the beeper sounds then release the button.

Fill the bath with water. When a certain level is reached the beeper will sound. Press any key to silence the beeper. (Note: the bath fill reminder is not a substitute for checking the bath whilst filling). The Power light will flash to indicate the bath fill reminder has been activated.



Water Level Indication Light.

When no water is present the Light is Red. If the bath fill reminder has been activated the light will flash. When water is present the light turns Green.



Power Adjustment.

To regulate the power of the whirlpool jets press and hold the button. The power will cycle up and down, when the desired massage setting is reached release the button.



Pulsing Massage.

Press to start the pulsing massage press again to stop.



Aqua Light (Optional).

Press to turn on, press again to turn off. To change Colour, turn the light on and off (double press). The light goes through each colour in sequence. The last option cycles through all the colours automatically.

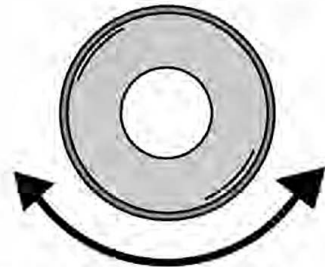
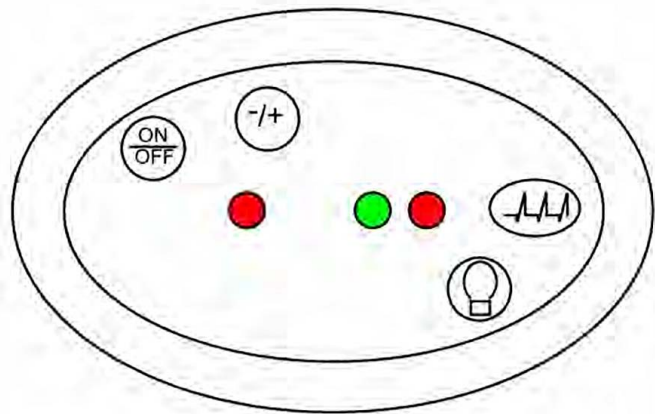

Adjustable Jets

The jets can be adjusted by rotating the bezel until the desired pressure is reached. Do not turn all jets off at once.