

# Shower and Floor Gullies Channel Drain and Tile Drain

**M'ALPINE**  
Plumbing Products

SECTION

2



Shower and Floor Gullies, Channel Drain and Tile Drain

# General Information

## Shower and Floor Gullies

- M<sup>C</sup>Alpine has responded to market conditions and customer demand by producing an extensive range of gullies suitable for shower and wet floor areas
- The comprehensive range of gullies is suitable for concrete and suspended timber floors finished with sheet flooring, tiles or stone
- Two-piece gullies enable the gully to be plumbed prior to installation of timber floors and wet room floor formers
- M<sup>C</sup>Alpine gullies are ideal for domestic wet rooms, Lifetime Homes, disabled adaptations, student accommodation, bathroom pods, hotels, hospitals, secure accommodation and sport and leisure facilities
- Manufactured in ABS to the highest quality, M<sup>C</sup>Alpine gullies comply to EN 1253-2:2003
- Flow rates of 48 litres per minute exceed the minimum requirement of EN 1253-2:2003 and are variable dependent on the grating or cover plate used
- Range of Trapped Shower Gullies (TSG) available with 50mm, 60mm and 75mm water seal, Untrapped Shower Gullies (USG) for use with pumped waste and Valve Shower Gullies (VSG) for use in floors where depth is restricted
- Choice of horizontal or vertical outlet
- All gullies have top access for easy cleaning
- Choice of white plastic, polished stainless steel and chrome plated finishes for tiles, gratings, clamp rings and cover plates

## Channel Drain for Tiled Floors

- The Channel Drain is suitable for concrete and suspended timber floors finished with tiles or stone
- Manufactured in grade 304 stainless steel
- Choice of brushed or polished finish cover plate reversible to accommodate tiles up to 8mm
- Frame height adjustable to suit tiles up to 16mm

## Tile Drain for Wet Floor Areas

- The Tile Drain is suitable for concrete and suspended timber floors finished with tiles or stone
- Manufactured in grade 304 stainless steel
- Choice of 150mm square stainless steel designer tiles reversible to accommodate tiles up to 8mm
- Frame height adjustable to suit tiles up to 16mm



Code TSG50T6SS

### Sheet Flooring

- ① Choice of cover plates with or without securing screws
- ② Cover plate and dip tube assembly. Choice of cover plate finishes available
- ③ Removable sediment cup
- ④ Temporary cover plate. For use during installation as a plug for preliminary air test. Will protect gully from damage by foot traffic and prevent site debris entering the drainage system
- ⑤ Clamp ring with 4 x M6 stainless steel screws
- ⑥ Four indentations suitable for size 8 countersunk screws
- ⑦ Gully body with 2" BS EN 1329-1:2000 solvent weld horizontal outlet
- ⑧ 2" x 1½" BS EN 1329-1:2000 socket reducer



### Tile or Stone Floors

- ① Choice of tiles and gratings with or without securing screws
- ② Removable dip tube
- ③ Removable sediment cup
- ④ Dust cap/extension ring. For use during installation to prevent site debris entering the drainage system. The fitting can also be used for raising the height of the tile
- ⑤ Clamp ring for waterproofing membrane and solvent welding tile. The clamp ring has weep holes to allow any moisture at this level to discharge back into the gully and is secured by 4 x M6 stainless steel screws
- ⑥ Four indentations suitable for size 8 countersunk screws
- ⑦ Gully body with 110mm vertical outlet
- ⑧ 110mm x 2" BS EN 1329-1:2000 solvent weld reducer

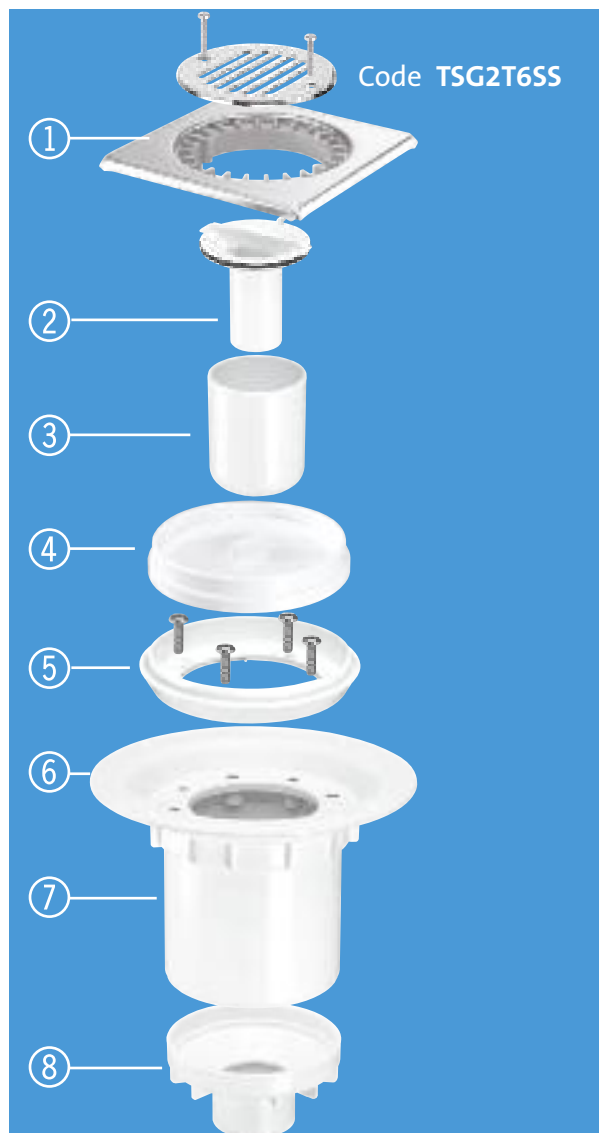

■ The two products shown illustrate the versatility of the McAlpine range of Trapped Shower Gullies. See pages 34-38 for the full range of Trapped and Untrapped Gullies

# Gullies for use with Sheet Flooring

## Trapped Gullies

Choose the appropriate gully body and cover plate finish required

White Plastic  
Clamp Ring and  
Cover Plate

Polished  
Stainless Steel  
Clamp Ring and  
Cover Plate

CP Brass Clamp  
Ring, CP  
Stainless Steel  
Grated Cover  
Plate

Gullies without securing screws allow for easier access

Do not pour drain cleaner down these products



**75mm Water Seal Trap** with 2" BS EN 1329-1:2000 solvent weld horizontal outlet and 2" x 1½" socket reducer. Overall height 130mm



With  
securing  
screws

**TSG1-WH**

**TSG1SS**

**TSG1SS-SL-SC**

Without  
securing  
screws

**TSG1WH-NSC**

-

**TSG1SS-SL-NSC**

**50mm Water Seal Trap** with 2" BS EN 1329-1:2000 solvent weld horizontal outlet and 2" x 1½" socket reducer. Overall height 100mm

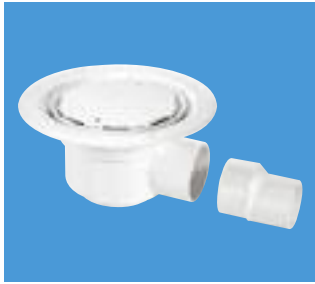

With  
securing  
screws

**TSG50WH**

**TSG50SS**

**TSG50SS-SL-SC**

Without  
securing  
screws

**TSG50WH-NSC**

-

**TSG50SS-SL-NSC**

**Two-Piece Gully, 50mm Water Seal Trap** with 2" BS EN 1329-1:2000 solvent weld horizontal outlet, 2" swivel outlet fitting and 2" x 1½" socket reducer. Overall height 100mm



With  
securing  
screws

**TSG52WH**

**TSG52SS**

**TSG52SS-SL-SC**

Without  
securing  
screws

**TSG52WH-NSC**

-

**TSG52SS-SL-NSC**

**75mm Water Seal Trap** with 110mm vertical outlet and 110mm x 2" BS EN 1329-1:2000 solvent spigot outlet. Overall height 130mm



With  
securing  
screws

**TSG2WH**

**TSG2SS**

**TSG2SS-SL-SC**

Without  
securing  
screws

**TSG2WH-NSC**

-

**TSG2SS-SL-NSC**

**Trapped Gullies**

Choose the appropriate gully body and cover plate finish required

Gullies without securing screws allow for easier access

Do not pour drain cleaner down these products

White Plastic  
Clamp Ring and  
Cover Plate

Polished  
Stainless Steel  
Clamp Ring and  
Cover Plate

CP Brass Clamp  
Ring, CP  
Stainless Steel  
Grated Cover  
Plate

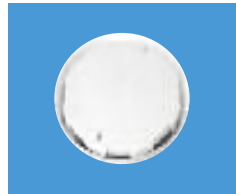

**50mm Water Seal Trap** with 1½" BS EN 1329-1:2000 solvent weld side inlet for the discharge from a wash hand basin with a 110mm vertical outlet to fit 110mm pipe socket or vertical 1½" solvent weld pipework. Overall height 130mm



With  
securing  
screws

**TSG3-WH**

**TSG3SS**

**TSG3SS-SL-SC**

Without  
securing  
screws

-

-

**TSG3SS-SL-NSC**

Gullies show white cover plates for illustrative purposes only

**Untrapped Gullies**

**Untrapped Gully** with 22mm horizontal plain outlet for use with pumped waste. Overall height 44.5mm



With  
securing  
screws

**USG1WH**

**USG1SS**

**USG1SS-SL-SC**

**Untrapped Gully** with 2" BS EN 1329-1:2000 solvent weld vertical outlet and 2" x 1½" socket reducer. Overall height 70.5mm



With  
securing  
screws

**USG2WH**

**USG2SS**

**USG2SS-SL-SC**

**Untrapped Gully** with 1½" BS EN 1329-1:2000 solvent weld horizontal outlet. Overall height 70.5mm



With  
securing  
screws

**USG3WH**

**USG3SS**

**USG3SS-SL-SC**

Gullies show white cover plates for illustrative purposes only. See page 52 for gully flow rates

# Gullies for use with Tiled or Stone Floors where a Waterproofing

## Trapped Gullies

Choose the appropriate gully body and cover plate finish required

Gullies without securing screws allow for easier access

Do not pour drain cleaner down these products

150mm Square Polished Stainless Steel Tile with removable Grid

150mm Square White ABS Tile with removable Grid

125mm Diameter Polished Stainless Steel Grating with removable Grid

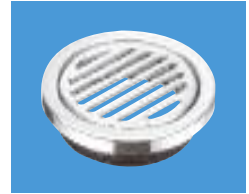
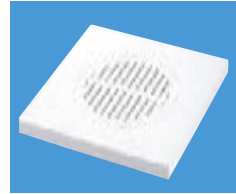
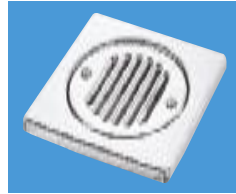

**75mm Water Seal Trap** with 2" BS EN 1329-1:2000 solvent weld horizontal outlet and 2" x 1½" socket reducer. Overall height 130mm



With securing screws

**TSG1T6SS**

-

-

Without securing screws

**TSG1-T150SS**

**TSG1T6WH**

**TSG1-R125SS**

**50mm Water Seal Trap** with 2" BS EN 1329-1:2000 solvent weld horizontal outlet and 2" x 1½" socket reducer. Overall height 100mm



With securing screws

**TSG50T6SS**

-

-

Without securing screws

**TSG50-T150SS**

**TSG50T6WH**

**TSG50-R125SS**

**Two-Piece Gully, 50mm Water Seal Trap** with 2" BS EN 1329-1:2000 solvent weld horizontal outlet, 2" swivel outlet fitting and 2" x 1½" socket reducer. Overall height 100mm



With securing screws

**TSG52T6SS**

-

-

Without securing screws

**TSG52-T150SS**

**TSG52T6WH**

**TSG52-R125SS**

**75mm Water Seal Trap** with 110mm vertical outlet and 110mm x 2" BS EN 1329-1:2000 solvent spigot outlet. Overall height 130mm



With securing screws

**TSG2T6SS**

-

-

Without securing screws

**TSG2-T150SS**

**TSG2T6WH**

**TSG2-R125SS**

Gullies show square stainless steel cover plates for illustrative purposes only. All above gullies supplied with white plastic clamp ring. See page 52 for gully flow rates

### Untrapped Gullies

Choose the appropriate gully body and cover plate finish required

Gullies without securing screws allow for easier access

Do not pour drain cleaner down these products

150mm Square Polished Stainless Steel Tile with removable Grid

150mm Square White ABS Tile with removable Grid

125mm Diameter Polished Stainless Steel Grating with removable Grid

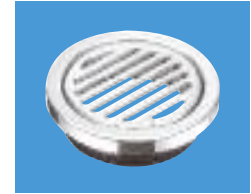
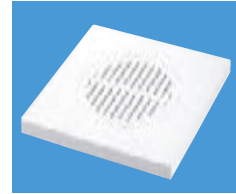
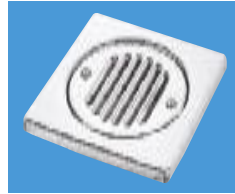

**Untrapped Gully** with 22mm horizontal plain outlet for use with pumped waste. Overall height 44.5mm



With securing screws

**USG1T6SS**

-

-

Without securing screws

**USG1-T150SS**

-

-

**Untrapped Gully** with 2" BS EN 1329-1:2000 solvent weld vertical outlet and 2" x 1½" socket reducer. Overall height 70.5mm



With securing screws

**USG2T6SS**

-

-

Without securing screws

**USG2-T150SS**

-

-

**Untrapped Gully** with 1½" BS EN 1329-1:2000 solvent weld horizontal outlet. Overall height 70.5mm



With securing screws

**USG3T6SS**

-

-

Without securing screws

**USG3-T150SS**

-

-

## Two-Piece Gully and Gully with Non-Return Valve

- Two-piece gullies have been specifically designed for use with timber floors and floor formers and can be plumbed prior to the installation of the floor or former. See pages 34-40 for product range
- The Valve Shower Gully (VSG) has been developed to satisfy customer demand for a shallow gully suitable for installation in floors where depth is restricted



Code VSG1WH-NSC



Code TSG52T6SS

# Gullies with Non-Return Valve for use where floor depth is restricted

## SECTION 2

- The Valve Shower Gully (VSG) has been developed to satisfy customer demand for a shallow gully suitable for installation in floors where depth is restricted
- The overall height of the VSG1 is only 75mm and the valve is a substitute for a regulatory water seal trap which cannot be incorporated in a gully of this height
- There are currently no regulations to cover the use of anything other than water seal traps in domestic drainage systems. Although valves have been in existence for some time, it is advisable to seek guidance from the local building control department prior to use
- The valve acts as a non-return valve, the weight of the water discharge will open the valve and it will reseal when the discharge has ceased thus prohibiting foul air from entering the dwelling
- The valve eliminates the release of foul air due to back flow
- The valve can be easily removed to facilitate easy cleaning of the gully
- The VSG range has a minimum flow rate of 30 litres per minute when tested with a 15mm head of water



**White Plastic Clamp Ring with Cover Plate** and 1½" BS EN 1329-1:2000 solvent weld horizontal outlet. Overall height 75mm

	Code
With securing screws	<b>VSG1WH</b>
Without securing screws	<b>VSG1WH-NSC</b>



**Two-Piece Gully, White Plastic Clamp Ring with Cover Plate** and 1½" BS EN 1329-1:2000 solvent weld horizontal outlet. Overall height 85mm

With securing screws	<b>VSG52WH</b>
----------------------	----------------



**150mm Square Polished Stainless Steel Tile with removable Grid and Securing Screws** 1½" BS EN 1329-1:2000 solvent weld horizontal outlet. Overall height 75mm

	<b>VSG1T6SS</b>
--	-----------------

## Gullies with Non-Return Valve for use where floor depth is restricted



### Two-Piece Gully, 150mm Square Polished Stainless Steel Tile with removable Grid and Securing Screws

1½" BS EN 1329-1:2000 solvent weld horizontal outlet.  
Overall height 85mm

Code

VSG52T6SS

## Gullies with Anti-Ligature Grating for use with Sheet Flooring

- Shower gullies with anti-ligature grating have been designed for use in secure accommodation
- Grating is Home Office approved
- All gullies supplied with security screwdriver bit to release anti-ligature grating



**75mm Water Seal Trap** 2" BS EN 1329-1:2000 solvent weld horizontal outlet and 2" x 1½" socket reducer. CP brass clamp ring with polished stainless steel anti-ligature grating.  
Overall height 130mm

Code

TSG1-ANTI/LIG



**50mm Water Seal Trap** 2" BS EN 1329-1:2000 solvent weld horizontal outlet and 2" x 1½" socket reducer. CP brass clamp ring with polished stainless steel anti-ligature grating.  
Overall height 100mm

Code

TSG50-ANTI/LIG

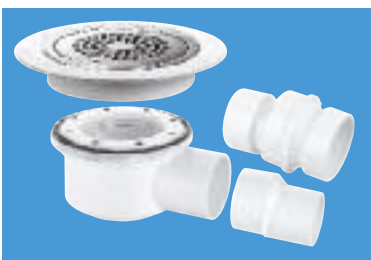

**Two-Piece Gully, 50mm Water Seal Trap** 2" BS EN 1329-1:2000 solvent weld horizontal outlet, 2" swivel outlet fitting and 2" x 1½" socket reducer. CP brass clamp ring with polished stainless steel anti-ligature grating.  
Overall height 100mm

Code

TSG52-ANTI/LIG



**75mm Water Seal Trap** with 110mm vertical outlet and 110mm x 2" BS EN 1329-1:2000 solvent weld reducer. CP brass clamp ring with polished stainless steel anti-ligature grating.  
Overall height 130mm

Code

TSG2-ANTI/LIG

# Top Access Shower Traps for use with Sheet Flooring, Tiled or Stone Floors

## SECTION 2



### For Sheet Flooring

**19mm Water Seal Trap** with 1½" universal compression outlet, white plastic clamp ring and cover plate with securing screws.  
Overall height 138mm

Code

TSG1WH-STW1R



### For Sheet Flooring

**50mm Water Seal Trap** with 1½" x 90° swivel Multifit outlet bend, white plastic clamp ring and cover plate with securing screws.  
Overall height 138mm

Code

TSG1WHSTW295



### For Sheet Flooring

**50mm Water Seal Resealing Trap** with 1½" x 90° swivel Multifit outlet bend, white plastic clamp ring and cover plate with securing screws.  
Overall height 167mm

Code

TSG1WH-STW2R



### For Tiled or Stone Floors

**19mm Water Seal Trap** with 1½" universal compression outlet, 150mm square polished stainless steel tile with removable grid and securing screws.  
Overall height 138mm

Code

TSG1T6SS+STW1-R



### For Tiled or Stone Floors

**50mm Water Seal Trap** with 1½" x 90° swivel Multifit outlet bend, 150mm square polished stainless steel tile with removable grid and securing screws.  
Overall height 138mm

Code

TSG1T6SSSTW295



### For Tiled or Stone Floors

**50mm Water Seal Resealing Trap** with 1½" x 90° swivel Multifit outlet bend, 150mm square polished stainless steel tile with removable grid and securing screws.  
Overall height 167mm

Code

TSG1T6SS-STW2R

# Tiles and Gratings

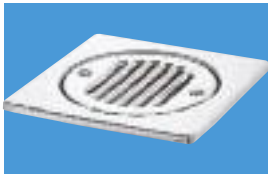

**150mm Square Polished Stainless Steel Tile** with removable grid and securing screws. Tile has ABS spigot adaptor for solvent welding to clamp ring

Code

**FGTOP6SS**

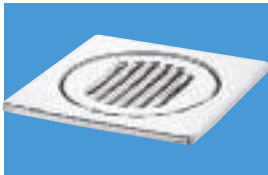

**150mm Square Polished Stainless Steel Tile** with removable grid. Tile has a removable ABS spigot adaptor for solvent welding to clamp ring leaving a rubber gasket to fit inside 110mm pipe

Code

**FGT150TOP**



**150mm Square White ABS Tile** with removable grid. Tile has spigot adaptor for solvent welding to clamp ring

Code

**MDTOP-WH**



**200mm Square White ABS Tile** with removable grid. Tile has spigot adaptor for solvent welding to clamp ring

Code

**MDTOP20-WH**

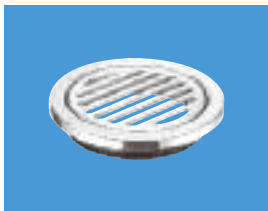

**125mm Diameter Polished Stainless Steel Grating** with removable grid. Grating has a removable ABS spigot adaptor for solvent welding to clamp ring leaving a rubber gasket to fit inside 110mm pipe. Suitable for stone shower bases

Code

**FGTR125STOP**

## 150mm Stainless Steel Tile with Internal Non-Return Valve

- Suitable for wet floor areas where 4"/110mm drainage pipework has been installed to the finished floor level and no waterproofing membrane is required
- The internal non-return valve prevents foul air entering the building
- The 150mm square tile can be fitted on a trapped or untrapped drain
- Ideal for replacement and repair of a damaged tile or problem systems
- Push-fit or solvent weld spigot suitable for direct connection to 4"/110mm drainage pipework
- Valve easily removed for cleaning and maintenance work

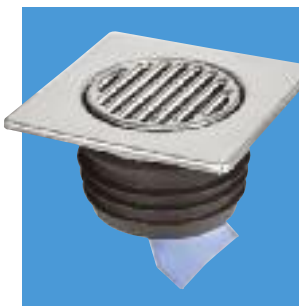

150mm square stainless steel tile with silicone non-return valve and removable grid including removable stainless steel mesh filter

Code

**FGT150-SV-110**

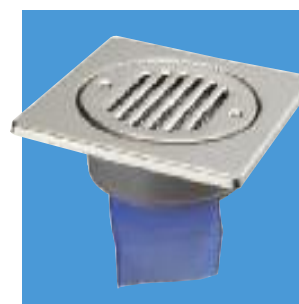

150mm square stainless steel tile with silicone non-return valve and securing screws. ABS solvent weld connection to 4"/110mm drainage pipework

Code

**FGT150-SV-110S**



# Gullies suitable for Concrete Ground Floors where a Waterproofing Membrane is not required

## SECTION 2

### Trapped Gully Bodies



**Multi-Drain - 60mm Water Seal Universal Trapped Floor Gully** manufactured in grey ABS with 2<sup>2</sup>/<sub>3</sub>" solvent weld horizontal outlet. Height can be extended by solvent welding length of 110mm PVC pipe between gully body and tile. Inlet connections are for solvent welding to 1<sup>1</sup>/<sub>2</sub>" ABS/PVC pipe, internal fit or 2" ABS/PVC pipe, external fit. Overall height 152mm

For Tiles and Gratings see page 42

Code

MD100



**Multi-Drain - 60mm Water Seal Universal Trapped Floor Gully** manufactured in grey ABS with 3" solvent weld horizontal outlet. Height can be extended by solvent welding length of 110mm PVC pipe between gully body and tile. Inlet connections are for solvent welding to 1<sup>1</sup>/<sub>2</sub>" ABS/PVC pipe, internal fit or 2" ABS/PVC pipe, external fit. Overall height 152mm

For Tiles and Gratings see page 42

Code

MD100-3

### Adaptors for Inlet and Outlet Connections

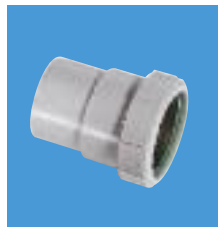

**Multi-Drain Inlet Fitting**  
2" solvent weld x 2" universal compression

Code

MD200



**Multi-Drain Outlet Fitting**  
3" solvent weld x 110mm solvent weld

Code

MD400

### Untrapped Gullies with Top Access for Tiled Floors



**Untrapped Gully** with 1<sup>1</sup>/<sub>2</sub>" BS EN 1329-1:2000 solvent weld horizontal outlet and 150mm square polished stainless steel tile with removable grid and securing screws. Overall height 68mm

Code

FD90-T6SS



**Untrapped Gully** with 1<sup>1</sup>/<sub>2</sub>" BS EN 1329-1:2000 solvent weld horizontal outlet and 150mm square white ABS tile with removable grid. Overall height 68mm

Code

FD90-T6WH

*Do not pour drain cleaner down these products*

# Channel Drain for Tiled Floors

- Supplied with 1½" x 50mm water seal trap with top access for easy cleaning
- Available with polished or brushed finished grade 304 stainless steel cover plate
- Cover plate reversible to accommodate tiles up to 8mm
- Frame height adjustable to suit tiles up to 16mm
- Flow rate 54 litres per minute. Calculated under a constant 120mm head of water
- Supplied with adjustable height support legs for concrete floor installations. Adjustable height 128-170mm
- There are two MCAAlpine ranges: Standard and Slimline channel drains. Both are available in a choice of lengths, designs and finishes

## Standard Channel Drain for Tiled Floors

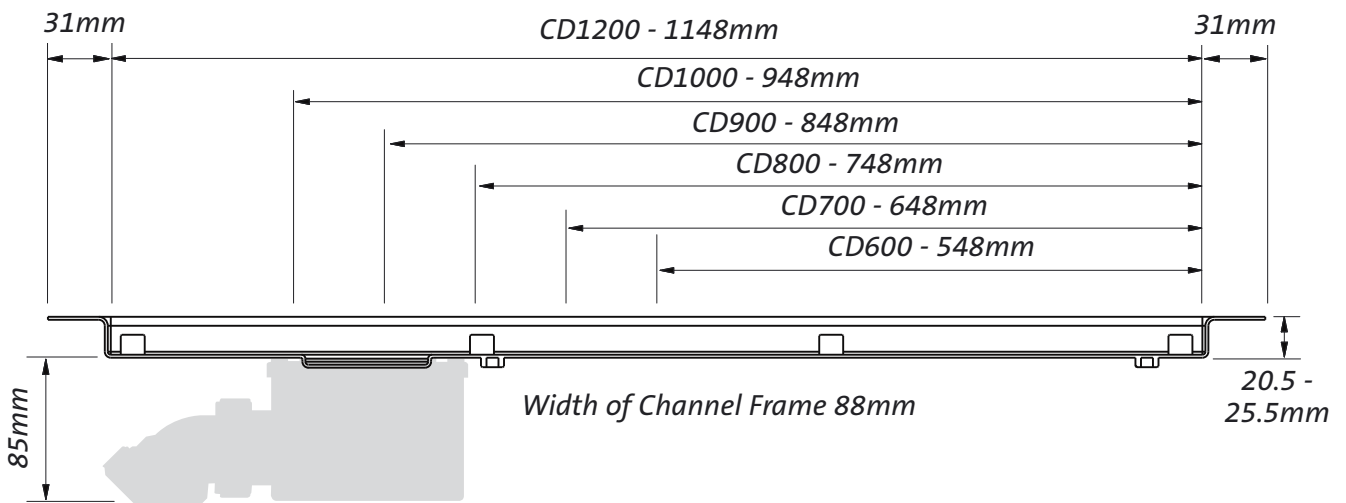

Channel Drain for Tiled Floors



*Do not pour drain cleaner down these products*



**Standard Channel Drain** with brushed finish cover plate

Code	<b>CD600-B</b>
Code	<b>CD700-B</b>
Code	<b>CD800-B</b>
Code	<b>CD900-B</b>
Code	<b>CD1000-B</b>
Code	<b>CD1200-B</b>



**Standard Channel Drain** with grid (brushed finish)

Code	<b>CD600-SQ</b>
Code	<b>CD700-SQ</b>
Code	<b>CD800-SQ</b>
Code	<b>CD900-SQ</b>
Code	<b>CD1000-SQ</b>
Code	<b>CD1200-SQ</b>

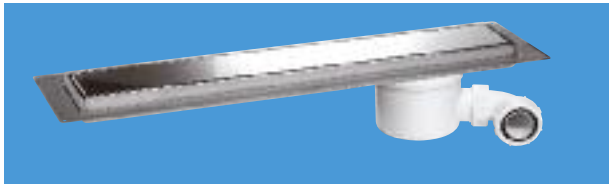

**Standard Channel Drain** with polished finish cover plate

Code	<b>CD600-P</b>
Code	<b>CD700-P</b>
Code	<b>CD800-P</b>
Code	<b>CD900-P</b>
Code	<b>CD1000-P</b>
Code	<b>CD1200-P</b>

*Cover plates available separately on request*



Scan here to view our Installation video or visit our website [www.mcalpineplumbing.com](http://www.mcalpineplumbing.com)



*Do not pour drain cleaner down these products*

# Channel Drain for Tiled Floors

## Slimline Channel Drain for Tiled Floors

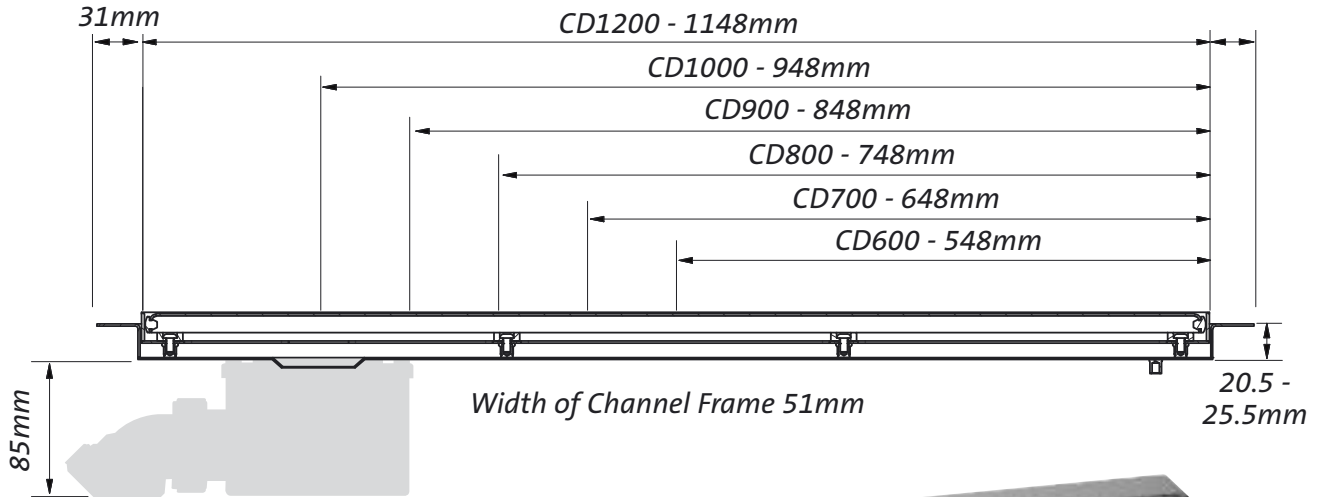

**Slimline Channel Drain** with brushed finish cover plate

Code	<b>CD600-O-B</b>
Code	<b>CD700-O-B</b>
Code	<b>CD800-O-B</b>
Code	<b>CD900-O-B</b>
Code	<b>CD1000-O-B</b>
Code	<b>CD1200-O-B</b>

*Cover plates available separately on request*

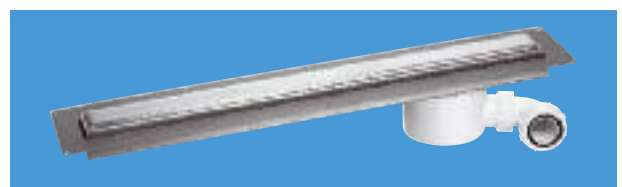

**Slimline Channel Drain** with polished finish cover plate

Code	<b>CD600-O-P</b>
Code	<b>CD700-O-P</b>
Code	<b>CD800-O-P</b>
Code	<b>CD900-O-P</b>
Code	<b>CD1000-O-P</b>
Code	<b>CD1200-O-P</b>

*Do not pour drain cleaner down these products*

- Tiles suitable for 50mm water seal traps as illustrated
- Tiles supplied with brushed or polished finish. All in grade 304 stainless steel
- Tiles reversible to accommodate tiles up to 8mm
- Tile frame dimension 150mm square
- Frame height adjustable to suit tiles up to 16mm
- Supplied with adjustable height support legs for concrete floor installations



Code **TILE-PLAIN-B**



Code **TILE-PLAIN-P**



**50mm Water Seal Trap Body** with 1½" Multifit outlet. Adjustable height 105-168mm. Flow rate 34 l/min\*

Code **ST90-70B**



**50mm Water Seal Trap Body** with 1½" Multifit outlet. Adjustable height 120-168mm. Flow rate 42 l/min\*

Code **ST90-HP2B**



**50mm Water Seal Trap Body** with 2" Multifit outlet. Adjustable height 120-168mm. Flow rate 50 l/min\*

Code **ST90-HPB**

Tile Drain for Wet Floor Areas

\*Flow rate calculated under a constant 15mm head of water

**Do not pour drain cleaner down these products**

# Installation Guidelines

## General Notes and Guidance for Shower Gullies

- All Trapped (TSG), Untrapped (USG) and Valve (VSG) shower gullies can be used in concrete or suspended timber floors
- All gullies are ideal for shower and wet floor areas
- Fixing instructions are supplied with each gully

## Sheet Flooring

- Set the gully into the floor and ensure that the top surface of the gully flange is flush with, or slightly below, the floor surface on which the flooring is to be laid
- Ensure the gully body is fully supported, do not rely solely on the gully flange for support
- A watertight seal between the underside of the sheet flooring and the gully flange must be achieved with the use of a neutral sealant (not an acetoxy sealant) prior to the clamp ring being screwed into position

## Tiled Floors

- The minimum dimension between the gully flange and top surface of the gully tile or grating, which requires to be flush with the flooring, is 13mm. This dimension cannot be reduced but if required the gully tile or grating can be raised. To do this remove the centre from the dust cap/extension ring and solvent weld the extension ring to the upstand of the clamp ring. If additional height is required an appropriate length of 110mm pipe can be solvent welded between the extension ring and the underside of the gully tile or grating
- Ensure the gully body is fully supported, do not rely solely on the gully flange for support
- A good quality waterproofing membrane should be employed to prevent water penetration to the floor structure. Ensure that the underside of the membrane is sealed to the gully flange and secured by the clamp ring to the gully body
- The clamp ring has weep holes to allow any moisture to discharge into the gully

## Stone Shower Bases and Trays

- Gullies can be used with stone or marble shower bases and trays. The illustration shows how a 125mm diameter polished stainless steel grating can be connected to a 50mm water seal gully
- A waterproofing membrane should be fitted between the gully body and the underside of the base or tray

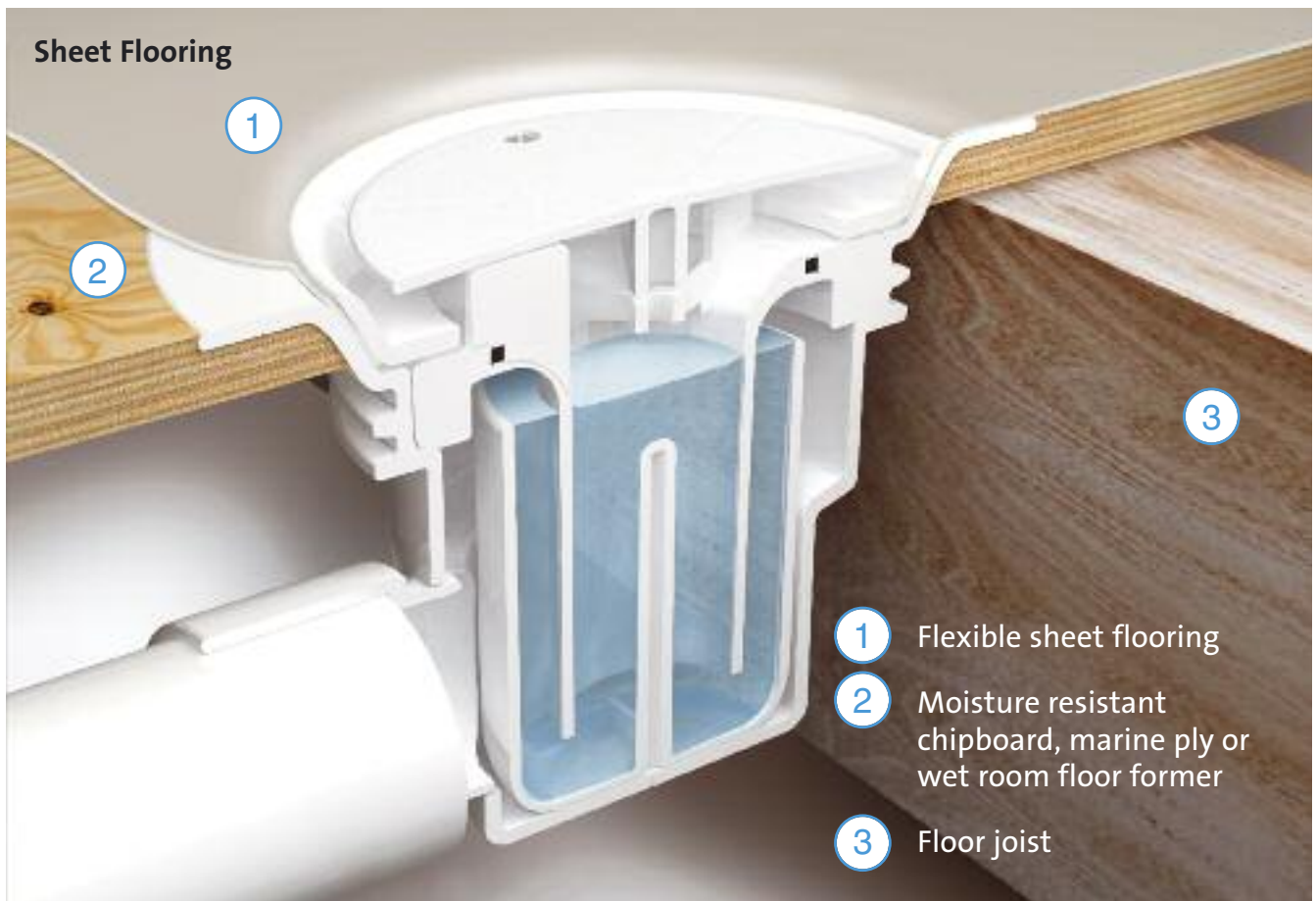

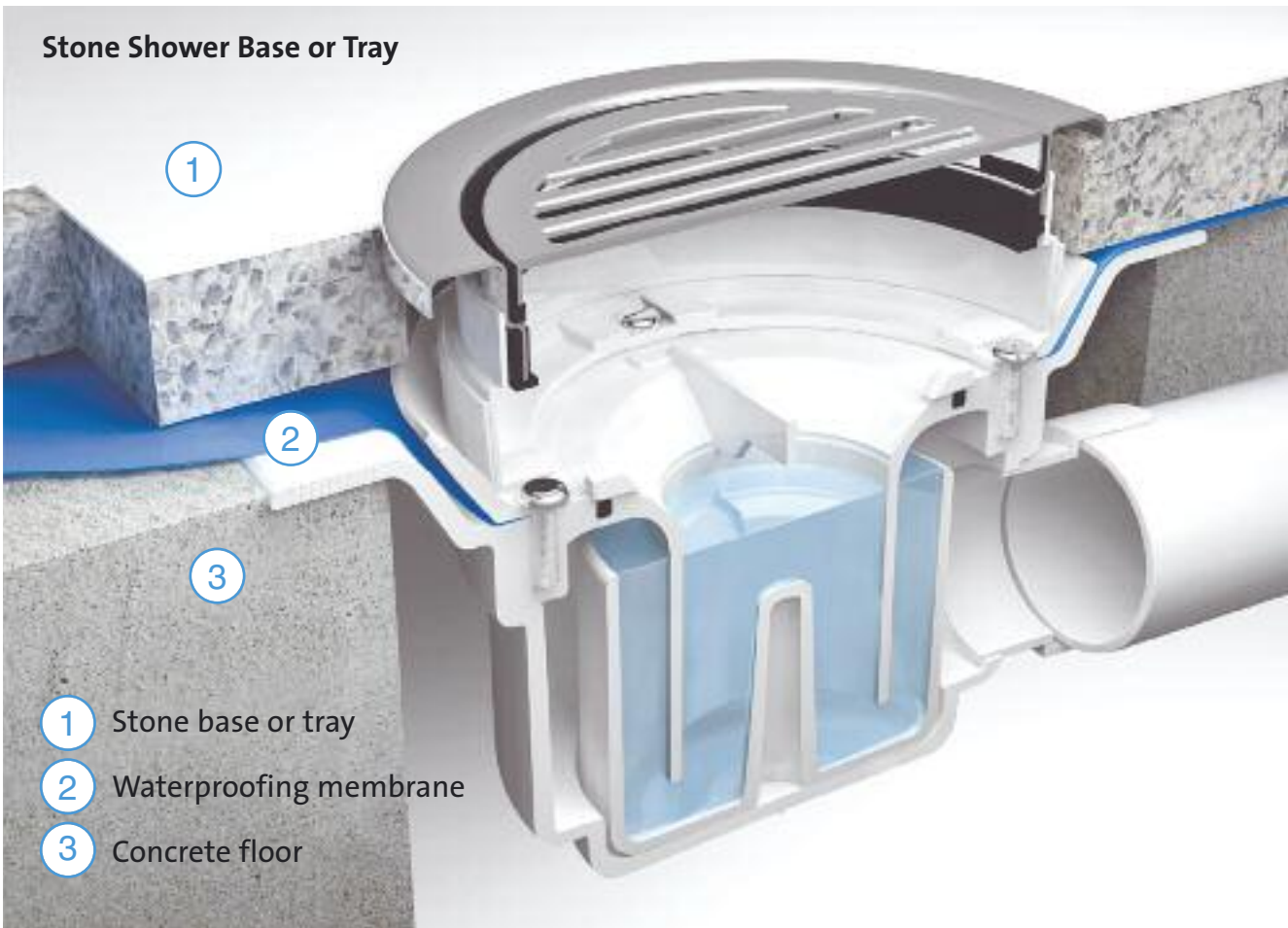
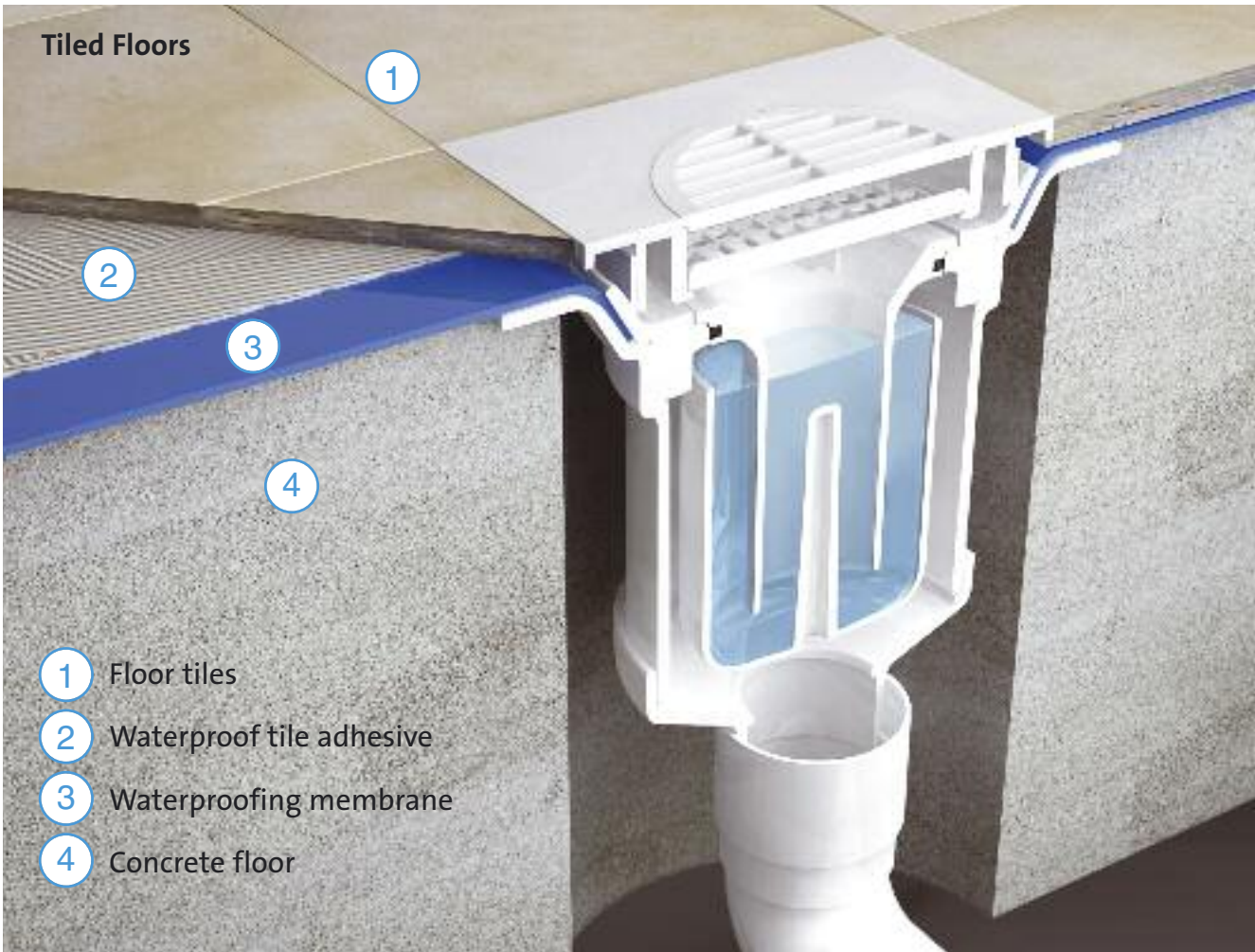

# Conversion Kits

## Conversion Cover Plate with 1½" Universal Pipe Boss



For use with TSG1, TSG50, TSG52 and TSG2 shower gullies for sheet flooring. Used to seal off gully or to convert to a drain connection to allow for installation of bath waste. By refitting the cover plate and dip tube the drain reverts to a trapped gully

Code

**CPTSG**

## Conversion Kits to enable Gullies except MD100, MD100-3 and FD90 to be converted for different floor finishes



**Converts any TSG1 or TSG2 Gully** from tiled to a sheet flooring gully with dip tube, CP brass clamp ring, CP stainless steel grated cover plate without securing screws

Code **FGTR118TOP**



**Converts any TSG1 or TSG2 Gully** to a tiled floor gully with white ABS clamp ring, 150mm square white ABS tile with removable grid and dip tube

Code **TSGCONV**



**Converts any TSG50 or TSG52 Gully** to a sheet flooring gully with dip tube, CP brass clamp ring, CP stainless steel grated cover plate with securing screws

Code **FGTR118TOP-50**



**Converts any TSG1 or TSG2 Gully** to a tiled floor gully with white ABS clamp ring, 150mm square polished stainless steel tile with removable grid, securing screws and dip tube

Code **TSGCONVSS**



**Converts any TSG1 or TSG2 Gully** to a sheet flooring gully with white plastic clamp ring, cover plate and dip tube

Code **TSGCONTV**



**Converts any TSG1 or TSG2 Gully** to a sheet flooring gully with polished stainless steel clamp ring, cover plate and dip tube

Code **TSGCONTVSS**

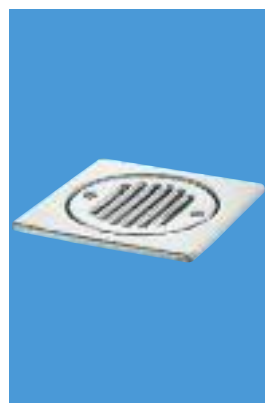

**Converts any Gully with a 150mm White Plastic Tile** to a gully with a 150mm square polished stainless steel tile with removable grid and securing screws

Code **FGTOP6SS**

### Stopper for TSG Dip Tubes



For use with trapped shower gullies TSG1, TSG50, TSG52 and TSG2 models only, either sheet flooring or tiled floor versions. When after installation the gully is not going to be used there is a possibility that the water seal will evaporate. The stopper when inserted into the dip tube will prevent foul air entering the building

Code

**TSGSTOP**

### Filter Mesh

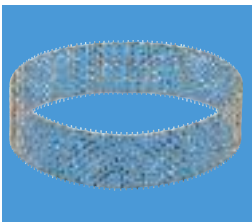

**Filter Mesh** to suit USG1 range of untrapped gullies

Code

**MESH-1**

### Stability Leg



**Optional Stability Leg** to suit USG1 range of untrapped gullies

Code

**USGLEG1**

All M<sup>c</sup>Alpine gullies surpass the minimum required flow rate when tested in accordance with clause 5 of BS EN 274-2:2002. **The flow rate is tested under a constant 15mm head of water** and will vary depending on the tile grating cover plate used.

Code	Flow Rate Litres per minute	Code	Flow Rate Litres per minute	Code	Flow Rate Litres per minute
TSG1-ANTI/LIG	31	TSG3SS-SL-NSC	>70	USG1SS-SL-SC	10
TSG1-R125SS	56.9	TSG3SS-SL-SC	>70	USG1-T150SS	10
TSG1SS	50	TSG3-T150SS	>70	USG1T6SS	10
TSG1SS-SL-NSC	53.6	TSG3T6SS	>70	USG1WH	10
TSG1SS-SL-SC	53.6	TSG3T6WH	>70	USG1WH-NSC	10
TSG1-T150SS	55	TSG3WH	65.1	USG2SS	68
TSG1T6SS	55	TSG50-ANTI/LIG	44	USG2SS-SL-NSC	68
TSG1T6SS+STW1R	35	TSG50-R125SS	54.3	USG2SS-SL-SC	68
TSG1T6SSSTW295	32	TSG50SS	48	USG2-T150SS	68
TSG1T6SS-STW2R	37	TSG50SS-SL-NSC	50.3	USG2T6SS	68
TSG1T6WH	55	TSG50SS-SL-SC	50.3	USG2WH	68
TSG1-WH	53	TSG50-T150SS	53.6	USG3SS	65
TSG1WH-NSC	53	TSG50T6SS	52.6	USG3SS-SL-NSC	65
TSG1WH-STW1R	35	TSG50T6WH	52.5	USG3SS-SL-SC	65
TSG1WHSTW295	32	TSG50WH	50.5	USG3-T150SS	65
TSG1WH-STW2R	37	TSG50WH-NSC	51	USG3T6SS	65
TSG2-ANTI/LIG	>70	TSG52-ANTI/LIG	44	USG3WH	65
TSG2-R125SS	>70	TSG52-R125SS	54.3	VSG1T6SS	30
TSG2SS	>70	TSG52SS	48	VSG1T6WH	30
TSG2SS-SL-NSC	>70	TSG52SS-SL-NSC	50.3	VSG1WH	30
TSG2SS-SL-SC	>70	TSG52SS-SL-SC	50.3	VSG1WH-NSC	30
TSG2-T150SS	>70	TSG52-T150SS	53.6	VSG52T6SS	36
TSG2T6SS	>70	TSG52T6SS	52.5	VSG52T6WH	36
TSG2T6WH	>70	TSG52T6WH	52.5	VSG52WH	36
TSG2WH	>70	TSG52WH	50.5	VSG52WH-NSC	36
TSG2WH-NSC	>70	TSG52WH-NSC	51		
TSG3-R125SS	>70	USG1SS	10		
TSG3SS	64.5	USG1SS-SL-NSC	10		