

PVC-U TRUNKING

A range of cost-effective
PVC-U cable containment for
general wiring installations.



PVC-U TRUNKING

PVC-U TRUNKING

Our PVC-U cable containment systems are easy to install, light to handle and cost-effective to use. We have a wide range of PVC-U trunking solutions in different heights, designs, cable capacities for the distribution of power and data; making it an excellent choice of material for the majority of commercial, education and healthcare environments. PVC-U is a self-extinguishing material and therefore helps to stop the spread of fire.

We are very proud that our PVC-U products have been manufactured using 80%* recycled material during the last year. This equates to the equivalent of 300 double decker buses worth of PVC-U that we have prevented going to landfill!



All we are changing is the environment, using recycled PVC-U reduces greenhouse gases by 20 times when compared to virgin PVC-U. Reassuringly, we have been using recycled material for over 20 years, we take our effect on the environment very seriously and are doing our best to minimise our impact on it.

(* Figures based on our production usages from 1/1/18 to 31/12/18)

Standard colour

The standard colour for each Marshall-Tufflex range is shown within each relevant product information section, although solid white RAL 9003 is our most popular colour option for PVC-U.

The below table identifies the relevant RAL colour reference for all our standard colour options, dependent on product range. However we would be happy to quote for any other colour requirements, please see the Special Colours section.

Standard Colours		
WH	RD	BN
WH: White RD: Red BN: Brown		

Material	Standard colour	Colour code suffix	RAL
PVC-U	Solid White	WH	9003
	Red	RD	3020
	Brown	BN	8017

Please note: it is dependent on the product range as to which colour is available as standard.

Special colours

To help enhance the style of an installation, different variations of solid colour are sometimes required.

We can provide special colours in either a solid PVC-U solution or a painted solution dependent on your client's preference. All special colour requirements will need to be specified as a RAL colour.

Please note: due to different processes and materials utilised, it may not always be possible to obtain an exact colour match between the extruded and moulded product.

Please note: these colours are made to order and therefore are subject to set up charges and a longer lead time. For more information and a quotation contact our Technical Team on +44 (0)1424 856688.



Bio antimicrobial trunking



Where hygiene is a priority, Marshall-Tufflex has a solution with integral antimicrobial properties that can be incorporated within the PVC-U perimeter trunking and deliver ongoing antimicrobial protection that prevents 99.9% of harmful bacteria.

Because the Marshall-Tufflex Bio trunking solution is integral to the PVC-U material, there is no reduction in effectiveness of the trunking throughout its life – even if it is scratched or damaged.

Bench Trunking is available in Bio but not available as standard and is made to order and therefore subject to set up charges and a longer lead time. For more information and a quotation contact our Technical Team on +44 (0)1424 856688.

PVC-U trunking

Mini trunking

10 x 8mm to 38 x 38mm

Range of small size containment for general wiring. Standard and self-fix options are available with 1 or 2 compartments. Punched profiles for single compartment and self-fixing trunking now available.



Page 100

Sovereign Plus

75 x 20mm

Skirting trunking with one piece cover.

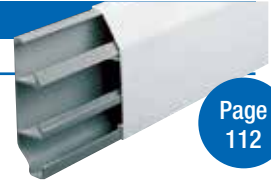

Page 112

Maxi trunking

50 x 50mm to 150 x 150mm

A mid-size containment that can be subdivided for general wiring. Larger sizes can accommodate wiring accessories.



Page 106

Sceptre trunking

100 x 40mm

Smallest trunking system that can still accept a full range of standard wiring accessories. Suitable for unobtrusive, multiple outlet, surface installations.



Page 113

Cornice trunking

50 x 50mm

A cornice containment system for distributing services around ceiling perimeters. This system can be used with Mini Trunking to supply switch drops and pendant lighting.



Page 111

Bench trunking

105 x 105mm

Robust angular containment for distributing services on the desktop or workbench. Can accept standard wiring accessories.

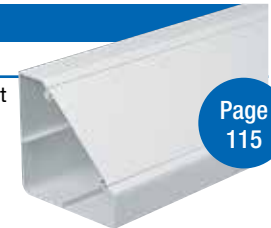

Page 115

Environmental & sustainability



- We use recycled PVC-U in our manufacturing process, reducing carbon emissions in doing so.
- Research has shown that the use of recycled PVC offers a 20-fold reduction in greenhouse gas (GHG) emissions compared to virgin product. 100% recyclable material and has a long life cycle. We encourage our products to be recycled at the end of their useful life.
- PVC-U is a cost-effective, sustainable choice and comparable with other materials such as steel, aluminium, copper and wood.
- Virgin grade PVC-U has the lowest oil content of a commodity plastic.
- No increase in dioxin emission from Municipal Waste Incineration. No phthalates used in manufacture of PVC-U or FR-ABS.
- Lead-free formulations are used for mouldings and extrusions.
- No use of cadmium-based stabilisers or pigments.

EMI protection



- Some PVC-U systems are available with a coating that provides effective screening against electromagnetic interference with no reduction in cable capacity.

Fire performance



- The fire rating for PVC-U is excellent* and PVC-U has all the characteristics required for Fire Escape Time.
- Highly resistant to ignition.
- Does little to contribute to the spread of fire and is classified to Building Regs: Class 0.
- Chars and is self-extinguishing.
- Has a low rate of smoke production during the early stages of a fire.
- Acts as an effective barrier to flame spread from malfunctioning electrical components within systems.
- Does not produce flaming droplets or burning debris.

*see the independent report at www.beama.org.uk

Note: you may use the rule on the left of this page to check profile sizes.

MINI TRUNKING

Mini trunking is an economical feeder trunking system with easy accessibility for wiring and re-wiring.

Product information

- A variety of sizes from 10 x 8mm to 38 x 38mm
- Self-fixing systems and punched systems available
- Punched holes compatible with Firefly fire safety clips*
- Self extinguishing and non-flame propagating PVC-U

Standard Colours		
WH	RD	BN
WH: White RD: Red BN: Brown		

Colour options: Red and Brown solid colour options are available as standard items for selected products. Please indicate when ordering by replacing the WH colour code suffix with either RD for red or BN for brown.

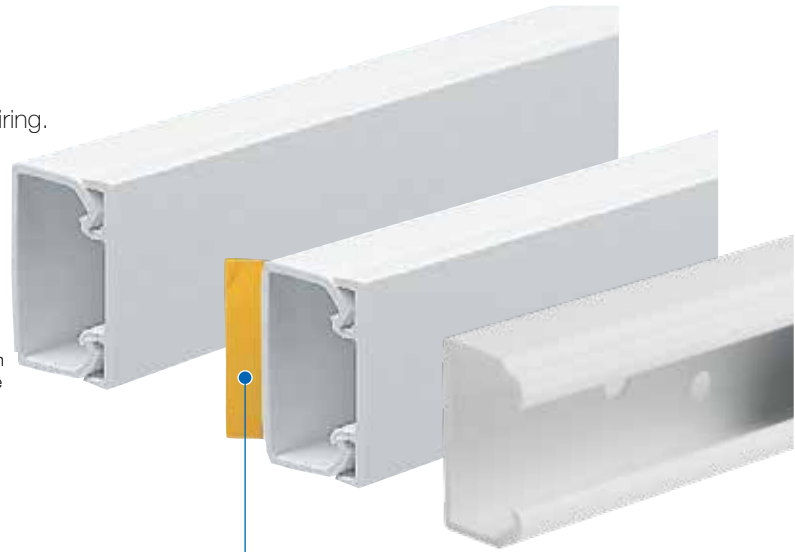

With or without self-fixing tape

See page 102 for quick reference chart

REASSURINGLY RECYCLED

OUR WHITE MINI TRUNKING LENGTHS ARE MANUFACTURED USING OVER 95% RECYCLED MATERIAL.

Standard profiles



MMT1		
code	size	pack
MMT1WH	16 x 16mm	30 x 3m



MMT2		
code	size	pack
MMT2WH	25 x 16mm	30 x 3m
Brown is available as standard colour		



MMT3		
code	size	pack
MMT3WH	38 x 16mm	15 x 3m
Red is available as standard colour		



MMT4		
code	size	pack
MMT4WH	38 x 25mm	15 x 3m
Brown is available as standard colour		



MMT5		
code	size	pack
MMT5WH	50 x 25mm	12 x 3m



MMT6		
code	size	pack
MMT6WH	38 x 38mm	6 x 3m

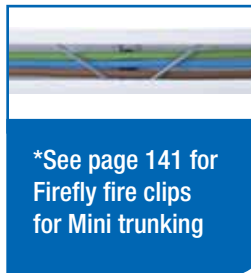

p254
Technical Information

Self fixing profiles



MMT00SF

code	size	pack
MMT00SFWH	10 x 8mm	40 x 3m

 Brown is available as standard colour



MMT0SF

code	size	pack
MMT0SFWH	16 x 10mm	40 x 3m



MMT1SF

code	size	pack
MMT1SFWH	16 x 16mm	30 x 3m



MMT2SF

code	size	pack
MMT2SFWH	25 x 16mm	30 x 3m

 Red and brown are available as standard colours



MMT3SF

code	size	pack
MMT3SFWH	38 x 16mm	15 x 3m



MMT4SF

code	size	pack
MMT4SFWH	38 x 25mm	15 x 3m

Punched profiles



Punched profiles MMTH2

code	size	pack
MMTH2WH	25 x 16mm	30 x 3m

 Red is available as a standard colour



Punched profiles MMTH2SF self fix

code	size	pack
MMTH2SFWH	25x16mm	30x3m



Punched profiles MMTH4

code	size	pack
MMTH4WH	38 x 25mm	15 x 3m



Punched profiles MMTH4SF self fix

code	size	pack
MMTH4SFWH	38x25mm	15x3m

Components



Ceiling rose adaptor

code	size	pack
TCR2WH	2 K.O. for MMT1	10
	2 K.O. for MMT2	

 Designed to accept all popular makes of ceiling rose. Supplied with fixing screws. Fixing centres 50.8mm. Internal depth 12mm. External diameter 81mm



Surface box adaptors MMT0/1/2/3

code	size	pack
TA1WH	MMT1	50
TA2WH	MMT2	50
TA3WH	MMT3	20

 TA0 fits MMT1-KO



Tapered adaptors MMT1 & 2 to fit TA3 aperture

code	size	pack
TA3/1CWH	MMT1	20
TA3/2LHWH	MMT2	20
TA3/2RHWH	MMT2	20
TA3/2CWH	MMT2	20



Conduit to mini adaptor

code	size	pack
TAC1/2WH	MMT1/20mm round	20

Accessories



PVC pipe cutter

code	pack
MTPC42	1

Please note

There are no fittings for MMT00SF and MMT0SFWH.

Coupler

External coupler

End cap

End cap

Internal bend

Square internal bend

External bend

Square external bend



MMT1WH, MMT1SFWH

16 x 16mm



TC1WH
Pack 40

TEC1WH
Pack 100

TIB1WH
Pack 50

TEB1WH
Pack 50

MMT2WH, MMT2SFWH, MMTH2WH, MMTH2SFWH

25 x 16mm



TC2WH*
Pack 40

TEC2WH*
Pack 100

TIB2WH*
Pack 30

TEB2WH*
Pack 30

MMT3WH, MMT3SFWH

38 x 16mm



TC3WH***
Pack 25

TEC3WH***
Pack 50

TIB3WH***
Pack 25

TEB3WH***
Pack 25

MMT4WH, MMT4SFWH, MMTH4WH, MMTH4SFWH

38 x 25mm



TC4WH**
Pack 25

TEC4WH**
Pack 30

TIB4WH**
Pack 25

TEB4WH**
Pack 25

MMT5WH

50 x 25mm



TC5WH
Pack 20

TEC5WH
Pack 20

TIB5WH
Pack 20

TEB5WH
Pack 20

MMT6WH

38 x 38mm



TC6WH
Pack 10

TEC6WH
Pack 20

TIB6WH
Pack 10

TEB6WH
Pack 10

Flat angles

Square angle

Tees

Square equal tee

Square unequal tee

Ceiling tee

Angle tee



MMT1WH, MMT1SFWH

16 x 16mm



TFB1WH
Pack 60

TT1-1WH
Pack 20

-

TCT1/1WH
Pack 10

-

MMT2WH, MMT2SFWH, MMTH2WH, MMTH2SFWH

25 x 16mm



TFB2WH*
Pack 30

TT2-2WH*
Pack 30

TT2-1WH
Pack 30

TCT2/1WH
TCT2/2WH
Pack 10

TAT2LHWH
TAT2RHWH
Pack 10

MMT3WH, MMT3SFWH

38 x 16mm



TFB3WH***
Pack 25

TT3-3WH***
Pack 25

TT3-1WH
TT3-2WH
Pack 20

-

-

MMT4WH, MMT4SFWH, MMTH4WH, MMTH4SFWH

38 x 25mm



TFB4WH**
Pack 20

TT4-4WH**
Pack 20

TT4-1WH
TT4-2WH
TT4-3WH
Pack 20

TCT4/2WH
Pack 10

-

MMT5WH

50 x 25mm



TFB5WH
Pack 20

TT5-5WH
Pack 20

-

-

-

MMT6WH

38 x 38mm



TFB6WH
Pack 10

TT6-6WH
Pack 10

-

-

-

* Red and brown are available as standard colours

** Brown is available as a standard colour

*** Red is available as a standard colour

1 gang accessory boxes - Square

Depth	Mini trunking sizes	Knockout entries	Code	Pack	
19mm	MMT1/2	LH, RH, Centre	MSSB28WH	20	
19mm	MMT3	LH, RH, Centre	MSSB110WH	20	
32mm	MMT1/2	LH, RH, Centre	MSSB35WH	20	
32mm	MMT3	LH, RH, Centre	MSSB116WH*	20	
44mm	MMT2/3	Centre entry for both MMT2 and MMT3. RH and LH side entry for MMT2.	MSSB18WH	10	
44mm	MMT3	LH, RH, Centre	MSSB120WH	10	

* MSSB116 is also available in red

1 gang accessory boxes - Radius

Depth	Mini trunking sizes	Knockout entries	Code	Pack	
19mm	MMT1/2	LH, RH, Centre	MSSB27WH	20	
19mm	MMT3	LH, RH, Centre	MSSB112WH	20	
32mm	MMT1/2	LH, RH, Centre	MSSB20WH	20	
32mm	MMT3	LH, RH, Centre	MSSB118WH	20	
44mm	MMT2/3	For MMT2 = 1 top entry centre For MMT3 = 1 bottom entry centre	MSSB42WH	10	
44mm	MMT3	LH, RH, Centre	MSSB122WH	10	

1 gang shrouded entry boxes – Square

Depth	Mini trunking sizes	Knockout entries	Code	Pack	
32mm	MMT2	With integral moulded MMT2 adaptor	MSSB15WH	20	

Cover plates

Depth	Mini trunking sizes	Description	Code	Pack	
2mm	N/A	Flat	MSCP2WH	20	
9mm	N/A	Raised	MSSP10WH	10	

Earth terminal

Size	Mini trunking sizes	Description	Code	Pack	
–	–	Brass earthing terminal – 15Amp rating	MET1	100	

p254

Technical
Information

2 gang boxes – Square

Depth	Mini trunking sizes	Knockout entries	Code	Pack
32mm	MMT2	LH, RH, Centre	MSSB36WH	10
32mm	MMT3	LH, RH, Centre	MSSB216WH	10
44mm	MMT2	Includes RH and LH side entry for MMT2	MSSB24WH	5
44mm	MMT3	LH, RH, Centre	MSSB220WH	5



2 gang boxes – Radius

Depth	Mini trunking sizes	Knockout entries	Code	Pack
32mm	MMT2	LH, RH, Centre	MSSB22WH	10
32mm	MMT3	LH, RH, Centre	MSSB218WH	10
44mm	MMT2/3	Centre entry	MSSB43WH	5
44mm	MMT3	LH, RH, Centre	MSSB222WH	5



2 x 1 gang box – Radius

Depth	Mini trunking sizes	Knockout entries	Code	Pack
32mm	MMT2	2 x 1 gang MMT2 centre and side entry	MSSB82WH	10



2 gang shrouded entry boxes – Square

Depth	Mini trunking sizes	Knockout entries	Code	Pack
32mm	MMT2	With integral moulded MMT2 adaptor	MSSB16WH	20
35mm	MMT2/3	Side entries permit horizontal and vertical accessory mounting Shrouded 2-part entry boxes for use with MMT2 and 3 (25 x 16mm and 38 x 16mm)	MSSB200WH	10



Cover plates

Depth	Mini trunking sizes	Description	Code	Pack
2mm	N/A	Flat	MSCP3WH	10
9mm	N/A	Raised	MSSP20WH	2



p254

Technical Information



**OUR WHITE MINI
TRUNKING LENGTHS
ARE MANUFACTURED
USING OVER 95%
RECYCLED MATERIAL**

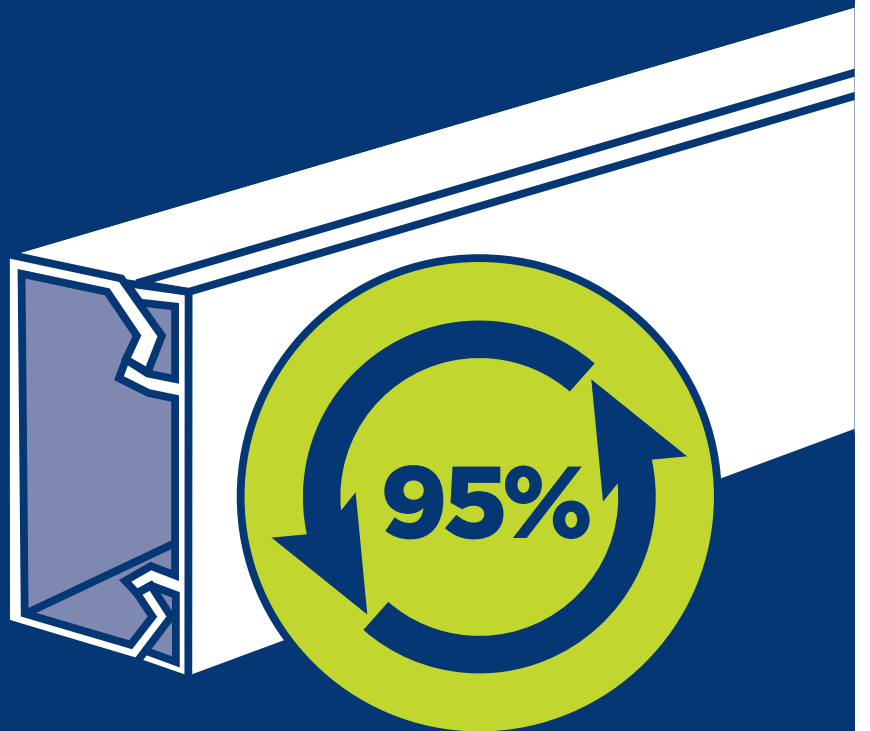

MAXI TRUNKING

A mid-size feeder and distribution trunking that can be subdivided to carry power and data. Larger sizes can also accommodate wiring accessories.

Product information

- A variety of sizes from 50 x 50mm to 150 x 150mm
- Single or divided compartment options
- Self extinguishing and non-flame propagating PVC-U

Data information

- Fabricated data slow bends

Standard Colour
WH
WH: White



See page 108 for quick reference chart

Single compartments are subdividable

REASSURINGLY RECYCLED OUR WHITE MAXI LENGTHS ARE MANUFACTURED USING OVER 94% RECYCLED MATERIAL.

Trunking profiles



MTRS50		
code	size	pack
MTRS50WH	50 x 50mm	8x3m



MTRS75/50		
code	size	pack
MTRS75/50WH	75 x 50mm	4x3m



MTRS75		
code	size	pack
MTRS75WH	75 x 75mm	4x3m



MTRS100/50		
code	size	pack
MTRS100/50WH	100x50mm	4x3m



MTRS100		
code	size	pack
MTRS100WH	100 x 100mm	4x3m



MTRS150		
code	size	pack
MTRS150WH	150 x 150mm	2x3m



See page 141 for Firefly fire clips for Maxi trunking

Clear Maxi trunking



Clear MTRS50		
code	size	pack
MTRS50CL	50x50mm	4x3m



Clear TCCS50 coupler		
code		pack
TCCS50CL		10

Clear maxi trunking is particularly useful for high security installations. Other clear Maxi products are available but are made to order and subject to set up charges. For further information please contact our technical team on +44 (0)1424 856688.

Fittings



Spacer – 25mm

code	pack
MTRS100LID25WH	20

For use between accessory boxes



Mini trunking adaptor

code	size	pack
TTA2WH	MMT2	10
TTA4WH	MMT4	10

Note: Only for minimum 50mm trunking depth



Flanged coupler

code	size	pack
TTRS1WH	MTRS100 to MTRS100/50	1
TTRS2WH	MTRS100 to MTRS75	1
TTRS3WH	MTRS100 to MTRS75/50	1
TTRS4WH	MTRS100 to MTRS50	1
TTRS5WH	MTRS100/50 to MTRS75/50	1
TTRS6WH	MTRS100/50 to MTRS50	1
TTRS7WH	MTRS75 to MTRS75/50	1
TTRS8WH	MTRS75 to MTRS50	1
TTRS9WH	MTRS75/50 to MTRS50	1
TTRS10WH	MTRS150 to MTRS100	1
TTRS11WH	MTRS150 to MTRS75	1

Clip on fittings

For individual components and part numbers please refer to fittings chart on next page.



Slow bend fittings for data

For individual components and part numbers please refer to fitting chart on next page.



Fabricated fittings

For individual components and part numbers please refer to fittings chart on next page.



Components



Dividing fillet

code	system	pack
MDFS50	50 x 50mm	10 x 3m
	75 x 50mm	
	100 x 50mm	
MDFS75	75 x 75mm	10 x 3m
MDFS100	100 x 100mm	10 x 3m
MDFS150	150 x 150mm	10 x 3m

Boxes and plates



1 gang accessory box

code	pack
TSS03WH	20

For MTRS100/50 and MTRS100.
Internal depth 30mm



2 gang accessory box

code	pack
TSS04WH	10

For MTRS100/50 and MTRS100.
Internal depth 30mm



1 gang accessory plate

code	pack
MTSPS1WH	15

For MTRS100/50 and MTRS100.















2 gang accessory plate

code	pack
MTSPS2WH	15











For MTRS100/50 and MTRS100.

p255

Technical Information

		Fittings					
		Dividing fillet	Cable retainer	External coupler	Internal coupler	Flanged coupler	End cap
							
MTRS50WH* 50 x 50mm		MDFS50 Pack 10 x 3m	TCRS50 Pack 10	TCCS50WH* Pack 10	TICS50WH Pack 10	TFCS50WH Pack 1	TECS50WH Pack 10
MTRS75/50WH 75 x 50mm		MDFS50 Pack 10 x 3m	TCRS75 Pack 10	TCCS75/50WH Pack 10	TICS75/50WH Pack 10	TFCS75/50WH Pack 1	TECS75/50WH Pack 10
MTRS75WH 75 x 75mm		MDFS75 Pack 10 x 3m	TCRS75 Pack 10	TCCS75WH Pack 10	TICS75WH Pack 5	TFCS75WH Pack 1	TECS75WH Pack 5
MTRS100/50WH 100 x 50mm		MDFS50 Pack 10 x 3m	TCRS100 Pack 10	TCCS100/50WH Pack 10	TICS100/50WH Pack 5	TFCS100/50WH Pack 1	TECS100/50WH Pack 5
MTRS100WH 100 x 100mm		MDFS100 Pack 10 x 3m	TCRS100 Pack 10	TCCS100WH Pack 2	TICS100WH Pack 5	TFCS100WH Pack 1	TECS100WH Pack 5
MTRS150WH 150 x 150mm		MDFS150 Pack 10 x 3m	TCRS150 Pack 5	-	TICS150WH Pack 5	-	TECS150WH Pack 1

*Clear is available as standard colour

		Flat angles				
		90° flat angle (clip-on)	90° flat angle (moulded)	90° flat angle (fabricated)	90° data flat angle (fabricated)	135° flat angle (fabricated)
						
MTRS50WH 50 x 50mm		TFAS50CWH Pack 1	TFAS50MWH Pack 1	TFAS50FWH Pack 1	TFAS50SBWH Pack 1	TFAS50ABWH Pack 1
MTRS75/50WH 75 x 50mm		-	TFAS75/50MWH Pack 1	TFAS75/50FWH Pack 1	-	-
MTRS75WH 75 x 75mm		-	TFAS75MWH Pack 1	TFAS75FWH Pack 1	-	-
MTRS100/50WH 100 x 50mm		TFAS100/50CWH Pack 1	-	TFAS100/50FWH Pack 1	-	-
MTRS100WH 100 x 100mm		-	-	TFAS100FWH Pack 1	-	-
MTRS150WH 150 x 150mm		-	-	TFAS150FWH Pack 1	-	-

Internal bends					External bends				
Internal 90° bend (clip-on)	Internal 90° bend (moulded)	Internal 90° bend (fabricated)	Internal 90° Data bend (fabricated)	Internal 135° Data bend (fabricated)	External 90° bend (clip-on)	External 90° bend (moulded)	External 90° bend (fabricated)	External 90° Data bend (clip-on)	External 135° bend (fabricated)
TIAS50CWH Pack 1	TIAS50MWH Pack 1	TIAS50FWH Pack 1	TIAS50SBWH Pack 1	TIAS50ABWH Pack 1	TOAS50CWH Pack 1	TOAS50MWH Pack 1	TOAS50FWH Pack 1	TOAS50SBWH Pack 1	TOAS50ABWH Pack 1
-	-	TIAS75/50WH Pack 1	-	-	-	-	TOAS75/50WH Pack 1	-	-
-	-	TIAS75WH Pack 1	-	-	-	-	TOAS75WH Pack 1	-	-
TIAS100/50CWH Pack 1	-	TIAS100/50WH Pack 1	-	-	TOAS100/50CWH Pack 1	-	TOAS100/50WH Pack 1	-	-
-	-	TIAS100WH Pack 1	-	-	-	-	TOAS100WH Pack 1	-	-
-	-	TIAS150WH Pack 1	-	-	-	-	TOAS150WH Pack 1	-	-

Tees					Crossovers
Flat tee (moulded)	Flat tee (fabricated)	Data flat tee (gusseted)	External edge tee (fabricated)	Internal edge tee (fabricated)	Flat crossover (fabricated)
-	TFTS50WH Pack 1	TFTS50GTWH Pack 1	TTES50WH Pack 1	TTIS50WH Pack 1	-
TFTS75/50MWH Pack 1	TFTS75/50WH Pack 1	-	TTES75/50WH Pack 1	TTIS75/50WH Pack 1	-
-	TFTS75WH Pack 1	-	TTES75WH Pack 1	TTIS75WH Pack 1	TCUS75WH Pack 1
-	TFTS100/50WH Pack 1	-	TTES100/50WH Pack 1	TTIS100/50WH Pack 1	TCUS100/50WH Pack 1
-	TFTS100WH Pack 1	-	TTES100WH Pack 1	TTIS100WH Pack 1	TCUS100WH Pack 1
-	TFTS150WH Pack 1	-	TTES150WH Pack 1	TTIS150WH Pack 1	-





OUR WHITE MAXI LENGTHS ARE MANUFACTURED USING OVER 94% RECYCLED MATERIAL.

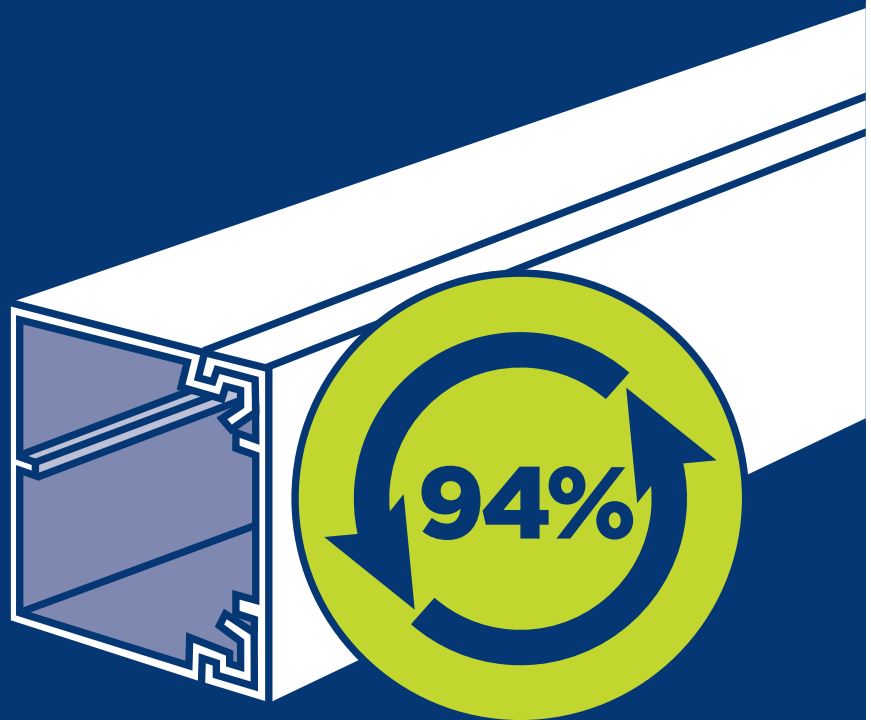

PVC-U TRUNKING

CORNICE TRUNKING

Cornice trunking provides elegant and unobtrusive concealment for surface wiring around ceilings.

Product information

- 50 x 50mm
- Designed for use with MMT2 mini trunking (see page 100)
- Adaptors available for cable runs across ceilings or down walls
- Built in cable retainer
- Use with mini trunking to supply pendant drops and surface accessories
- Removable cover
- Self extinguishing and non-flame propagating PVC-U

Standard Colour
WH
WH: White



Trunking profile



Cornice trunking

code	size	pack
MCT1WH	50 x 50	8 x 3m

Fittings



Coupler

code	pack
MCTC1WH	10



End cap

code	pack
MCEC1WH	10



Internal bend

code	pack
MCIB1WH	10



External bend

code	pack
MCEB1WH	10



Cable retainer

code	pack
MCBP1	10



Corner adaptor LH to Mini trunking

code	size	pack
MCCD2LHWH	MMT2	10



Corner adaptor RH to Mini trunking

code	size	pack
MCCD2RHWH	MMT2	10



Trunking adaptor to MMT2 Mini trunking

code	pack
MCTA2WH	10

PVC-U TRUNKING



SOVEREIGN PLUS TRUNKING

Sovereign Plus skirting trunking is a slim trunking system suitable for installation into hotels, small offices and residential properties.

Product information

- 75 x 20mm
- 3 compartments
- Suitable for skirting applications
- Overlapping fittings
- Accessory boxes designed to accept square and radius corner accessories
- Designed for use with MMT2 mini trunking (see page 100)
- Self extinguishing and non-flame propagating PVC-U

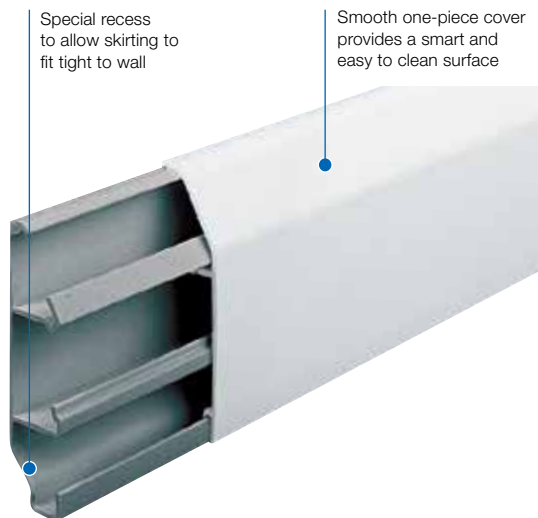

Standard Colour
WH
WH: White

Trunking profile



Skirting trunking

code	size	pack
JE03WH	75 x 20	8 x 3

Fittings



Coupler

code	size	pack
JM22WH		20



End cap

code	size	pack
JM21WH	(left hand)	5
JM20WH	(right hand)	5



Internal bend

code	size	pack
JM23WH		10



External bend

code	size	pack
JM24WH		10



MMT2 adaptor (in line)

code	size	pack
JM25WH	25 x 16	5

Boxes and plates



1 gang skirting accessory box

code	depth	pack
JM41WH	32mm	5



2 gang skirting accessory box

code	depth	pack
JM42WH	32mm	3

p258
Technical Information

SCEPTRE TRUNKING

Sceptre trunking is the smallest trunking system that can still accept a full range of standard wiring accessories. It is suitable for unobtrusive, multiple outlet, surface installations.

Product information

- 100 x 40mm
- Can be subdivided
- Segregated accessory boxes
- Self extinguishing and non-flame propagating PVC-U

Standard Colour
WH
WH: White



Can be subdivided to make 3 compartments

Trunking profiles



Sceptre DTR1

code	size	pack
DTR1WH	100 x 40mm	4 x 3m

Fittings



Coupler

code	size	pack
DCJ1WH	100 x 40mm	5



End cap

code	size	pack
DEC1WH	100 x 40mm	5



Internal bend

code	size	pack
DIB1WH	100 x 40mm	5



External bend

code	size	pack
DEB1WH	100 x 40mm	5



Flat angle

code	size	pack
DFB1WH	100 x 40mm	5



Flat tee (fabricated)

code	size	pack
DFT1WH	100 x 40mm	1

Components



Dividing fillets

code	size	pack
DDF1	40mm	10 x 3m



Cable retainer

code	size	pack
TCRS100	100mm	10

Assembly
The segregated accessory box has a 2 part assembly and an internal depth of 25mm.

Boxes and plates



1 gang accessory box

code	pack
TSS01WH	10



2 gang accessory box

code	pack
TSS02WH	5



1 gang accessory plate

code	pack
MTSPS1WH	15



2 gang accessory plate

code	pack
MTSPS2WH	15

PVC-U TRUNKING

Firefly

p141

FIREFLY FIRE SAFETY CLIPS: SAVING LIVES IN THE EVENT OF A FIRE

firefly[™]
FIXINGS
from Marshall-Tufflex

To comply with BS 7671:2018 IET Wiring Regulations, Marshall-Tufflex supply a range of Firefly fire clips to secure cables internally or externally of trunking or conduit. The clips are designed to secure all surface cables throughout an installation.



- Fire safety clips to comply with BS 5839-1
- For use within trunking and conduit
- Spring loaded design for easy installation or removal of cables
- Designed for quick installation and to maximise internal trunking space
- Internal version to fit within trunking prior to cables being installed
- External version to retrofit onto existing installations
- Melt point over 1000°C
- Kits available including all required fixings/screws ready for installation



Regulations

Regulations state that wiring systems shall be supported such that they will not be liable to premature collapse in the event of a fire.

Firefly clips meet the requirements of the current version of BS 7671 Wiring Regulations to secure surface cables and to avoid the risk of entanglement in the event of a fire.

Firefly clips feature rounded ends, preventing damage to cables and injury to installers. The spring-loaded design makes it straightforward to install and to add or remove cables after the initial installation.

BS 7671:2018 IET Wiring Regulations

See chapter 52 Selection and Erection of Wiring Systems 521.10.202 of the IET Wiring Regulations

See page 141 for product ordering information.

BENCH TRUNKING



Bench trunking is a robust angled trunking that can be mounted directly on to desks, work benches or fitted under shelving.

Product information

- 105 x 105mm
- Suitable for desk, bench or worktop applications
- Can be subdivided
- Fully compatible with Marshall-Tufflex and UK standard power and data accessories
- Adjustable data box 32-47mm
- Compliant up to Cat 7a
- Self extinguishing PVC-U



Single or double-sided configuration - for double sided versions, use two single-sided trunking assemblies back-to-back and couple using double-sided end caps

Can be subdivided

Standard Colour
WH
WH: White

Trunking profile



Trunking assembly

code	size	pack
MBT105WH	105 x 105mm	2 x 3m

Part M

For box assemblies that meet the requirements of Part M (DDA) please refer to page 54.

Fittings



Coupler

code	pack
BTC105WH	1



Single sided end caps

code	pack
BEC105WH	2

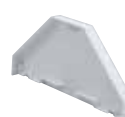

Double sided end caps

code	pack
BECP210WH	2



Internal bend

code	pack
BIA105WH	1

Couplers required with bends

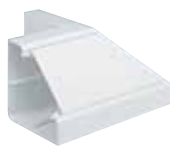

External bend

code	pack
BEA105WH	1

Couplers required with bends

Components



Dividing fillet

code	pack
BDF105WH	4 x 3m

PVC-U TRUNKING

p259 Technical Information

Bench units



1 gang single sided unit
code pack
MBU1WH 1



1 gang double sided unit
code pack
MDBU1WH 1



2 gang single sided unit
code pack
MBU2WH 1



2 gang double sided unit
code pack
MDBU2WH 1



1 plus 2 gang single sided unit
code pack
MBU3WH 1



1 plus 2 gang double sided unit
code pack
MDBU3WH 1

PVC-U TRUNKING

Boxes and plates



***RCD/MCB housing**
code pack
BAHC1MWH 1

*Up to 4 modules can be accommodated
Note: RCDs and MCBs are not supplied by Marshall-Tufflex



1 gang accessory box
code depth pack
ESSB1WH 30mm 20



2 gang accessory box
code depth pack
ESSB2WH 30mm 10

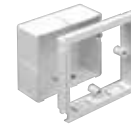

1 gang adjustable depth box
code depth pack
EAB1WH 32 – 47mm 10

Please see page 123 for more information on the range of adjustable boxes



2 gang adjustable depth box
code depth pack
EAB2WH 32 – 47mm 5

Please see page 123 for more information on the range of adjustable boxes



1 gang accessory plate
code pack
ESSP1WH 2



2 gang accessory plate
code pack
ESSP2WH 2



13Amp DP 1 gang switched socket
code pack
ESS1WH 1



13Amp DP 2 gang switched socket Twin earth
code pack
ESS2WH 1