

**Double Roman**  
Code: GTV-DR

*For use with:*

Marley Double Roman  
Redland Double Roman  
Sandtoft Double Roman  
Russell Double Roman  
Lagan Double Roll

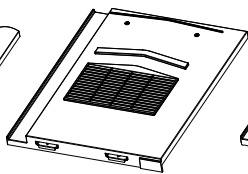

**Non-Profile**  
Code: GTV-NP

*For use with:*

Marley Modern  
Redland Mini Stonewold  
Sandtoft Caderdale  
Russell Grampian  
Lagan Flat

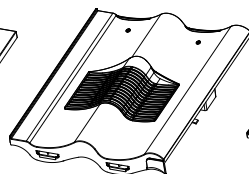

**Double Pantile**  
Code: GTV-DP

*For use with:*

Marley Mendip  
Redland Grovebury  
Sandtoft Double Pantile  
Russell Pennine

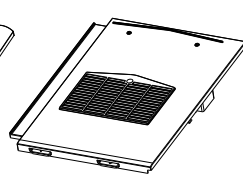

**Thin Leading Edge**  
Code: GTV-TE

*For use with:*

Marley Edgemere  
Redland Richmond  
Sandtoft TLE  
Russell Galloway  
Lagan Elite

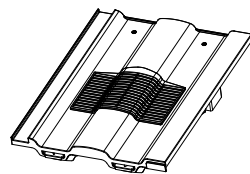

**Castellated**  
Code: GTV-CS

*For use with:*

Marley Ludlow Major  
Redland Renown  
Sandtoft Lindum  
Russell Cheviot  
Lagan Square Top

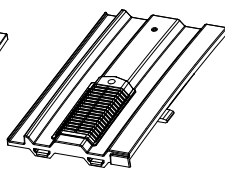

**Mini Castellated**  
Code: GTV-MC

*For use with:*

Marley Ludlow Plus  
Redland 49  
Sandtoft Standard attern  
Forticrete V2

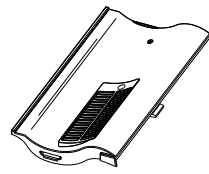

**Single Pantile**  
Code: GTV-SP

*For use with:*

Marley Anglia  
Redland Fenland  
Sandtoft Shire

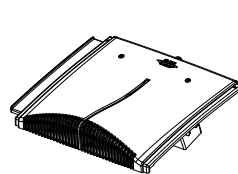

**Interlocking Plain Tile**  
Code: GTV-IP

*For use with:*

Marley Ashmore  
Redland DuoPlain  
Forticrete Gemini

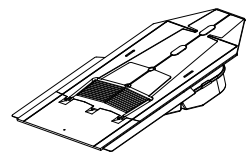

**Slate Vent (In-Line)**  
Code: GILSV30-25

*For use with:*

Man-made and natural slates.  
600 x 300mm up to 450mm in size.

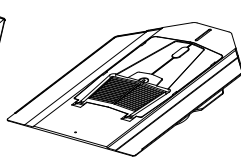

**Slate Vent (In-Line)**  
Code: GILSV25-20

*For use with:*

Man-made and natural slates.  
400 x 200mm up to 450 x 250mm.

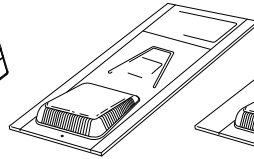

**Slate Vent (Hooded)**  
Code: GRSV30-25

*For use with:*

Man-made and natural slates.  
500 x 250mm up to 600 x 300mm.

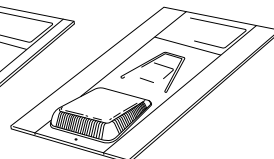

**Slate Vent (Hooded)**  
Code: GRSV45

*For use with:*

Man-made and natural slates.  
500 x 250mm up to 600 x 450mm.



## Tile Ventilator Range

# Plain Tile Ventilator

Fitting Instructions

MBP-0968-00-C

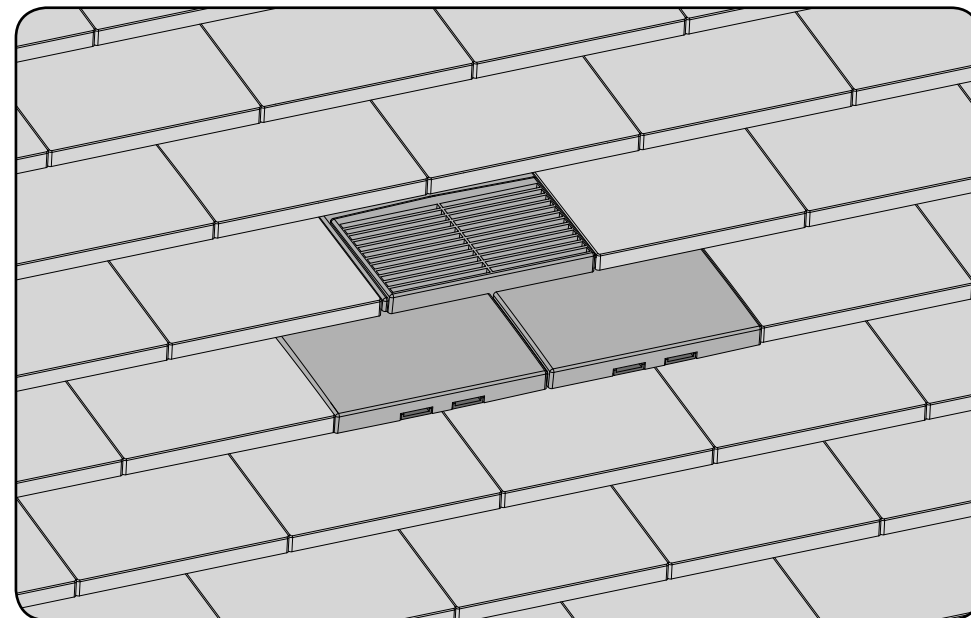

### Manthorpe Building Products Limited

Manthorpe House, Brittain Drive, Codnor Gate Business Park, Ripley, Derbyshire DE5 3ND  
T: (01773) 514200 F: (01773) 514262 E: bpsales@manthorpe.co.uk  
W: www.manthorpe.co.uk



## Plain Tile Ventilator Installation Requirements:

- Minimum Roof Pitch: 35°
- Minimum Batten Gauge: 88 mm (when used with 38mm roofing battens)
- Product Airflow: 7,000 mm<sup>2</sup>

The tile vent should not be used to extract hot exhaust gases, nor be placed close to other potentially hot elements of the roof structure.

When ventilating at high level, the vent should not be placed on the course directly below the ridge tile.

For mechanical extraction, use the Manthorpe **GTV-AD Flexi Pipe Adaptor** and one of the **GRPA Flexible Pipe Range** in conjunction with the vent.

## Installation

1. Prepare the tiles in the conventional manner up to the point where the tile ventilator is to be positioned.

2. Directly above the batten that the vent is to be placed on, mark out a rectangle on the underlay in line with the middle of the tile below, with an X in the centre.

The rectangle should be 240mm wide (A) and the full width of the space between the battens at that gauge (B).

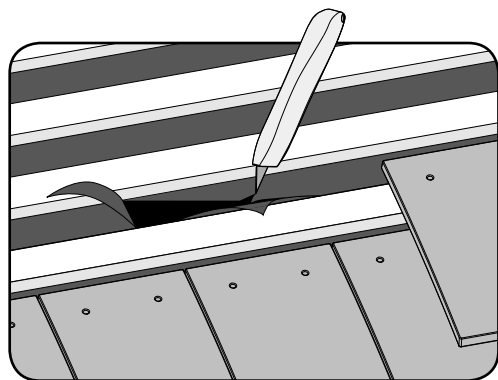

3. Cut the underlay along the diagonal X lines and fold back the triangular tabs to reveal the spigot opening.

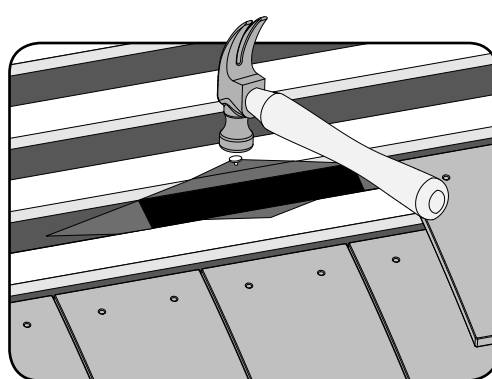
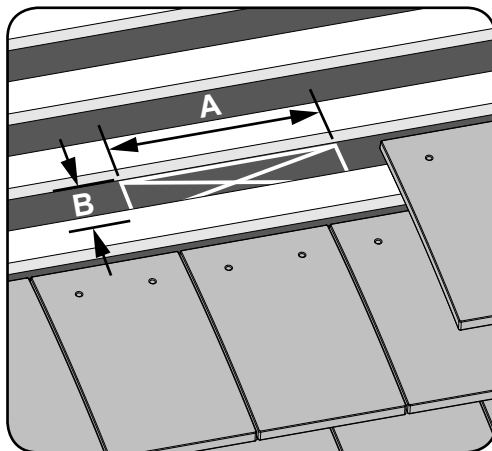

4. Fold the top tab tight up against the batten above it and secure it in position with a staple or tack.

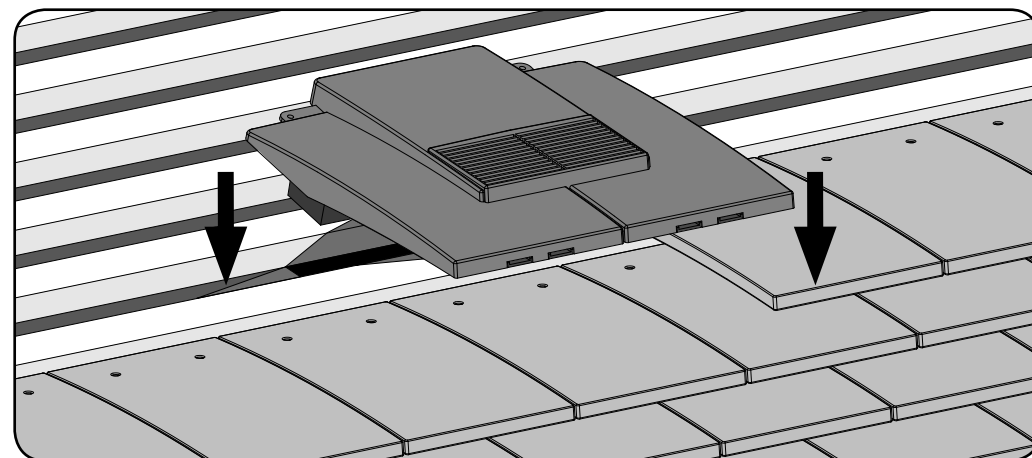

5. Slot the vent into the position. Make sure the spigot passes fully through the felt so it is accessible from the loft space. On roofs with smaller batten gauges it may be necessary to flex in the spigot clip to allow it to pass through the opening. Slide the vent left or right to align it with the adjacent tiles.

6. Once aligned, nail the vent down into position through the fixing holes provided. After the ventilator is secured in place, continue tiling in the normal manner, tile up to and around the grill opening on the courses above. It is recommended that all adjacent tiles surrounding the vent be nailed down.

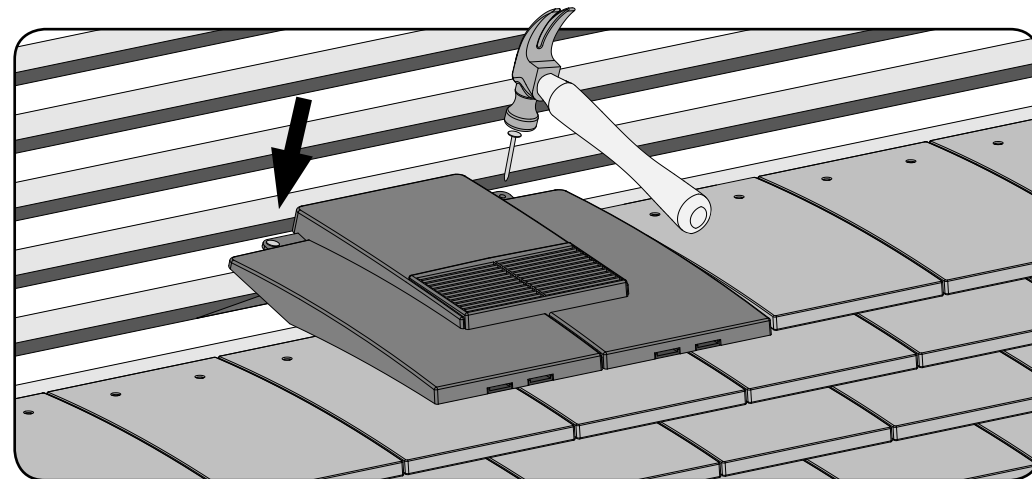

7. If you wish to use the terminal for mechanical extraction or soil stack ventilation, first install the vent then locate the outlet within the loft space. Align the rectangular opening of the GTV-AD with the outlet of the tile vent and firmly push it over, ensuring the clip feature slots inside. Push the adaptor until it reaches the stops on the vent's base moulding, at this point the clip should locate itself over the internal ledge of the GTV-AD to lock it in position. A GRPA or other flexible piping can then be fitted.

**NOTE:** To comply with the BRE Report 262, it is recommended that the GRPA pipes and other ducting should be fully insulated along its total length in the roof space to avoid the risk of internal condensation.