

TECHNOLOGY IN MOTION



# MACO PROTECT

DOOR LOCKS



Catalogue 2017



<b>N<sup>o</sup></b>	Part number		Cylinder dimension
	Packing unit		Door leaf width
	Handle centre (HC)		Surface finish
	Backset (BS)		Finger operated door shootbolt length
	Spindle size		Sash rebate width (SRW), standard
	Handle height (HH)	G-TS =	Handle operated door lock
	Sash rebate height (SRH)	Z-TS =	Cylinder operated door lock
	Faceplate width	Z-TF =	Triple Latch Door Lock
<b>L</b>	Overall component length	Z-TA =	Automatic Door Lock Triple Latch Lock
	Number of security cams (i.S.)	Z-RS =	Cylinder operated mortise lock
	Number of standard cams	MF =	Multifunctional latch
<b>W</b>	Width	ZS =	Additional lock
<b>H</b>	Height	B-TV =	Balcony door lock
	Right-angled latch plate dimensions	MM =	Multi-Matic
	Frontal faceplate height	U =	U-faceplate
	Back faceplate height	PZ	Profile cylinder (PC)
	Cutting measure	RZ	Round cylinder (RC)
	Radius	i.S. =	Security Cam
	Shootbolt throw	VZ =	Standard cam
	Shootbolt width	HO =	Hook (protruding upwards)
	Profile depth	BO =	Bolt
		HO-BO =	Hook & bolt combination
		MF-BO =	Multifunctional latch & bolt combination
		MF-HO =	Multifunctional latch & hook combination
		SFG =	French casement drive gear
		EV =	End piece
		K+ =	Case position above handle height



Dear MACO customer,

You are holding our new order catalogue in your hands. Our main aim was to present our product range in a simple and easy-to-understand manner in order to provide you with a practical working document. In addition to this catalogue, our package leaflet and assembly instructions will help you to process and install our products correctly. These are available to download from [www.maco.eu](http://www.maco.eu).

Our products help to ensure that windows, doors and large-scale elements offer optimum function and security. As a premium manufacturer, that carries out its business according to the highest standards, the optimum quality and functionality of our hardware is our top priority. While we guarantee the best possible product characteristics for our hardware components, the responsibility for professional installation and correct fixing lies in your hands.

We want to support you, as a dealer or fabricator, with your responsibility for the safety of your products. Our binding assembly instructions and package leaflets provide information about the general use and processing of our hardware. To ensure the best fabrication and attachment of the hardware components – to suit the relevant installation situation, such as strength and profile design of the timber, arrangement of chambers and reinforcement in PVC profiles, etc. , you can have elements tested and evaluated at our certified test centre: an air permeability and driving rain test as well as a pull-out test will help you to meet CE marking requirements. This means that you can rest assured that you are meeting all the standards and directives applicable to you.

You can find information about how to properly store our hardware components in the VHBH guideline of the Quality Assurance Association: Locks and Hardware ([www.fvsb.de](http://www.fvsb.de)) or section Information on storage and transport of hardware components.

**Important for dealers: MACO supplies its products with the corresponding number of package leaflets. As a dealer, you are responsible for enclosing the correct number of package leaflets with the products sold by you. Also, please ensure that you make your customers aware of the relevant binding instructions and legal aspects of the document.**

We also provide you with operation and maintenance instructions for end users for you to pass on to your customers. These can also be downloaded from the MACO website ([www.maco.eu](http://www.maco.eu)).

We are offering an option in our extranet ([extranet.maco.eu](http://extranet.maco.eu)) with our online catalogue, which, in addition to highly up-to-date information, also offers the advantage of extensive additional technical information for all components. You can obtain access details from your contact partner in field sales.

All of our printed documentation is continuously revised and expanded. Please make sure that you are working with our most current documentation. All of our documentation is available for download from [www.maco.eu](http://www.maco.eu). We hope that the catalogue will prove to be a valuable tool for your daily work. We wish you every success and hope to see you online soon.

*Please fill in completely*

<b>We confirm receipt and approvingly acknowledge its contents.</b>	
Stamp:          	<hr style="border: 0; border-top: 1px solid black; margin-bottom: 5px;"/> <p style="text-align: center;"><i>Please print your name in capital letters</i></p>
Date: _____	Signature: _____

MACO sales manager: \_\_\_\_\_

**MACO  
PROTECT**





<b>1</b>	<b>Technical and general information</b>	<b>1</b>	<b>7</b>
<b>2</b>	<b>Z-TA – Automatic Door Lock Triple Latch</b>	<b>2</b>	<b>13</b>
<b>3</b>	<b>Z-TF Triple Latch Door Lock</b>	<b>3</b>	<b>33</b>
<b>4</b>	<b>Z-TS Cylinder Operated Door Lock</b>	<b>4</b>	<b>71</b>
<b>5</b>	<b>G-TS Lever operated Door Lock</b>	<b>5</b>	<b>111</b>
<b>6</b>	<b>G-TA Lever Operated Automatic Door Lock</b>	<b>6</b>	<b>135</b>
<b>7</b>	<b>C-TS Combined Lever and Split Spindle Door Lock</b>	<b>7</b>	<b>137</b>
<b>8</b>	<b>Z-RS - Mortise Door Lock</b>	<b>8</b>	<b>145</b>
<b>9</b>	<b>B-TV - Balcony Door Lock</b>	<b>9</b>	<b>149</b>
<b>10</b>	<b>Striker plates</b>	<b>10</b>	<b>153</b>
<b>11</b>	<b>French casement drive gear</b>	<b>11</b>	<b>181</b>
<b>12</b>	<b>Shootbolts</b>	<b>12</b>	<b>187</b>
<b>13</b>	<b>openLife</b>	<b>13</b>	<b>191</b>
<b>14</b>	<b>Accessories</b>	<b>14</b>	<b>197</b>
<b>15</b>	<b>Jigs</b>	<b>15</b>	<b>215</b>
<b>16</b>	<b>Directory</b>		

**MACO  
PROTECT**





## 1 Technical and general information

---

1.1	How to use the catalogue	8
1.2	Innovative MACO top-hat faceplate solution	9
1.3	Product liability information	11
1.4	Storage instructions fittings	12
1.5	Certificates and guarantees	12
1.6	General Terms and Conditions	12



## 1 Technical and general information

### 1.1 How to use the catalogue

If not otherwise specified, all dimensions are stated in millimetres and packing units in items per box.

Drawings and diagrams are not to scale.

The content of this document is constantly being updated, so regular calibration is necessary.

The current version is downloadable from our website ([www.macouk.net](http://www.macouk.net)).

Please send comments or suggestions about our instructions by email to [feedback@maco.eu](mailto:feedback@maco.eu).

## 1.2 Innovative MACO top-hat faceplate solution

### Innovative MACO top hat faceplate solution

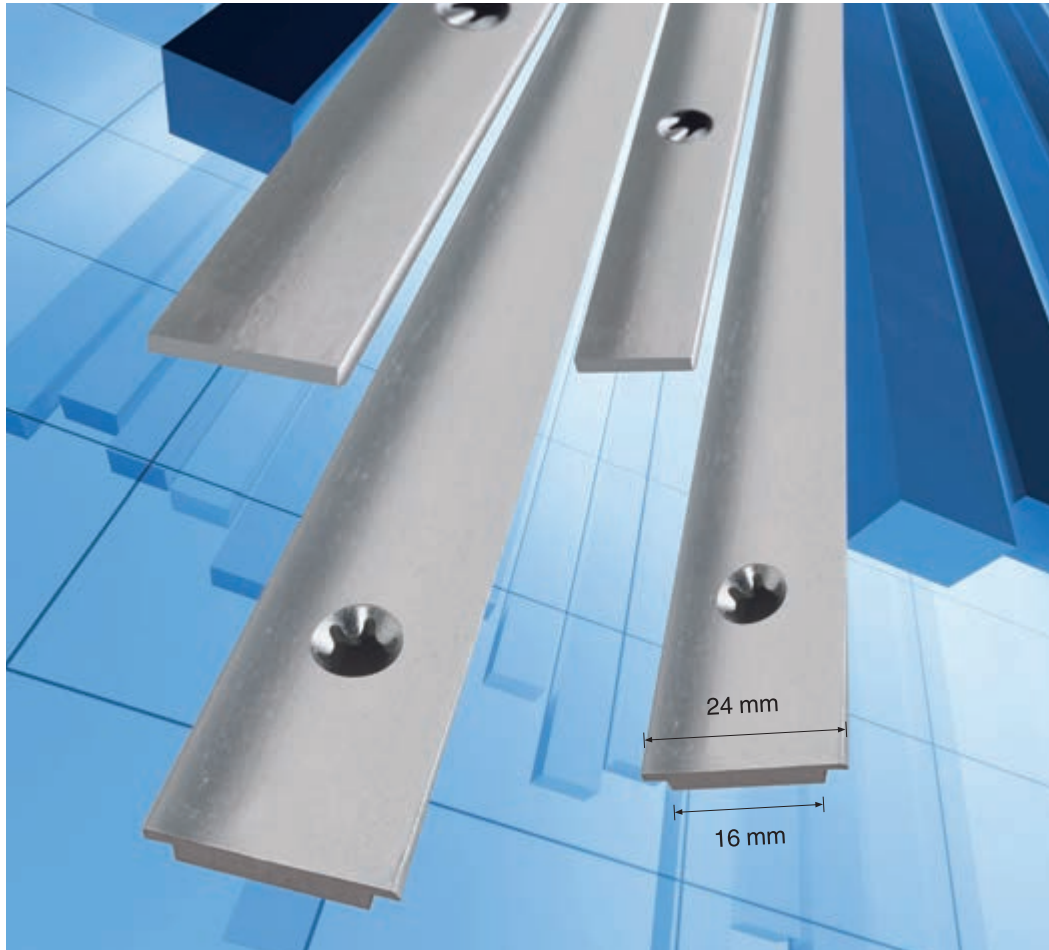

#### The faceplate technology evolution

##### Advantages

- Security and aesthetics of the 24 mm flat faceplate also in conjunction with a 16 mm fitting groove
- Stops dirt deposits between the faceplate and the fitting groove
- Protruding lock routings are safely covered
- No reduction of the door clearance as is the case when using for example a 24 x 3 mm flat faceplate
- Suitable for use with all PROTECT i.S. striker plates
- Higher stability than with the 16 x 3 mm flat faceplate
- Straightforward installation, and the same screw positions as on the standard faceplate

### Top hat faceplate advantages (F-24/16x3 mm)

Stops dirt deposits between the faceplate and the fitting groove



Protruding lock routings are safely covered

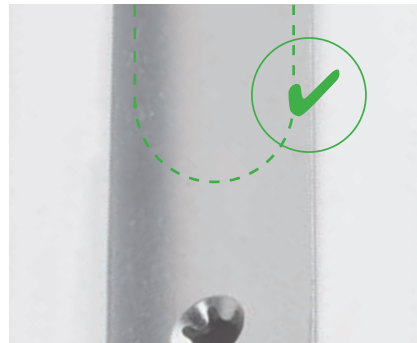

No reduction in the working air-gap as there would be with a 24 x 3 mm flat faceplate

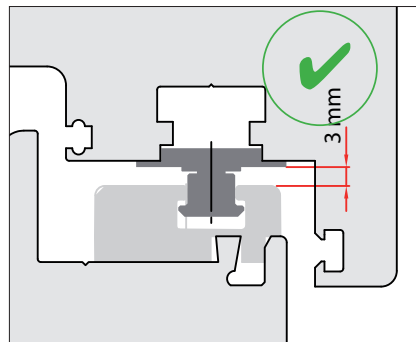
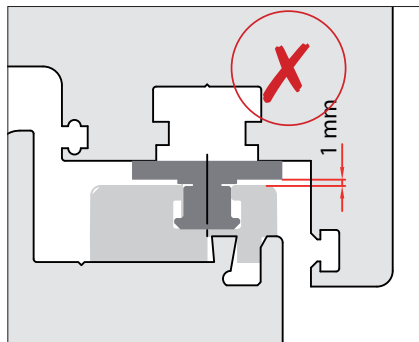



## 1.3 Product liability information

### "PROTECT" Door Locks

In accordance with the manufacturer's liability for his products, which is defined in the "Product Liability Law" (§ 1 PHG), the following information is binding and should be considered for the entire "Protect" door lock product range. Non-compliance shall relieve the manufacturer of all liability.

#### 1.3.1 Product information and conventional use

In terms of this definition, the door lock product range includes (door leaf and frame) fittings for timber, PVCu and aluminium doors and their corresponding material combinations. The functions of the door locks fundamentally consist of

- a) closing doors (keeping the door closed via latches) and
- b) locking the door (securing the door via additional locking elements).

Every MACO door lock is offered as a multipoint lock and is used for locking systems for vertically fitted doors. The MACO door lock product range offers two door lock systems that differ in their functionality:

##### 1.3.1.1 Door lock with handle actuation (G-TS)

When closing and locking the G-TS, the locking elements are extended by actuating the handle upwards. After securing the door, the door lock is activated by turning the key through 360°. The handle can no longer be depressed; the locking elements are locked in place. The G-TS can be unlocked again by turning the key in the cylinder lock anti-clockwise through one rotation; the locking elements are no longer locked in place. By pressing the handle downwards, the locking elements are retracted at the same time as the latch and the door is therefore open again.

Important: Door handles must be fitted to the door interior and exterior for a handle actuated door lock!

##### 1.3.1.2 Door lock with cylinder actuation (Z-TS / Z-TF)

After closing the door, the Z-TS / Z-TF is locked by turning the key in the profile cylinder through two 360° rotations. When doing this, the locking elements are extended into the striker plates and the door is locked. The Z-TS / Z-TF can be unlocked by turning the key through two anti-clockwise rotations; the latch can be retracted by actuating the handle and by turning the key in the profile cylinder.

A knob can be fitted to the door exterior for door locks with cylinder actuation.

The MACO multipoint locks are intended for combination with commercial profile cylinders according to DIN 18252 / EN 1303. The lock cases correspond to DIN 18251. In special cases the fitter of MACO door lock systems must ensure that the cylinder lock selected is suitable for the intended installation and that its functionality is guaranteed for the intended application.

### 1.3.2 Product installation

The MACO multipoint locks should only be fitted by specialists. The MACO door locks must be able to be inserted easily into the recesses provided in the fitting groove for lock cases, hook locks and finger bolt locks. Any component forced into the recesses can impair the functionality of the entire door lock system.

The lock faceplate must be screwed into the eurogroove using appropriate tools (torque function!). The striker plates (standard striker plates, EH Security-striker plates, hook and finger bolt striker plates) must be fitted in such a way that they allow the locking elements to be retracted unhindered and that even fully extended locking elements are not able to protrude as far as the stop in the striker plate.

To ensure the correct installation of the components, notches are punched on the lock cover and on the respective striker plate, which designate the optimal position of the striker plate to the door lock cover.

The MACO multipoint locks can be fitted to many types of house or side entrance doors. It should be noted that these components are not suitable to accommodate alterations in shape or alterations of the seal closure as a result of variations in temperature or building alterations.

### 1.3.3 Non-intended use and incorrect use

Please refer to the instruction manual for, among other things, incorrect use and non-intended use.

### 1.3.4 Product maintenance and information duty

In order to ensure perfect functionality of the MACO multipoint locks:

the necessary information and instructions are to be transferred to the appropriate persons;

the applicable standards are to be observed;

MACO multipoint locks must be used according to their defined function;

the manufacturer's regulations concerning the configuration of the hardware is to be observed;

maintenance and care instructions are to be followed;

faults may only be repaired by specialist personnel.

### 1.3.5 Product performance

Unless the product performances are explicitly specified in our catalogues and brochures, the requirements of the individual locking systems must be agreed with us. The information concerning product performance solely refers to the combination of MACO original parts. The efficiency of locking systems depends on, among other things, frequency of use, method of operation, environmental influences, maintenance and care.



## 1.4 Storage instructions fittings

Improper storage of fittings can affect the surface quality. To prevent this, the following points should be noted:

- Ensure that the room air is permanently dry
- Large temperature fluctuations, which lead to condensation must be prevented. Condensation on fittings means that the galvanized surfaces are attacked
- Aggressive vapors by cleaners or assembly aids such as silicone, and the like must - be avoided - even briefly. Vapors of such substances can cause very rapid corrosion of fittings
- Salty air or polluted by industrial air causes galvanized surfaces to corrode and can leave deposits.

## 1.5 Certificates and guarantees

MACO ensures high quality, not only with ongoing continuous internal testing, but also through external auditing by renowned, independent institutes. Copies of all our independent test certificates, covering our quality, safety and environmental management systems, as well as our product guarantees are

available to download from our website [www.maco.eu](http://www.maco.eu). In addition our safety descriptions relating to dangerous substances (REACH Declaration) are available, covering all MACO products.

## 1.6 General Terms and Conditions

Our general terms and conditions are available for download from our website ([www.maco.eu](http://www.maco.eu)).



## **2 Z-TA – Automatic Door Lock Triple Latch**

---

<b>2.1</b>	<b>Hardware overview Z-TA automatic</b>	<b>14</b>
<b>2.2</b>	<b>Door lock Z-TA with 2 MF-HO</b>	<b>19</b>
2.2.1	Door lock Z-TA Automatic PT-M with 2 MF-HO E92 F-16	19
2.2.2	Door lock Varia Z-TA Automatic PT-M with 2 MF-HO E92 F-16 HH1460	19
2.2.3	Door lock Z-TA Automatic PT-M with 2 MF-HO E92 F-16 K+605	19
2.2.4	Door lock Z-TA Automatic PT-M with 2 MF-HO E92 F-16 K+980	20
2.2.5	Door lock Z-TA Automatic PT-M with 2 MF-HO E92 F-20	20
2.2.6	Door lock Z-TA Automatic PT-M with 2 MF-HO E92 F-20 K+605	21
2.2.7	Door lock Z-TA Automatic PT-M with 2 MF-HO E92 F-20 K+980	21
2.2.8	Door lock Z-TA Automatic PT-M with 2 MF-HO E92 R20 HH 890	22
2.2.9	Door lock Varia Z-TA Automatic PT-M with 2 MF-HO E92 R20 HH890	22
2.2.10	Door lock Varia Z-TA Automatic PT-M with 2 MF-HO E92 R20 HH1300	22
2.2.11	Door lock Z-TA Automatic PT-M with 2 MF-HO E92 F-24	22
2.2.12	Door lock Z-TA Automatic PT-M with 2 MF-HO E92 F-24 K+605	23
2.2.13	Door lock Z-TA Automatic PT-M with 2 MF-HO E92 F-24 K+980	23
2.2.14	Door lock Z-TA Automatic PT-M with 2 MF-HO E92 F-24/16 top-hat faceplate	24
2.2.15	Door lock Z-TA Automatic PT-M with 2 MF-HO E92 F-24/16 K+605	24
2.2.16	Door lock Z-TA Automatic PT-M with 2 MF-HO E92 F-24/16 K+980	25
2.2.17	Door lock Z-TA Automatic PT-M with 2 MF-HO E92 U-6x24x6	25
2.2.18	Door lock Z-TA Automatic PT-M with 2 MF-HO E92 U-6x24x6 HH885	25
2.2.19	Door lock Z-TA Automatic PT-M with 2 MF-HO E92 U-6x24x6 K+605	26
2.2.20	Door lock Z-TA Automatic PT-M with 2 MF-HO E92 U-6x24x6 K+605 HH885	26
2.2.21	Door lock Z-TA Automatic PT-M with 2 MF-HO E92 U-6x24x6 K+980	26
2.2.22	Door lock Z-TA Automatic PT-M with 2 MF-HO E92 U-6x24x6 K+980 HH885	27
2.2.23	Door lock Z-TA Automatic PT-M with 2 MF-HO E94 F-16	27
2.2.24	Door lock Z-TA Automatic PT-M with 2 MF-HO E94 F-16 K+605	27
2.2.25	Door lock Z-TA Automatic PT-M with 2 MF-HO E94 F-16 K+980	28
2.2.26	Door lock Z-TA Automatic PT-M with 2 MF-HO E94 F-20	28
2.2.27	Door lock Z-TA Automatic PT-M with 2 MF-HO E94 F-20 K+605	28
2.2.28	Door lock Z-TA Automatic PT-M with 2 MF-HO E94 F-20 K+980	29
2.2.29	Door lock Z-TA Automatic PT-M with 2 MF-HO E94 F-24	29
2.2.30	Door lock Z-TA Automatic PT-M with 2 MF-HO E94 F-24 K+605	29
2.2.31	Door lock Z-TA Automatic PT-M with 2 MF-HO E94 F-24 K+980	30
2.2.32	Door lock Z-TA Automatic PT-M with 2 MF-HO E94 F-24/16 top-hat faceplate	30
2.2.33	Door lock Z-TA Automatic PT-M with 2 MF-HO E94 F-24/16 K+605	30
2.2.34	Door lock Z-TA Automatic PT-M with 2 MF-HO E94 F-24/16 K+980	31
2.2.35	Door lock Z-TA Automatic PT-M with 2 MF-HO E94 U-6x24x6	31
2.2.36	Door lock Z-TA Automatic PT-M with 2 MF-HO E94 U-6x24x6 K+605	31
2.2.37	Door lock Z-TA Automatic PT-M with 2 MF-HO E94 U-6x24x6 K+980	31

## 2 Z-TA – Automatic Door Lock Triple Latch

### 2.1 Hardware overview Z-TA automatic

① shortening faceplate

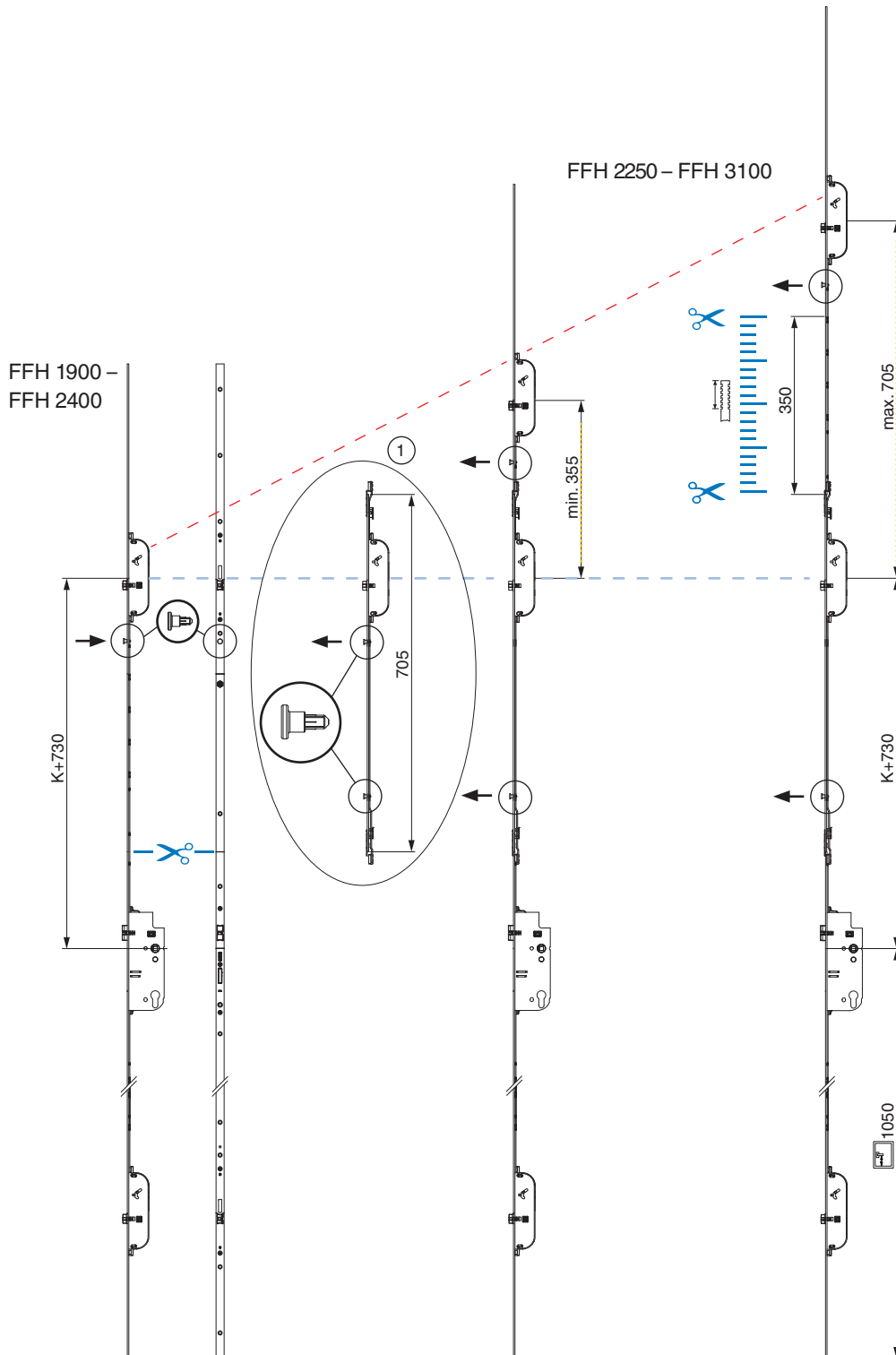

- ① shortening faceplate
- ② extension faceplate

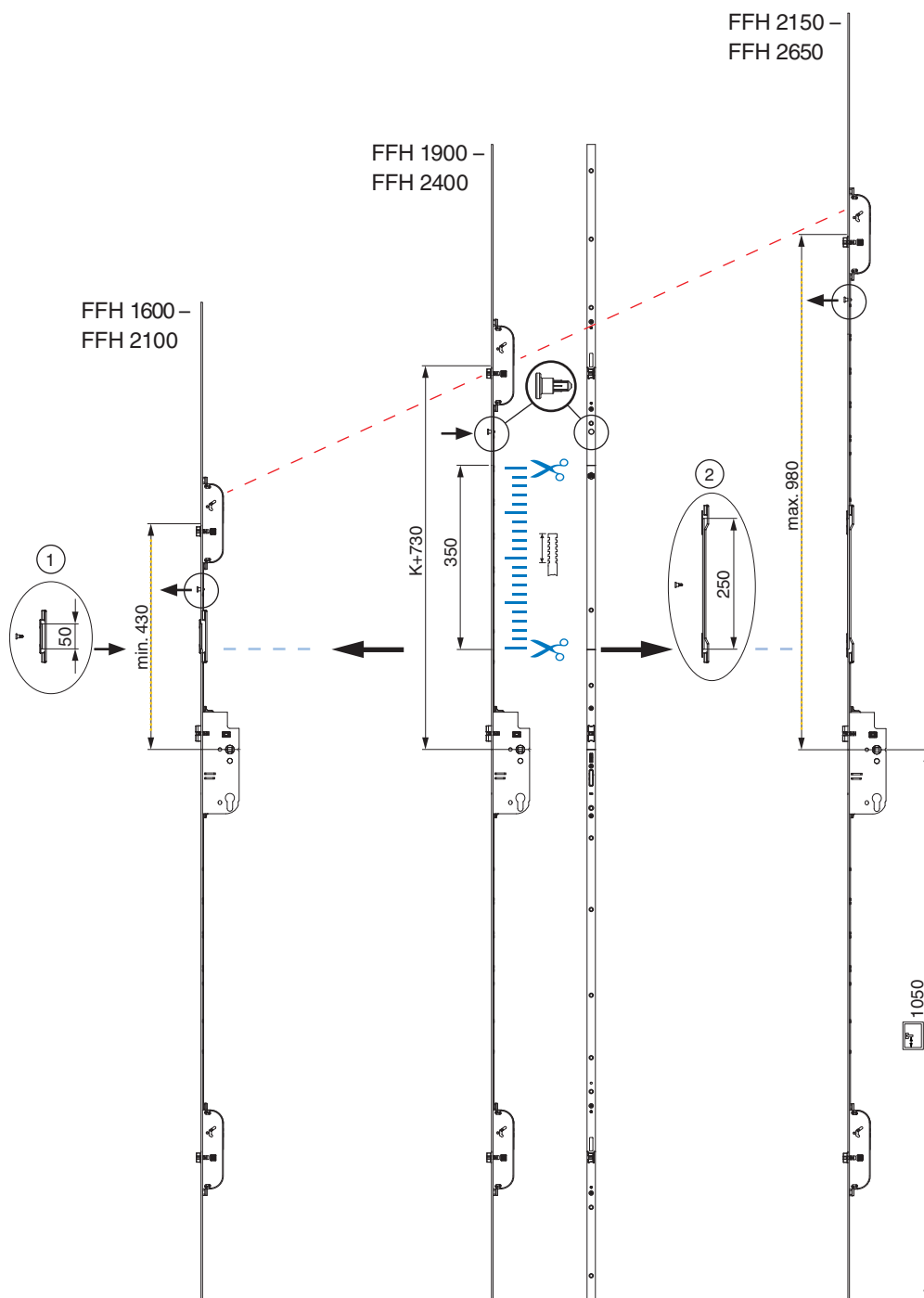



2 MF-HO  
1- & 2-sashed

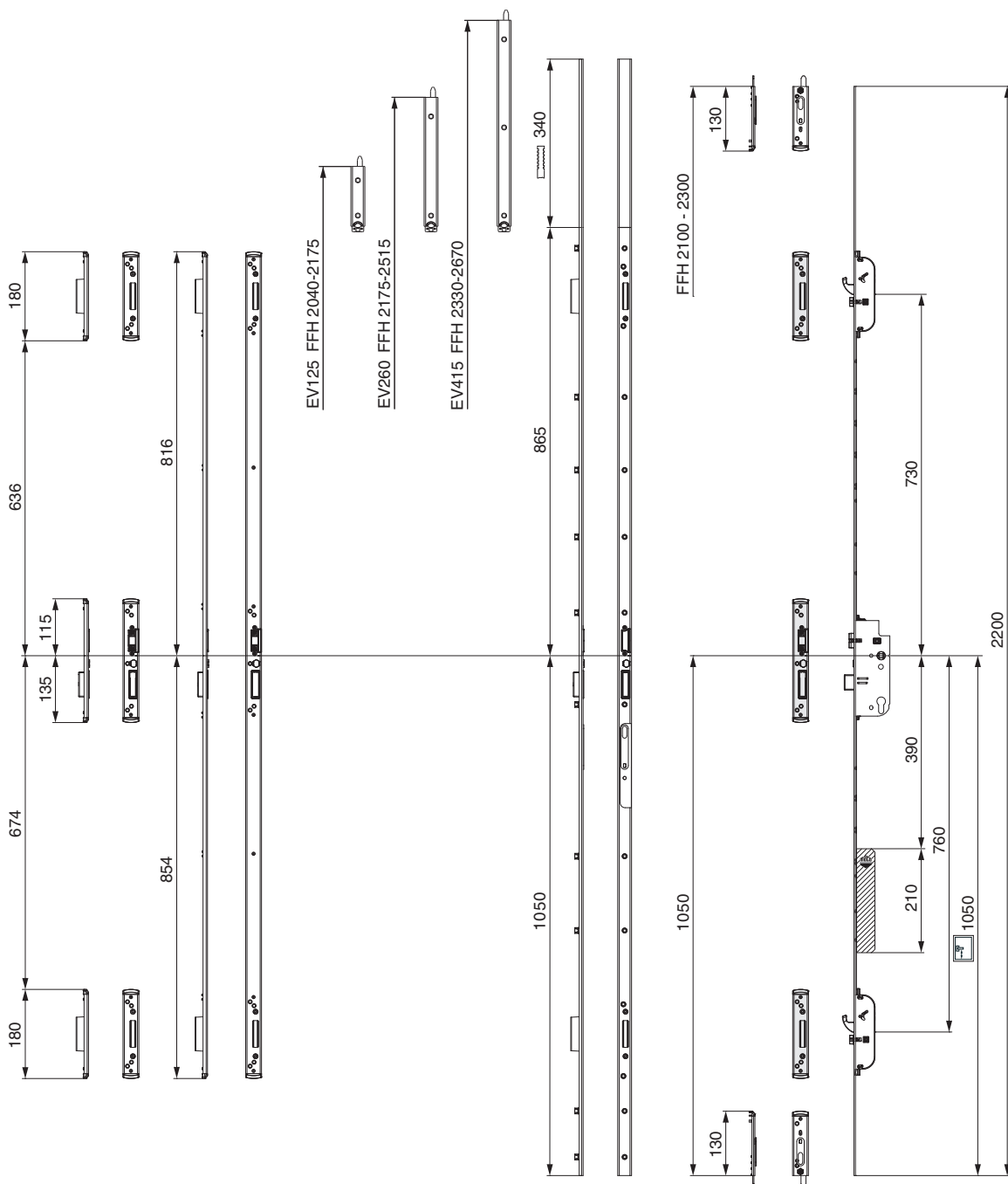

Motor for Comfort opening



2 MF-HO K+605

1- & 2-sashed

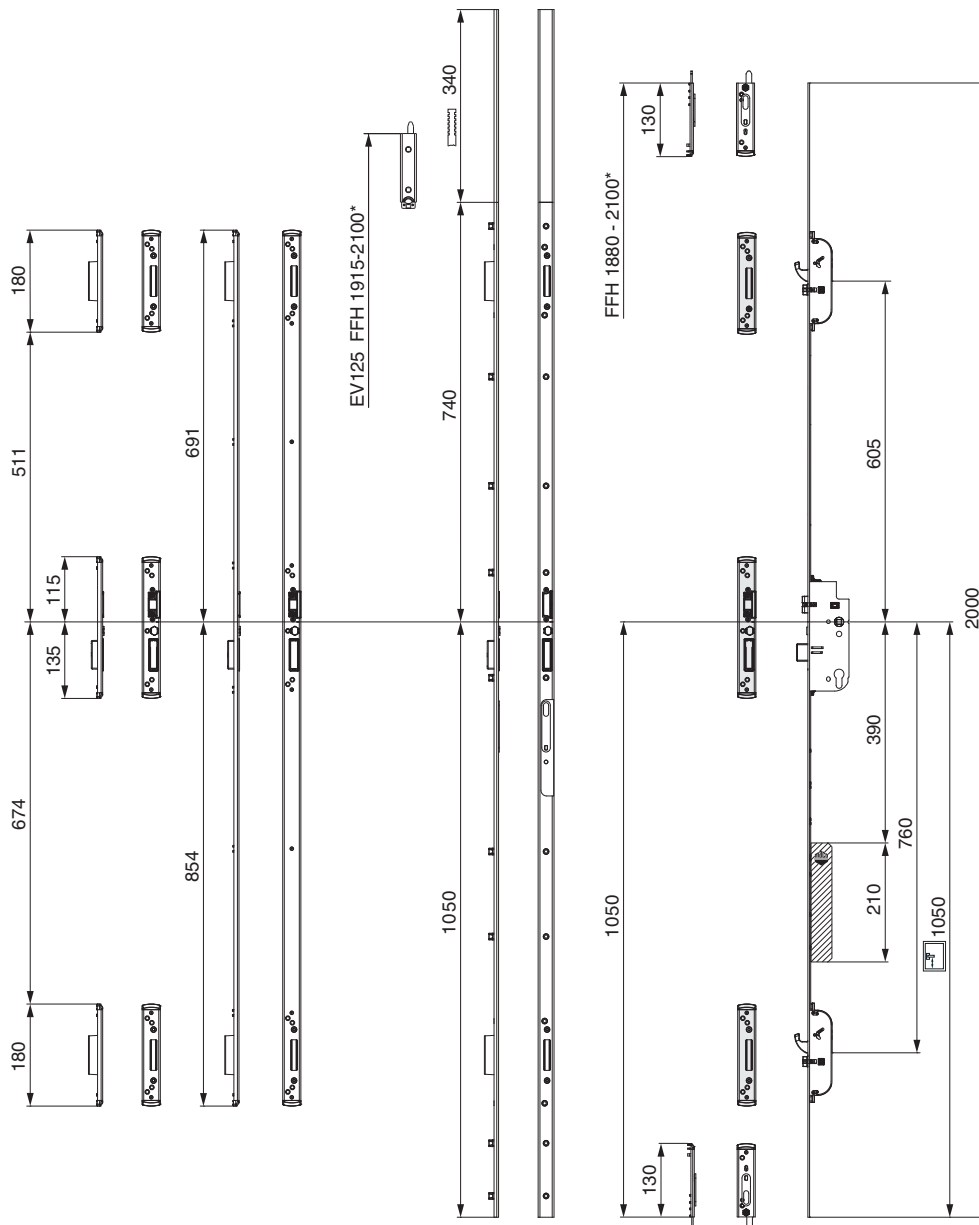

\* Please use cover plates for SRH above 2000 mm!

Motor for Comfort opening



2 MF-HO K+980

1- & 2-sashed

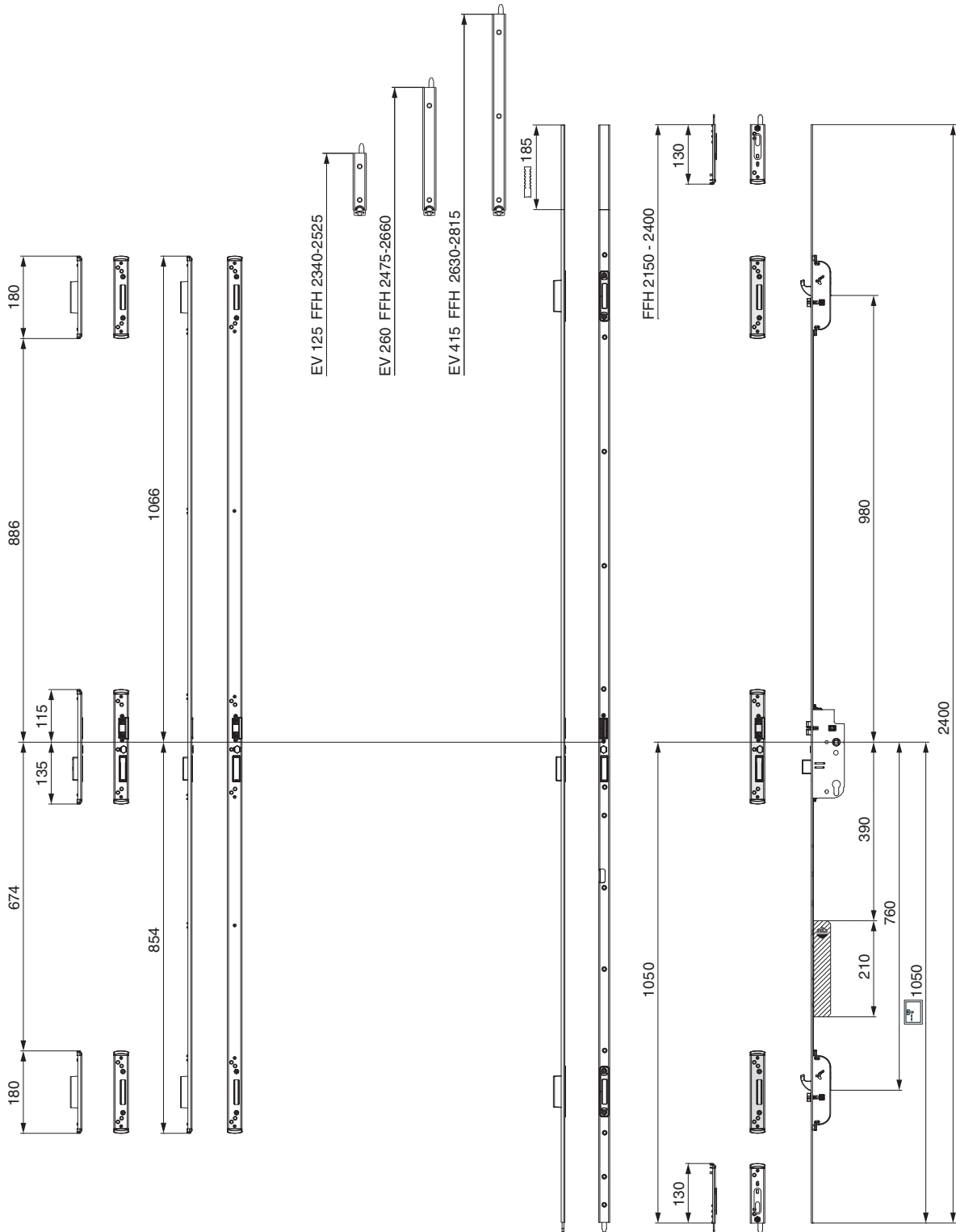

Motor for Comfort opening

## 2.2 Door lock Z-TA with 2 MF-HO

Flat faceplate 16 mm

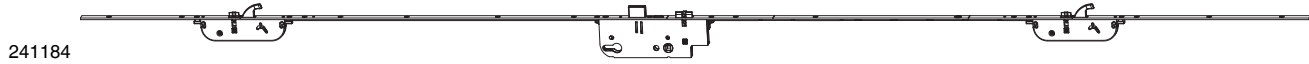

241184

### 2.2.1 Door lock Z-TA Automatic PT-M with 2 MF-HO E92 F-16



modular	silver	92	35	8	1.050	2.000 - 2.200	16	2.200	5	<b>No</b>
				10	1.050	2.000 - 2.200	16	2.200	5	<b>241180</b>
			40	8	1.050	2.000 - 2.200	16	2.200	5	<b>241181</b>
				10	1.050	2.000 - 2.200	16	2.200	5	<b>241651</b>
			45	8	1.050	2.000 - 2.200	16	2.200	5	<b>241182</b>
				10	1.050	2.000 - 2.200	16	2.200	5	<b>241652</b>
			50	8	1.050	2.000 - 2.200	16	2.200	5	<b>241183</b>
				10	1.050	2.000 - 2.200	16	2.200	5	<b>241653</b>
			55	8	1.050	2.000 - 2.200	16	2.200	5	<b>241184</b>
				10	1.050	2.000 - 2.200	16	2.200	5	<b>241654</b>
			60	8	1.050	2.000 - 2.200	16	2.200	5	<b>241185</b>
				10	1.050	2.000 - 2.200	16	2.200	5	<b>241655</b>
			65	8	1.050	2.000 - 2.200	16	2.200	5	<b>241186</b>
				10	1.050	2.000 - 2.200	16	2.200	5	<b>241656</b>
			70	8	1.050	2.000 - 2.200	16	2.200	5	<b>241187</b>
				10	1.050	2.000 - 2.200	16	2.200	5	<b>241657</b>
			80	8	1.050	2.000 - 2.200	16	2.200	5	<b>241188</b>
				10	1.050	2.000 - 2.200	16	2.200	5	<b>241658</b>



244742

### 2.2.2 Door lock Varia Z-TA Automatic PT-M with 2 MF-HO E92 F-16 HH1460



modular	silver	92	35	8	1.460	1.950 - 2.200	16	2.200	5	<b>No</b>
			45	8 <td>1.460 <td>1.950 - 2.200 <td>16 <td>2.200 <td>5 <td><b>244742</b></td> </td></td></td></td></td>	1.460 <td>1.950 - 2.200 <td>16 <td>2.200 <td>5 <td><b>244742</b></td> </td></td></td></td>	1.950 - 2.200 <td>16 <td>2.200 <td>5 <td><b>244742</b></td> </td></td></td>	16 <td>2.200 <td>5 <td><b>244742</b></td> </td></td>	2.200 <td>5 <td><b>244742</b></td> </td>	5 <td><b>244742</b></td>	<b>244742</b>



241314







### 2.2.3 Door lock Z-TA Automatic PT-M with 2 MF-HO E92 F-16 K+605



modular	silver	92	35	8	1.050	1.800 - 2.000	16	2.000	5	<b>No</b>
				10	1.050	1.800 - 2.000	16	2.000	5	<b>241700</b>
			40	8	1.050	1.800 - 2.000	16	2.000	5	<b>241311</b>
				10	1.050	1.800 - 2.000	16	2.000	5	<b>241701</b>
			45	8	1.050	1.800 - 2.000	16	2.000	5	<b>241312</b>
				10	1.050	1.800 - 2.000	16	2.000	5	<b>241702</b>
			50	8	1.050	1.800 - 2.000	16	2.000	5	<b>241313</b>
				10	1.050	1.800 - 2.000	16	2.000	5	<b>241703</b>
			55	8	1.050	1.800 - 2.000	16	2.000	5	<b>241314</b>
				10	1.050	1.800 - 2.000	16	2.000	5	<b>241704</b>
			60	8	1.050	1.800 - 2.000	16	2.000	5	<b>241315</b>
				10	1.050	1.800 - 2.000	16	2.000	5	<b>241705</b>
			65	8	1.050	1.800 - 2.000	16	2.000	5	<b>241316</b>
				10	1.050	1.800 - 2.000	16	2.000	5	<b>241706</b>
			70	8	1.050	1.800 - 2.000	16	2.000	5	<b>241317</b>
				10	1.050	1.800 - 2.000	16	2.000	5	<b>241707</b>
			80	8	1.050	1.800 - 2.000	16	2.000	5	<b>241318</b>
				10	1.050	1.800 - 2.000	16	2.000	5	<b>241708</b>

241444









<b>2.2.4 Door lock Z-TA Automatic PT-M with 2 MF-HO E92 F-16 K+980</b>								<b>L</b>		<b>No</b>
modular	silver	92	35	8	1.050	2.200 - 2.400	16	2.400	5	<b>241440</b>
				10	1.050	2.200 - 2.400	16	2.400	5	<b>241750</b>
			40	8	1.050	2.200 - 2.400	16	2.400	5	<b>241441</b>
				10	1.050	2.200 - 2.400	16	2.400	5	<b>241751</b>
			45	8	1.050	2.200 - 2.400	16	2.400	5	<b>241442</b>
				10	1.050	2.200 - 2.400	16	2.400	5	<b>241752</b>
			50	8	1.050	2.200 - 2.400	16	2.400	5	<b>241443</b>
				10	1.050	2.200 - 2.400	16	2.400	5	<b>241753</b>
			55	8	1.050	2.200 - 2.400	16	2.400	5	<b>241444</b>
				10	1.050	2.200 - 2.400	16	2.400	5	<b>241754</b>
			60	8	1.050	2.200 - 2.400	16	2.400	5	<b>241445</b>
				10	1.050	2.200 - 2.400	16	2.400	5	<b>241755</b>
			65	8	1.050	2.200 - 2.400	16	2.400	5	<b>241446</b>
				10	1.050	2.200 - 2.400	16	2.400	5	<b>241756</b>
			70	8	1.050	2.200 - 2.400	16	2.400	5	<b>241447</b>
				10	1.050	2.200 - 2.400	16	2.400	5	<b>241757</b>
			80	8	1.050	2.200 - 2.400	16	2.400	5	<b>241448</b>
				10	1.050	2.200 - 2.400	16	2.400	5	<b>241758</b>

## Flat faceplate 20 mm

241214



<b>2.2.5 Door lock Z-TA Automatic PT-M with 2 MF-HO E92 F-20</b>								<b>L</b>		<b>No</b>
modular	silver	92	35	8	1.050	2.000 - 2.200	20	2.200	5	<b>241210</b>
				10	1.050	2.000 - 2.200	20	2.200	5	<b>241660</b>
			40	8	1.050	2.000 - 2.200	20	2.200	5	<b>241211</b>
				10	1.050	2.000 - 2.200	20	2.200	5	<b>241661</b>
			45	8	1.050	2.000 - 2.200	20	2.200	5	<b>241212</b>
				10	1.050	2.000 - 2.200	20	2.200	5	<b>241662</b>
			50	8	1.050	2.000 - 2.200	20	2.200	5	<b>241213</b>
				10	1.050	2.000 - 2.200	20	2.200	5	<b>241663</b>
			55	8	1.050	2.000 - 2.200	20	2.200	5	<b>241214</b>
				10	1.050	2.000 - 2.200	20	2.200	5	<b>241664</b>
			60	8	1.050	2.000 - 2.200	20	2.200	5	<b>241215</b>
				10	1.050	2.000 - 2.200	20	2.200	5	<b>241665</b>
			65	8	1.050	2.000 - 2.200	20	2.200	5	<b>241216</b>
				10	1.050	2.000 - 2.200	20	2.200	5	<b>241666</b>
			70	8	1.050	2.000 - 2.200	20	2.200	5	<b>241217</b>
				10	1.050	2.000 - 2.200	20	2.200	5	<b>241667</b>
			80	8	1.050	2.000 - 2.200	20	2.200	5	<b>241218</b>
				10	1.050	2.000 - 2.200	20	2.200	5	<b>241668</b>



241344



<b>2.2.6 Door lock Z-TA Automatic PT-M with 2 MF-HO E92 F-20 K+605</b>										<b>No</b>
modular	silver	92	35	8	1.050	1.800 - 2.000	20	2.000	5	<b>241340</b>
				10	1.050	1.800 - 2.000	20	2.000	5	<b>241710</b>
		40	8	1.050	1.800 - 2.000	20	2.000	5	<b>241341</b>	
			10	1.050	1.800 - 2.000	20	2.000	5	<b>241711</b>	
		45	8	1.050	1.800 - 2.000	20	2.000	5	<b>241342</b>	
			10	1.050	1.800 - 2.000	20	2.000	5	<b>241712</b>	
		50	8	1.050	1.800 - 2.000	20	2.000	5	<b>241343</b>	
			10	1.050	1.800 - 2.000	20	2.000	5	<b>241713</b>	
		55	8	1.050	1.800 - 2.000	20	2.000	5	<b>241344</b>	
			10	1.050	1.800 - 2.000	20	2.000	5	<b>241714</b>	
		60	8	1.050	1.800 - 2.000	20	2.000	5	<b>241345</b>	
			10	1.050	1.800 - 2.000	20	2.000	5	<b>241715</b>	
		65	8	1.050	1.800 - 2.000	20	2.000	5	<b>241346</b>	
			10	1.050	1.800 - 2.000	20	2.000	5	<b>241716</b>	
		70	8	1.050	1.800 - 2.000	20	2.000	5	<b>241347</b>	
			10	1.050	1.800 - 2.000	20	2.000	5	<b>241717</b>	
		80	8	1.050	1.800 - 2.000	20	2.000	5	<b>241348</b>	
			10	1.050	1.800 - 2.000	20	2.000	5	<b>241718</b>	







241474

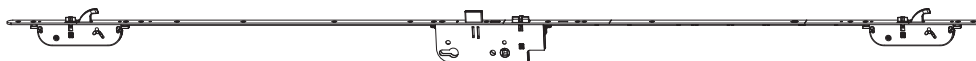

<b>2.2.7 Door lock Z-TA Automatic PT-M with 2 MF-HO E92 F-20 K+980</b>										<b>No</b>
modular	silver	92	35	8	1.050	2.200 - 2.400	20	2.400	5	<b>241470</b>
				10	1.050	2.200 - 2.400	20	2.400	5	<b>241760</b>
		40	8	1.050	2.200 - 2.400	20	2.400	5	<b>241471</b>	
			10	1.050	2.200 - 2.400	20	2.400	5	<b>241761</b>	
		45	8	1.050	2.200 - 2.400	20	2.400	5	<b>241472</b>	
			10	1.050	2.200 - 2.400	20	2.400	5	<b>241762</b>	
		50	8	1.050	2.200 - 2.400	20	2.400	5	<b>241473</b>	
			10	1.050	2.200 - 2.400	20	2.400	5	<b>241763</b>	
		55	8	1.050	2.200 - 2.400	20	2.400	5	<b>241474</b>	
			10	1.050	2.200 - 2.400	20	2.400	5	<b>241764</b>	
		60	8	1.050	2.200 - 2.400	20	2.400	5	<b>241475</b>	
			10	1.050	2.200 - 2.400	20	2.400	5	<b>241765</b>	
		65	8	1.050	2.200 - 2.400	20	2.400	5	<b>241476</b>	
			10	1.050	2.200 - 2.400	20	2.400	5	<b>241766</b>	
		70	8	1.050	2.200 - 2.400	20	2.400	5	<b>241477</b>	
			10	1.050	2.200 - 2.400	20	2.400	5	<b>241767</b>	
		80	8	1.050	2.200 - 2.400	20	2.400	5	<b>241478</b>	
			10	1.050	2.200 - 2.400	20	2.400	5	<b>241768</b>	







241674

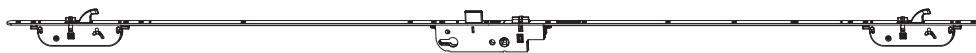

<b>2.2.8 Door lock Z-TA Automatic PT-M with 2 MF-HO E92 R20 HH 890</b>								<b>L</b>		<b>No</b>
modular	silver	92	35	8	890	1.950 - 2.000	20 / R	1.750	5	<b>241670</b>
			45	8	890	1.950 - 2.000	20 / R	1.750	5	<b>241672</b>
		55	8	890	1.950 - 2.000	20 / R	1.750	5	<b>241674</b>	
			10	890	1.950 - 2.000	20 / R	1.750	5	<b>241224</b>	
		60	8	890	1.950 - 2.000	20 / R	1.750	5	<b>241675</b>	
			10	890	1.950 - 2.000	20 / R	1.750	5	<b>241225</b>	
		65	8	890	1.950 - 2.000	20 / R	1.750	5	<b>241676</b>	
			10	890	1.950 - 2.000	20 / R	1.750	5	<b>241226</b>	
		70	8	890	1.950 - 2.000	20 / R	1.750	5	<b>241677</b>	
			10	890	1.950 - 2.000	20 / R	1.750	5	<b>241227</b>	
		80	8	890	1.950 - 2.000	20 / R	1.750	5	<b>241678</b>	
			10	890	1.950 - 2.000	20 / R	1.750	5	<b>241228</b>	







244582



<b>2.2.9 Door lock Varia Z-TA Automatic PT-M with 2 MF-HO E92 R20 HH890</b>								<b>L</b>		<b>No</b>
modular	silver	92	35	8	890	1.950 - 2.400	20 / R	1.750	5	<b>244580</b>
			45	8	890	1.950 - 2.400	20 / R	1.750	5	<b>244582</b>

244592









<b>2.2.10 Door lock Varia Z-TA Automatic PT-M with 2 MF-HO E92 R20 HH1300</b>								<b>L</b>		<b>No</b>
modular	silver	92	35	8	1.300	1.950 - 2.400	20 / R	1.750	5	<b>244590</b>
			45	8	1.300	1.950 - 2.400	20 / R	1.750	5	<b>244592</b>

### Flat faceplate 24 mm

241254



<b>2.2.11 Door lock Z-TA Automatic PT-M with 2 MF-HO E92 F-24</b>								<b>L</b>		<b>No</b>
modular	silver	92	35	8	1.050	2.000 - 2.200	24	2.200	5	<b>241250</b>
				10	1.050	2.000 - 2.200	24	2.200	5	<b>241680</b>
			40	8	1.050	2.000 - 2.200	24	2.200	5	<b>241251</b>
				10	1.050	2.000 - 2.200	24	2.200	5	<b>241681</b>
			45	8	1.050	2.000 - 2.200	24	2.200	5	<b>241252</b>
				10	1.050	2.000 - 2.200	24	2.200	5	<b>241682</b>
			50	8	1.050	2.000 - 2.200	24	2.200	5	<b>241253</b>
				10	1.050	2.000 - 2.200	24	2.200	5	<b>241683</b>
			55	8	1.050	2.000 - 2.200	24	2.200	5	<b>241254</b>
				10	1.050	2.000 - 2.200	24	2.200	5	<b>241684</b>
			60	8	1.050	2.000 - 2.200	24	2.200	5	<b>241255</b>
				10	1.050	2.000 - 2.200	24	2.200	5	<b>241685</b>
			65	8	1.050	2.000 - 2.200	24	2.200	5	<b>241256</b>
				10	1.050	2.000 - 2.200	24	2.200	5	<b>241686</b>
			70	8	1.050	2.000 - 2.200	24	2.200	5	<b>241257</b>
				10	1.050	2.000 - 2.200	24	2.200	5	<b>241687</b>
			80	8	1.050	2.000 - 2.200	24	2.200	5	<b>241258</b>
				10	1.050	2.000 - 2.200	24	2.200	5	<b>241688</b>



241384



<b>2.2.12 Door lock Z-TA Automatic PT-M with 2 MF-HO E92 F-24 K+605</b>										<b>No</b>
modular	silver	92	35	8	1.050	1.800 - 2.000	24	2.000	5	<b>241380</b>
				10	1.050	1.800 - 2.000	24	2.000	5	<b>241730</b>
		40	8	1.050	1.800 - 2.000	24	2.000	5	<b>241381</b>	
			10	1.050	1.800 - 2.000	24	2.000	5	<b>241731</b>	
		45	8	1.050	1.800 - 2.000	24	2.000	5	<b>241382</b>	
			10	1.050	1.800 - 2.000	24	2.000	5	<b>241732</b>	
		50	8	1.050	1.800 - 2.000	24	2.000	5	<b>241383</b>	
			10	1.050	1.800 - 2.000	24	2.000	5	<b>241733</b>	
		55	8	1.050	1.800 - 2.000	24	2.000	5	<b>241384</b>	
			10	1.050	1.800 - 2.000	24	2.000	5	<b>241734</b>	
		60	8	1.050	1.800 - 2.000	24	2.000	5	<b>241385</b>	
			10	1.050	1.800 - 2.000	24	2.000	5	<b>241735</b>	
		65	8	1.050	1.800 - 2.000	24	2.000	5	<b>241386</b>	
			10	1.050	1.800 - 2.000	24	2.000	5	<b>241736</b>	
		70	8	1.050	1.800 - 2.000	24	2.000	5	<b>241387</b>	
			10	1.050	1.800 - 2.000	24	2.000	5	<b>241737</b>	
		80	8	1.050	1.800 - 2.000	24	2.000	5	<b>241388</b>	
			10	1.050	1.800 - 2.000	24	2.000	5	<b>241738</b>	

241514



<b>2.2.13 Door lock Z-TA Automatic PT-M with 2 MF-HO E92 F-24 K+980</b>										<b>No</b>
modular	silver	92	35	8	1.050	2.200 - 2.400	24	2.400	5	<b>241510</b>
				10	1.050	2.200 - 2.400	24	2.400	5	<b>241780</b>
		40	8	1.050	2.200 - 2.400	24	2.400	5	<b>241511</b>	
			10	1.050	2.200 - 2.400	24	2.400	5	<b>241781</b>	
		45	8	1.050	2.200 - 2.400	24	2.400	5	<b>241512</b>	
			10	1.050	2.200 - 2.400	24	2.400	5	<b>241782</b>	
		50	8	1.050	2.200 - 2.400	24	2.400	5	<b>241513</b>	
			10	1.050	2.200 - 2.400	24	2.400	5	<b>241783</b>	
		55	8	1.050	2.200 - 2.400	24	2.400	5	<b>241514</b>	
			10	1.050	2.200 - 2.400	24	2.400	5	<b>241784</b>	
		60	8	1.050	2.200 - 2.400	24	2.400	5	<b>241515</b>	
			10	1.050	2.200 - 2.400	24	2.400	5	<b>241785</b>	
		65	8	1.050	2.200 - 2.400	24	2.400	5	<b>241516</b>	
			10	1.050	2.200 - 2.400	24	2.400	5	<b>241786</b>	
		70	8	1.050	2.200 - 2.400	24	2.400	5	<b>241517</b>	
			10	1.050	2.200 - 2.400	24	2.400	5	<b>241787</b>	
		80	8	1.050	2.200 - 2.400	24	2.400	5	<b>241518</b>	
			10	1.050	2.200 - 2.400	24	2.400	5	<b>241788</b>	

## Top hat faceplate 24/16 mm

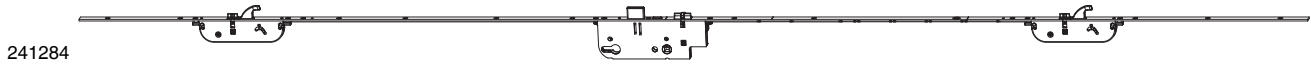

241284

### 2.2.14 Door lock Z-TA Automatic PT-M with 2 MF-HO E92 F-24/16 top-hat faceplate



modular	silver	92	35	8	1.050	2.000 - 2.200	24/16	2.200	5	No
				10	1.050	2.000 - 2.200	24/16	2.200	5	241280
			40	8	1.050	2.000 - 2.200	24/16	2.200	5	241281
				10	1.050	2.000 - 2.200	24/16	2.200	5	241691
			45	8	1.050	2.000 - 2.200	24/16	2.200	5	241282
				10	1.050	2.000 - 2.200	24/16	2.200	5	241692
			50	8	1.050	2.000 - 2.200	24/16	2.200	5	241283
				10	1.050	2.000 - 2.200	24/16	2.200	5	241693
			55	8	1.050	2.000 - 2.200	24/16	2.200	5	241284
				10	1.050	2.000 - 2.200	24/16	2.200	5	241694
			60	8	1.050	2.000 - 2.200	24/16	2.200	5	241285
				10	1.050	2.000 - 2.200	24/16	2.200	5	241695
			65	8	1.050	2.000 - 2.200	24/16	2.200	5	241286
				10	1.050	2.000 - 2.200	24/16	2.200	5	241696
			70	8	1.050	2.000 - 2.200	24/16	2.200	5	241287
				10	1.050	2.000 - 2.200	24/16	2.200	5	241697
			80	8	1.050	2.000 - 2.200	24/16	2.200	5	241288
				10	1.050	2.000 - 2.200	24/16	2.200	5	241698

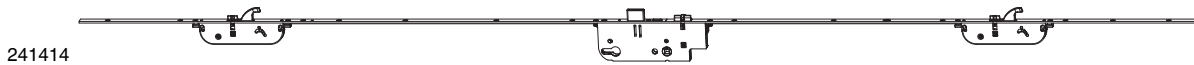

241414

### 2.2.15 Door lock Z-TA Automatic PT-M with 2 MF-HO E92 F-24/16 K+605



modular	silver	92	35	8	1.050	1.800 - 2.000	24/16	2.000	5	No
				10	1.050	1.800 - 2.000	24/16	2.000	5	241410
			40	8	1.050	1.800 - 2.000	24/16	2.000	5	241411
				10	1.050	1.800 - 2.000	24/16	2.000	5	241741
			45	8	1.050	1.800 - 2.000	24/16	2.000	5	241412
				10	1.050	1.800 - 2.000	24/16	2.000	5	241742
			50	8	1.050	1.800 - 2.000	24/16	2.000	5	241413
				10	1.050	1.800 - 2.000	24/16	2.000	5	241743
			55	8	1.050	1.800 - 2.000	24/16	2.000	5	241414
				10	1.050	1.800 - 2.000	24/16	2.000	5	241744
			60	8	1.050	1.800 - 2.000	24/16	2.000	5	241415
				10	1.050	1.800 - 2.000	24/16	2.000	5	241745
			65	8	1.050	1.800 - 2.000	24/16	2.000	5	241416
				10	1.050	1.800 - 2.000	24/16	2.000	5	241746
			70	8	1.050	1.800 - 2.000	24/16	2.000	5	241417
				10	1.050	1.800 - 2.000	24/16	2.000	5	241747
			80	8	1.050	1.800 - 2.000	24/16	2.000	5	241418
				10	1.050	1.800 - 2.000	24/16	2.000	5	241748

241544



**2.2.16 Door lock Z-TA Automatic PT-M with 2 MF-HO E92 F-24/16 K+980**



modular	silver	92	35	8	1.050	2.200 - 2.400	24/16	2.400	5	<b>No</b>
				10	1.050	2.200 - 2.400	24/16	2.400	5	<b>241540</b>
			40	8	1.050	2.200 - 2.400	24/16	2.400	5	<b>241541</b>
				10	1.050	2.200 - 2.400	24/16	2.400	5	<b>241791</b>
			45	8	1.050	2.200 - 2.400	24/16	2.400	5	<b>241542</b>
				10	1.050	2.200 - 2.400	24/16	2.400	5	<b>241792</b>
			50	8	1.050	2.200 - 2.400	24/16	2.400	5	<b>241543</b>
				10	1.050	2.200 - 2.400	24/16	2.400	5	<b>241793</b>
			55	8	1.050	2.200 - 2.400	24/16	2.400	5	<b>241544</b>
				10	1.050	2.200 - 2.400	24/16	2.400	5	<b>241794</b>
			60	8	1.050	2.200 - 2.400	24/16	2.400	5	<b>241545</b>
				10	1.050	2.200 - 2.400	24/16	2.400	5	<b>241795</b>
			65	8	1.050	2.200 - 2.400	24/16	2.400	5	<b>241546</b>
				10	1.050	2.200 - 2.400	24/16	2.400	5	<b>241796</b>
			70	8	1.050	2.200 - 2.400	24/16	2.400	5	<b>241547</b>
				10	1.050	2.200 - 2.400	24/16	2.400	5	<b>241797</b>
			80	8	1.050	2.200 - 2.400	24/16	2.400	5	<b>241548</b>
				10	1.050	2.200 - 2.400	24/16	2.400	5	<b>241798</b>

**U-faceplate 6x24x6 mm**

241574

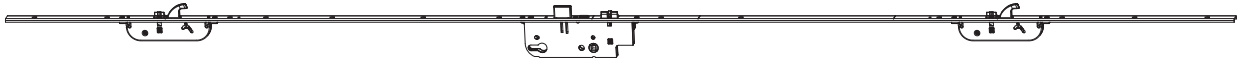

**2.2.17 Door lock Z-TA Automatic PT-M with 2 MF-HO E92 U-6x24x6**



modular	silver	92	35	8	1.050	2.000 - 2.200	24	2.200	5	<b>No</b>
				10	1.050	2.000 - 2.200	24	2.200	5	<b>241800</b>
			40	8	1.050	2.000 - 2.200	24	2.200	5	<b>241571</b>
				10	1.050	2.000 - 2.200	24	2.200	5	<b>241801</b>
			45	8	1.050	2.000 - 2.200	24	2.200	5	<b>241572</b>
				10	1.050	2.000 - 2.200	24	2.200	5	<b>241802</b>
			50	8	1.050	2.000 - 2.200	24	2.200	5	<b>241573</b>
				10	1.050	2.000 - 2.200	24	2.200	5	<b>241803</b>
			55	8	1.050	2.000 - 2.200	24	2.200	5	<b>241574</b>
				10	1.050	2.000 - 2.200	24	2.200	5	<b>241804</b>

242784

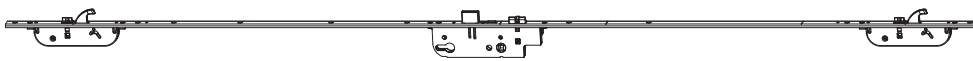







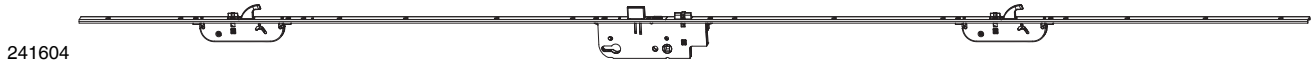



**2.2.18 Door lock Z-TA Automatic PT-M with 2 MF-HO E92 U-6x24x6 HH885**



modular	silver	92	35	8	885	2.000 - 2.200	24	1.740	5	<b>No</b>
				10	885	2.000 - 2.200	24	1.740	5	<b>242790</b>
			40	8	885	2.000 - 2.200	24	1.740	5	<b>242781</b>
				10	885	2.000 - 2.200	24	1.740	5	<b>242791</b>
			45	8	885	2.000 - 2.200	24	1.740	5	<b>242782</b>
				10	885	2.000 - 2.200	24	1.740	5	<b>242792</b>
			50	8	885	2.000 - 2.200	24	1.740	5	<b>242783</b>
				10	885	2.000 - 2.200	24	1.740	5	<b>242793</b>
			55	8	885	2.000 - 2.200	24	1.740	5	<b>242784</b>













241604

<b>2.2.19 Door lock Z-TA Automatic PT-M with 2 MF-HO E92 U-6x24x6 K+605</b>												<b>No</b>
modular	silver	92	35	8	1.050	1.800 - 2.000	24	2.200	5			<b>241600</b>
				10	1.050	1.800 - 2.000	24	2.200	5			<b>241810</b>
		40	8	1.050	1.800 - 2.000	24	2.200	5			<b>241601</b>	
				10	1.050	1.800 - 2.000	24	2.200	5			<b>241811</b>
		45	8	1.050	1.800 - 2.000	24	2.200	5			<b>241602</b>	
				10	1.050	1.800 - 2.000	24	2.200	5			<b>241812</b>
		50	8	1.050	1.800 - 2.000	24	2.200	5			<b>241603</b>	
				10	1.050	1.800 - 2.000	24	2.200	5			<b>241813</b>
		55	8	1.050	1.800 - 2.000	24	2.200	5			<b>241604</b>	
				10	1.050	1.800 - 2.000	24	2.200	5			<b>241814</b>







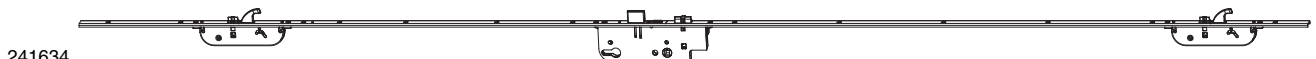





242804

<b>2.2.20 Door lock Z-TA Automatic PT-M with 2 MF-HO E92 U-6x24x6 K+605 HH885</b>												<b>No</b>
modular	silver	92	35	8	885	1.800 - 2.000	24	1.615	5			<b>242800</b>
				10	885	1.800 - 2.000	24	1.615	5			<b>242810</b>
		40	8	885	1.800 - 2.000	24	1.615	5			<b>242801</b>	
				10	885	1.800 - 2.000	24	1.615	5			<b>242811</b>
		45	8	885	1.800 - 2.000	24	1.615	5			<b>242802</b>	
				10	885	1.800 - 2.000	24	1.615	5			<b>242812</b>
		50	8	885	1.800 - 2.000	24	1.615	5			<b>242803</b>	
				10	885	1.800 - 2.000	24	1.615	5			<b>242813</b>
		55	8	885	1.800 - 2.000	24	1.615	5			<b>242804</b>	
				10	885	1.800 - 2.000	24	1.615	5			<b>242814</b>



241634

<b>2.2.21 Door lock Z-TA Automatic PT-M with 2 MF-HO E92 U-6x24x6 K+980</b>												<b>No</b>
modular	silver	92	35	8	1.050	2.200 - 2.400	24	2.200	5			<b>241630</b>
				10	1.050	2.200 - 2.400	24	2.200	5			<b>241820</b>
		40	8	1.050	2.200 - 2.400	24	2.200	5			<b>241631</b>	
				10	1.050	2.200 - 2.400	24	2.200	5			<b>241821</b>
		45	8	1.050	2.200 - 2.400	24	2.200	5			<b>241632</b>	
				10	1.050	2.200 - 2.400	24	2.200	5			<b>241822</b>
		50	8	1.050	2.200 - 2.400	24	2.200	5			<b>241633</b>	
				10	1.050	2.200 - 2.400	24	2.200	5			<b>241823</b>
		55	8	1.050	2.200 - 2.400	24	2.200	5			<b>241634</b>	
				10	1.050	2.200 - 2.400	24	2.200	5			<b>241824</b>

242824



**2.2.22 Door lock Z-TA Automatic PT-M with 2 MF-HO E92 U-6x24x6 K+980 HH885**



modular	silver	92	35	8	885	2.200 - 2.400	24	1.990	5	<b>No</b>
					10	885	2.200 - 2.400	24	1.990	<b>242820</b>
			40	8	885	2.200 - 2.400	24	1.990	5	<b>242821</b>
					10	885	2.200 - 2.400	24	1.990	<b>242831</b>
			45	8	885	2.200 - 2.400	24	1.990	5	<b>242822</b>
					10	885	2.200 - 2.400	24	1.990	<b>242832</b>
			50	8	885	2.200 - 2.400	24	1.990	5	<b>242823</b>
					10	885	2.200 - 2.400	24	1.990	<b>242833</b>
			55	8	885	2.200 - 2.400	24	1.990	5	<b>242824</b>
					10	885	2.200 - 2.400	24	1.990	<b>242834</b>

**Flat faceplate 16 mm**

241194



**2.2.23 Door lock Z-TA Automatic PT-M with 2 MF-HO E94 F-16**



modular	silver	94	35	9	1.050	2.000 - 2.200	16	2.200	5	<b>No</b>
			40	9	1.050	2.000 - 2.200	16	2.200	5	<b>241191</b>
			45	9	1.050	2.000 - 2.200	16	2.200	5	<b>241192</b>
			50	9	1.050	2.000 - 2.200	16	2.200	5	<b>241193</b>
			55	9	1.050	2.000 - 2.200	16	2.200	5	<b>241194</b>
			60	9	1.050	2.000 - 2.200	16	2.200	5	<b>241195</b>
			65	9	1.050	2.000 - 2.200	16	2.200	5	<b>241196</b>
			70	9	1.050	2.000 - 2.200	16	2.200	5	<b>241197</b>
			80	9	1.050	2.000 - 2.200	16	2.200	5	<b>241198</b>

241324









**2.2.24 Door lock Z-TA Automatic PT-M with 2 MF-HO E94 F-16 K+605**



modular	silver	94	35	9	1.050	1.800 - 2.000	16	2.000	5	<b>No</b>
			40	9	1.050	1.800 - 2.000	16	2.000	5	<b>241321</b>
			45	9	1.050	1.800 - 2.000	16	2.000	5	<b>241322</b>
			50	9	1.050	1.800 - 2.000	16	2.000	5	<b>241323</b>
			55	9	1.050	1.800 - 2.000	16	2.000	5	<b>241324</b>
			60	9	1.050	1.800 - 2.000	16	2.000	5	<b>241325</b>
			65	9	1.050	1.800 - 2.000	16	2.000	5	<b>241326</b>
			70	9	1.050	1.800 - 2.000	16	2.000	5	<b>241327</b>
			80	9	1.050	1.800 - 2.000	16	2.000	5	<b>241328</b>

241454









<b>2.2.25 Door lock Z-TA Automatic PT-M with 2 MF-HO E94 F-16 K+980</b>							<b>L</b>		<b>No</b>	
modular	silver	94	35	9	1.050	2.200 - 2.400	16	2.400	5	<b>241450</b>
			40	9	1.050	2.200 - 2.400	16	2.400	5	<b>241451</b>
			45	9	1.050	2.200 - 2.400	16	2.400	5	<b>241452</b>
			50	9	1.050	2.200 - 2.400	16	2.400	5	<b>241453</b>
			55	9	1.050	2.200 - 2.400	16	2.400	5	<b>241454</b>
			60	9	1.050	2.200 - 2.400	16	2.400	5	<b>241455</b>
			65	9	1.050	2.200 - 2.400	16	2.400	5	<b>241456</b>
			70	9	1.050	2.200 - 2.400	16	2.400	5	<b>241457</b>
			80	9	1.050	2.200 - 2.400	16	2.400	5	<b>241458</b>

### Flat faceplate 20 mm







241234

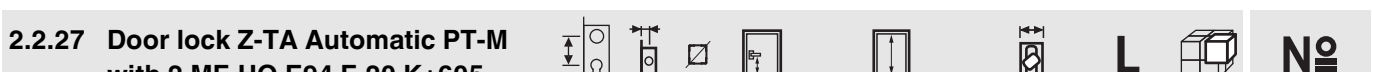

<b>2.2.26 Door lock Z-TA Automatic PT-M with 2 MF-HO E94 F-20</b>							<b>L</b>		<b>No</b>	
modular	silver	94	35	9	1.050	2.000 - 2.200	20	2.200	5	<b>241230</b>
			40	9	1.050	2.000 - 2.200	20	2.200	5	<b>241231</b>
			45	9	1.050	2.000 - 2.200	20	2.200	5	<b>241232</b>
			50	9	1.050	2.000 - 2.200	20	2.200	5	<b>241233</b>
			55	9	1.050	2.000 - 2.200	20	2.200	5	<b>241234</b>
			60	9	1.050	2.000 - 2.200	20	2.200	5	<b>241235</b>
			65	9	1.050	2.000 - 2.200	20	2.200	5	<b>241236</b>
			70	9	1.050	2.000 - 2.200	20	2.200	5	<b>241237</b>
			80	9	1.050	2.000 - 2.200	20	2.200	5	<b>241238</b>

241364



<b>2.2.27 Door lock Z-TA Automatic PT-M with 2 MF-HO E94 F-20 K+605</b>							<b>L</b>		<b>No</b>	
modular	silver	94	35	9	1.050	1.800 - 2.000	20	2.000	5	<b>241360</b>
			40	9	1.050	1.800 - 2.000	20	2.000	5	<b>241361</b>
			45	9	1.050	1.800 - 2.000	20	2.000	5	<b>241362</b>
			50	9	1.050	1.800 - 2.000	20	2.000	5	<b>241363</b>
			55	9	1.050	1.800 - 2.000	20	2.000	5	<b>241364</b>
			60	9	1.050	1.800 - 2.000	20	2.000	5	<b>241365</b>
			65	9	1.050	1.800 - 2.000	20	2.000	5	<b>241366</b>
			70	9	1.050	1.800 - 2.000	20	2.000	5	<b>241367</b>
			80	9	1.050	1.800 - 2.000	20	2.000	5	<b>241368</b>

241494



**2.2.28 Door lock Z-TA Automatic PT-M with 2 MF-HO E94 F-20 K+980**



modular	silver	94	35	9	1.050	2.200 - 2.400	20	2.400	5	<b>№</b>
			40	9	1.050	2.200 - 2.400	20	2.400	5	<b>241490</b>
			45	9	1.050	2.200 - 2.400	20	2.400	5	<b>241491</b>
			50	9	1.050	2.200 - 2.400	20	2.400	5	<b>241492</b>
			55	9	1.050	2.200 - 2.400	20	2.400	5	<b>241493</b>
			60	9	1.050	2.200 - 2.400	20	2.400	5	<b>241494</b>
			65	9	1.050	2.200 - 2.400	20	2.400	5	<b>241495</b>
			70	9	1.050	2.200 - 2.400	20	2.400	5	<b>241496</b>
			70	9	1.050	2.200 - 2.400	20	2.400	5	<b>241497</b>
			80	9	1.050	2.200 - 2.400	20	2.400	5	<b>241498</b>

Flat faceplate 24 mm

241264

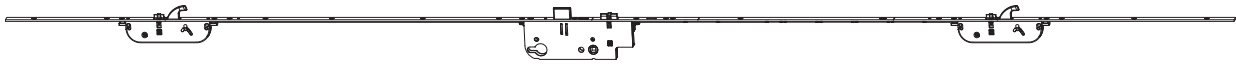

**2.2.29 Door lock Z-TA Automatic PT-M with 2 MF-HO E94 F-24**



modular	silver	94	35	9	1.050	2.000 - 2.200	24	2.200	5	<b>№</b>
			40	9	1.050	2.000 - 2.200	24	2.200	5	<b>241260</b>
			45	9	1.050	2.000 - 2.200	24	2.200	5	<b>241261</b>
			50	9	1.050	2.000 - 2.200	24	2.200	5	<b>241262</b>
			55	9	1.050	2.000 - 2.200	24	2.200	5	<b>241263</b>
			60	9	1.050	2.000 - 2.200	24	2.200	5	<b>241264</b>
			65	9	1.050	2.000 - 2.200	24	2.200	5	<b>241265</b>
			70	9	1.050	2.000 - 2.200	24	2.200	5	<b>241266</b>
			70	9	1.050	2.000 - 2.200	24	2.200	5	<b>241267</b>
			80	9	1.050	2.000 - 2.200	24	2.200	5	<b>241268</b>

241394

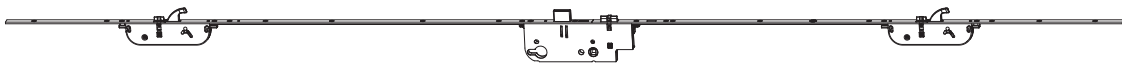









**2.2.30 Door lock Z-TA Automatic PT-M with 2 MF-HO E94 F-24 K+605**



modular	silver	94	35	9	1.050	1.800 - 2.000	24	2.000	5	<b>№</b>
			40	9	1.050	1.800 - 2.000	24	2.000	5	<b>241390</b>
			45	9	1.050	1.800 - 2.000	24	2.000	5	<b>241391</b>
			50	9	1.050	1.800 - 2.000	24	2.000	5	<b>241392</b>
			55	9	1.050	1.800 - 2.000	24	2.000	5	<b>241393</b>
			60	9	1.050	1.800 - 2.000	24	2.000	5	<b>241394</b>
			65	9	1.050	1.800 - 2.000	24	2.000	5	<b>241395</b>
			70	9	1.050	1.800 - 2.000	24	2.000	5	<b>241396</b>
			70	9	1.050	1.800 - 2.000	24	2.000	5	<b>241397</b>
			80	9	1.050	1.800 - 2.000	24	2.000	5	<b>241398</b>

241524









<b>2.2.31 Door lock Z-TA Automatic PT-M with 2 MF-HO E94 F-24 K+980</b>								<b>L</b>		<b>No</b>
modular	silver	94	35	9	1.050	2.200 - 2.400	24	2.400	5	<b>241520</b>
			40	9	1.050	2.200 - 2.400	24	2.400	5	<b>241521</b>
			45	9	1.050	2.200 - 2.400	24	2.400	5	<b>241522</b>
			50	9	1.050	2.200 - 2.400	24	2.400	5	<b>241523</b>
			55	9	1.050	2.200 - 2.400	24	2.400	5	<b>241524</b>
			60	9	1.050	2.200 - 2.400	24	2.400	5	<b>241525</b>
			65	9	1.050	2.000 - 2.400	24	2.400	5	<b>241526</b>
			70	9	1.050	2.000 - 2.400	24	2.400	5	<b>241527</b>
			80	9	1.050	2.200 - 2.400	24	2.400	5	<b>241528</b>

### Top hat faceplate 24/16 mm







241294

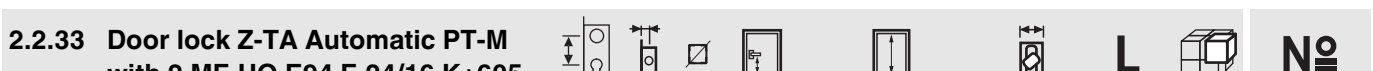

<b>2.2.32 Door lock Z-TA Automatic PT-M with 2 MF-HO E94 F-24/16 top-hat faceplate</b>								<b>L</b>		<b>No</b>
modular	silver	94	35	9	1.050	2.000 - 2.200	24/16	2.200	5	<b>241290</b>
			40	9	1.050	2.000 - 2.200	24/16	2.200	5	<b>241291</b>
			45	9	1.050	2.000 - 2.200	24/16	2.200	5	<b>241292</b>
			50	9	1.050	2.000 - 2.200	24/16	2.200	5	<b>241293</b>
			55	9	1.050	2.000 - 2.200	24/16	2.200	5	<b>241294</b>
			60	9	1.050	2.000 - 2.200	24/16	2.200	5	<b>241295</b>
			65	9	1.050	2.000 - 2.200	24/16	2.200	5	<b>241296</b>
			70	9	1.050	2.000 - 2.200	24/16	2.200	5	<b>241297</b>
			80	9	1.050	2.000 - 2.200	24/16	2.200	5	<b>241298</b>

241424



<b>2.2.33 Door lock Z-TA Automatic PT-M with 2 MF-HO E94 F-24/16 K+605</b>								<b>L</b>		<b>No</b>
modular	silver	94	35	9	1.050	1.800 - 2.000	24/16	2.000	5	<b>241420</b>
			40	9	1.050	1.800 - 2.000	24/16	2.000	5	<b>241421</b>
			45	9	1.050	1.800 - 2.000	24/16	2.000	5	<b>241422</b>
			50	9	1.050	1.800 - 2.000	24/16	2.000	5	<b>241423</b>
			55	9	1.050	1.800 - 2.000	24/16	2.000	5	<b>241424</b>
			60	9	1.050	1.800 - 2.000	24/16	2.000	5	<b>241425</b>
			65	9	1.050	1.800 - 2.000	24/16	2.000	5	<b>241426</b>
			70	9	1.050	1.800 - 2.000	24/16	2.000	5	<b>241427</b>
			80	9	1.050	1.800 - 2.000	24/16	2.000	5	<b>241428</b>

241554



**2.2.34 Door lock Z-TA Automatic PT-M with 2 MF-HO E94 F-24/16 K+980**



**No**

modular	silver	94	35	9	1.050	2.200 - 2.400	24/16	2.400	5	<b>241550</b>
			40	9	1.050	2.200 - 2.400	24/16	2.400	5	<b>241551</b>
			45	9	1.050	2.200 - 2.400	24/16	2.400	5	<b>241552</b>
			50	9	1.050	2.200 - 2.400	24/16	2.400	5	<b>241553</b>
			55	9	1.050	2.200 - 2.400	24/16	2.400	5	<b>241554</b>
			60	9	1.050	2.200 - 2.400	24/16	2.400	5	<b>241555</b>
			65	9	1.050	2.200 - 2.400	24/16	2.400	5	<b>241556</b>
			70	9	1.050	2.200 - 2.400	24/16	2.400	5	<b>241557</b>
			80	9	1.050	2.200 - 2.400	24/16	2.400	5	<b>241558</b>

**U-faceplate 6x24x6 mm**

241584

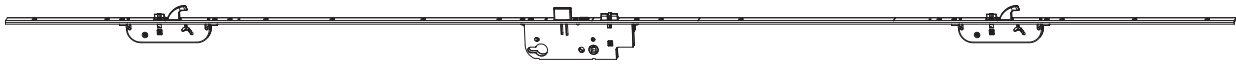

**2.2.35 Door lock Z-TA Automatic PT-M with 2 MF-HO E94 U-6x24x6**



**No**

modular	silver	94	35	9	1.050	2.000 - 2.200	24	2.200	5	<b>241580</b>
			40	9	1.050	2.000 - 2.200	24	2.200	5	<b>241581</b>
			45	9	1.050	2.000 - 2.200	24	2.200	5	<b>241582</b>
			50	9	1.050	2.000 - 2.200	24	2.200	5	<b>241583</b>
			55	9	1.050	2.000 - 2.200	24	2.200	5	<b>241584</b>

241614

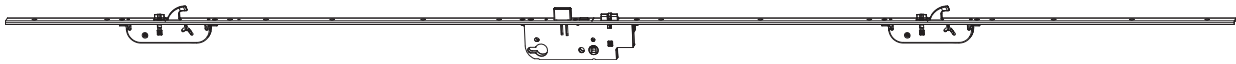

**2.2.36 Door lock Z-TA Automatic PT-M with 2 MF-HO E94 U-6x24x6 K+605**



**No**

modular	silver	94	35	9	1.050	1.800 - 2.000	24	2.200	5	<b>241610</b>
			40	9	1.050	1.800 - 2.000	24	2.200	5	<b>241611</b>
			45	9	1.050	1.800 - 2.000	24	2.200	5	<b>241612</b>
			50	9	1.050	1.800 - 2.000	24	2.200	5	<b>241613</b>
			55	9	1.050	1.800 - 2.000	24	2.200	5	<b>241614</b>

241644



**2.2.37 Door lock Z-TA Automatic PT-M with 2 MF-HO E94 U-6x24x6 K+980**



**No**

modular	silver	94	35	9	1.050	2.200 - 2.400	24	2.200	5	<b>241640</b>
			40	9	1.050	2.200 - 2.400	24	2.200	5	<b>241641</b>
			45	9	1.050	2.200 - 2.400	24	2.200	5	<b>241642</b>
			50	9	1.050	2.200 - 2.400	24	2.200	5	<b>241643</b>
			55	9	1.050	2.200 - 2.400	24	2.200	5	<b>241644</b>

**MACO  
PROTECT**



## Z-TA – Automatic Door Lock Triple Latch



### 3 Z-TF Triple Latch Door Lock

---

<b>3.1</b>	<b>Hardware overview Z-TF</b>	<b>34</b>
3.1.1	Z-TF i.S. PT	34
3.1.2	Z-TF i.S. PT RC2	37
3.1.3	Z-TF MF-BO PT	41
<b>3.2</b>	<b>Door lock Z-TF with MF + i.S.</b>	<b>44</b>
3.2.1	Door lock Z-TF with 2 MF + 2 i.S.	44
3.2.2	Door lock Z-TF PT with 2 MF + 4i.S.	52
<b>3.3</b>	<b>Door lock Z-TF PT with MF-BO</b>	<b>57</b>
3.3.1	Door lock Z-TF PT with 2 MF-BO	57

### 3 Z-TF Triple Latch Door Lock

#### 3.1 Hardware overview Z-TF

##### 3.1.1 Z-TF i.S. PT



2 MF + 2 i.S.

1- & 2-sashed

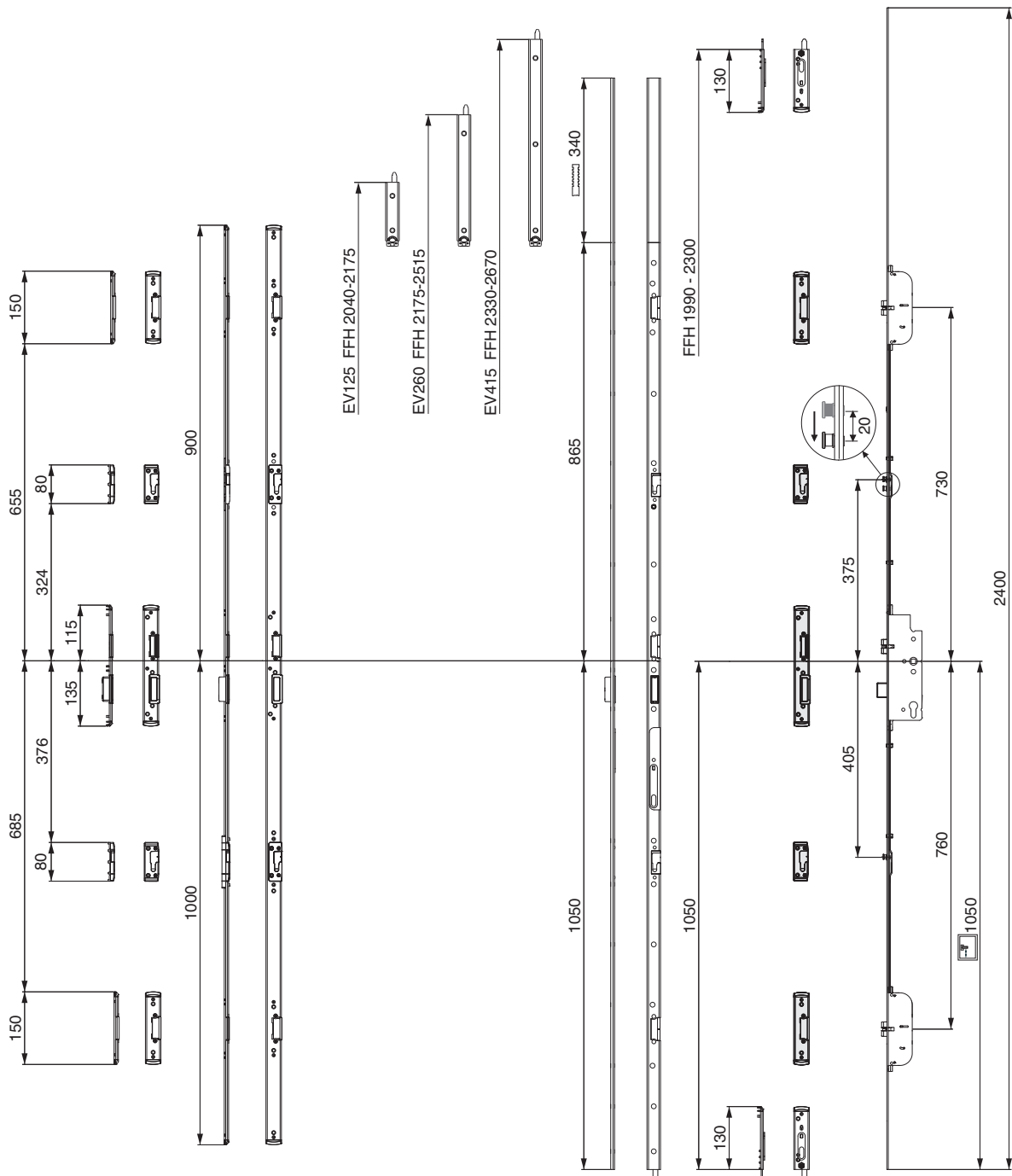



2 MF + 2 i.S. K+500

1- & 2-sashed

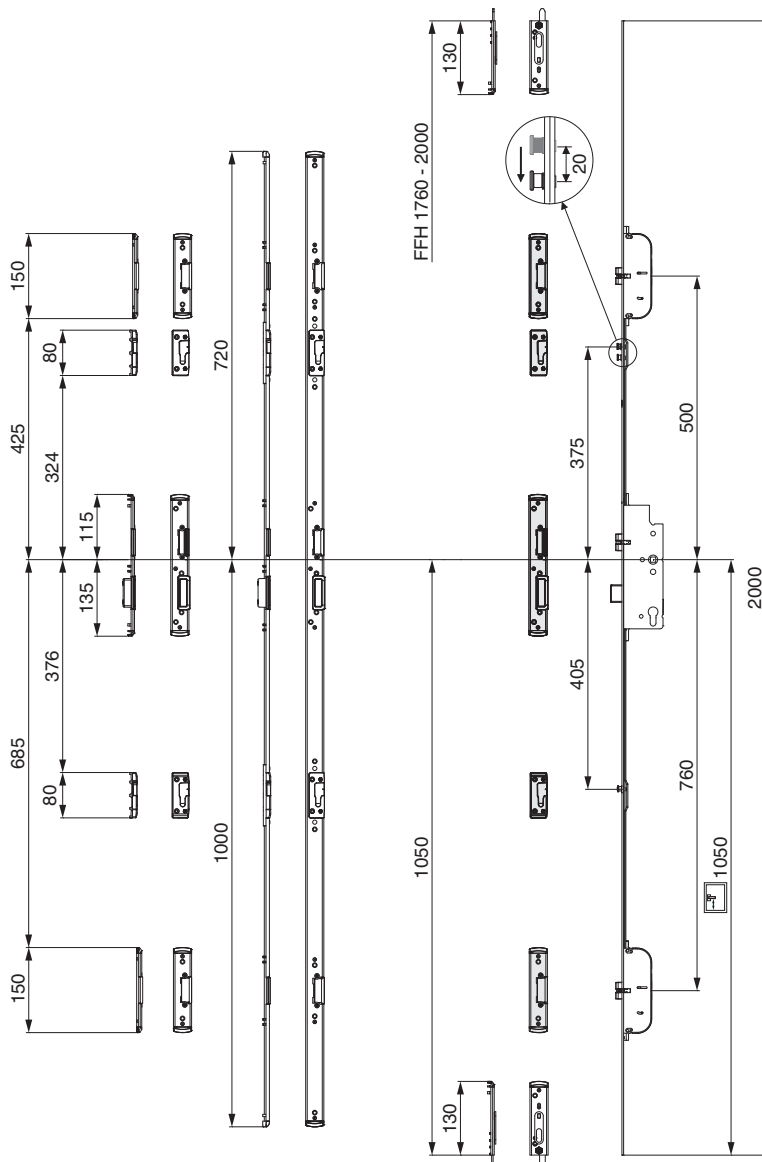



2 MF + 3 i.S. K+1030

1- & 2-sashed

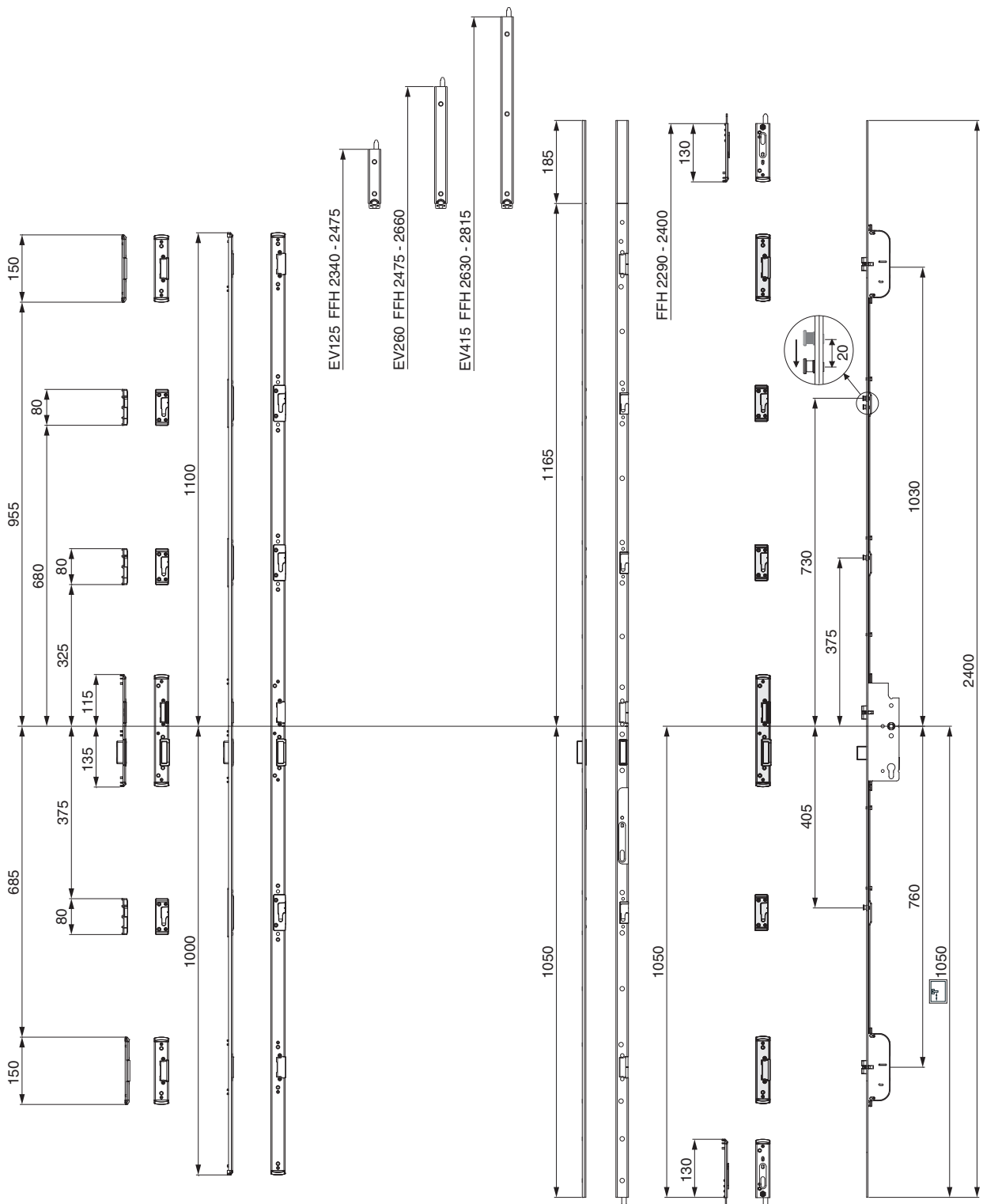

3.1.2 Z-TF i.S. PT RC2



2 MF + 4 i.S.

with end piece 300 mm\*

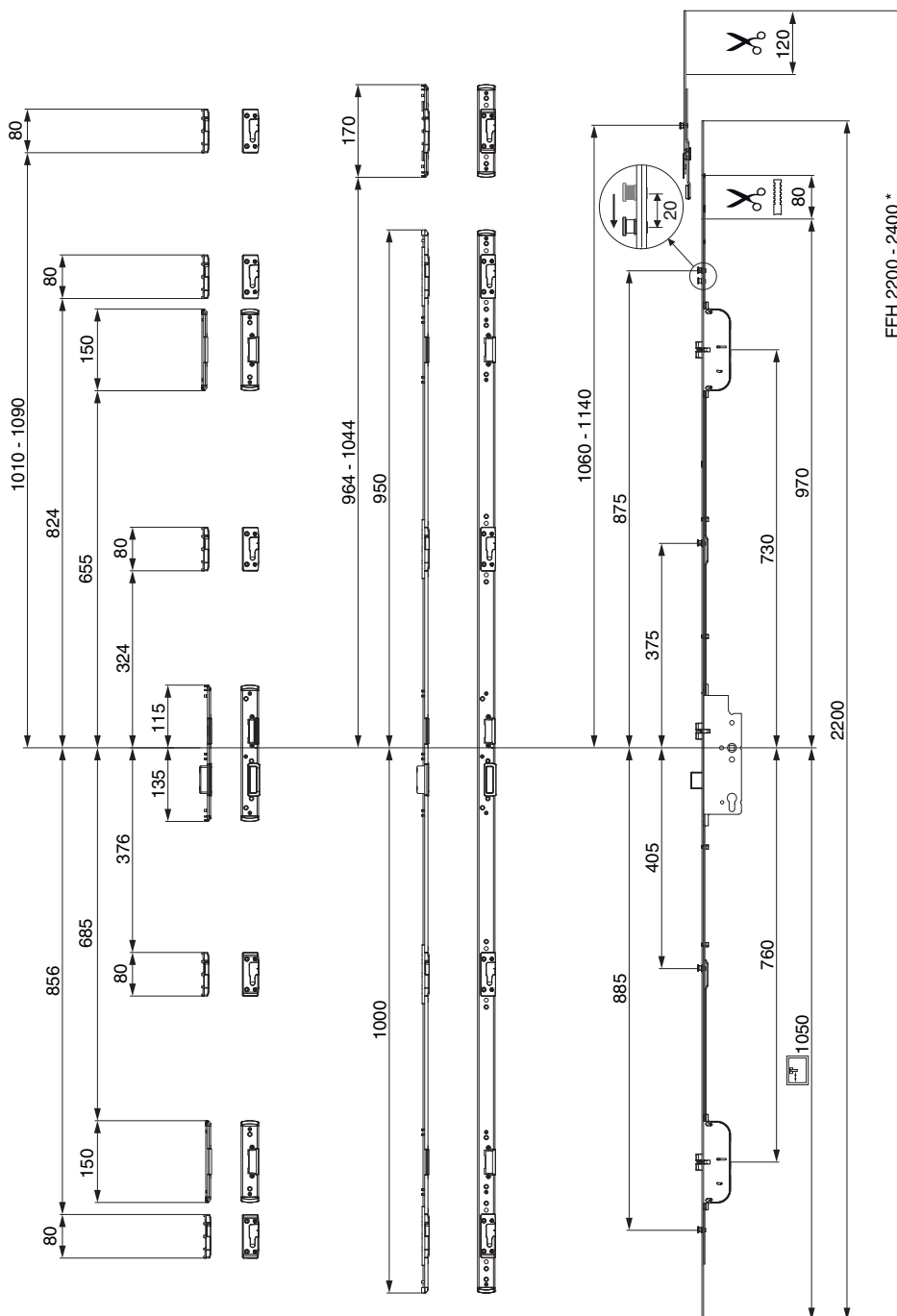



2 MF + 4 i.S.

with end piece 500 mm\*

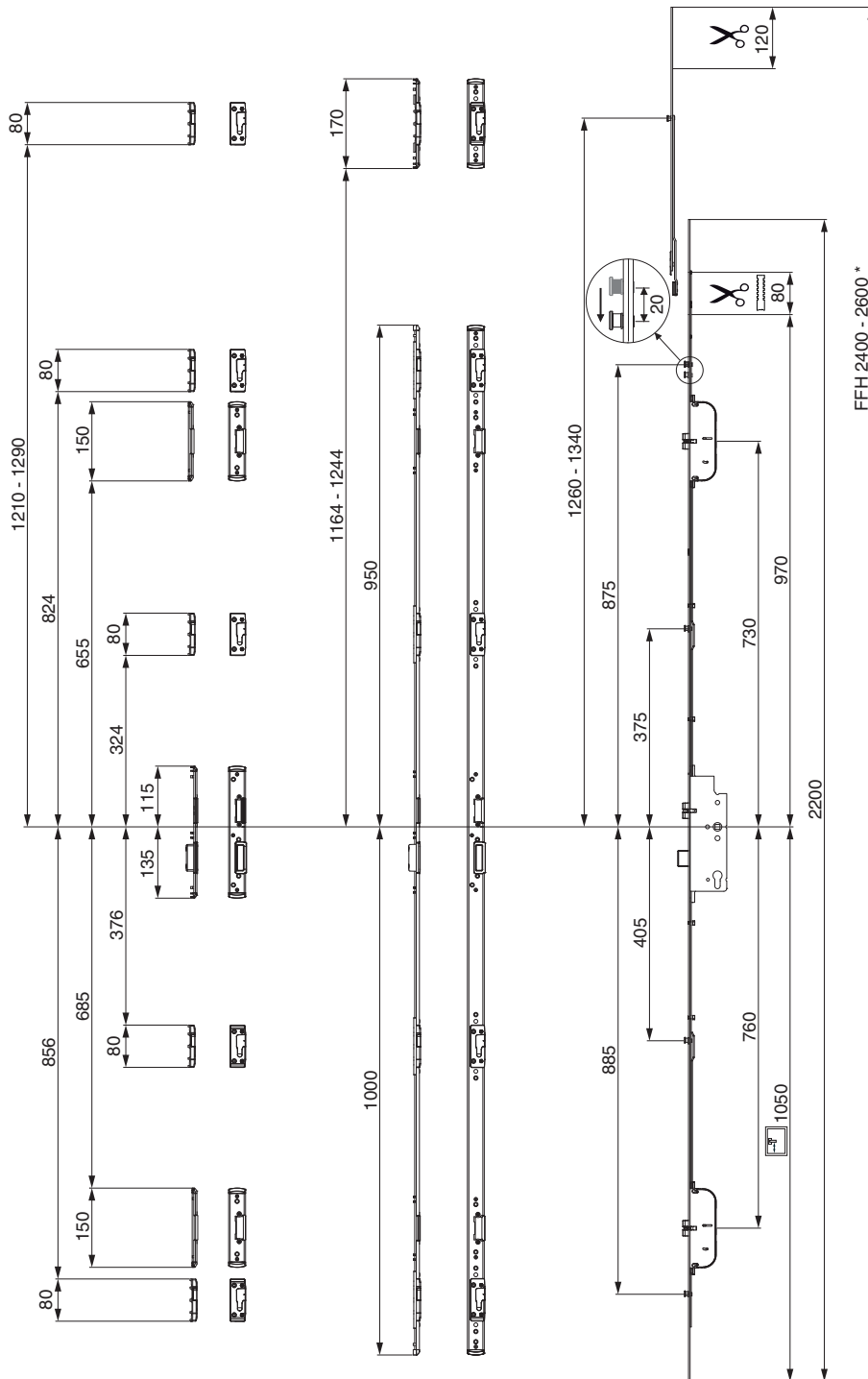



2 MF + 4 i.S. K+500

with end piece 300 mm\*

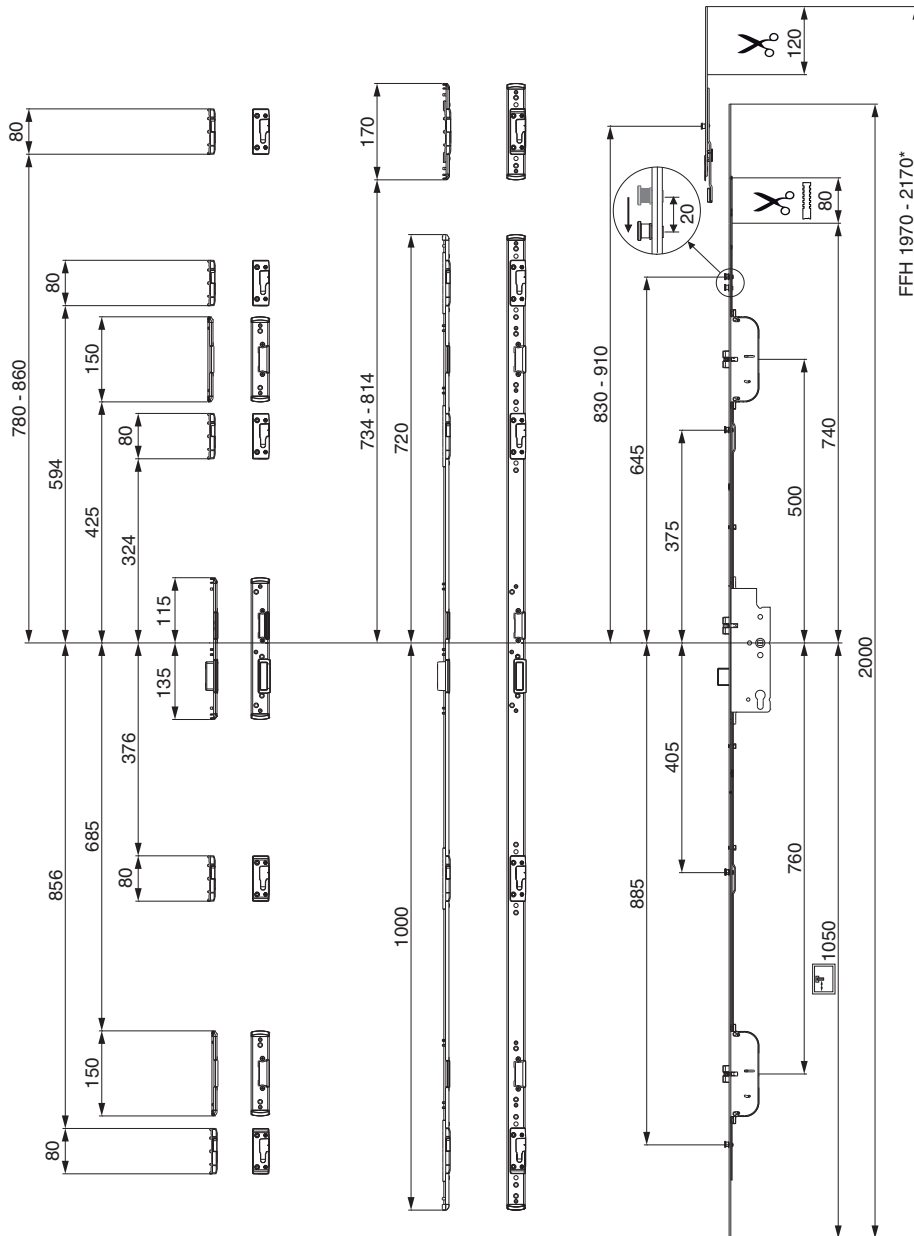





3.1.3 Z-TF MF-BO PT



2 MF-BO  
1- & 2-sashed

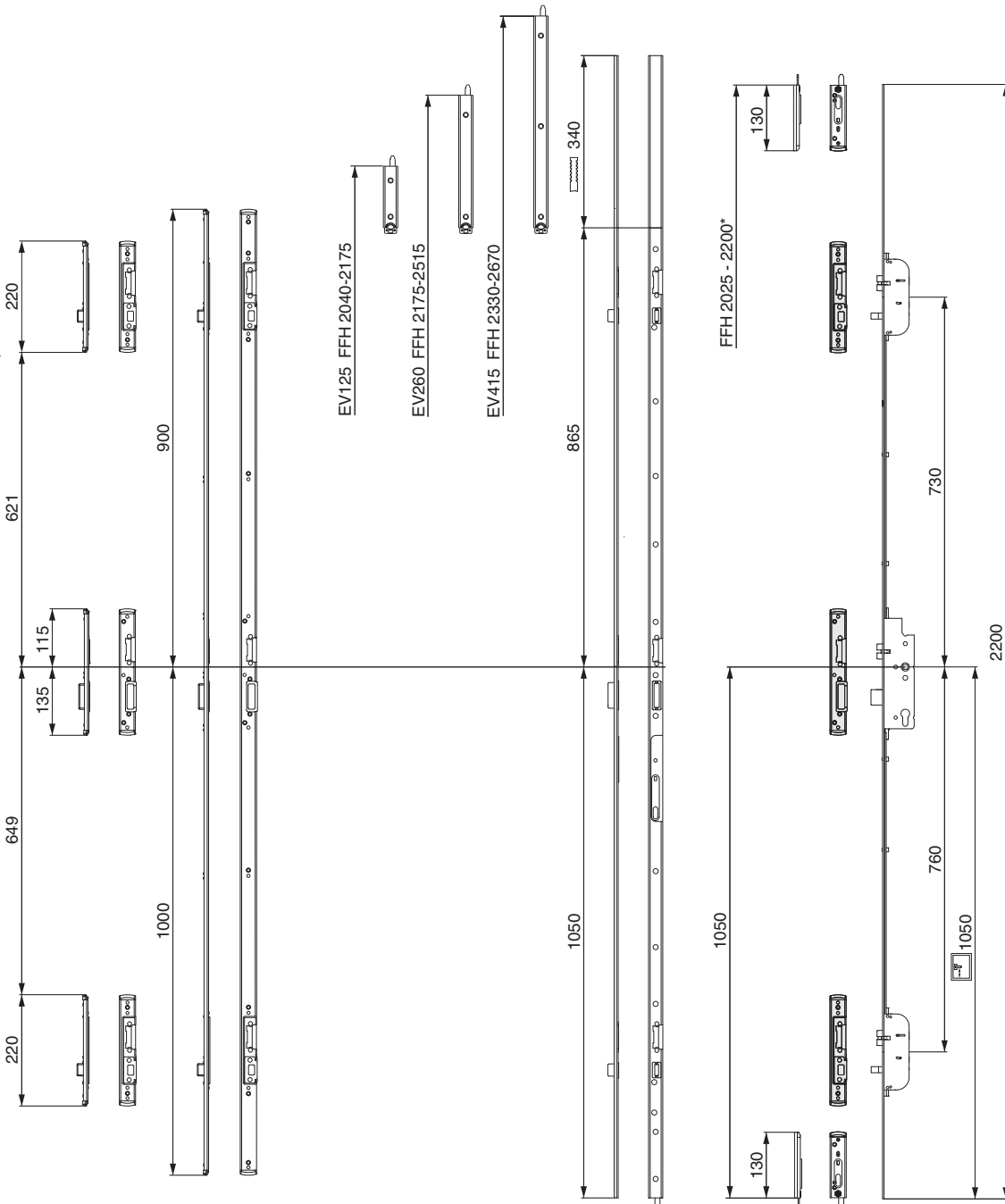



2 MF-BO K+605

1- & 2-sashed

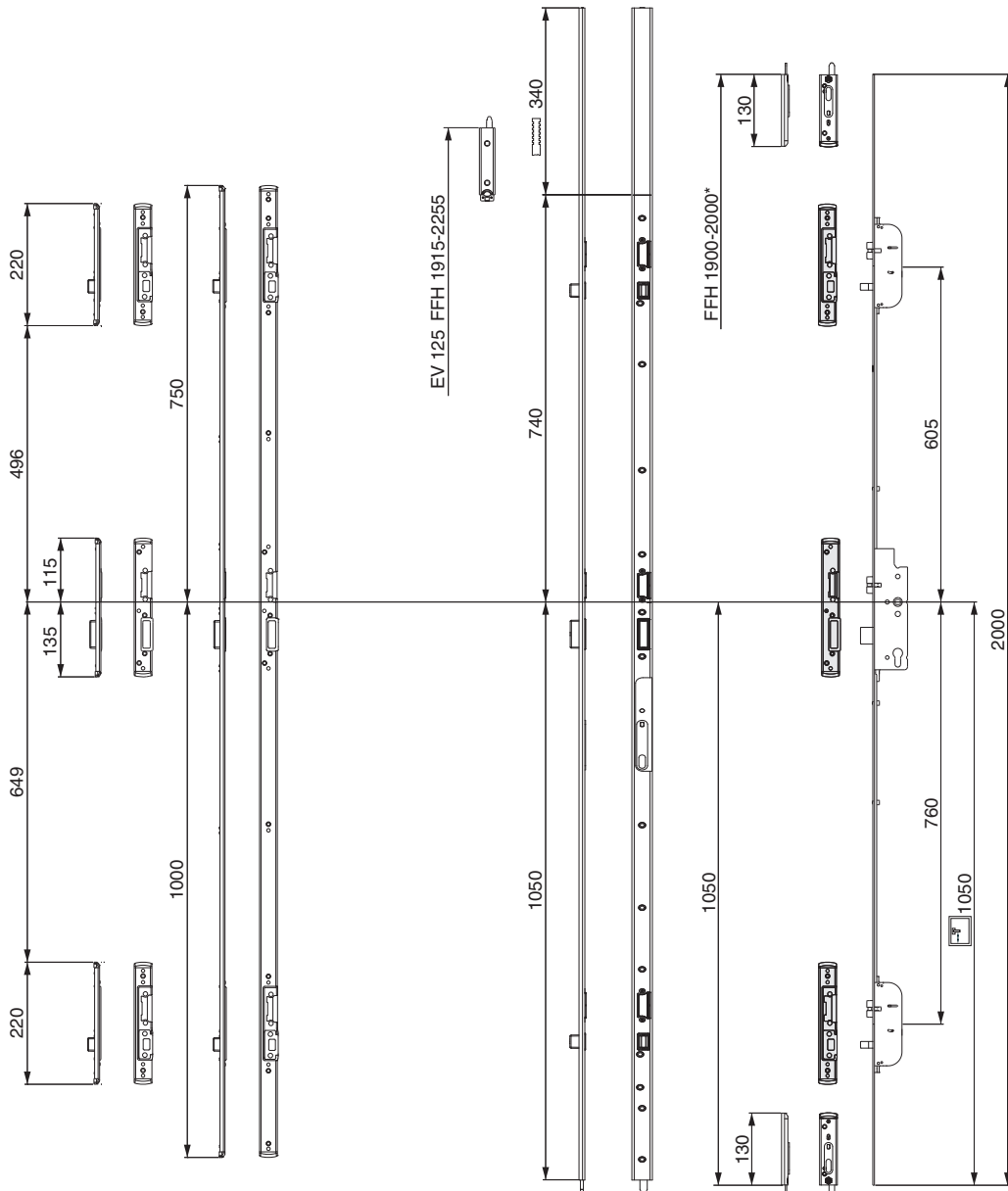



2 MF-BO K+980

1- & 2-sashed

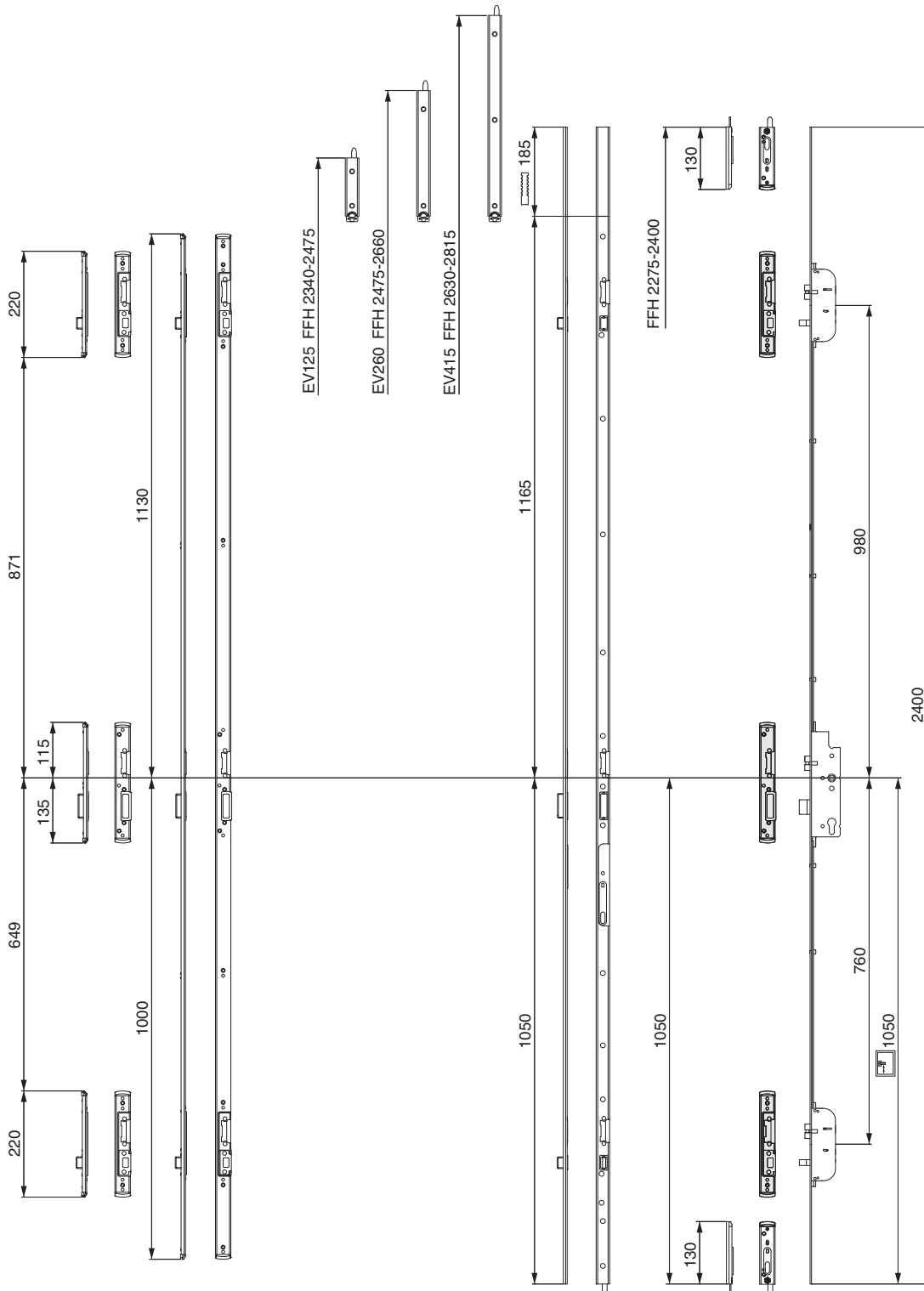

### 3.2 Door lock Z-TF with MF + i.S.







#### 3.2.1 Door lock Z-TF with 2 MF + 2 i.S.

Flat faceplate 16 mm

235774









##### 3.2.1.1 Door lock Z-TF PT with 2 MF + 2i.S. E92 F-16

								<b>L</b>		<b>No</b>
fixed handle height	silver	92	35	8	1.050	1.950 - 2.400	16	2.400	5	<b>235770</b>
				10	1.050	1.950 - 2.400	16	2.400	5	<b>235780</b>
				40	1.050	1.950 - 2.400	16	2.400	5	<b>235771</b>
				10	1.050	1.950 - 2.400	16	2.400	5	<b>235781</b>
				45	1.050	1.950 - 2.400	16	2.400	5	<b>235772</b>
				10	1.050	1.950 - 2.400	16	2.400	5	<b>235782</b>
				50	1.050	1.950 - 2.400	16	2.400	5	<b>235773</b>
				10	1.050	1.950 - 2.400	16	2.400	5	<b>235783</b>
				55	1.050	1.950 - 2.400	16	2.400	5	<b>235774</b>
				10	1.050	1.950 - 2.400	16	2.400	5	<b>235784</b>
				65	1.050	1.950 - 2.400	16	2.400	5	<b>235775</b>
				10	1.050	1.950 - 2.400	16	2.400	5	<b>235785</b>
				70	1.050	1.950 - 2.400	16	2.400	5	<b>235776</b>
				10	1.050	1.950 - 2.400	16	2.400	5	<b>235786</b>
				80	1.050	1.950 - 2.400	16	2.400	5	<b>235777</b>
				10	1.050	1.950 - 2.400	16	2.400	5	<b>235787</b>

237854



##### 3.2.1.2 Door lock Z-TF PT with 2 MF + 2i.S. E92 F-16 K+500

								<b>L</b>		<b>No</b>
fixed handle height	silver	92	35	8	1.050	1.700 - 2.000	16	2.000	5	<b>237850</b>
				10	1.050	1.700 - 2.000	16	2.000	5	<b>237870</b>
				40	1.050	1.700 - 2.000	16	2.000	5	<b>237851</b>
				10	1.050	1.700 - 2.000	16	2.000	5	<b>237871</b>
				45	1.050	1.700 - 2.000	16	2.000	5	<b>237852</b>
				10	1.050	1.700 - 2.000	16	2.000	5	<b>237872</b>
				50	1.050	1.700 - 2.000	16	2.000	5	<b>237853</b>
				10	1.050	1.700 - 2.000	16	2.000	5	<b>237873</b>
				55	1.050	1.700 - 2.000	16	2.000	5	<b>237854</b>
				10	1.050	1.700 - 2.000	16	2.000	5	<b>237874</b>
				65	1.050	1.700 - 2.000	16	2.000	5	<b>237855</b>
				10	1.050	1.700 - 2.000	16	2.000	5	<b>237875</b>
				70	1.050	1.700 - 2.000	16	2.000	5	<b>237856</b>
				10	1.050	1.700 - 2.000	16	2.000	5	<b>237876</b>
				80	1.050	1.700 - 2.000	16	2.000	5	<b>237857</b>
				10	1.050	1.700 - 2.000	16	2.000	5	<b>237877</b>

234774



**3.2.1.3 Door lock Z-TF PT  
with 2 MF + 3i.S. E92 F-16 K+1030**



fixed handle height	silver	92	35	8	1.050	2.250 - 2.400	16	2.400	5	No
				10	1.050	2.250 - 2.400	16	2.400	5	<b>234770</b>
			40	8	1.050	2.250 - 2.400	16	2.400	5	<b>234771</b>
				10	1.050	2.250 - 2.400	16	2.400	5	<b>234201</b>
			45	8	1.050	2.250 - 2.400	16	2.400	5	<b>234772</b>
				10	1.050	2.250 - 2.400	16	2.400	5	<b>234202</b>
			50	8	1.050	2.250 - 2.400	16	2.400	5	<b>234773</b>
				10	1.050	2.250 - 2.400	16	2.400	5	<b>234203</b>
			55	8	1.050	2.250 - 2.400	16	2.400	5	<b>234774</b>
				10	1.050	2.250 - 2.400	16	2.400	5	<b>234204</b>
			65	8	1.050	2.250 - 2.400	16	2.400	5	<b>234775</b>
				10	1.050	2.250 - 2.400	16	2.400	5	<b>234205</b>
			70	8	1.050	2.250 - 2.400	16	2.400	5	<b>234776</b>
				10	1.050	2.250 - 2.400	16	2.400	5	<b>234206</b>
			80	8	1.050	2.250 - 2.400	16	2.400	5	<b>234777</b>
				10	1.050	2.250 - 2.400	16	2.400	5	<b>234207</b>

**Flat faceplate 20 mm**

235344



**3.2.1.4 Door lock Z-TF PT  
with 2 MF + 2i.S. E92 F-20**



fixed handle height	silver	92	35	8	1.050	1.950 - 2.400	20	2.400	5	No
				10	1.050	1.950 - 2.400	20	2.400	5	<b>235340</b>
			40	8	1.050	1.950 - 2.400	20	2.400	5	<b>235341</b>
				10	1.050	1.950 - 2.400	20	2.400	5	<b>235351</b>
			45	8	1.050	1.950 - 2.400	20	2.400	5	<b>235342</b>
				10	1.050	1.950 - 2.400	20	2.400	5	<b>235352</b>
			50	8	1.050	1.950 - 2.400	20	2.400	5	<b>235343</b>
				10	1.050	1.950 - 2.400	20	2.400	5	<b>235353</b>
			55	8	1.050	1.950 - 2.400	20	2.400	5	<b>235344</b>
				10	1.050	1.950 - 2.400	20	2.400	5	<b>235354</b>
			65	8	1.050	1.950 - 2.400	20	2.400	5	<b>235345</b>
				10	1.050	1.950 - 2.400	20	2.400	5	<b>235355</b>
			70	8	1.050	1.950 - 2.400	20	2.400	5	<b>235346</b>
				10	1.050	1.950 - 2.400	20	2.400	5	<b>235356</b>
			80	8	1.050	1.950 - 2.400	20	2.400	5	<b>235347</b>
				10	1.050	1.950 - 2.400	20	2.400	5	<b>235357</b>

3

238034



<b>3.2.1.5 Door lock Z-TF PT with 2 MF + 2i.S. E92 F-20 K+500</b>								<b>L</b>		<b>No</b>
fixed handle height	silver	92	35	8	1.050	1.700 - 2.000	20	2.000	5	<b>238030</b>
				10	1.050	1.700 - 2.000	20	2.000	5	<b>238050</b>
			40	8	1.050	1.700 - 2.000	20	2.000	5	<b>238031</b>
				10	1.050	1.700 - 2.000	20	2.000	5	<b>238051</b>
			45	8	1.050	1.700 - 2.000	20	2.000	5	<b>238032</b>
				10	1.050	1.700 - 2.000	20	2.000	5	<b>238052</b>
			50	8	1.050	1.700 - 2.000	20	2.000	5	<b>238033</b>
				10	1.050	1.700 - 2.000	20	2.000	5	<b>238053</b>
			55	8	1.050	1.700 - 2.000	20	2.000	5	<b>238034</b>
				10	1.050	1.700 - 2.000	20	2.000	5	<b>238054</b>
			65	8	1.050	1.700 - 2.000	20	2.000	5	<b>238035</b>
				10	1.050	1.700 - 2.000	20	2.000	5	<b>238055</b>
			70	8	1.050	1.700 - 2.000	20	2.000	5	<b>238036</b>
				10	1.050	1.700 - 2.000	20	2.000	5	<b>238056</b>
			80	8	1.050	1.700 - 2.000	20	2.000	5	<b>238037</b>
				10	1.050	1.700 - 2.000	20	2.000	5	<b>238057</b>

234794













<b>3.2.1.6 Door lock Z-TF PT with 2 MF + 3i.S. E92 F-20 K+1030</b>								<b>L</b>		<b>No</b>
fixed handle height	silver	92	35	8	1.050	2.250 - 2.400	20	2.400	5	<b>234790</b>
				10	1.050	2.250 - 2.400	20	2.400	5	<b>234230</b>
			40	8	1.050	2.250 - 2.400	20	2.400	5	<b>234791</b>
				10	1.050	2.250 - 2.400	20	2.400	5	<b>234231</b>
			45	8	1.050	2.250 - 2.400	20	2.400	5	<b>234792</b>
				10	1.050	2.250 - 2.400	20	2.400	5	<b>234232</b>
			50	8	1.050	2.250 - 2.400	20	2.400	5	<b>234793</b>
				10	1.050	2.250 - 2.400	20	2.400	5	<b>234233</b>
			55	8	1.050	2.250 - 2.400	20	2.400	5	<b>234794</b>
				10	1.050	2.250 - 2.400	20	2.400	5	<b>234234</b>
			65	8	1.050	2.250 - 2.400	20	2.400	5	<b>234795</b>
				10	1.050	2.250 - 2.400	20	2.400	5	<b>234235</b>
			70	8	1.050	2.250 - 2.400	20	2.400	5	<b>234796</b>
				10	1.050	2.250 - 2.400	20	2.400	5	<b>234236</b>
			80	8	1.050	2.250 - 2.400	20	2.400	5	<b>234797</b>
				10	1.050	2.250 - 2.400	20	2.400	5	<b>234237</b>

## Flat faceplate 24 mm

235374



### 3.2.1.7 Door lock Z-TF PT with 2 MF + 2i.S. E92 F-24











											
fixed handle height	silver	92	35	8	1.050	1.950 - 2.400	24	2.400	5		<b>No</b>
				10	1.050	1.950 - 2.400	24	2.400	5		<b>235380</b>
			40	8	1.050	1.950 - 2.400	24	2.400	5		<b>235371</b>
				10	1.050	1.950 - 2.400	24	2.400	5		<b>235381</b>
			45	8	1.050	1.950 - 2.400	24	2.400	5		<b>235372</b>
				10	1.050	1.950 - 2.400	24	2.400	5		<b>235382</b>
			50	8	1.050	1.950 - 2.400	24	2.400	5		<b>235373</b>
				10	1.050	1.950 - 2.400	24	2.400	5		<b>235383</b>
			55	8	1.050	1.950 - 2.400	24	2.400	5		<b>235374</b>
				10	1.050	1.950 - 2.400	24	2.400	5		<b>235384</b>
			65	8	1.050	1.950 - 2.400	24	2.400	5		<b>235375</b>
				10	1.050	1.950 - 2.400	24	2.400	5		<b>235385</b>
			70	8	1.050	1.950 - 2.400	24	2.400	5		<b>235376</b>
				10	1.050	1.950 - 2.400	24	2.400	5		<b>235386</b>
			80	8	1.050	1.950 - 2.400	24	2.400	5		<b>235377</b>
				10	1.050	1.950 - 2.400	24	2.400	5		<b>235387</b>

## Top hat faceplate 24/16 mm

237654









### 3.2.1.8 Door lock Z-TF PT with 2 MF + 2i.S. E92 F-24/16

											
fixed handle height	silver	92	35	8	1.050	1.950 - 2.400	24/16	2.400	5		<b>No</b>
				10	1.050	1.950 - 2.400	24/16	2.400	5		<b>237660</b>
			40	8	1.050	1.950 - 2.400	24/16	2.400	5		<b>237651</b>
				10	1.050	1.950 - 2.400	24/16	2.400	5		<b>237661</b>
			45	8	1.050	1.950 - 2.400	24/16	2.400	5		<b>237652</b>
				10	1.050	1.950 - 2.400	24/16	2.400	5		<b>237662</b>
			50	8	1.050	1.950 - 2.400	24/16	2.400	5		<b>237653</b>
				10	1.050	1.950 - 2.400	24/16	2.400	5		<b>237663</b>
			55	8	1.050	1.950 - 2.400	24/16	2.400	5		<b>237654</b>
				10	1.050	1.950 - 2.400	24/16	2.400	5		<b>237664</b>
			65	8	1.050	1.950 - 2.400	24/16	2.400	5		<b>237655</b>
				10	1.050	1.950 - 2.400	24/16	2.400	5		<b>237665</b>
			70	8	1.050	1.950 - 2.400	24/16	2.400	5		<b>237656</b>
				10	1.050	1.950 - 2.400	24/16	2.400	5		<b>237666</b>
			80	8	1.050	1.950 - 2.400	24/16	2.400	5		<b>237657</b>
				10	1.050	1.950 - 2.400	24/16	2.400	5		<b>237667</b>







238214



<b>3.2.1.9 Door lock Z-TF PT with 2 MF + 2i.S. E92 F-24/16 K+500</b>								<b>L</b>		<b>No</b>
fixed handle height	silver	92	35	8	1.050	1.700 - 2.000	24/16	2.000	5	<b>238210</b>
				10	1.050	1.700 - 2.000	24/16	2.000	5	<b>238230</b>
			40	8	1.050	1.700 - 2.000	24/16	2.000	5	<b>238211</b>
				10	1.050	1.700 - 2.000	24/16	2.000	5	<b>238231</b>
			45	8	1.050	1.700 - 2.000	24/16	2.000	5	<b>238212</b>
				10	1.050	1.700 - 2.000	24/16	2.000	5	<b>238232</b>
			50	8	1.050	1.700 - 2.000	24/16	2.000	5	<b>238213</b>
				10	1.050	1.700 - 2.000	24/16	2.000	5	<b>238233</b>
			55	8	1.050	1.700 - 2.000	24/16	2.000	5	<b>238214</b>
				10	1.050	1.700 - 2.000	24/16	2.000	5	<b>238234</b>
			65	8	1.050	1.700 - 2.000	24/16	2.000	5	<b>238215</b>
				10	1.050	1.700 - 2.000	24/16	2.000	5	<b>238235</b>
			70	8	1.050	1.700 - 2.000	24/16	2.000	5	<b>238216</b>
				10	1.050	1.700 - 2.000	24/16	2.000	5	<b>238236</b>
			80	8	1.050	1.700 - 2.000	24/16	2.000	5	<b>238217</b>
				10	1.050	1.700 - 2.000	24/16	2.000	5	<b>238237</b>

237684



<b>3.2.1.10 Door lock Z-TF PT with 2 MF + 3i.S. E92 F-24/16 K+1030</b>								<b>L</b>		<b>No</b>
fixed handle height	silver	92	35	8	1.050	2.250 - 2.400	24/16	2.400	5	<b>237680</b>
				10	1.050	2.250 - 2.400	24/16	2.400	5	<b>237690</b>
			40	8	1.050	2.250 - 2.400	24/16	2.400	5	<b>237681</b>
				10	1.050	2.250 - 2.400	24/16	2.400	5	<b>237691</b>
			45	8	1.050	2.250 - 2.400	24/16	2.400	5	<b>237682</b>
				10	1.050	2.250 - 2.400	24/16	2.400	5	<b>237692</b>
			50	8	1.050	2.250 - 2.400	24/16	2.400	5	<b>237683</b>
				10	1.050	2.250 - 2.400	24/16	2.400	5	<b>237693</b>
			55	8	1.050	2.250 - 2.400	24/16	2.400	5	<b>237684</b>
				10	1.050	2.250 - 2.400	24/16	2.400	5	<b>237694</b>
			65	8	1.050	2.250 - 2.400	24/16	2.400	5	<b>237685</b>
				10	1.050	2.250 - 2.400	24/16	2.400	5	<b>237695</b>
			70	8	1.050	2.250 - 2.400	24/16	2.400	5	<b>237686</b>
				10	1.050	2.250 - 2.400	24/16	2.400	5	<b>237696</b>
			80	8	1.050	2.250 - 2.400	24/16	2.400	5	<b>237687</b>
				10	1.050	2.250 - 2.400	24/16	2.400	5	<b>237697</b>

Flat faceplate 16 mm

234284



**3.2.1.11 Door lock Z-TF PT  
with 2 MF + 2i.S. E94 F-16**



fixed handle height	silver	94	35	9	1.050	1.950 - 2.400	16	2.400	5	<b>No</b>
			40	9	1.050	1.950 - 2.400	16	2.400	5	<b>234280</b>
			45	9	1.050	1.950 - 2.400	16	2.400	5	<b>234281</b>
			50	9	1.050	1.950 - 2.400	16	2.400	5	<b>234282</b>
			55	9	1.050	1.950 - 2.400	16	2.400	5	<b>234283</b>
			65	9	1.050	1.950 - 2.400	16	2.400	5	<b>234284</b>
			70	9	1.050	1.950 - 2.400	16	2.400	5	<b>234285</b>
			80	9	1.050	1.950 - 2.400	16	2.400	5	<b>234286</b>
										<b>234287</b>

237884



**3.2.1.12 Door lock Z-TF PT  
with 2 MF + 2i.S. E94 F-16 K+500**



fixed handle height	silver	94	35	9	1.050	1.700 - 2.000	16	2.000	5	<b>No</b>
			40	9	1.050	1.700 - 2.000	16	2.000	5	<b>237880</b>
			45	9	1.050	1.700 - 2.000	16	2.000	5	<b>237881</b>
			50	9	1.050	1.700 - 2.000	16	2.000	5	<b>237882</b>
			55	9	1.050	1.700 - 2.000	16	2.000	5	<b>237883</b>
			65	9	1.050	1.700 - 2.000	16	2.000	5	<b>237884</b>
			70	9	1.050	1.700 - 2.000	16	2.000	5	<b>237885</b>
			80	9	1.050	1.700 - 2.000	16	2.000	5	<b>237886</b>
										<b>237887</b>

234224



**3.2.1.13 Door lock Z-TF PT  
with 2 MF + 3i.S. E94 F-16 K+1030**









fixed handle height	silver	94	35	9	1.050	2.250 - 2.400	16	2.400	5	<b>No</b>
			40	9	1.050	2.250 - 2.400	16	2.400	5	<b>234220</b>
			45	9	1.050	2.250 - 2.400	16	2.400	5	<b>234221</b>
			50	9	1.050	2.250 - 2.400	16	2.400	5	<b>234222</b>
			55	9	1.050	2.250 - 2.400	16	2.400	5	<b>234223</b>
			65	9	1.050	2.250 - 2.400	16	2.400	5	<b>234224</b>
			70	9	1.050	2.250 - 2.400	16	2.400	5	<b>234225</b>
			80	9	1.050	2.250 - 2.400	16	2.400	5	<b>234226</b>
										<b>234227</b>

Flat faceplate 20 mm

234634









**3.2.1.14 Door lock Z-TF PT  
with 2 MF + 2i.S. E94 F-20**

								L		No
fixed handle height	silver	94	35	9	1.050	1.950 - 2.400	20	2.400	5	<b>234630</b>
			40	9	1.050	1.950 - 2.400	20	2.400	5	<b>234631</b>
			45	9	1.050	1.950 - 2.400	20	2.400	5	<b>234632</b>
			50	9	1.050	1.950 - 2.400	20	2.400	5	<b>234633</b>
			55	9	1.050	1.950 - 2.400	20	2.400	5	<b>234634</b>
			65	9	1.050	1.950 - 2.400	20	2.400	5	<b>234635</b>
			70	9	1.050	1.950 - 2.400	20	2.400	5	<b>234636</b>
			80	9	1.050	1.950 - 2.400	20	2.400	5	<b>234637</b>

238064









**3.2.1.15 Door lock Z-TF PT  
with 2 MF + 2i.S. E94 F-20 K+500**

								L		No
fixed handle height	silver	94	35	9	1.050	1.700 - 2.000	20	2.000	5	<b>238060</b>
			40	9	1.050	1.700 - 2.000	20	2.000	5	<b>238061</b>
			45	9	1.050	1.700 - 2.000	20	2.000	5	<b>238062</b>
			50	9	1.050	1.700 - 2.000	20	2.000	5	<b>238063</b>
			55	9	1.050	1.700 - 2.000	20	2.000	5	<b>238064</b>
			65	9	1.050	1.700 - 2.000	20	2.000	5	<b>238065</b>
			70	9	1.050	1.700 - 2.000	20	2.000	5	<b>238066</b>
			80	9	1.050	1.700 - 2.000	20	2.000	5	<b>238067</b>

234254



**3.2.1.16 Door lock Z-TF PT  
with 2 MF + 3i.S. E94 F-20 K+1030**

								L		No
fixed handle height	silver	94	35	9	1.050	2.250 - 2.400	20	2.400	5	<b>234250</b>
			40	9	1.050	2.250 - 2.400	20	2.400	5	<b>234251</b>
			45	9	1.050	2.250 - 2.400	20	2.400	5	<b>234252</b>
			50	9	1.050	2.250 - 2.400	20	2.400	5	<b>234253</b>
			55	9	1.050	2.250 - 2.400	20	2.400	5	<b>234254</b>
			65	9	1.050	2.250 - 2.400	20	2.400	5	<b>234255</b>
			70	9	1.050	2.250 - 2.400	20	2.400	5	<b>234256</b>
			80	9	1.050	2.250 - 2.400	20	2.400	5	<b>234257</b>

Top hat faceplate 24/16 mm

238374



**3.2.1.17 Door lock Z-TF PT  
with 2 MF + 2i.S. E94 F-24/16**



fixed handle height	silver	94	35	9	1.050	1.950 - 2.400	24/16	2.400	5	<b>No</b>
			40	9	1.050	1.950 - 2.400	24/16	2.400	5	<b>238370</b>
			45	9	1.050	1.950 - 2.400	24/16	2.400	5	<b>238371</b>
			50	9	1.050	1.950 - 2.400	24/16	2.400	5	<b>238372</b>
			55	9	1.050	1.950 - 2.400	24/16	2.400	5	<b>238373</b>
			65	9	1.050	1.950 - 2.400	24/16	2.400	5	<b>238374</b>
			70	9	1.050	1.950 - 2.400	24/16	2.400	5	<b>238375</b>
			80	9	1.050	1.950 - 2.400	24/16	2.400	5	<b>238376</b>
										<b>238377</b>

238244



**3.2.1.18 Door lock Z-TF PT  
with 2 MF + 2i.S. E94 F-24/16 K+500**



fixed handle height	silver	94	35	9	1.050	1.700 - 2.000	24/16	2.000	5	<b>No</b>
			40	9	1.050	1.700 - 2.000	24/16	2.000	5	<b>238240</b>
			45	9	1.050	1.700 - 2.000	24/16	2.000	5	<b>238241</b>
			50	9	1.050	1.700 - 2.000	24/16	2.000	5	<b>238242</b>
			55	9	1.050	1.700 - 2.000	24/16	2.000	5	<b>238243</b>
			65	9	1.050	1.700 - 2.000	24/16	2.000	5	<b>238244</b>
			70	9	1.050	1.700 - 2.000	24/16	2.000	5	<b>238245</b>
			80	9	1.050	1.700 - 2.000	24/16	2.000	5	<b>238246</b>
										<b>238247</b>

238424



**3.2.1.19 Door lock Z-TF PT  
with 2 MF + 3i.S. E94 F-24/16 K+1030**







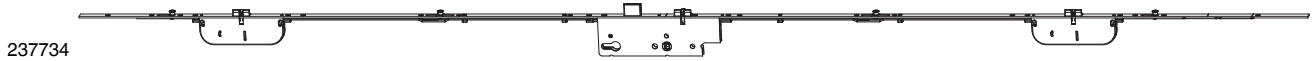

fixed handle height	silver	94	35	9	1.050	2.250 - 2.400	24/16	2.400	5	<b>No</b>
			40	9	1.050	2.250 - 2.400	24/16	2.400	5	<b>238420</b>
			45	9	1.050	2.250 - 2.400	24/16	2.400	5	<b>238421</b>
			50	9	1.050	2.250 - 2.400	24/16	2.400	5	<b>238422</b>
			55	9	1.050	2.250 - 2.400	24/16	2.400	5	<b>238423</b>
			65	9	1.050	2.250 - 2.400	24/16	2.400	5	<b>238424</b>
			70	9	1.050	2.250 - 2.400	24/16	2.400	5	<b>238425</b>
			80	9	1.050	2.250 - 2.400	24/16	2.400	5	<b>238426</b>
										<b>238427</b>

**3.2.2 Door lock Z-TF PT with 2 MF + 4i.S.**

Flat faceplate 16 mm







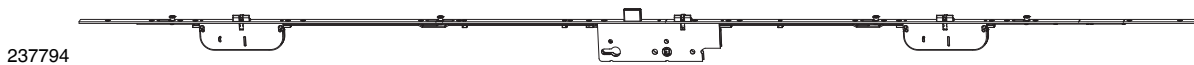

**3.2.2.1 Door lock Z-TF PT with 2 MF + 4i.S. E92 F-16**

								<b>L</b>		<b>No</b>
extendable	silver	92	35	8	1.050	2.000 - 2.200	16	2.200	5	<b>237730</b>
				10	1.050	2.000 - 2.200	16	2.200	5	<b>237750</b>
			40	8	1.050	2.000 - 2.200	16	2.200	5	<b>237731</b>
				10	1.050	2.000 - 2.200	16	2.200	5	<b>237751</b>
			45	8	1.050	2.000 - 2.200	16	2.200	5	<b>237732</b>
				10	1.050	2.000 - 2.200	16	2.200	5	<b>237752</b>
			50	8	1.050	2.000 - 2.200	16	2.200	5	<b>237733</b>
				10	1.050	2.000 - 2.200	16	2.200	5	<b>237753</b>
			55	8	1.050	2.000 - 2.200	16	2.200	5	<b>237734</b>
				10	1.050	2.000 - 2.200	16	2.200	5	<b>237754</b>
			65	8	1.050	2.000 - 2.200	16	2.200	5	<b>237735</b>
				10	1.050	2.000 - 2.200	16	2.200	5	<b>237755</b>
			70	8	1.050	2.000 - 2.200	16	2.200	5	<b>237736</b>
				10	1.050	2.000 - 2.200	16	2.200	5	<b>237756</b>
			80	8	1.050	2.000 - 2.200	16	2.200	5	<b>237737</b>
				10	1.050	2.000 - 2.200	16	2.200	5	<b>237757</b>







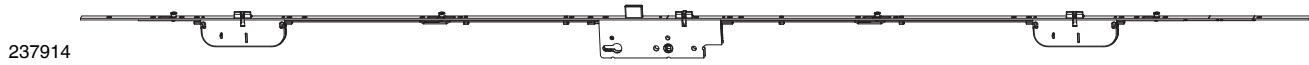

**3.2.2.2 Door lock Z-TF PT with 2 MF + 4i.S. E92 F-16 K+500**

								<b>L</b>		<b>No</b>
extendable	silver	92	35	8	1.050	1.750 - 2.000	16	2.000	5	<b>237790</b>
				10	1.050	1.750 - 2.000	16	2.000	5	<b>237810</b>
			40	8	1.050	1.750 - 2.000	16	2.000	5	<b>237791</b>
				10	1.050	1.750 - 2.000	16	2.000	5	<b>237811</b>
			45	8	1.050	1.750 - 2.000	16	2.000	5	<b>237792</b>
				10	1.050	1.750 - 2.000	16	2.000	5	<b>237812</b>
			50	8	1.050	1.750 - 2.000	16	2.000	5	<b>237793</b>
				10	1.050	1.750 - 2.000	16	2.000	5	<b>237813</b>
			55	8	1.050	1.750 - 2.000	16	2.000	5	<b>237794</b>
				10	1.050	1.750 - 2.000	16	2.000	5	<b>237814</b>
			65	8	1.050	1.750 - 2.000	16	2.000	5	<b>237795</b>
				10	1.050	1.750 - 2.000	16	2.000	5	<b>237815</b>
			70	8	1.050	1.750 - 2.000	16	2.000	5	<b>237796</b>
				10	1.050	1.750 - 2.000	16	2.000	5	<b>237816</b>
			80	8	1.050	1.750 - 2.000	16	2.000	5	<b>237797</b>
				10	1.050	1.750 - 2.000	16	2.000	5	<b>237817</b>

## Flat faceplate 20 mm







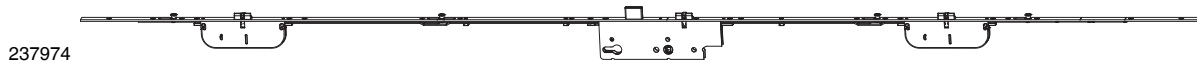

237914

<b>3.2.2.3 Door lock Z-TF PT with 2 MF + 4i.S. E92 F-20</b>								<b>L</b>		<b>No</b>
extendable	silver	92	35	8	1.050	2.000 - 2.200	20	2.200	5	<b>237910</b>
				10	1.050	2.000 - 2.200	20	2.200	5	<b>237930</b>
			40	8	1.050	2.000 - 2.200	20	2.200	5	<b>237911</b>
				10	1.050	2.000 - 2.200	20	2.200	5	<b>237931</b>
			45	8	1.050	2.000 - 2.200	20	2.200	5	<b>237912</b>
				10	1.050	2.000 - 2.200	20	2.200	5	<b>237932</b>
			50	8	1.050	2.000 - 2.200	20	2.200	5	<b>237913</b>
				10	1.050	2.000 - 2.200	20	2.200	5	<b>237933</b>
			55	8	1.050	2.000 - 2.200	20	2.200	5	<b>237914</b>
				10	1.050	2.000 - 2.200	20	2.200	5	<b>237934</b>
			65	8	1.050	2.000 - 2.200	20	2.200	5	<b>237915</b>
				10	1.050	2.000 - 2.200	20	2.200	5	<b>237935</b>
			70	8	1.050	2.000 - 2.200	20	2.200	5	<b>237916</b>
				10	1.050	2.000 - 2.200	20	2.200	5	<b>237936</b>
			80	8	1.050	2.000 - 2.200	20	2.200	5	<b>237917</b>
				10	1.050	2.000 - 2.200	20	2.200	5	<b>237937</b>

3







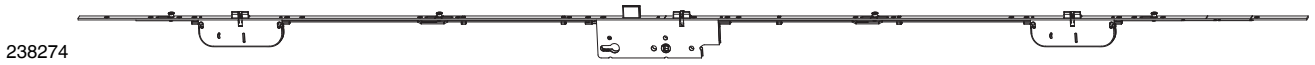

237974

<b>3.2.2.4 Door lock Z-TF PT with 2 MF + 4i.S. E92 F-20 K+500</b>								<b>L</b>		<b>No</b>
extendable	silver	92	35	8	1.050	1.750 - 2.000	20	2.000	5	<b>237970</b>
				10	1.050	1.750 - 2.000	20	2.000	5	<b>237990</b>
			40	8	1.050	1.750 - 2.000	20	2.000	5	<b>237971</b>
				10	1.050	1.750 - 2.000	20	2.000	5	<b>237991</b>
			45	8	1.050	1.750 - 2.000	20	2.000	5	<b>237972</b>
				10	1.050	1.750 - 2.000	20	2.000	5	<b>237992</b>
			50	8	1.050	1.750 - 2.000	20	2.000	5	<b>237973</b>
				10	1.050	1.750 - 2.000	20	2.000	5	<b>237993</b>
			55	8	1.050	1.750 - 2.000	20	2.000	5	<b>237974</b>
				10	1.050	1.750 - 2.000	20	2.000	5	<b>237994</b>
			65	8	1.050	1.750 - 2.000	20	2.000	5	<b>237975</b>
				10	1.050	1.750 - 2.000	20	2.000	5	<b>237995</b>
			70	8	1.050	1.750 - 2.000	20	2.000	5	<b>237976</b>
				10	1.050	1.750 - 2.000	20	2.000	5	<b>237996</b>
			80	8	1.050	1.750 - 2.000	20	2.000	5	<b>237977</b>
				10	1.050	1.750 - 2.000	20	2.000	5	<b>237997</b>

## Flat faceplate 24 mm







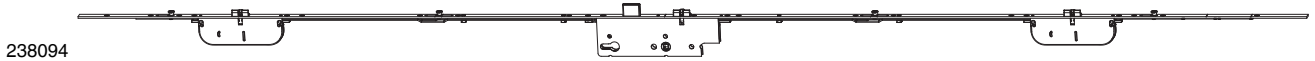

238274

<b>3.2.2.5 Door lock Z-TF PT with 2 MF + 4i.S. E92 F-24</b>								<b>L</b>		<b>No</b>
extendable	silver	92	35	8	1.050	2.000 - 2.200	24	2.200	5	<b>238270</b>
				10	1.050	2.000 - 2.200	24	2.200	5	<b>238290</b>
			40	8	1.050	2.000 - 2.200	24	2.200	5	<b>238271</b>
				10	1.050	2.000 - 2.200	24	2.200	5	<b>238291</b>
			45	8	1.050	2.000 - 2.200	24	2.200	5	<b>238272</b>
				10	1.050	2.000 - 2.200	24	2.200	5	<b>238292</b>
			50	8	1.050	2.000 - 2.200	24	2.200	5	<b>238273</b>
				10	1.050	2.000 - 2.200	24	2.200	5	<b>238293</b>
			55	8	1.050	2.000 - 2.200	24	2.200	5	<b>238274</b>
				10	1.050	2.000 - 2.200	24	2.200	5	<b>238294</b>
			65	8	1.050	2.000 - 2.200	24	2.200	5	<b>238275</b>
				10	1.050	2.000 - 2.200	24	2.200	5	<b>238295</b>
			70	8	1.050	2.000 - 2.200	24	2.200	5	<b>238276</b>
				10	1.050	2.000 - 2.200	24	2.200	5	<b>238296</b>
			80	8	1.050	2.000 - 2.200	24	2.200	5	<b>238277</b>
				10	1.050	2.000 - 2.200	24	2.200	5	<b>238297</b>

## Top hat faceplate 24/16 mm



238094

<b>3.2.2.6 Door lock Z-TF PT with 2 MF + 4i.S. E92 F-24/16</b>								<b>L</b>		<b>No</b>
extendable	silver	92	35	8	1.050	2.000 - 2.200	24/16	2.200	5	<b>238090</b>
				10	1.050	2.000 - 2.200	24/16	2.200	5	<b>238110</b>
			40	8	1.050	2.000 - 2.200	24/16	2.200	5	<b>238091</b>
				10	1.050	2.000 - 2.200	24/16	2.200	5	<b>238111</b>
			45	8	1.050	2.000 - 2.200	24/16	2.200	5	<b>238092</b>
				10	1.050	2.000 - 2.200	24/16	2.200	5	<b>238112</b>
			50	8	1.050	2.000 - 2.200	24/16	2.200	5	<b>238093</b>
				10	1.050	2.000 - 2.200	24/16	2.200	5	<b>238113</b>
			55	8	1.050	2.000 - 2.200	24/16	2.200	5	<b>238094</b>
				10	1.050	2.000 - 2.200	24/16	2.200	5	<b>238114</b>
			65	8	1.050	2.000 - 2.200	24/16	2.200	5	<b>238095</b>
				10	1.050	2.000 - 2.200	24/16	2.200	5	<b>238115</b>
			70	8	1.050	2.000 - 2.200	24/16	2.200	5	<b>238096</b>
				10	1.050	2.000 - 2.200	24/16	2.200	5	<b>238116</b>
			80	8	1.050	2.000 - 2.200	24/16	2.200	5	<b>238097</b>
				10	1.050	2.000 - 2.200	24/16	2.200	5	<b>238117</b>

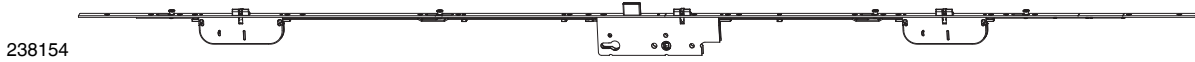

238154

<b>3.2.2.7 Door lock Z-TF PT with 2 MF + 4i.S. E92 F-24/16 K+500</b>							<b>L</b>		<b>No</b>	
extendable	silver	92	35	8	1.050	1.750 - 2.000	24/16	2.000	5	<b>238150</b>
				10	1.050	1.750 - 2.000	24/16	2.000	5	<b>238170</b>
			40	8	1.050	1.750 - 2.000	24/16	2.000	5	<b>238151</b>
				10	1.050	1.750 - 2.000	24/16	2.000	5	<b>238171</b>
			45	8	1.050	1.750 - 2.000	24/16	2.000	5	<b>238152</b>
				10	1.050	1.750 - 2.000	24/16	2.000	5	<b>238172</b>
			50	8	1.050	1.750 - 2.000	24/16	2.000	5	<b>238153</b>
				10	1.050	1.750 - 2.000	24/16	2.000	5	<b>238173</b>
			55	8	1.050	1.750 - 2.000	24/16	2.000	5	<b>238154</b>
				10	1.050	1.750 - 2.000	24/16	2.000	5	<b>238174</b>
			65	8	1.050	1.750 - 2.000	24/16	2.000	5	<b>238155</b>
				10	1.050	1.750 - 2.000	24/16	2.000	5	<b>238175</b>
			70	8	1.050	1.750 - 2.000	24/16	2.000	5	<b>238156</b>
				10	1.050	1.750 - 2.000	24/16	2.000	5	<b>238176</b>
			80	8	1.050	1.750 - 2.000	24/16	2.000	5	<b>238157</b>
				10	1.050	1.750 - 2.000	24/16	2.000	5	<b>238177</b>

Flat faceplate 16 mm

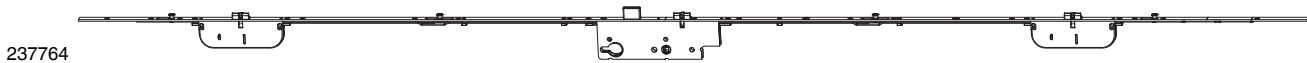

237764

<b>3.2.2.8 Door lock Z-TF PT with 2 MF + 4i.S. E94 F-16</b>							<b>L</b>		<b>No</b>	
extendable	silver	94	35	9	1.050	2.000 - 2.200	16	2.200	5	<b>237760</b>
			40	9	1.050	2.000 - 2.200	16	2.200	5	<b>237761</b>
			45	9	1.050	2.000 - 2.200	16	2.200	5	<b>237762</b>
			50	9	1.050	2.000 - 2.200	16	2.200	5	<b>237763</b>
			55	9	1.050	2.000 - 2.200	16	2.200	5	<b>237764</b>
			65	9	1.050	2.000 - 2.200	16	2.200	5	<b>237765</b>
			70	9	1.050	2.000 - 2.200	16	2.200	5	<b>237766</b>
			80	9	1.050	2.000 - 2.200	16	2.200	5	<b>237767</b>



237824

<b>3.2.2.9 Door lock Z-TF PT with 2 MF + 4i.S. E94 F-16 K+500</b>							<b>L</b>		<b>No</b>	
extendable	silver	94	35	9	1.050	1.750 - 2.000	16	2.000	5	<b>237820</b>
			40	9	1.050	1.750 - 2.000	16	2.000	5	<b>237821</b>
			45	9	1.050	1.750 - 2.000	16	2.000	5	<b>237822</b>
			50	9	1.050	1.750 - 2.000	16	2.000	5	<b>237823</b>
			55	9	1.050	1.750 - 2.000	16	2.000	5	<b>237824</b>
			65	9	1.050	1.750 - 2.000	16	2.000	5	<b>237825</b>
			70	9	1.050	1.750 - 2.000	16	2.000	5	<b>237826</b>
			80	9	1.050	1.750 - 2.000	16	2.000	5	<b>237827</b>

Flat faceplate 20 mm

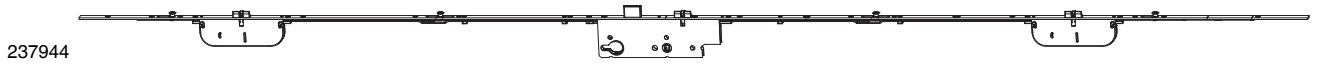

237944

<b>3.2.2.10 Door lock Z-TF PT with 2 MF + 4i.S. E94 F-20</b>											<b>No</b>
extendable	silver	94	35	9	1.050	2.000 - 2.200	20	2.200	5	<b>237940</b>	
			40	9	1.050	2.000 - 2.200	20	2.200	5	<b>237941</b>	
			45	9	1.050	2.000 - 2.200	20	2.200	5	<b>237942</b>	
			50	9	1.050	2.000 - 2.200	20	2.200	5	<b>237943</b>	
			55	9	1.050	2.000 - 2.200	20	2.200	5	<b>237944</b>	
			65	9	1.050	2.000 - 2.200	20	2.200	5	<b>237945</b>	
			70	9	1.050	2.000 - 2.200	20	2.200	5	<b>237946</b>	
			80	9	1.050	2.000 - 2.200	20	2.200	5	<b>237947</b>	

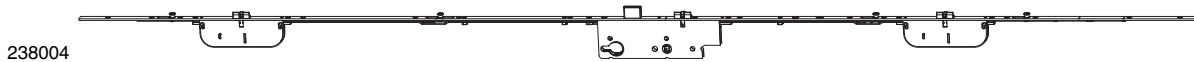

238004

<b>3.2.2.11 Door lock Z-TF PT with 2 MF + 4i.S. E94 F-20 K+500</b>										<b>No</b>
extendable	silver	94	35	9	1.050	1.750 - 2.000	20	2.000	5	<b>238000</b>
			40	9	1.050	1.750 - 2.000	20	2.000	5	<b>238001</b>
			45	9	1.050	1.750 - 2.000	20	2.000	5	<b>238002</b>
			50	9	1.050	1.750 - 2.000	20	2.000	5	<b>238003</b>
			55	9	1.050	1.750 - 2.000	20	2.000	5	<b>238004</b>
			65	9	1.050	1.750 - 2.000	20	2.000	5	<b>238005</b>
			70	9	1.050	1.750 - 2.000	20	2.000	5	<b>238006</b>
			80	9	1.050	1.750 - 2.000	20	2.000	5	<b>238007</b>

Top hat faceplate 24/16 mm

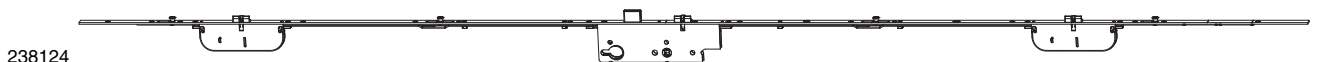

238124

<b>3.2.2.12 Door lock Z-TF PT with 2 MF + 4i.S. E94 F-24/16</b>										<b>No</b>
extendable	silver	94	35	9	1.050	2.000 - 2.200	24/16	2.200	5	<b>238120</b>
			40	9	1.050	2.000 - 2.200	24/16	2.200	5	<b>238121</b>
			45	9	1.050	2.000 - 2.200	24/16	2.200	5	<b>238122</b>
			50	9	1.050	2.000 - 2.200	24/16	2.200	5	<b>238123</b>
			55	9	1.050	2.000 - 2.200	24/16	2.200	5	<b>238124</b>
			65	9	1.050	2.000 - 2.200	24/16	2.200	5	<b>238125</b>
			70	9	1.050	2.000 - 2.200	24/16	2.200	5	<b>238126</b>
			80	9	1.050	2.000 - 2.200	24/16	2.200	5	<b>238127</b>



238184

<b>3.2.2.13 Door lock Z-TF PT with 2 MF + 4i.S. E94 F-24/16 K+500</b>										<b>No</b>
extendable	silver	94	35	9	1.050	1.750 - 2.000	24/16	2.000	5	<b>238180</b>
			40	9	1.050	1.750 - 2.000	24/16	2.000	5	<b>238181</b>
			45	9	1.050	1.750 - 2.000	24/16	2.000	5	<b>238182</b>
			50	9	1.050	1.750 - 2.000	24/16	2.000	5	<b>238183</b>
			55	9	1.050	1.750 - 2.000	24/16	2.000	5	<b>238184</b>
			65	9	1.050	1.750 - 2.000	24/16	2.000	5	<b>238185</b>
			70	9	1.050	1.750 - 2.000	24/16	2.000	5	<b>238186</b>
			80	9	1.050	1.750 - 2.000	24/16	2.000	5	<b>238187</b>

**3.3 Door lock Z-TF PT with MF-BO**

**3.3.1 Door lock Z-TF PT with 2 MF-BO**

Flat faceplate 16 mm

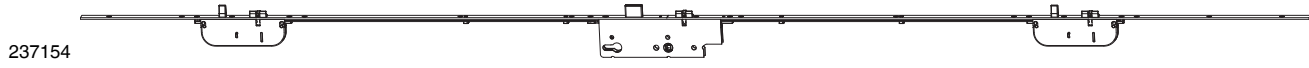

3.3.1.1 Door lock Z-TF PT with 2 MF-BO E92 F-16								<b>L</b>		<b>No</b>
fixed handle height	silver	92	35	8	1.050	2.000 - 2.200	16	2.200	5	<b>237150</b>
				10	1.050	2.000 - 2.200	16	2.200	5	<b>239000</b>
			40	8	1.050	2.000 - 2.200	16	2.200	5	<b>237151</b>
				10	1.050	2.000 - 2.200	16	2.200	5	<b>239001</b>
			45	8	1.050	2.000 - 2.200	16	2.200	5	<b>237152</b>
				10	1.050	2.000 - 2.200	16	2.200	5	<b>239002</b>
			50	8	1.050	2.000 - 2.200	16	2.200	5	<b>237153</b>
				10	1.050	2.000 - 2.200	16	2.200	5	<b>239003</b>
			55	8	1.050	2.000 - 2.200	16	2.200	5	<b>237154</b>
				10	1.050	2.000 - 2.200	16	2.200	5	<b>239004</b>
			65	8	1.050	2.000 - 2.200	16	2.200	5	<b>237155</b>
				10	1.050	2.000 - 2.200	16	2.200	5	<b>239005</b>
			70	8	1.050	2.000 - 2.200	16	2.200	5	<b>237156</b>
				10	1.050	2.000 - 2.200	16	2.200	5	<b>239006</b>
			80	8	1.050	2.000 - 2.200	16	2.200	5	<b>237157</b>
				10	1.050	2.000 - 2.200	16	2.200	5	<b>239007</b>



3.3.1.2 Door lock Z-TF PT with 2 MF-BO E92 F-16 K+605								<b>L</b>		<b>No</b>
fixed handle height	silver	92	35	8	1.050	1.800 - 2.000	16	2.000	5	<b>239040</b>
				10	1.050	1.800 - 2.000	16	2.000	5	<b>239050</b>
			40	8	1.050	1.800 - 2.000	16	2.000	5	<b>239041</b>
				10	1.050	1.800 - 2.000	16	2.000	5	<b>239051</b>
			45	8	1.050	1.800 - 2.000	16	2.000	5	<b>239042</b>
				10	1.050	1.800 - 2.000	16	2.000	5	<b>239052</b>
			50	8	1.050	1.800 - 2.000	16	2.000	5	<b>239043</b>
				10	1.050	1.800 - 2.000	16	2.000	5	<b>239053</b>
			55	8	1.050	1.800 - 2.000	16	2.000	5	<b>239044</b>
				10	1.050	1.800 - 2.000	16	2.000	5	<b>239054</b>
			65	8	1.050	1.800 - 2.000	16	2.000	5	<b>239045</b>
				10	1.050	1.800 - 2.000	16	2.000	5	<b>239055</b>
			70	8	1.050	1.800 - 2.000	16	2.000	5	<b>239046</b>
				10	1.050	1.800 - 2.000	16	2.000	5	<b>239056</b>
			80	8	1.050	1.800 - 2.000	16	2.000	5	<b>239047</b>
				10	1.050	1.800 - 2.000	16	2.000	5	<b>239057</b>

239094



**3.3.1.3 Door lock Z-TF PT  
with 2 MF-BO E92 F-16 K+980**

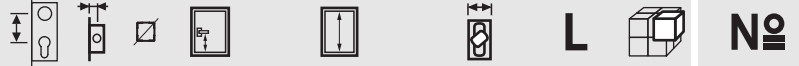

fixed handle height	silver	92	35	8	1.050	2.200 - 2.400	16	2.400	5	No
				10	1.050	2.200 - 2.400	16	2.400	5	<b>239100</b>
			40	8	1.050	2.200 - 2.400	16	2.400	5	<b>239091</b>
				10	1.050	2.200 - 2.400	16	2.400	5	<b>239101</b>
			45	8	1.050	2.200 - 2.400	16	2.400	5	<b>239092</b>
				10	1.050	2.200 - 2.400	16	2.400	5	<b>239102</b>
			50	8	1.050	2.200 - 2.400	16	2.400	5	<b>239093</b>
				10	1.050	2.200 - 2.400	16	2.400	5	<b>239103</b>
			55	8	1.050	2.200 - 2.400	16	2.400	5	<b>239094</b>
				10	1.050	2.200 - 2.400	16	2.400	5	<b>239104</b>
			65	8	1.050	2.200 - 2.400	16	2.400	5	<b>239095</b>
				10	1.050	2.200 - 2.400	16	2.400	5	<b>239105</b>
			70	8	1.050	2.200 - 2.400	16	2.400	5	<b>239096</b>
				10	1.050	2.200 - 2.400	16	2.400	5	<b>239106</b>
			80	8	1.050	2.200 - 2.400	16	2.400	5	<b>239097</b>
				10	1.050	2.200 - 2.400	16	2.400	5	<b>239107</b>

**Flat faceplate 20 mm**

239144

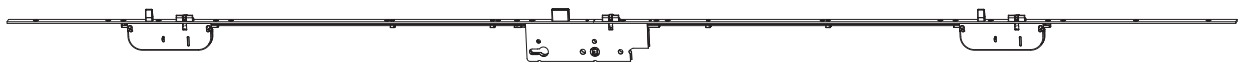

**3.3.1.4 Door lock Z-TF PT  
with 2 MF-BO E92 F-20**

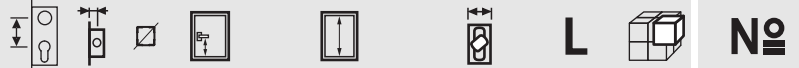

fixed handle height	silver	92	35	8	1.050	2.000 - 2.200	20	2.200	5	No
				10	1.050	2.000 - 2.200	20	2.200	5	<b>239150</b>
			40	8	1.050	2.000 - 2.200	20	2.200	5	<b>239141</b>
				10	1.050	2.000 - 2.200	20	2.200	5	<b>239151</b>
			45	8	1.050	2.000 - 2.200	20	2.200	5	<b>239142</b>
				10	1.050	2.000 - 2.200	20	2.200	5	<b>239152</b>
			50	8	1.050	2.000 - 2.200	20	2.200	5	<b>239143</b>
				10	1.050	2.000 - 2.200	20	2.200	5	<b>239153</b>
			55	8	1.050	2.000 - 2.200	20	2.200	5	<b>239144</b>
				10	1.050	2.000 - 2.200	20	2.200	5	<b>239154</b>
			65	8	1.050	2.000 - 2.200	20	2.200	5	<b>239145</b>
				10	1.050	2.000 - 2.200	20	2.200	5	<b>239155</b>
			70	8	1.050	2.000 - 2.200	20	2.200	5	<b>239146</b>
				10	1.050	2.000 - 2.200	20	2.200	5	<b>239156</b>
			80	8	1.050	2.000 - 2.200	20	2.200	5	<b>239147</b>
				10	1.050	2.000 - 2.200	20	2.200	5	<b>239157</b>



239194

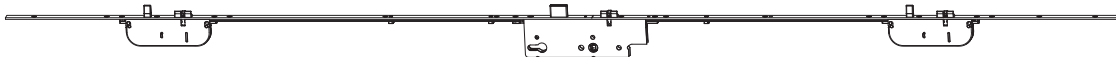

**3.3.1.5 Door lock Z-TF PT  
with 2 MF-BO E92 F-20 K+605**



fixed handle height	silver	92	35	8	1.050	1.800 - 2.000	20	2.000	5	<b>No</b>
				10	1.050	1.800 - 2.000	20	2.000	5	<b>239190</b>
			40	8	1.050	1.800 - 2.000	20	2.000	5	<b>239191</b>
				10	1.050	1.800 - 2.000	20	2.000	5	<b>239201</b>
			45	8	1.050	1.800 - 2.000	20	2.000	5	<b>239192</b>
				10	1.050	1.800 - 2.000	20	2.000	5	<b>239202</b>
			50	8	1.050	1.800 - 2.000	20	2.000	5	<b>239193</b>
				10	1.050	1.800 - 2.000	20	2.000	5	<b>239203</b>
			55	8	1.050	1.800 - 2.000	20	2.000	5	<b>239194</b>
				10	1.050	1.800 - 2.000	20	2.000	5	<b>239204</b>
			65	8	1.050	1.800 - 2.000	20	2.000	5	<b>239195</b>
				10	1.050	1.800 - 2.000	20	2.000	5	<b>239205</b>
			70	8	1.050	1.800 - 2.000	20	2.000	5	<b>239196</b>
				10	1.050	1.800 - 2.000	20	2.000	5	<b>239206</b>
			80	8	1.050	1.800 - 2.000	20	2.000	5	<b>239197</b>
				10	1.050	1.800 - 2.000	20	2.000	5	<b>239207</b>

239244



**3.3.1.6 Door lock Z-TF PT  
with 2 MF-BO E92 F-20 K+980**







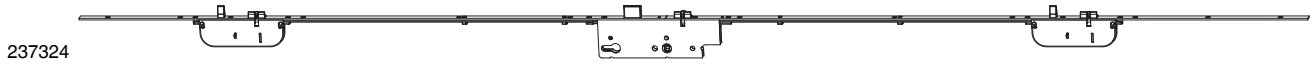





fixed handle height	silver	92	35	8	1.050	2.200 - 2.400	20	2.400	5	<b>No</b>
				10	1.050	2.200 - 2.400	20	2.400	5	<b>239240</b>
			40	8	1.050	2.200 - 2.400	20	2.400	5	<b>239241</b>
				10	1.050	2.200 - 2.400	20	2.400	5	<b>239251</b>
			45	8	1.050	2.200 - 2.400	20	2.400	5	<b>239242</b>
				10	1.050	2.200 - 2.400	20	2.400	5	<b>239252</b>
			50	8	1.050	2.200 - 2.400	20	2.400	5	<b>239243</b>
				10	1.050	2.200 - 2.400	20	2.400	5	<b>239253</b>
			55	8	1.050	2.200 - 2.400	20	2.400	5	<b>239244</b>
				10	1.050	2.200 - 2.400	20	2.400	5	<b>239254</b>
			65	8	1.050	2.200 - 2.400	20	2.400	5	<b>239245</b>
				10	1.050	2.200 - 2.400	20	2.400	5	<b>239255</b>
			70	8	1.050	2.200 - 2.400	20	2.400	5	<b>239246</b>
				10	1.050	2.200 - 2.400	20	2.400	5	<b>239256</b>
			80	8	1.050	2.200 - 2.400	20	2.400	5	<b>239247</b>
				10	1.050	2.200 - 2.400	20	2.400	5	<b>239257</b>

Flat faceplate 24 mm







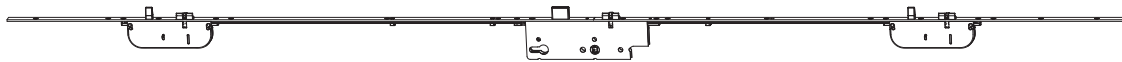





237324

<b>3.3.1.7 Door lock Z-TF PT with 2 MF-BO E92 F-24</b>													<b>No</b>
fixed handle height	silver	92	35	8	1.050	2.000 - 2.200	24	2.200	5				<b>237320</b>
				10	1.050	2.000 - 2.200	24	2.200	5				<b>237330</b>
			40	8	1.050	2.000 - 2.200	24	2.200	5				<b>237321</b>
				10	1.050	2.000 - 2.200	24	2.200	5				<b>237331</b>
			45	8	1.050	2.000 - 2.200	24	2.200	5				<b>237322</b>
				10	1.050	2.000 - 2.200	24	2.200	5				<b>237332</b>
			50	8	1.050	2.000 - 2.200	24	2.200	5				<b>237323</b>
				10	1.050	2.000 - 2.200	24	2.200	5				<b>237333</b>
			55	8	1.050	2.000 - 2.200	24	2.200	5				<b>237324</b>
				10	1.050	2.000 - 2.200	24	2.200	5				<b>237334</b>
			65	8	1.050	2.000 - 2.200	24	2.200	5				<b>237325</b>
				10	1.050	2.000 - 2.200	24	2.200	5				<b>237335</b>
			70	8	1.050	2.000 - 2.200	24	2.200	5				<b>237326</b>
				10	1.050	2.000 - 2.200	24	2.200	5				<b>237336</b>
			80	8	1.050	2.000 - 2.200	24	2.200	5				<b>237327</b>
				10	1.050	2.000 - 2.200	24	2.200	5				<b>237337</b>



237374

<b>3.3.1.8 Door lock Z-TF PT with 2 MF-BO E92 F-24 K+605</b>													<b>No</b>
fixed handle height	silver	92	35	8	1.050	1.800 - 2.000	24	2.000	5				<b>237370</b>
				10	1.050	1.800 - 2.000	24	2.000	5				<b>237380</b>
			40	8	1.050	1.800 - 2.000	24	2.000	5				<b>237371</b>
				10	1.050	1.800 - 2.000	24	2.000	5				<b>237381</b>
			45	8	1.050	1.800 - 2.000	24	2.000	5				<b>237372</b>
				10	1.050	1.800 - 2.000	24	2.000	5				<b>237382</b>
			50	8	1.050	1.800 - 2.000	24	2.000	5				<b>237373</b>
				10	1.050	1.800 - 2.000	24	2.000	5				<b>237383</b>
			55	8	1.050	1.800 - 2.000	24	2.000	5				<b>237374</b>
				10	1.050	1.800 - 2.000	24	2.000	5				<b>237384</b>
			65	8	1.050	1.800 - 2.000	24	2.000	5				<b>237375</b>
				10	1.050	1.800 - 2.000	24	2.000	5				<b>237385</b>
			70	8	1.050	1.800 - 2.000	24	2.000	5				<b>237376</b>
				10	1.050	1.800 - 2.000	24	2.000	5				<b>237386</b>
			80	8	1.050	1.800 - 2.000	24	2.000	5				<b>237377</b>
				10	1.050	1.800 - 2.000	24	2.000	5				<b>237387</b>

237394



**3.3.1.9 Door lock Z-TF PT  
with 2 MF-BO E92 F-24 K+980**



fixed handle height	silver	92	35	8	1.050	2.200 - 2.400	24	2.400	5	<b>No</b>
				10	1.050	2.200 - 2.400	24	2.400	5	<b>237390</b>
			40	8	1.050	2.200 - 2.400	24	2.400	5	<b>237400</b>
				10	1.050	2.200 - 2.400	24	2.400	5	<b>237391</b>
			45	8	1.050	2.200 - 2.400	24	2.400	5	<b>237401</b>
				10	1.050	2.200 - 2.400	24	2.400	5	<b>237392</b>
			50	8	1.050	2.200 - 2.400	24	2.400	5	<b>237402</b>
				10	1.050	2.200 - 2.400	24	2.400	5	<b>237393</b>
			55	8	1.050	2.200 - 2.400	24	2.400	5	<b>237403</b>
				10	1.050	2.200 - 2.400	24	2.400	5	<b>237394</b>
			65	8	1.050	2.200 - 2.400	24	2.400	5	<b>237404</b>
				10	1.050	2.200 - 2.400	24	2.400	5	<b>237395</b>
			70	8	1.050	2.200 - 2.400	24	2.400	5	<b>237405</b>
				10	1.050	2.200 - 2.400	24	2.400	5	<b>237396</b>
			80	8	1.050	2.200 - 2.400	24	2.400	5	<b>237397</b>
				10	1.050	2.200 - 2.400	24	2.400	5	<b>237406</b>
										<b>237397</b>
										<b>237407</b>

**Top hat faceplate 24/16 mm**

239324

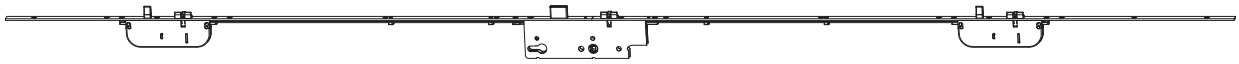

**3.3.1.10 Door lock Z-TF PT  
with 2 MF-BO E92 F-24/16**







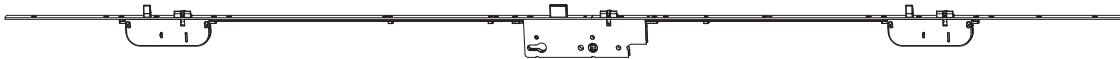



fixed handle height	silver	92	35	8	1.050	2.000 - 2.200	24/16	2.200	5	<b>No</b>
				10	1.050	2.000 - 2.200	24/16	2.200	5	<b>239320</b>
			40	8	1.050	2.000 - 2.200	24/16	2.200	5	<b>239330</b>
				10	1.050	2.000 - 2.200	24/16	2.200	5	<b>239321</b>
			45	8	1.050	2.000 - 2.200	24/16	2.200	5	<b>239331</b>
				10	1.050	2.000 - 2.200	24/16	2.200	5	<b>239322</b>
			50	8	1.050	2.000 - 2.200	24/16	2.200	5	<b>239332</b>
				10	1.050	2.000 - 2.200	24/16	2.200	5	<b>239323</b>
			55	8	1.050	2.000 - 2.200	24/16	2.200	5	<b>239333</b>
				10	1.050	2.000 - 2.200	24/16	2.200	5	<b>239324</b>
			65	8	1.050	2.000 - 2.200	24/16	2.200	5	<b>239334</b>
				10	1.050	2.000 - 2.200	24/16	2.200	5	<b>239325</b>
			70	8	1.050	2.000 - 2.200	24/16	2.200	5	<b>239335</b>
				10	1.050	2.000 - 2.200	24/16	2.200	5	<b>239326</b>
			80	8	1.050	2.000 - 2.200	24/16	2.200	5	<b>239336</b>
				10	1.050	2.000 - 2.200	24/16	2.200	5	<b>239327</b>
										<b>239337</b>

239374











**3.3.1.11 Door lock Z-TF PT  
with 2 MF-BO E92 F-24/16 K+605**

										<b>No</b>
fixed handle height	silver	92	35	8	1.050	1.800 - 2.000	24/16	2.000	5	<b>239370</b>
				10	1.050	1.800 - 2.000	24/16	2.000	5	<b>239380</b>
			40	8	1.050	1.800 - 2.000	24/16	2.000	5	<b>239371</b>
				10	1.050	1.800 - 2.000	24/16	2.000	5	<b>239381</b>
			45	8	1.050	1.800 - 2.000	24/16	2.000	5	<b>239372</b>
				10	1.050	1.800 - 2.000	24/16	2.000	5	<b>239382</b>
			50	8	1.050	1.800 - 2.000	24/16	2.000	5	<b>239373</b>
				10	1.050	1.800 - 2.000	24/16	2.000	5	<b>239383</b>
			55	8	1.050	1.800 - 2.000	24/16	2.000	5	<b>239374</b>
				10	1.050	1.800 - 2.000	24/16	2.000	5	<b>239384</b>
			65	8	1.050	1.800 - 2.000	24/16	2.000	5	<b>239375</b>
				10	1.050	1.800 - 2.000	24/16	2.000	5	<b>239385</b>
			70	8	1.050	1.800 - 2.000	24/16	2.000	5	<b>239376</b>
				10	1.050	1.800 - 2.000	24/16	2.000	5	<b>239386</b>
			80	8	1.050	1.800 - 2.000	24/16	2.000	5	<b>239377</b>
				10	1.050	1.800 - 2.000	24/16	2.000	5	<b>239387</b>

239424



**3.3.1.12 Door lock Z-TF PT  
with 2 MF-BO E92 F-24/16 K+980**

										<b>No</b>
fixed handle height	silver	92	35	8	1.050	2.200 - 2.400	24/16	2.400	5	<b>239420</b>
				10	1.050	2.200 - 2.400	24/16	2.400	5	<b>239430</b>
			40	8	1.050	2.200 - 2.400	24/16	2.400	5	<b>239421</b>
				10	1.050	2.200 - 2.400	24/16	2.400	5	<b>239431</b>
			45	8	1.050	2.200 - 2.400	24/16	2.400	5	<b>239422</b>
				10	1.050	2.200 - 2.400	24/16	2.400	5	<b>239432</b>
			50	8	1.050	2.200 - 2.400	24/16	2.400	5	<b>239423</b>
				10	1.050	2.200 - 2.400	24/16	2.400	5	<b>239433</b>
			55	8	1.050	2.200 - 2.400	24/16	2.400	5	<b>239424</b>
				10	1.050	2.200 - 2.400	24/16	2.400	5	<b>239434</b>
			65	8	1.050	2.200 - 2.400	24/16	2.400	5	<b>239425</b>
				10	1.050	2.200 - 2.400	24/16	2.400	5	<b>239435</b>
			70	8	1.050	2.200 - 2.400	24/16	2.400	5	<b>239426</b>
				10	1.050	2.200 - 2.400	24/16	2.400	5	<b>239436</b>
			80	8	1.050	2.200 - 2.400	24/16	2.400	5	<b>239427</b>
				10	1.050	2.200 - 2.400	24/16	2.400	5	<b>239437</b>

U-faceplate 6x24x6 mm

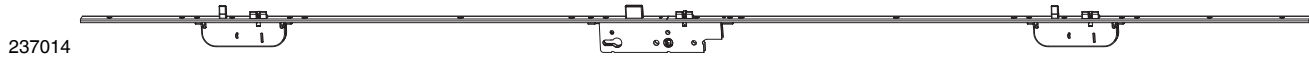

237014

<b>3.3.1.13 Door lock Z-TF PT with 2 MF-BO E92 U-6x24x6</b>								<b>L</b>		<b>No</b>
fixed handle height	silver	92	35	8	1.050	1.950 - 2.200	24	2.200	5	<b>237010</b>
				10	1.050	1.950 - 2.200	24	2.200	5	<b>237180</b>
			40	8	1.050	1.950 - 2.200	24	2.200	5	<b>237011</b>
				10	1.050	1.950 - 2.200	24	2.200	5	<b>237181</b>
			45	8	1.050	1.950 - 2.200	24	2.200	5	<b>237012</b>
				10	1.050	1.950 - 2.200	24	2.200	5	<b>237182</b>
			50	8	1.050	1.950 - 2.200	24	2.200	5	<b>237013</b>
				10	1.050	1.950 - 2.200	24	2.200	5	<b>237183</b>
			55	8	1.050	1.950 - 2.200	24	2.200	5	<b>237014</b>
				10	1.050	1.950 - 2.200	24	2.200	5	<b>237184</b>
			65	8	1.050	1.950 - 2.200	24	2.200	5	<b>237015</b>
				10	1.050	1.950 - 2.200	24	2.200	5	<b>237185</b>
			70	8	1.050	1.950 - 2.200	24	2.200	5	<b>237016</b>
				10	1.050	1.950 - 2.200	24	2.200	5	<b>237186</b>
			80	8	1.050	1.950 - 2.200	24	2.200	5	<b>237017</b>
				10	1.050	1.950 - 2.200	24	2.200	5	<b>237187</b>

3

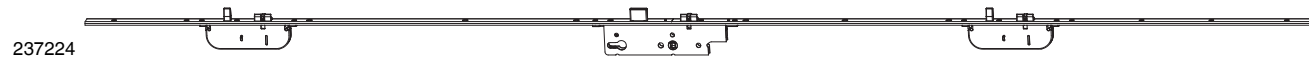

237224

<b>3.3.1.14 Door lock Z-TF PT with 2 MF-BO E92 U-6x24x6 K+605</b>							<b>L</b>		<b>No</b>	
fixed handle height	silver	92	35	8	1.050	1.800 - 2.000	24	2.200	5	<b>237220</b>
				10	1.050	1.800 - 2.000	24	2.200	5	<b>237230</b>
			40	8	1.050	1.800 - 2.000	24	2.200	5	<b>237221</b>
				10	1.050	1.800 - 2.000	24	2.200	5	<b>237231</b>
			45	8	1.050	1.800 - 2.000	24	2.200	5	<b>237222</b>
				10	1.050	1.800 - 2.000	24	2.200	5	<b>237232</b>
			50	8	1.050	1.800 - 2.000	24	2.200	5	<b>237223</b>
				10	1.050	1.800 - 2.000	24	2.200	5	<b>237233</b>
			55	8	1.050	1.800 - 2.000	24	2.200	5	<b>237224</b>
				10	1.050	1.800 - 2.000	24	2.200	5	<b>237234</b>
			65	8	1.050	1.800 - 2.000	24	2.200	5	<b>237225</b>
				10	1.050	1.800 - 2.000	24	2.200	5	<b>237235</b>
			70	8	1.050	1.800 - 2.000	24	2.200	5	<b>237226</b>
				10	1.050	1.800 - 2.000	24	2.200	5	<b>237236</b>
			80	8	1.050	1.800 - 2.000	24	2.200	5	<b>237227</b>
				10	1.050	1.800 - 2.000	24	2.200	5	<b>237237</b>

237274



**3.3.1.15 Door lock Z-TF PT  
with 2 MF-BO E92 U-6x24x6 K+980**



fixed handle height	silver	92	35	8	1.050	2.200 - 2.400	24	2.200	5	No
				10	1.050	2.200 - 2.400	24	2.200	5	<b>237280</b>
			40	8	1.050	2.200 - 2.400	24	2.200	5	<b>237271</b>
				10	1.050	2.200 - 2.400	24	2.200	5	<b>237281</b>
			45	8	1.050	2.200 - 2.400	24	2.200	5	<b>237272</b>
				10	1.050	2.200 - 2.400	24	2.200	5	<b>237282</b>
			50	8	1.050	2.200 - 2.400	24	2.200	5	<b>237273</b>
				10	1.050	2.200 - 2.400	24	2.200	5	<b>237283</b>
			55	8	1.050	2.200 - 2.400	24	2.200	5	<b>237274</b>
				10	1.050	2.200 - 2.400	24	2.200	5	<b>237284</b>
			65	8	1.050	2.200 - 2.400	24	2.200	5	<b>237275</b>
				10	1.050	2.200 - 2.400	24	2.200	5	<b>237285</b>
			70	8	1.050	2.200 - 2.400	24	2.200	5	<b>237276</b>
				10	1.050	2.200 - 2.400	24	2.200	5	<b>237286</b>
			80	8	1.050	2.200 - 2.400	24	2.200	5	<b>237277</b>
				10	1.050	2.200 - 2.400	24	2.200	5	<b>237287</b>

**Flat faceplate 16 mm**

239024

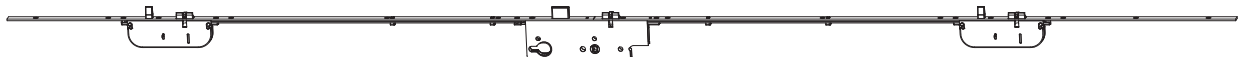

**3.3.1.16 Door lock Z-TF PT  
with 2 MF-BO E94 F-16**



fixed handle height	silver	94	35	9	1.050	2.000 - 2.200	16	2.200	5	No
			40	9	1.050	2.000 - 2.200	16	2.200	5	<b>239021</b>
			45	9	1.050	2.000 - 2.200	16	2.200	5	<b>239022</b>
			50	9	1.050	2.000 - 2.200	16	2.200	5	<b>239023</b>
			55	9	1.050	2.000 - 2.200	16	2.200	5	<b>239024</b>
			65	9	1.050	2.000 - 2.200	16	2.200	5	<b>239025</b>
			70	9	1.050	2.000 - 2.200	16	2.200	5	<b>239026</b>
			80	9	1.050	2.000 - 2.200	16	2.200	5	<b>239027</b>

239074



**3.3.1.17 Door lock Z-TF PT  
with 2 MF-BO E94 F-16 K+605**



fixed handle height	silver	94	35	9	1.050	2.000 - 2.200	16	2.000	5	No
			40	9	1.050	2.000 - 2.200	16	2.000	5	<b>239071</b>
			45	9	1.050	2.000 - 2.200	16	2.000	5	<b>239072</b>
			50	9	1.050	2.000 - 2.200	16	2.000	5	<b>239073</b>
			55	9	1.050	2.000 - 2.200	16	2.000	5	<b>239074</b>
			65	9	1.050	2.000 - 2.200	16	2.000	5	<b>239075</b>
			70	9	1.050	2.000 - 2.200	16	2.000	5	<b>239076</b>
			80	9	1.050	2.000 - 2.200	16	2.000	5	<b>239077</b>

239124



**3.3.1.18 Door lock Z-TF PT  
with 2 MF-BO E94 F-16 K+980**



fixed handle height	silver	94	35	9	1.050	2.000 - 2.200	16	2.400	5	<b>№</b>
			40	9	1.050	2.000 - 2.200	16	2.400	5	<b>239120</b>
			45	9	1.050	2.000 - 2.200	16	2.400	5	<b>239121</b>
			50	9	1.050	2.000 - 2.200	16	2.400	5	<b>239122</b>
			55	9	1.050	2.000 - 2.200	16	2.400	5	<b>239123</b>
			65	9	1.050	2.000 - 2.200	16	2.400	5	<b>239124</b>
			70	9	1.050	2.000 - 2.200	16	2.400	5	<b>239125</b>
			80	9	1.050	2.000 - 2.200	16	2.400	5	<b>239126</b>
										<b>239127</b>

**Flat faceplate 20 mm**

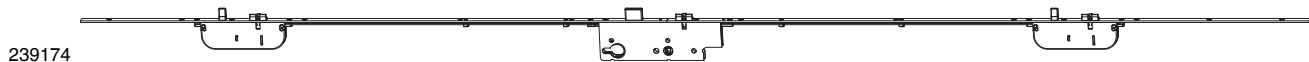

239174

**3.3.1.19 Door lock Z-TF PT  
with 2 MF-BO E94 F-20**



fixed handle height	silver	94	35	9	1.050	1.800 - 2.000	20	2.200	5	<b>№</b>
			40	9	1.050	1.800 - 2.000	20	2.200	5	<b>239170</b>
			45	9	1.050	1.800 - 2.000	20	2.200	5	<b>239171</b>
			50	9	1.050	1.800 - 2.000	20	2.200	5	<b>239172</b>
			55	9	1.050	1.800 - 2.000	20	2.200	5	<b>239173</b>
			65	9	1.050	1.800 - 2.000	20	2.200	5	<b>239174</b>
			70	9	1.050	1.800 - 2.000	20	2.200	5	<b>239175</b>
			80	9	1.050	1.800 - 2.000	20	2.200	5	<b>239176</b>
										<b>239177</b>



239224

**3.3.1.20 Door lock Z-TF PT  
with 2 MF-BO E94 F-20 K+605**



fixed handle height	silver	94	35	9	1.050	2.000 - 2.200	20	2.000	5	<b>№</b>
			40	9	1.050	2.000 - 2.200	20	2.000	5	<b>239220</b>
			45	9	1.050	2.000 - 2.200	20	2.000	5	<b>239221</b>
			50	9	1.050	2.000 - 2.200	20	2.000	5	<b>239222</b>
			55	9	1.050	2.000 - 2.200	20	2.000	5	<b>239223</b>
			65	9	1.050	2.000 - 2.200	20	2.000	5	<b>239224</b>
			70	9	1.050	2.000 - 2.200	20	2.000	5	<b>239225</b>
			80	9	1.050	2.000 - 2.200	20	2.000	5	<b>239226</b>
										<b>239227</b>

239274



**3.3.1.21 Door lock Z-TF PT  
with 2 MF-BO E94 F-20 K+980**



fixed handle height	silver	94	35	9	1.050	2.200 - 2.400	20	2.400	5	<b>No</b>
			40	9	1.050	2.200 - 2.400	20	2.400	5	<b>239270</b>
			45	9	1.050	2.200 - 2.400	20	2.400	5	<b>239271</b>
			50	9	1.050	2.200 - 2.400	20	2.400	5	<b>239272</b>
			55	9	1.050	2.200 - 2.400	20	2.400	5	<b>239273</b>
			55	9	1.050	2.200 - 2.400	20	2.400	5	<b>239274</b>
			65	9	1.050	2.200 - 2.400	20	2.400	5	<b>239275</b>
			70	9	1.050	2.200 - 2.400	20	2.400	5	<b>239276</b>
			80	9	1.050	2.200 - 2.400	20	2.400	5	<b>239277</b>

**Flat faceplate 24 mm**

237354

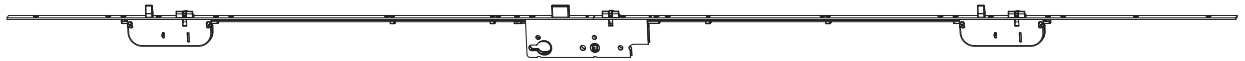

**3.3.1.22 Door lock Z-TF PT  
with 2 MF-BO E94 F-24**



fixed handle height	silver	94	35	9	1.050	2.000 - 2.200	24	2.200	5	<b>No</b>
			40	9	1.050	2.000 - 2.200	24	2.200	5	<b>237350</b>
			45	9	1.050	2.000 - 2.200	24	2.200	5	<b>237351</b>
			50	9	1.050	2.000 - 2.200	24	2.200	5	<b>237352</b>
			50	9	1.050	2.000 - 2.200	24	2.200	5	<b>237353</b>
			55	9	1.050	2.000 - 2.200	24	2.200	5	<b>237354</b>
			65	9	1.050	2.000 - 2.200	24	2.200	5	<b>237355</b>
			70	9	1.050	2.000 - 2.200	24	2.200	5	<b>237356</b>
			80	9	1.050	2.000 - 2.200	24	2.200	5	<b>237357</b>

237484

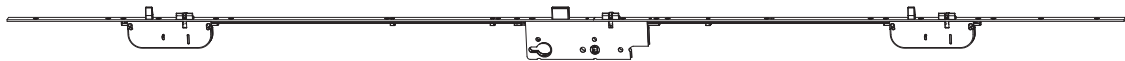

**3.3.1.23 Door lock Z-TF PT  
with 2 MF-BO E94 F-24 K+605**



fixed handle height	silver	94	35	9	1.050	1.800 - 2.000	24	2.000	5	<b>No</b>
			40	9	1.050	1.800 - 2.000	24	2.000	5	<b>237480</b>
			45	9	1.050	1.800 - 2.000	24	2.000	5	<b>237481</b>
			50	9	1.050	1.800 - 2.000	24	2.000	5	<b>237482</b>
			50	9	1.050	1.800 - 2.000	24	2.000	5	<b>237483</b>
			55	9	1.050	1.800 - 2.000	24	2.000	5	<b>237484</b>
			65	9	1.050	1.800 - 2.000	24	2.000	5	<b>237485</b>
			70	9	1.050	1.800 - 2.000	24	2.000	5	<b>237486</b>
			80	9	1.050	1.800 - 2.000	24	2.000	5	<b>237487</b>

239304



**3.3.1.24 Door lock Z-TF PT  
with 2 MF-BO E94 F-24 K+980**



fixed handle height	silver	94	35	9	1.050	2.200 - 2.400	24	2.400	5	<b>№</b>
			40	9	1.050	2.200 - 2.400	24	2.400	5	<b>239301</b>
			45	9	1.050	2.200 - 2.400	24	2.400	5	<b>239302</b>
			50	9	1.050	2.200 - 2.400	24	2.400	5	<b>239303</b>
			55	9	1.050	2.200 - 2.400	24	2.400	5	<b>239304</b>
			65	9	1.050	2.200 - 2.400	24	2.400	5	<b>239305</b>
			70	9	1.050	2.200 - 2.400	24	2.400	5	<b>239306</b>
			80	9	1.050	2.200 - 2.400	24	2.400	5	<b>239307</b>

**Top hat faceplate 24/16 mm**

239354

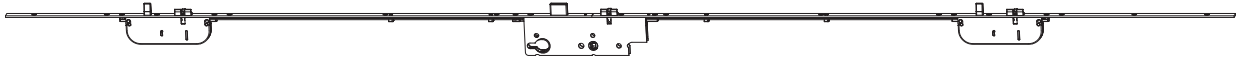

**3.3.1.25 Door lock Z-TF PT  
with 2 MF-BO E94 F-24/16**



fixed handle height	silver	94	35	9	1.050	2.000 - 2.200	24/16	2.200	5	<b>№</b>
			40	9	1.050	2.000 - 2.200	24/16	2.200	5	<b>239351</b>
			45	9	1.050	2.000 - 2.200	24/16	2.200	5	<b>239352</b>
			50	9	1.050	2.000 - 2.200	24/16	2.200	5	<b>239353</b>
			55	9	1.050	2.000 - 2.200	24/16	2.200	5	<b>239354</b>
			65	9	1.050	2.000 - 2.200	24/16	2.200	5	<b>239355</b>
			70	9	1.050	2.000 - 2.200	24/16	2.200	5	<b>239356</b>
			80	9	1.050	2.000 - 2.200	24/16	2.200	5	<b>239357</b>

239404

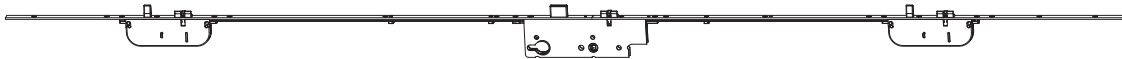

**3.3.1.26 Door lock Z-TF PT  
with 2 MF-BO E94 F-24/16 K+605**



fixed handle height	silver	94	35	9	1.050	1.800 - 2.000	24/16	2.000	5	<b>№</b>
			40	9	1.050	1.800 - 2.000	24/16	2.000	5	<b>239401</b>
			45	9	1.050	1.800 - 2.000	24/16	2.000	5	<b>239402</b>
			50	9	1.050	1.800 - 2.000	24/16	2.000	5	<b>239403</b>
			55	9	1.050	1.800 - 2.000	24/16	2.000	5	<b>239404</b>
			65	9	1.050	1.800 - 2.000	24/16	2.000	5	<b>239405</b>
			70	9	1.050	1.800 - 2.000	24/16	2.000	5	<b>239406</b>
			80	9	1.050	1.800 - 2.000	24/16	2.000	5	<b>239407</b>

3

239454



<b>3.3.1.27 Door lock Z-TF PT with 2 MF-BO E94 F-24/16 K+980</b>											
fixed handle height	silver	94	35	9	1.050	2.200 - 2.400	24/16	2.400	5	<b>239450</b>	
			40	9	1.050	2.200 - 2.400	24/16	2.400	5	<b>239451</b>	
			45	9	1.050	2.200 - 2.400	24/16	2.400	5	<b>239452</b>	
			50	9	1.050	2.200 - 2.400	24/16	2.400	5	<b>239453</b>	
			55	9	1.050	2.200 - 2.400	24/16	2.400	5	<b>239454</b>	
			65	9	1.050	2.200 - 2.400	24/16	2.400	5	<b>239455</b>	
			70	9	1.050	2.200 - 2.400	24/16	2.400	5	<b>239456</b>	
			80	9	1.050	2.200 - 2.400	24/16	2.400	5	<b>239457</b>	

**U-faceplate 6x24x6 mm**

237204



<b>3.3.1.28 Door lock Z-TF PT with 2 MF-BO E94 U-6x24x6</b>										
fixed handle height	silver	94	35	9	1.050	1.950 - 2.200	24	2.200	5	<b>237200</b>
			40	9	1.050	1.950 - 2.200	24	2.200	5	<b>237201</b>
			45	9	1.050	1.950 - 2.200	24	2.200	5	<b>237202</b>
			50	9	1.050	1.950 - 2.200	24	2.200	5	<b>237203</b>
			55	9	1.050	1.950 - 2.200	24	2.200	5	<b>237204</b>
			65	9	1.050	1.950 - 2.200	24	2.200	5	<b>237205</b>
			70	9	1.050	1.950 - 2.200	24	2.200	5	<b>237206</b>
			80	9	1.050	1.950 - 2.200	24	2.200	5	<b>237207</b>



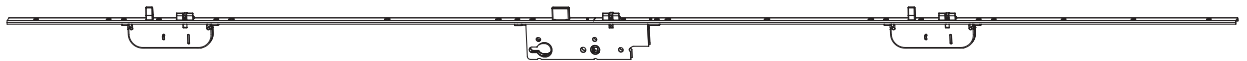



237254

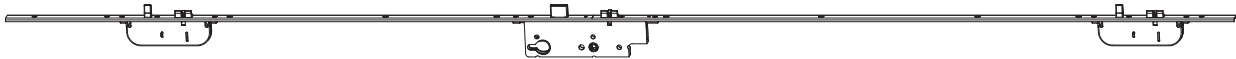

<b>3.3.1.29 Door lock Z-TF PT with 2 MF-BO E94 U-6x24x6 K+605</b>										
fixed handle height	silver	94	35	9	1.050	1.950 - 2.200	24	2.200	5	<b>237250</b>
			40	9	1.050	1.950 - 2.200	24	2.200	5	<b>237251</b>
			45	9	1.050	1.950 - 2.200	24	2.200	5	<b>237252</b>
			50	9	1.050	1.950 - 2.200	24	2.200	5	<b>237253</b>
			55	9	1.050	1.950 - 2.200	24	2.200	5	<b>237254</b>
			65	9	1.050	1.950 - 2.200	24	2.200	5	<b>237255</b>
			70	9	1.050	1.950 - 2.200	24	2.200	5	<b>237256</b>
			80	9	1.050	1.950 - 2.200	24	2.200	5	<b>237257</b>

237304



3.3.1.30 Door lock Z-TF PT with 2 MF-BO E94 U-6x24x6 K+980								L		No
fixed handle height	silver	94	35	9	1.050	1.950 - 2.200	24	2.200	5	<b>237300</b>
			40	9	1.050	1.950 - 2.200	24	2.200	5	<b>237301</b>
			45	9	1.050	1.950 - 2.200	24	2.200	5	<b>237302</b>
			50	9	1.050	1.950 - 2.200	24	2.200	5	<b>237303</b>
			55	9	1.050	1.950 - 2.200	24	2.200	5	<b>237304</b>
			65	9	1.050	1.950 - 2.200	24	2.200	5	<b>237305</b>
			70	9	1.050	1.950 - 2.200	24	2.200	5	<b>237306</b>
			80	9	1.050	1.950 - 2.200	24	2.200	5	<b>237307</b>

3

**MACO  
PROTECT**



## Z-TF Triple Latch Door Lock



## 4 Z-TS Cylinder Operated Door Lock

---

4.1	Hardware overview Z-TS _____	72
4.2	Door lock Z-TS Module with i.S. _____	78
4.3	Door lock Z-TS Module with i.S. + ZS _____	82
4.4	Door lock Z-TS Module PT-M with 2 HO-BO + i.S. _____	83
4.5	Door lock Z-TS Module PT-M with HO-BO _____	84
4.6	Door lock Z-TS Module with HO-BO + ZS _____	94
4.7	Door lock Z-TS Module with HO + i.S. _____	95
4.8	Door lock Z-TS Module with HO _____	96
4.9	Door lock Z-TS Module with HO + ZS _____	101
4.10	Door lock Z-TS Module with BO + i.S. _____	102
4.11	Door lock Z-TS Module with BO _____	103
4.12	Door lock Z-TS Module with BO + ZS _____	109

4 Z-TS Cylinder Operated Door Lock

4.1 Hardware overview Z-TS

3.1m

MACO PROTECT MODULE

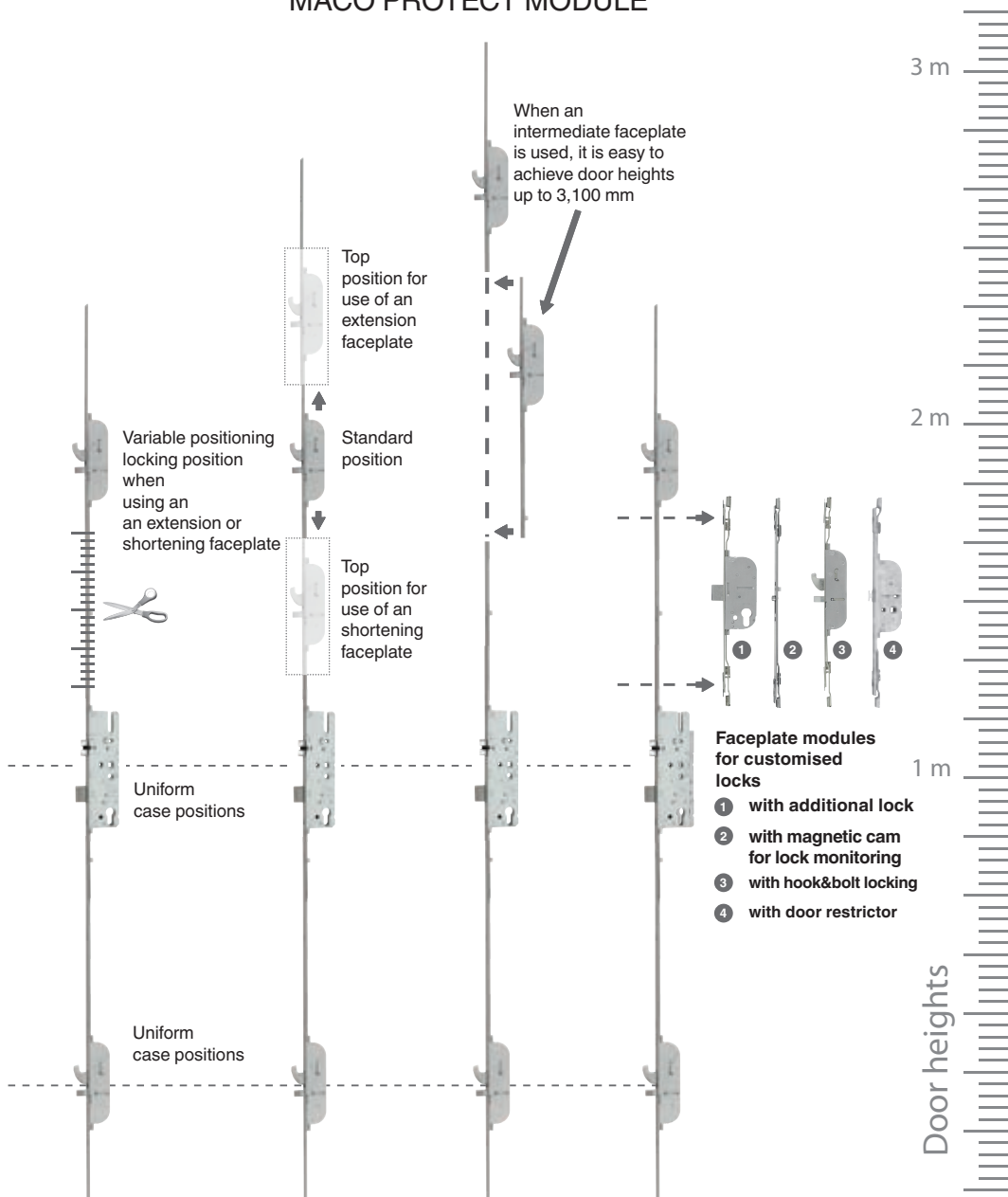

## Single box position

- ① 2 x hook&bolt
- ② 4 x hook&bolt
- ③ 2x hook&bolt + additional lock

4

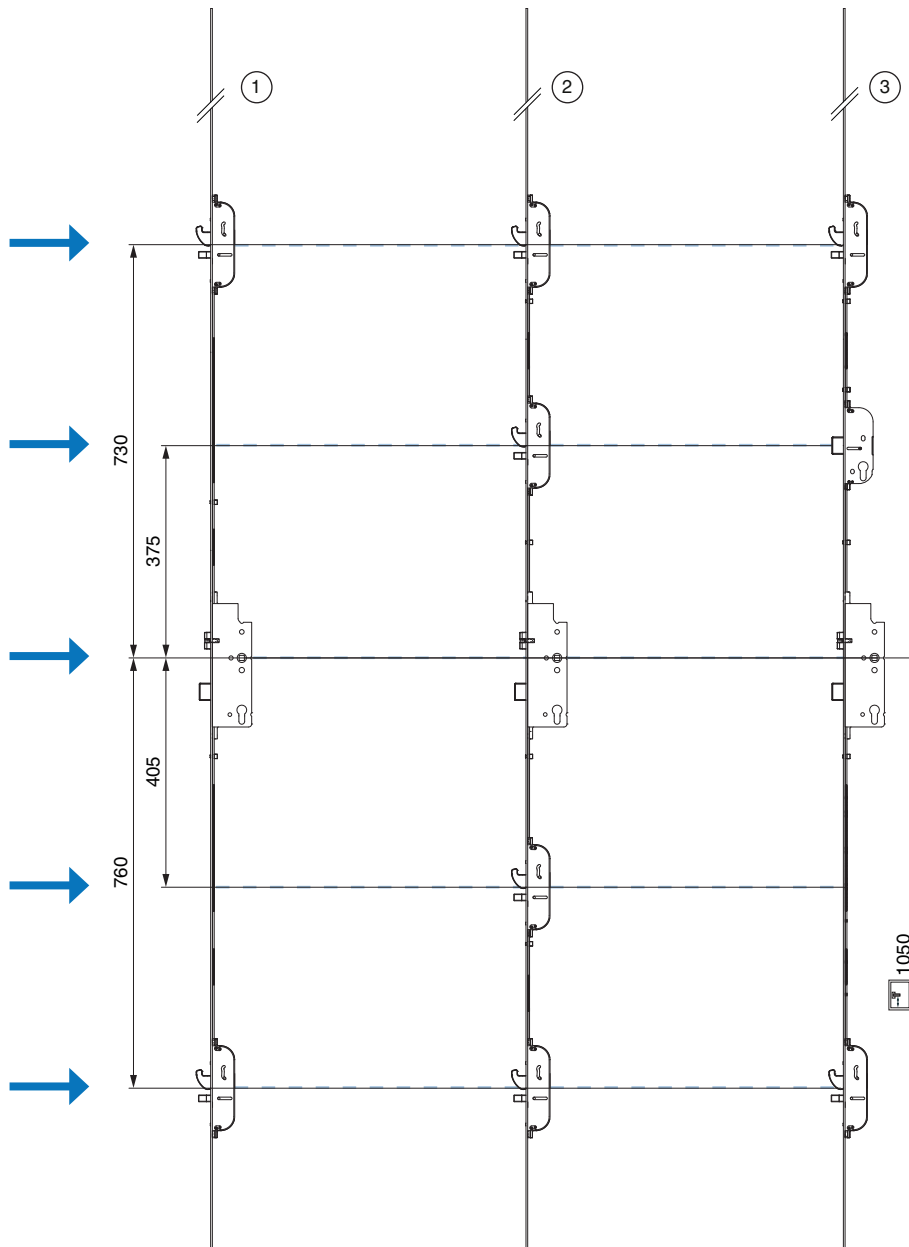

## Variable box position above for hook-bolt

- ① standard lock
- ② shortening faceplate
- ③ extension faceplate

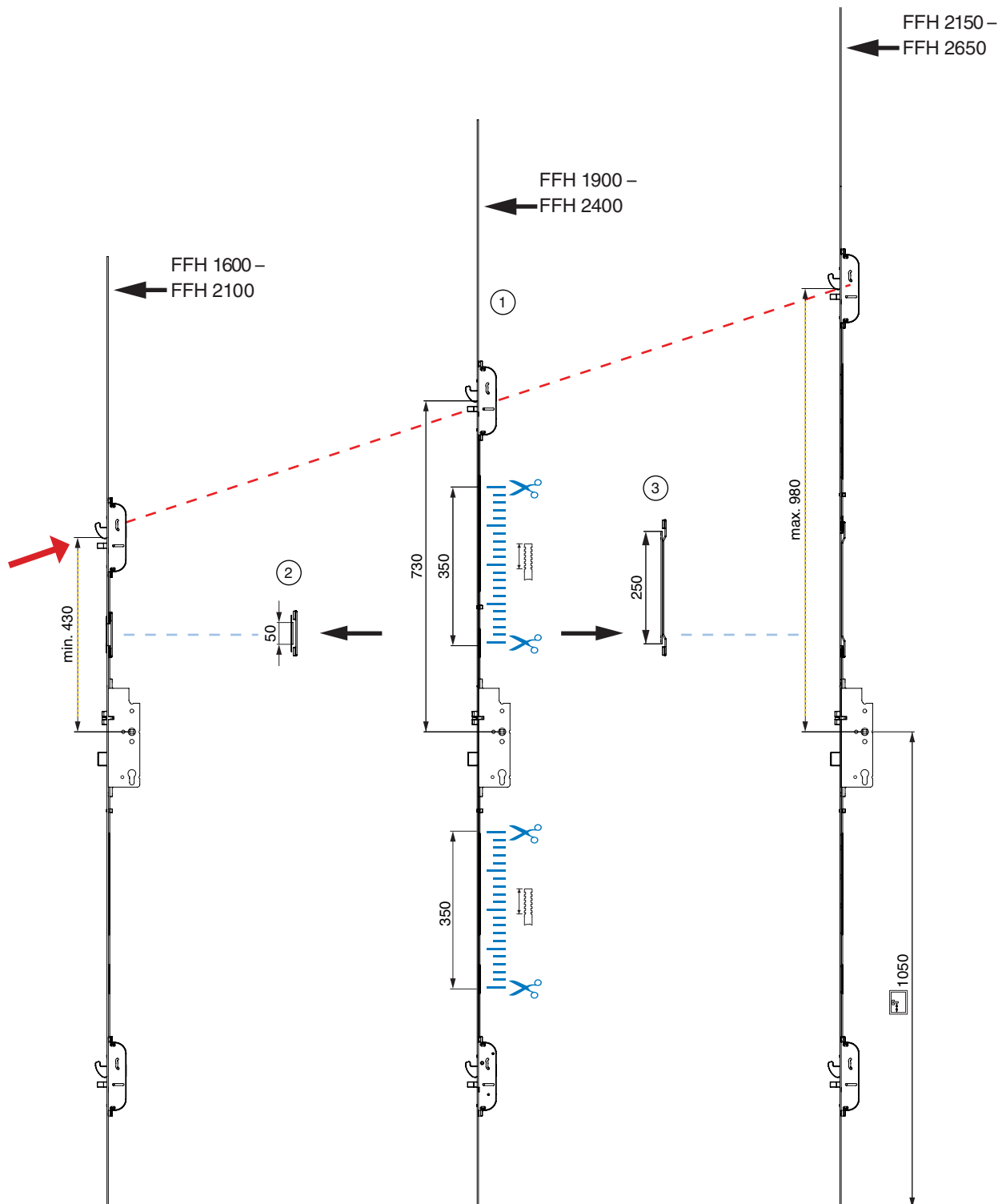

## Variable faceplate module

- ① standard lock
- ② faceplate module ZS
- ③ faceplate module hook&bolt
- ④ faceplate module magnetic cam
- ⑤ faceplate module door restrictor

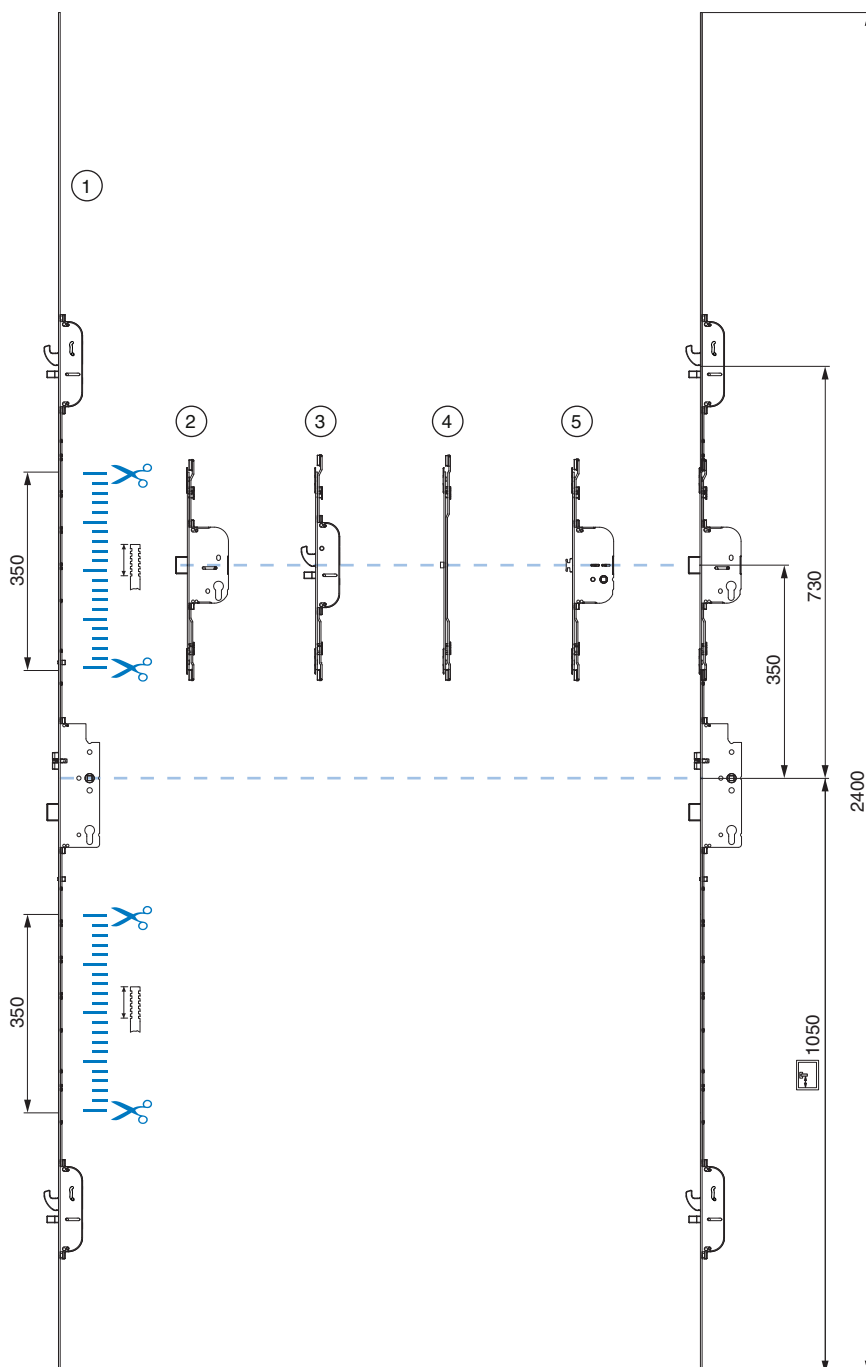



2 hook&bolt  
1- & 2-sashed

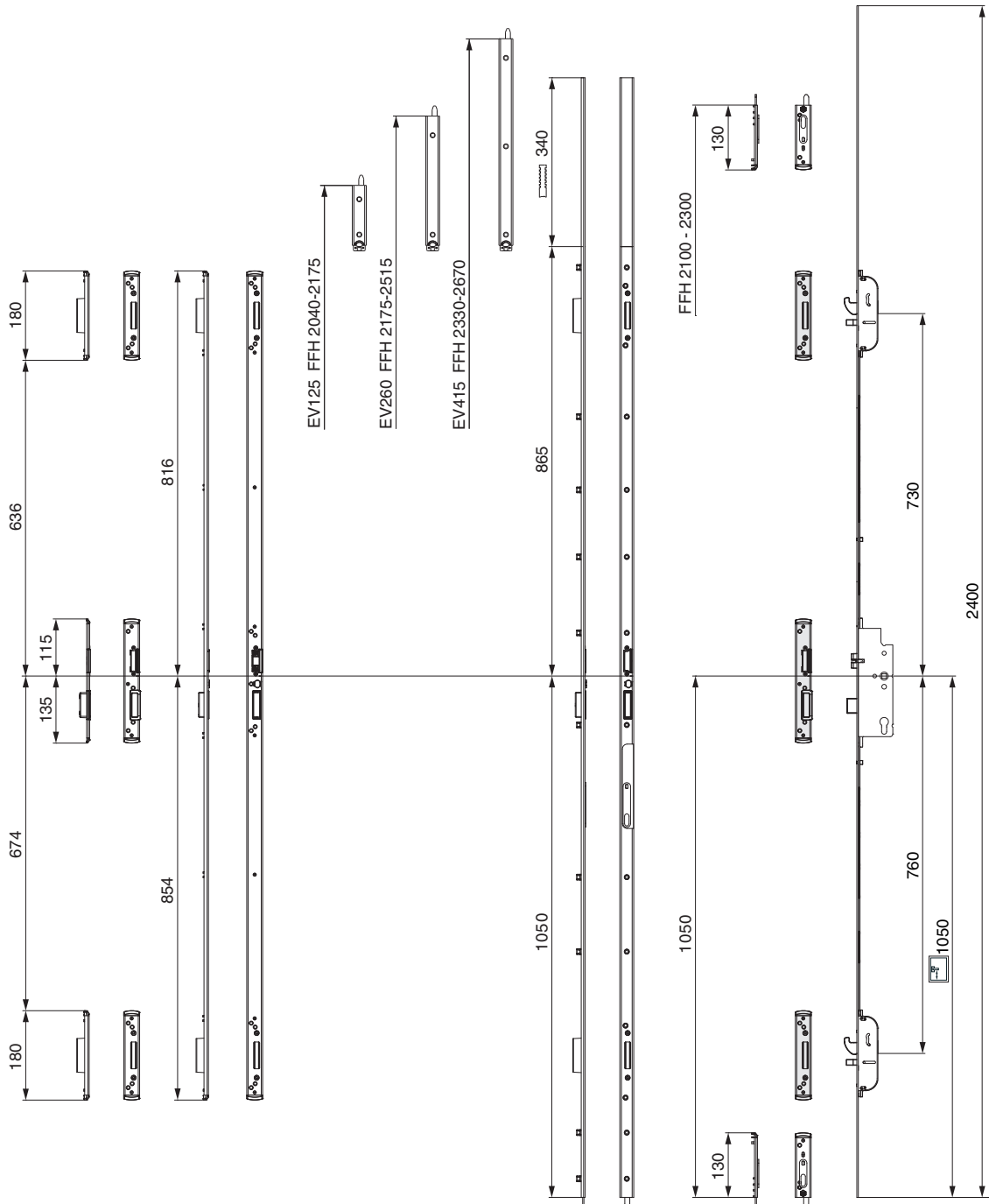



4 i.S.

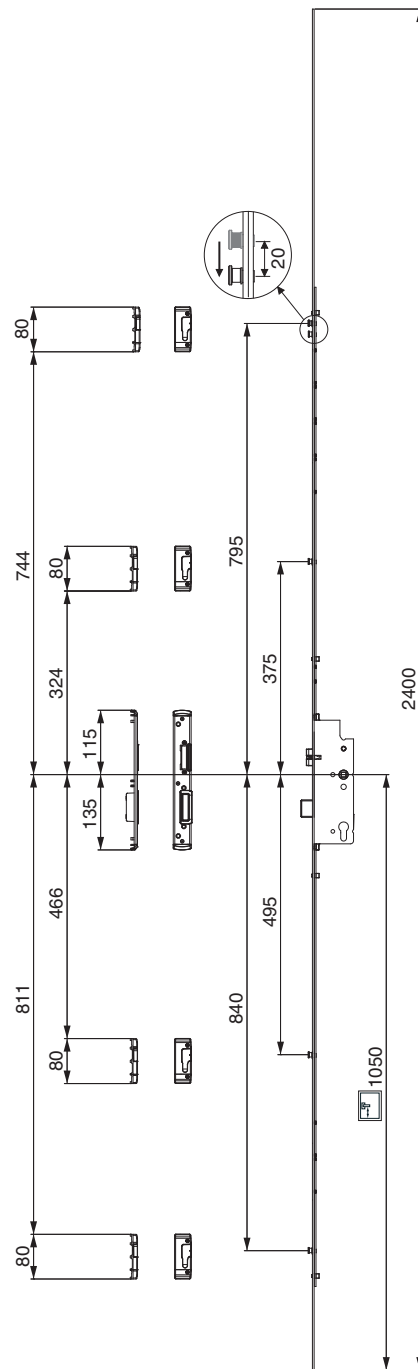







## 4.2 Door lock Z-TS Module with i.S.

### 4.2.1 Door lock Z-TS with 4 i.S.

#### Flat faceplate 16 mm

230694









4.2.1.1 Door lock Z-TS Module PT-M with 4 i.S. E92 F-16								L		No
extendable without deadbolt	silver	92	25	8	1.050	1.950 - 2.400	16	2.400	5	<b>234180</b>
			30	8	1.050	1.950 - 2.400	16	2.400	5	<b>234181</b>
extendable	silver	92	35	8	1.050	1.950 - 2.400	16	2.400	5	<b>230690</b>
				10	1.050	1.950 - 2.400	16	2.400	5	<b>230020</b>
			40	8	1.050	1.950 - 2.400	16	2.400	5	<b>230691</b>
				10	1.050	1.950 - 2.400	16	2.400	5	<b>230021</b>
			45	8	1.050	1.950 - 2.400	16	2.400	5	<b>230692</b>
				10	1.050	1.950 - 2.400	16	2.400	5	<b>230022</b>
			50	8	1.050	1.950 - 2.400	16	2.400	5	<b>230693</b>
				10	1.050	1.950 - 2.400	16	2.400	5	<b>230023</b>
			55	8	1.050	1.950 - 2.400	16	2.400	5	<b>230694</b>
				10	1.050	1.950 - 2.400	16	2.400	5	<b>230024</b>
			65	8	1.050	1.950 - 2.400	16	2.400	5	<b>230695</b>
				10	1.050	1.950 - 2.400	16	2.400	5	<b>230025</b>
			70	8	1.050	1.950 - 2.400	16	2.400	5	<b>230696</b>
				10	1.050	1.950 - 2.400	16	2.400	5	<b>230026</b>
80	8	1.050	1.950 - 2.400	16	2.400	5	<b>230697</b>			
	10	1.050	1.950 - 2.400	16	2.400	5	<b>230027</b>			

#### Flat faceplate 20 mm

230764











4.2.1.2 Door lock Z-TS Module PT-M with 4 i.S. E92 F-20								L		No
extendable without deadbolt	silver	92	25	8	1.050	1.950 - 2.400	20	2.400	5	<b>234182</b>
			30	8	1.050	1.950 - 2.400	20	2.400	5	<b>234183</b>
extendable	silver	92	35	8	1.050	1.950 - 2.400	20	2.400	5	<b>230760</b>
				10	1.050	1.950 - 2.400	20	2.400	5	<b>230260</b>
			40	8	1.050	1.950 - 2.400	20	2.400	5	<b>230761</b>
				10	1.050	1.950 - 2.400	20	2.400	5	<b>230261</b>
			45	8	1.050	1.950 - 2.400	20	2.400	5	<b>230762</b>
				10	1.050	1.950 - 2.400	20	2.400	5	<b>230262</b>
			50	8	1.050	1.950 - 2.400	20	2.400	5	<b>230763</b>
				10	1.050	1.950 - 2.400	20	2.400	5	<b>230263</b>
			55	8	1.050	1.950 - 2.400	20	2.400	5	<b>230764</b>
				10	1.050	1.950 - 2.400	20	2.400	5	<b>230264</b>
			65	8	1.050	1.950 - 2.400	20	2.400	5	<b>230765</b>
				10	1.050	1.950 - 2.400	20	2.400	5	<b>230265</b>
			70	8	1.050	1.950 - 2.400	20	2.400	5	<b>230766</b>
				10	1.050	1.950 - 2.400	20	2.400	5	<b>230266</b>
80	8	1.050	1.950 - 2.400	20	2.400	5	<b>230767</b>			
	10	1.050	1.950 - 2.400	20	2.400	5	<b>230267</b>			

## Flat faceplate 24 mm

231244











4.2.1.3 Door lock Z-TS Module PT-M with 4 i.S. E92 F-24											
		L									No
extendable without deadbolt	silver	92	25	8	1.050	1.950 - 2.400	24	2.400	5		<b>234184</b>
			30	8	1.050	1.950 - 2.400	24	2.400	5		<b>234185</b>
extendable	silver	92	35	8	1.050	1.950 - 2.400	24	2.400	5		<b>231240</b>
				10	1.050	1.950 - 2.400	24	2.400	5		<b>230930</b>
			40	8	1.050	1.950 - 2.400	24	2.400	5		<b>231241</b>
				10	1.050	1.950 - 2.400	24	2.400	5		<b>230931</b>
			45	8	1.050	1.950 - 2.400	24	2.400	5		<b>231242</b>
				10	1.050	1.950 - 2.400	24	2.400	5		<b>230932</b>
			50	8	1.050	1.950 - 2.400	24	2.400	5		<b>231243</b>
				10	1.050	1.950 - 2.400	24	2.400	5		<b>230933</b>
			55	8	1.050	1.950 - 2.400	24	2.400	5		<b>231244</b>
				10	1.050	1.950 - 2.400	24	2.400	5		<b>230934</b>
			65	8	1.050	1.950 - 2.400	24	2.400	5		<b>231245</b>
				10	1.050	1.950 - 2.400	24	2.400	5		<b>230935</b>
70	8	1.050	1.950 - 2.400	24	2.400	5		<b>231246</b>			
	10	1.050	1.950 - 2.400	24	2.400	5		<b>230936</b>			
80	8	1.050	1.950 - 2.400	24	2.400	5		<b>231247</b>			
	10	1.050	1.950 - 2.400	24	2.400	5		<b>230937</b>			

4

## Top hat faceplate 24/16 mm

237604









4.2.1.4 Door lock Z-TS Module PT-M with 4 i.S. E92 F-24/16											
		L									No
extendable	silver	92	35	8	1.050	1.950 - 2.400	24/16	2.400	5		<b>237600</b>
				10	1.050	1.950 - 2.400	24/16	2.400	5		<b>237590</b>
			40	8	1.050	1.950 - 2.400	24/16	2.400	5		<b>237601</b>
				10	1.050	1.950 - 2.400	24/16	2.400	5		<b>237591</b>
			45	8	1.050	1.950 - 2.400	24/16	2.400	5		<b>237602</b>
				10	1.050	1.950 - 2.400	24/16	2.400	5		<b>237592</b>
			50	8	1.050	1.950 - 2.400	24/16	2.400	5		<b>237603</b>
				10	1.050	1.950 - 2.400	24/16	2.400	5		<b>237593</b>
			55	8	1.050	1.950 - 2.400	24/16	2.400	5		<b>237604</b>
				10	1.050	1.950 - 2.400	24/16	2.400	5		<b>237594</b>
			65	8	1.050	1.950 - 2.400	24/16	2.400	5		<b>237605</b>
				10	1.050	1.950 - 2.400	24/16	2.400	5		<b>237595</b>
			70	8	1.050	1.950 - 2.400	24/16	2.400	5		<b>237606</b>
				10	1.050	1.950 - 2.400	24/16	2.400	5		<b>237596</b>
			80	8	1.050	1.950 - 2.400	24/16	2.400	5		<b>237607</b>
				10	1.050	1.950 - 2.400	24/16	2.400	5		<b>237597</b>

## Flat faceplate 16 mm

230014









4.2.1.5 Door lock Z-TS Module PT-M with 4 i.S. E88 F-16									No	
extendable	silver	88	35	8,5	1.050	1.950 - 2.400	16	2.400	5	<b>230010</b>
			40	8,5	1.050	1.950 - 2.400	16	2.400	5	<b>230011</b>
			45	8,5	1.050	1.950 - 2.400	16	2.400	5	<b>230012</b>
			50	8,5	1.050	1.950 - 2.400	16	2.400	5	<b>230013</b>
			55	8,5	1.050	1.950 - 2.400	16	2.400	5	<b>230014</b>
			65	8,5	1.050	1.950 - 2.400	16	2.400	5	<b>230015</b>
			70	8,5	1.050	1.950 - 2.400	16	2.400	5	<b>230016</b>
			80	8,5	1.050	1.950 - 2.400	16	2.400	5	<b>230017</b>

## Flat faceplate 20 mm

230254









4.2.1.6 Door lock Z-TS Module PT-M with 4 i.S. E88 F-20									No	
extendable	silver	88	35	8,5	1.050	1.950 - 2.400	20	2.400	5	<b>230250</b>
			40	8,5	1.050	1.950 - 2.400	20	2.400	5	<b>230251</b>
			45	8,5	1.050	1.950 - 2.400	20	2.400	5	<b>230252</b>
			50	8,5	1.050	1.950 - 2.400	20	2.400	5	<b>230253</b>
			55	8,5	1.050	1.950 - 2.400	20	2.400	5	<b>230254</b>
			65	8,5	1.050	1.950 - 2.400	20	2.400	5	<b>230255</b>
			70	8,5	1.050	1.950 - 2.400	20	2.400	5	<b>230256</b>
			80	8,5	1.050	1.950 - 2.400	20	2.400	5	<b>230257</b>

## Flat faceplate 16 mm

236004









4.2.1.7 Door lock Z-TS Module PT-M with 4 i.S. E94 F-16									No	
extendable	silver	94	35	9	1.050	1.950 - 2.400	16	2.400	5	<b>236000</b>
			40	9	1.050	1.950 - 2.400	16	2.400	5	<b>236001</b>
			45	9	1.050	1.950 - 2.400	16	2.400	5	<b>236002</b>
			50	9	1.050	1.950 - 2.400	16	2.400	5	<b>236003</b>
			55	9	1.050	1.950 - 2.400	16	2.400	5	<b>236004</b>
			65	9	1.050	1.950 - 2.400	16	2.400	5	<b>236005</b>
			70	9	1.050	1.950 - 2.400	16	2.400	5	<b>236006</b>
			80	9	1.050	1.950 - 2.400	16	2.400	5	<b>236007</b>

## Flat faceplate 20 mm

236034









4.2.1.8 Door lock Z-TS Module PT-M with 4 i.S. E94 F-20								L		No
extendable	silver	94	35	9	1.050	1.950 - 2.400	20	2.400	5	<b>236030</b>
			40	9	1.050	1.950 - 2.400	20	2.400	5	<b>236031</b>
			45	9	1.050	1.950 - 2.400	20	2.400	5	<b>236032</b>
			50	9	1.050	1.950 - 2.400	20	2.400	5	<b>236033</b>
			55	9	1.050	1.950 - 2.400	20	2.400	5	<b>236034</b>
			65	9	1.050	1.950 - 2.400	20	2.400	5	<b>236035</b>
			70	9	1.050	1.950 - 2.400	20	2.400	5	<b>236036</b>
			80	9	1.050	1.950 - 2.400	20	2.400	5	<b>236037</b>

4

## Top hat faceplate 24/16 mm

237144



4.2.1.9 Door lock Z-TS Module PT-M with 4 i.S. E94 F-24/16								L		No
extendable	silver	94	35	9	1.050	1.950 - 2.400	24/16	2.400	5	<b>237140</b>
			40	9	1.050	1.950 - 2.400	24/16	2.400	5	<b>237141</b>
			45	9	1.050	1.950 - 2.400	24/16	2.400	5	<b>237142</b>
			50	9	1.050	1.950 - 2.400	24/16	2.400	5	<b>237143</b>
			55	9	1.050	1.950 - 2.400	24/16	2.400	5	<b>237144</b>
			65	9	1.050	1.950 - 2.400	24/16	2.400	5	<b>237145</b>
			70	9	1.050	1.950 - 2.400	24/16	2.400	5	<b>237146</b>
			80	9	1.050	1.950 - 2.400	24/16	2.400	5	<b>237147</b>

## 4.3 Door lock Z-TS Module with i.S. + ZS











### 4.3.1 Door lock Z-TS with 3 i.S. + ZS

#### Flat faceplate 16 mm

231424



#### 4.3.1.1 Door lock Z-TS Module PT-M with 3 i.S. + ZS E92 F-16









											
extendable	silver	92	35	8	1.050	1.950 - 2.400	16	2.400	5	<b>231420</b>	
				10	1.050	1.950 - 2.400	16	2.400	5	<b>231430</b>	
				40	1.050	1.950 - 2.400	16	2.400	5	<b>231421</b>	
				10	1.050	1.950 - 2.400	16	2.400	5	<b>231431</b>	
				45	1.050	1.950 - 2.400	16	2.400	5	<b>231422</b>	
				10	1.050	1.950 - 2.400	16	2.400	5	<b>231432</b>	
				50	1.050	1.950 - 2.400	16	2.400	5	<b>231423</b>	
				10	1.050	1.950 - 2.400	16	2.400	5	<b>231433</b>	
				55	1.050	1.950 - 2.400	16	2.400	5	<b>231424</b>	
				10	1.050	1.950 - 2.400	16	2.400	5	<b>231434</b>	
				65	1.050	1.950 - 2.400	16	2.400	5	<b>231425</b>	
				10	1.050	1.950 - 2.400	16	2.400	5	<b>231435</b>	
				70	1.050	1.950 - 2.400	16	2.400	5	<b>231426</b>	
				10	1.050	1.950 - 2.400	16	2.400	5	<b>231436</b>	
				80	1.050	1.950 - 2.400	16	2.400	5	<b>231427</b>	
				10	1.050	1.950 - 2.400	16	2.400	5	<b>231437</b>	

#### Flat faceplate 20 mm

231464



#### 4.3.1.2 Door lock Z-TS Module PT-M with 3 i.S. + ZS E92 F-20

										
extendable	silver	92	35	8	1.050	1.950 - 2.400	20	2.400	5	<b>231460</b>
				10	1.050	1.950 - 2.400	20	2.400	5	<b>231470</b>
				40	1.050	1.950 - 2.400	20	2.400	5	<b>231461</b>
				10	1.050	1.950 - 2.400	20	2.400	5	<b>231471</b>
				45	1.050	1.950 - 2.400	20	2.400	5	<b>231462</b>
				10	1.050	1.950 - 2.400	20	2.400	5	<b>231472</b>
				50	1.050	1.950 - 2.400	20	2.400	5	<b>231463</b>
				10	1.050	1.950 - 2.400	20	2.400	5	<b>231473</b>
				55	1.050	1.950 - 2.400	20	2.400	5	<b>231464</b>
				10	1.050	1.950 - 2.400	20	2.400	5	<b>231474</b>
				65	1.050	1.950 - 2.400	20	2.400	5	<b>231465</b>
				10	1.050	1.950 - 2.400	20	2.400	5	<b>231475</b>
				70	1.050	1.950 - 2.400	20	2.400	5	<b>231466</b>
				10	1.050	1.950 - 2.400	20	2.400	5	<b>231476</b>
				80	1.050	1.950 - 2.400	20	2.400	5	<b>231467</b>
				10	1.050	1.950 - 2.400	20	2.400	5	<b>231477</b>

## 4.4 Door lock Z-TS Module PT-M with 2 HO-BO + i.S.

### 4.4.1 Door lock Z-TS with 2HO-BO and 2i.S.

Flat faceplate 16 mm

238564



#### 4.4.1.1 Door lock Z-TS Module PT-M with 2 HO-BO and 2i.S. E92 F-16



modular	silver	92	35	8	1.050	1.950 - 2.400	16	2.400	5	<b>No</b>
				10	1.050	1.950 - 2.400	16	2.400	5	<b>238560</b>
			40	8	1.050	1.950 - 2.400	16	2.400	5	<b>238561</b>
				10	1.050	1.950 - 2.400	16	2.400	5	<b>238571</b>
			45	8	1.050	1.950 - 2.400	16	2.400	5	<b>238562</b>
				10	1.050	1.950 - 2.400	16	2.400	5	<b>238572</b>
			50	8	1.050	1.950 - 2.400	16	2.400	5	<b>238563</b>
				10	1.050	1.950 - 2.400	16	2.400	5	<b>238573</b>
			55	8	1.050	1.950 - 2.400	16	2.400	5	<b>238564</b>
				10	1.050	1.950 - 2.400	16	2.400	5	<b>238574</b>
			65	8	1.050	1.950 - 2.400	16	2.400	5	<b>238565</b>
				10	1.050	1.950 - 2.400	16	2.400	5	<b>238575</b>
			70	8	1.050	1.950 - 2.400	16	2.400	5	<b>238566</b>
				10	1.050	1.950 - 2.400	16	2.400	5	<b>238576</b>
			80	8	1.050	1.950 - 2.400	16	2.400	5	<b>238567</b>
				10	1.050	1.950 - 2.400	16	2.400	5	<b>238577</b>

Flat faceplate 20 mm

238714



#### 4.4.1.2 Door lock Z-TS Module PT-M with 2 HO-BO + 2i.S. E92 F-20



modular	silver	92	35	8	1.050	1.950 - 2.400	20	2.400	5	<b>No</b>
				10	1.050	1.950 - 2.400	20	2.400	5	<b>238710</b>
			40	8	1.050	1.950 - 2.400	20	2.400	5	<b>238711</b>
				10	1.050	1.950 - 2.400	20	2.400	5	<b>238721</b>
			45	8	1.050	1.950 - 2.400	20	2.400	5	<b>238712</b>
				10	1.050	1.950 - 2.400	20	2.400	5	<b>238722</b>
			50	8	1.050	1.950 - 2.400	20	2.400	5	<b>238713</b>
				10	1.050	1.950 - 2.400	20	2.400	5	<b>238723</b>
			55	8	1.050	1.950 - 2.400	20	2.400	5	<b>238714</b>
				10	1.050	1.950 - 2.400	20	2.400	5	<b>238724</b>
			65	8	1.050	1.950 - 2.400	20	2.400	5	<b>238715</b>
				10	1.050	1.950 - 2.400	20	2.400	5	<b>238725</b>
			70	8	1.050	1.950 - 2.400	20	2.400	5	<b>238716</b>
				10	1.050	1.950 - 2.400	20	2.400	5	<b>238726</b>
			80	8	1.050	1.950 - 2.400	20	2.400	5	<b>238717</b>
				10	1.050	1.950 - 2.400	20	2.400	5	<b>238727</b>

## 4.5 Door lock Z-TS Module PT-M with HO-BO







### 4.5.1 Door lock Z-TS with 2HO-BO

Flat faceplate 16 mm

235814



#### 4.5.1.1 Door lock Z-TS Module PT-M with 2 HO-BO E92 F-16







								<b>L</b>		<b>No</b>
modular	silver	92	35	8	1.050	1.950 - 2.400	16	2.400	5	<b>235810</b>
				10	1.050	1.950 - 2.400	16	2.400	5	<b>235820</b>
			40	8	1.050	1.950 - 2.400	16	2.400	5	<b>235811</b>
				10	1.050	1.950 - 2.400	16	2.400	5	<b>235821</b>
			45	8	1.050	1.950 - 2.400	16	2.400	5	<b>235812</b>
				10	1.050	1.950 - 2.400	16	2.400	5	<b>235822</b>
			50	8	1.050	1.950 - 2.400	16	2.400	5	<b>235813</b>
				10	1.050	1.950 - 2.400	16	2.400	5	<b>235823</b>
			55	8	1.050	1.950 - 2.400	16	2.400	5	<b>235814</b>
				10	1.050	1.950 - 2.400	16	2.400	5	<b>235824</b>
			65	8	1.050	1.950 - 2.400	16	2.400	5	<b>235815</b>
				10	1.050	1.950 - 2.400	16	2.400	5	<b>235825</b>
			70	8	1.050	1.950 - 2.400	16	2.400	5	<b>235816</b>
				10	1.050	1.950 - 2.400	16	2.400	5	<b>235826</b>
			80	8	1.050	1.950 - 2.400	16	2.400	5	<b>235817</b>
				10	1.050	1.950 - 2.400	16	2.400	5	<b>235827</b>

Flat faceplate 20 mm

235854



#### 4.5.1.2 Door lock Z-TS Module PT-M with 2 HO-BO E92 F-20

								<b>L</b>		<b>No</b>
modular	silver	92	35	8	1.050	1.900 - 2.400	20	2.400	5	<b>235850</b>
				10	1.050	1.900 - 2.400	20	2.400	5	<b>235860</b>
			40	8	1.050	1.900 - 2.400	20	2.400	5	<b>235851</b>
				10	1.050	1.900 - 2.400	20	2.400	5	<b>235861</b>
			45	8	1.050	1.900 - 2.400	20	2.400	5	<b>235852</b>
				10	1.050	1.900 - 2.400	20	2.400	5	<b>235862</b>
			50	8	1.050	1.900 - 2.400	20	2.400	5	<b>235853</b>
				10	1.050	1.900 - 2.400	20	2.400	5	<b>235863</b>
			55	8	1.050	1.900 - 2.400	20	2.400	5	<b>235854</b>
				10	1.050	1.900 - 2.400	20	2.400	5	<b>235864</b>
			65	8	1.050	1.900 - 2.400	20	2.400	5	<b>235855</b>
				10	1.050	1.900 - 2.400	20	2.400	5	<b>235865</b>
			70	8	1.050	1.900 - 2.400	20	2.400	5	<b>235856</b>
				10	1.050	1.900 - 2.400	20	2.400	5	<b>235866</b>
			80	8	1.050	1.900 - 2.400	20	2.400	5	<b>235857</b>
				10	1.050	1.900 - 2.400	20	2.400	5	<b>235867</b>

244602



**4.5.1.3 Door lock Varia Z-TS Module PT-M with 2 HO-BO E92 R20 HH890**



fixed handle height	silver	92	35	8	1.300	1.950 - 2.400	20 / R	1.750	5	<b>244600</b>
			45	8	1.300	1.950 - 2.400	20 / R	1.750	5	<b>244602</b>

**Flat faceplate 24 mm**

235894



**4.5.1.4 Door lock Z-TS Module PT-M with 2 HO-BO E92 F-24**



modular	silver	92	35	8	1.050	1.950 - 2.400	24	2.400	5	<b>235890</b>
				10	1.050	1.950 - 2.400	24	2.400	5	<b>235900</b>
			40	8	1.050	1.950 - 2.400	24	2.400	5	<b>235891</b>
				10	1.050	1.950 - 2.400	24	2.400	5	<b>235901</b>
			45	8	1.050	1.950 - 2.400	24	2.400	5	<b>235892</b>
				10	1.050	1.950 - 2.400	24	2.400	5	<b>235902</b>
			50	8	1.050	1.950 - 2.400	24	2.400	5	<b>235893</b>
				10	1.050	1.950 - 2.400	24	2.400	5	<b>235903</b>
			55	8	1.050	1.950 - 2.400	24	2.400	5	<b>235894</b>
				10	1.050	1.950 - 2.400	24	2.400	5	<b>235904</b>
			65	8	1.050	1.950 - 2.400	24	2.400	5	<b>235895</b>
				10	1.050	1.950 - 2.400	24	2.400	5	<b>235905</b>
			70	8	1.050	1.950 - 2.400	24	2.400	5	<b>235896</b>
				10	1.050	1.950 - 2.400	24	2.400	5	<b>235906</b>
			80	8	1.050	1.950 - 2.400	24	2.400	5	<b>235897</b>
				10	1.050	1.950 - 2.400	24	2.400	5	<b>235907</b>

**Top hat faceplate 24/16 mm**

237624



**4.5.1.5 Door lock Z-TS Module PT-M with 2 HO-BO E92 F-24/16**







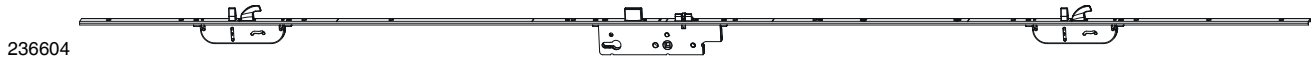

modular	silver	92	35	8	1.050	1.950 - 2.400	24/16	2.400	5	<b>237620</b>
				10	1.050	1.950 - 2.400	24/16	2.400	5	<b>237630</b>
			40	8	1.050	1.950 - 2.400	24/16	2.400	5	<b>237621</b>
				10	1.050	1.950 - 2.400	24/16	2.400	5	<b>237631</b>
			45	8	1.050	1.950 - 2.400	24/16	2.400	5	<b>237622</b>
				10	1.050	1.900 - 2.400	24/16	2.400	5	<b>237632</b>
			50	8	1.050	1.950 - 2.400	24/16	2.400	5	<b>237623</b>
				10	1.050	1.950 - 2.400	24/16	2.400	5	<b>237633</b>
			55	8	1.050	1.950 - 2.400	24/16	2.400	5	<b>237624</b>
				10	1.050	1.950 - 2.400	24/16	2.400	5	<b>237634</b>
			65	8	1.050	1.950 - 2.400	24/16	2.400	5	<b>237625</b>
				10	1.050	1.950 - 2.400	24/16	2.400	5	<b>237635</b>
			70	8	1.050	1.950 - 2.400	24/16	2.400	5	<b>237626</b>
				10	1.050	1.950 - 2.400	24/16	2.400	5	<b>237636</b>
			80	8	1.050	1.950 - 2.400	24/16	2.400	5	<b>237627</b>
				10	1.050	1.950 - 2.400	24/16	2.400	5	<b>237637</b>

## U-faceplate 6x24x6 mm









236604

<b>4.5.1.6 Door lock Z-TS Module PT-M with 2 HO-BO E92 U-6x24x6</b>								<b>L</b>		<b>No</b>
modular	silver	92	35	8	1.050	1.950 - 2.200	24	2.200	5	<b>236600</b>
				10	1.050	1.950 - 2.200	24	2.200	5	<b>236590</b>
			40	8	1.050	1.950 - 2.200	24	2.200	5	<b>236601</b>
				10	1.050	1.950 - 2.200	24	2.200	5	<b>236591</b>
			45	8	1.050	1.950 - 2.200	24	2.200	5	<b>236602</b>
				10	1.050	1.950 - 2.200	24	2.200	5	<b>236592</b>
			50	8	1.050	1.950 - 2.200	24	2.200	5	<b>236603</b>
				10	1.050	1.950 - 2.200	24	2.200	5	<b>236593</b>
			55	8	1.050	1.950 - 2.200	24	2.200	5	<b>236604</b>
				10	1.050	1.950 - 2.200	24	2.200	5	<b>236594</b>
			65	8	1.050	1.950 - 2.200	24	2.200	5	<b>236605</b>
				10	1.050	1.950 - 2.200	24	2.200	5	<b>236595</b>
			70	8	1.050	1.950 - 2.200	24	2.200	5	<b>236606</b>
				10	1.050	1.950 - 2.200	24	2.200	5	<b>236596</b>
			80	8	1.050	1.950 - 2.200	24	2.200	5	<b>236607</b>
				10	1.050	1.950 - 2.200	24	2.200	5	<b>236597</b>







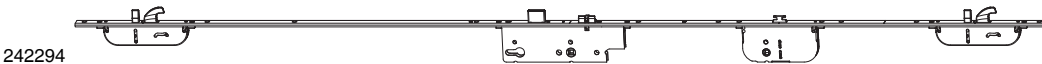

242724

<b>4.5.1.7 Door lock Z-TS Module PT-M with 2 HO-BO E92 U-6x24x6 HH885</b>								<b>L</b>		<b>No</b>
modular	silver	92	35	8	885	1.500 - 1.800	24	1.740	5	<b>242720</b>
				10	885	1.500 - 1.800	24	1.740	5	<b>242730</b>
			40	8	885	1.500 - 1.800	24	1.740	5	<b>242721</b>
				10	885	1.500 - 1.800	24	1.740	5	<b>242731</b>
			45	8	885	1.500 - 1.800	24	1.740	5	<b>242722</b>
				10	885	1.500 - 1.800	24	1.740	5	<b>242732</b>
			50	8	885	1.500 - 1.800	24	1.740	5	<b>242723</b>
				10	885	1.500 - 1.800	24	1.740	5	<b>242733</b>
			55	8	885	1.500 - 1.800	24	1.740	5	<b>242724</b>
				10	885	1.500 - 1.800	24	1.740	5	<b>242734</b>









242294

<b>4.5.1.8 Door lock Z-TS Module PT-M with 2 HO-BO E92 U-6x24x6 HH885 and door turn-restrictor</b>								<b>L</b>		<b>No</b>
fixed handle height	silver	92	35	8	885	2.000 - 2.200	24	1.740	5	<b>242290</b>
				10	885	2.000 - 2.200	24	1.740	5	<b>242300</b>
			40	8	885	2.000 - 2.200	24	1.740	5	<b>242291</b>
				10	885	2.000 - 2.200	24	1.740	5	<b>242301</b>
			45	8	885	2.000 - 2.200	24	1.740	5	<b>242292</b>
				10	885	2.000 - 2.200	24	1.740	5	<b>242302</b>
			50	8	885	2.000 - 2.200	24	1.740	5	<b>242293</b>
				10	885	2.000 - 2.200	24	1.740	5	<b>242303</b>
			55	8	885	2.000 - 2.200	24	1.740	5	<b>242294</b>
				10	885	2.000 - 2.200	24	1.740	5	<b>242304</b>







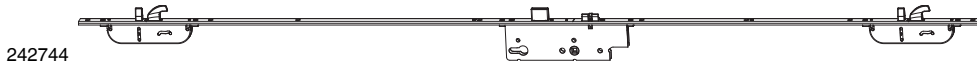

242114

<b>4.5.1.9 Door lock Z-TS Module PT-M with 2 HO-BO E92 U-6x24x6 K+375 HH885</b>								<b>L</b>		<b>No</b>
fixed handle height	silver	92	35	8	885	1.500 - 1.800	24	1.385	5	<b>242110</b>
				10	885	1.500 - 1.800	24	1.385	5	<b>242120</b>
			40	8	885	1.500 - 1.800	24	1.385	5	<b>242111</b>
				10	885	1.500 - 1.800	24	1.385	5	<b>242121</b>
			45	8	885	1.500 - 1.800	24	1.385	5	<b>242112</b>
				10	885	1.500 - 1.800	24	1.385	5	<b>242122</b>
		50	8	885	1.500 - 1.800	24	1.385	5	<b>242113</b>	
			10	885	1.500 - 1.800	24	1.385	5	<b>242123</b>	
		55	8	885	1.500 - 1.800	24	1.385	5	<b>242114</b>	
			10	885	1.500 - 1.800	24	1.385	5	<b>242124</b>	

4







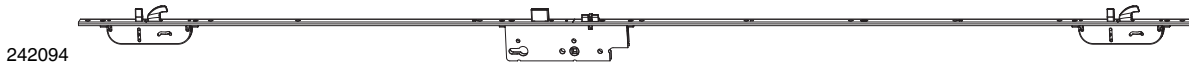

242744

<b>4.5.1.10 Door lock Z-TS Module PT-M with 2 HO-BO E92 U-6x24x6 K+605 HH885</b>								<b>L</b>		<b>No</b>
fixed handle height	silver	92	35	8	885	1.800 - 2.000	24	1.615	5	<b>242740</b>
				10	885	1.800 - 2.000	24	1.615	5	<b>242750</b>
			40	8	885	1.800 - 2.000	24	1.615	5	<b>242741</b>
				10	885	1.800 - 2.000	24	1.615	5	<b>242751</b>
			45	8	885	1.800 - 2.000	24	1.615	5	<b>242742</b>
				10	885	1.800 - 2.000	24	1.615	5	<b>242752</b>
		50	8	885	1.800 - 2.000	24	1.615	5	<b>242743</b>	
			10	885	1.800 - 2.000	24	1.615	5	<b>242753</b>	
		55	8	885	1.800 - 2.000	24	1.615	5	<b>242744</b>	
			10	885	1.800 - 2.000	24	1.615	5	<b>242754</b>	









242094

<b>4.5.1.11 Door lock Z-TS Module PT-M with 2 HO-BO E92 U-6x24x6 K+980 HH885</b>								<b>L</b>		<b>No</b>
fixed handle height	silver	92	35	8	885	2.200 - 2.400	24	1.990	5	<b>242090</b>
				10	885	2.200 - 2.400	24	1.990	5	<b>242100</b>
			40	8	885	2.200 - 2.400	24	1.990	5	<b>242091</b>
				10	885	2.200 - 2.400	24	1.990	5	<b>242101</b>
			45	8	885	2.200 - 2.400	24	1.990	5	<b>242092</b>
				10	885	2.200 - 2.400	24	1.990	5	<b>242102</b>
		50	8	885	2.200 - 2.400	24	1.990	5	<b>242093</b>	
			10	885	2.200 - 2.400	24	1.990	5	<b>242103</b>	
		55	8	885	2.200 - 2.400	24	1.990	5	<b>242094</b>	
			10	885	2.200 - 2.400	24	1.990	5	<b>242104</b>	

## Flat faceplate 16 mm

235804









4.5.1.12 Door lock Z-TS Module PT-M with 2 HO-BO E88 F-16							<b>L</b>		<b>No</b>	
modular	silver	88	35	8,5	1.050	1.950 - 2.400	16	2.400	5	<b>235800</b>
			40	8,5	1.050	1.950 - 2.400	16	2.400	5	<b>235801</b>
			45	8,5	1.050	1.950 - 2.400	16	2.400	5	<b>235802</b>
			50	8,5	1.050	1.950 - 2.400	16	2.400	5	<b>235803</b>
			55	8,5	1.050	1.950 - 2.400	16	2.400	5	<b>235804</b>
			65	8,5	1.050	1.950 - 2.400	16	2.400	5	<b>235805</b>
			70	8,5	1.050	1.950 - 2.400	16	2.400	5	<b>235806</b>
			80	8,5	1.050	1.950 - 2.400	16	2.400	5	<b>235807</b>

## Flat faceplate 20 mm

235844









4.5.1.13 Door lock Z-TS Module PT-M with 2 HO-BO E88 F-20							<b>L</b>		<b>No</b>	
modular	silver	88	35	8,5	1.050	1.950 - 2.400	20	2.400	5	<b>235840</b>
			40	8,5	1.050	1.950 - 2.400	20	2.400	5	<b>235841</b>
			45	8,5	1.050	1.950 - 2.400	20	2.400	5	<b>235842</b>
			50	8,5	1.050	1.950 - 2.400	20	2.400	5	<b>235843</b>
			55	8,5	1.050	1.950 - 2.400	20	2.400	5	<b>235844</b>
			65	8,5	1.050	1.950 - 2.400	20	2.400	5	<b>235845</b>
			70	8,5	1.050	1.950 - 2.400	20	2.400	5	<b>235846</b>
			80	8,5	1.050	1.950 - 2.400	20	2.400	5	<b>235847</b>

## Flat faceplate 16 mm

236014









4.5.1.14 Door lock Z-TS Module PT-M with 2 HO-BO E94 F-16							<b>L</b>		<b>No</b>									
modular	silver	94	35	9	1.050	1.950 - 2.400	16	2.400	5	<b>236010</b>								
			40	9	1.050	1.950 - 2.400	16	2.400	5	<b>236011</b>								
			45	9	1.050	1.950 - 2.400	16	2.400	5	<b>236012</b>								
			50	9	1.050	1.950 - 2.400	16	2.400	5	<b>236013</b>								
			55	9	1.050	1.950 - 2.400	16	2.400	5	<b>236014</b>								
			65	8	1.050	1.950 - 2.400	16	2.400	5	5	<b>235925</b>							
												9	1.050	1.950 - 2.400	16	2.400	5	<b>236015</b>
												70	9	1.050	1.950 - 2.400	16	2.400	5
			80	9	1.050	1.950 - 2.400	16	2.400	5	<b>236017</b>								

## Flat faceplate 20 mm

236024









4.5.1.15 Door lock Z-TS Module PT-M with 2 HO-BO E94 F-20								L		No
modular	silver	94	35	9	1.050	1.950 - 2.400	20	2.400	5	<b>236020</b>
			40	9	1.050	1.950 - 2.400	20	2.400	5	<b>236021</b>
			45	9	1.050	1.950 - 2.400	20	2.400	5	<b>236022</b>
			50	9	1.050	1.950 - 2.400	20	2.400	5	<b>236023</b>
			55	9	1.050	1.950 - 2.400	20	2.400	5	<b>236024</b>
			65	9	1.050	1.950 - 2.400	20	2.400	5	<b>236025</b>
			70	9	1.050	1.950 - 2.400	20	2.400	5	<b>236026</b>
			80	9	1.050	1.950 - 2.400	20	2.400	5	<b>236027</b>

4

## Top hat faceplate 24/16 mm

240464







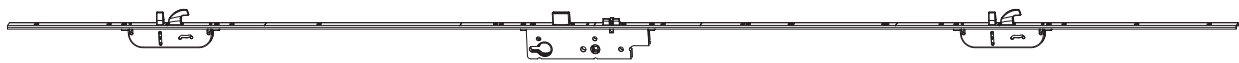

4.5.1.16 Door lock Z-TS Module PT-M with 2 HO-BO E94 F-24/16							L		No	
modular	silver	94	35	9	1.050	1.900 - 2.400	24/16	2.400	5	<b>240460</b>
			40	9	1.050	1.900 - 2.400	24/16	2.400	5	<b>240461</b>
			45	9	1.050	1.900 - 2.400	24/16	2.400	5	<b>240462</b>
			50	9	1.050	1.900 - 2.400	24/16	2.400	5	<b>240463</b>
			55	9	1.050	1.900 - 2.400	24/16	2.400	5	<b>240464</b>
			65	9	1.050	1.900 - 2.400	24/16	2.400	5	<b>240465</b>
			70	9	1.050	1.900 - 2.400	24/16	2.400	5	<b>240466</b>
			80	9	1.050	1.900 - 2.400	24/16	2.400	5	<b>240467</b>

## U-faceplate 6x24x6 mm

238462









4.5.1.17 Door lock Z-TS Module PT-M with 2 HO-BO E94 U-6x24x6							L		No	
modular	silver	94	45	9	1.050	1.950 - 2.200	24	2.200	5	<b>238462</b>

## 4.5.2 Door lock Z-TS with 4 HO-BO

### Flat faceplate 16 mm

234004









4.5.2.1 Door lock Z-TS Module PT-M with 4 HO-BO E92 F-16								L		No
modular	silver	92	35	8	1.050	1.950 - 2.400	16	2.400	5	<b>234000</b>
				10	1.050	1.950 - 2.400	16	2.400	5	<b>233990</b>
			40	8	1.050	1.950 - 2.400	16	2.400	5	<b>234001</b>
				10	1.050	1.950 - 2.400	16	2.400	5	<b>233991</b>
			45	8	1.050	1.950 - 2.400	16	2.400	5	<b>234002</b>
				10	1.050	1.950 - 2.400	16	2.400	5	<b>233992</b>
			50	8	1.050	1.950 - 2.400	16	2.400	5	<b>234003</b>
				10	1.050	1.950 - 2.400	16	2.400	5	<b>233993</b>
			55	8	1.050	1.950 - 2.400	16	2.400	5	<b>234004</b>
				10	1.050	1.950 - 2.400	16	2.400	5	<b>233994</b>
			65	8	1.050	1.950 - 2.400	16	2.400	5	<b>234005</b>
				10	1.050	1.950 - 2.400	16	2.400	5	<b>233995</b>
			70	8	1.050	1.950 - 2.400	16	2.400	5	<b>234006</b>
				10	1.050	1.950 - 2.400	16	2.400	5	<b>233996</b>
			80	8	1.050	1.950 - 2.400	16	2.400	5	<b>234007</b>
				10	1.050	1.950 - 2.400	16	2.400	5	<b>233997</b>

### Flat faceplate 20 mm

235124









4.5.2.2 Door lock Z-TS Module PT-M with 4 HO-BO E92 F-20								L		No
modular	silver	92	35	8	1.050	1.950 - 2.400	20	2.400	5	<b>235120</b>
				10	1.050	1.950 - 2.400	20	2.400	5	<b>235110</b>
			40	8	1.050	1.950 - 2.400	20	2.400	5	<b>235121</b>
				10	1.050	1.950 - 2.400	20	2.400	5	<b>235111</b>
			45	8	1.050	1.950 - 2.400	20	2.400	5	<b>235122</b>
				10	1.050	1.950 - 2.400	20	2.400	5	<b>235112</b>
			50	8	1.050	1.950 - 2.400	20	2.400	5	<b>235123</b>
				10	1.050	1.950 - 2.400	20	2.400	5	<b>235113</b>
			55	8	1.050	1.950 - 2.400	20	2.400	5	<b>235124</b>
				10	1.050	1.950 - 2.400	20	2.400	5	<b>235114</b>
			65	8	1.050	1.950 - 2.400	20	2.400	5	<b>235125</b>
				10	1.050	1.950 - 2.400	20	2.400	5	<b>235115</b>
			70	8	1.050	1.950 - 2.400	20	2.400	5	<b>235126</b>
				10	1.050	1.950 - 2.400	20	2.400	5	<b>235116</b>
			80	8	1.050	1.950 - 2.400	20	2.400	5	<b>235127</b>
				10	1.050	1.950 - 2.400	20	2.400	5	<b>235117</b>

## Flat faceplate 24 mm

234814









4.5.2.3 Door lock Z-TS Module PT-M with 4 HO-BO E92 F-24								L		No
modular	silver	92	35	8	1.050	1.950 - 2.400	24	2.400	5	<b>234810</b>
				10	1.050	1.950 - 2.400	24	2.400	5	<b>234800</b>
		40	8	1.050	1.950 - 2.400	24	2.400	5	<b>234811</b>	
			10	1.050	1.950 - 2.400	24	2.400	5	<b>234801</b>	
		45	8	1.050	1.950 - 2.400	24	2.400	5	<b>234812</b>	
			10	1.050	1.950 - 2.400	24	2.400	5	<b>234802</b>	
		50	8	1.050	1.950 - 2.400	24	2.400	5	<b>234813</b>	
			10	1.050	1.950 - 2.400	24	2.400	5	<b>234803</b>	
		55	8	1.050	1.950 - 2.400	24	2.400	5	<b>234814</b>	
			10	1.050	1.950 - 2.400	24	2.400	5	<b>234804</b>	
		65	8	1.050	1.950 - 2.400	24	2.400	5	<b>234815</b>	
			10	1.050	1.950 - 2.400	24	2.400	5	<b>234805</b>	
		70	8	1.050	1.950 - 2.400	24	2.400	5	<b>234816</b>	
			10	1.050	1.950 - 2.400	24	2.400	5	<b>234806</b>	
		80	8	1.050	1.950 - 2.400	24	2.400	5	<b>234817</b>	
			10	1.050	1.950 - 2.400	24	2.400	5	<b>234807</b>	

4

## Top hat faceplate 24/16 mm

239514



4.5.2.4 Door lock Z-TS Module PT-M with 4 HO-BO E92 F-24/16								L		No
silver		92	35	8	1.050	1.950 - 2.400	24/16	2.400	5	<b>239510</b>
				10	1.050	1.950 - 2.400	24/16	2.400	5	<b>239520</b>
		40	8	1.050	1.950 - 2.400	24/16	2.400	5	<b>239511</b>	
			10	1.050	1.950 - 2.400	24/16	2.400	5	<b>239521</b>	
		45	8	1.050	1.950 - 2.400	24/16	2.400	5	<b>239512</b>	
			10	1.050	1.950 - 2.400	24/16	2.400	5	<b>239522</b>	
		50	8	1.050	1.950 - 2.400	24/16	2.400	5	<b>239513</b>	
			10	1.050	1.950 - 2.400	24/16	2.400	5	<b>239523</b>	
		55	8	1.050	1.950 - 2.400	24/16	2.400	5	<b>239514</b>	
			10	1.050	1.950 - 2.400	24/16	2.400	5	<b>239524</b>	
		65	8	1.050	1.950 - 2.400	24/16	2.400	5	<b>239515</b>	
			10	1.050	1.950 - 2.400	24/16	2.400	5	<b>239525</b>	
		70	8	1.050	1.950 - 2.400	24/16	2.400	5	<b>239516</b>	
			10	1.050	1.950 - 2.400	24/16	2.400	5	<b>239526</b>	
		80	8	1.050	1.950 - 2.400	24/16	2.400	5	<b>239517</b>	
			10	1.050	1.950 - 2.400	24/16	2.400	5	<b>239527</b>	

## U-faceplate 6x24x6 mm

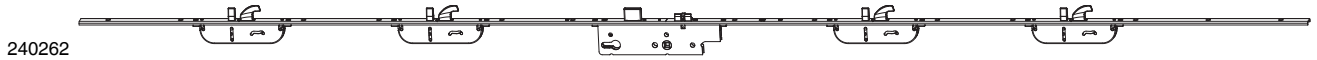

240262

### 4.5.2.5 Door lock Z-TS Module PT-M with 4 HO-BO E92 U-6x24x6 HH 1050

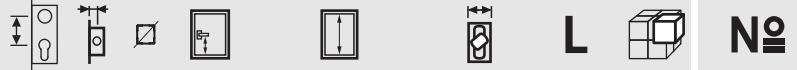

fixed handle height	silver	92	35	8	1.050	1.950 - 2.400	24	2.200	5	No
				10	1.050	1.950 - 2.200	24	2.200	5	240260
			40	8	1.050	1.950 - 2.400	24	2.200	5	240261
				10	1.050	1.950 - 2.200	24	2.200	5	240271
			45	8	1.050	1.950 - 2.400	24	2.200	5	240262
				10	1.050	1.950 - 2.200	24	2.200	5	240272

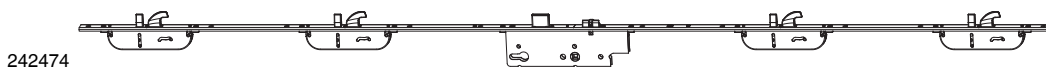

242474

### 4.5.2.6 Door lock Z-TS Module PT-M with 4 HO-BO E85 U-6x24x6 HH885

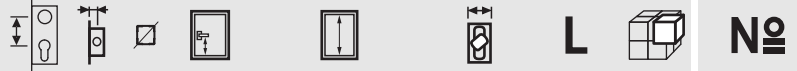

fixed handle height	silver	92	35	8	885	1.950 - 2.400	24	1.740	5	No
				10	885	1.950 - 2.400	24	1.740	5	242470
			40	8	885	1.950 - 2.400	24	1.740	5	242471
				10	885	1.950 - 2.400	24	1.740	5	242481
			45	8	885	1.950 - 2.400	24	1.740	5	242472
				10	885	1.950 - 2.400	24	1.740	5	242482
			50	8	885	1.950 - 2.400	24	1.740	5	242473
				10	885	1.950 - 2.400	24	1.740	5	242483
			55	8	885	1.950 - 2.400	24	1.740	5	242474
				10	885	1.950 - 2.400	24	1.740	5	242484

## Flat faceplate 16 mm

236054



### 4.5.2.7 Door lock Z-TS Module PT-M with 4 HO-BO E94 F-16

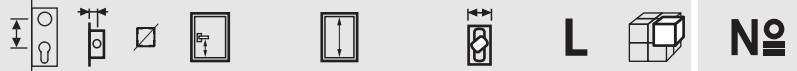

modular	silver	94	35	9	1.050	1.950 - 2.400	16	2.400	5	No
			40	9	1.050	1.950 - 2.400	16	2.400	5	236050
			45	9	1.050	1.950 - 2.400	16	2.400	5	236051
			50	9	1.050	1.950 - 2.400	16	2.400	5	236052
			55	9	1.050	1.950 - 2.400	16	2.400	5	236053
			65	9	1.050	1.950 - 2.400	16	2.400	5	236054
			70	9	1.050	1.900 - 2.400	16	2.400	5	236055
			80	9	1.050	1.900 - 2.400	16	2.400	5	236056
										236057

## Flat faceplate 20 mm

236074



### 4.5.2.8 Door lock Z-TS Module PT-M with 4 HO-BO E94 F-20



		94	35	9	1.050	1.950 - 2.400	20	L	5	No
modular	silver		40	9	1.050	1.950 - 2.400	20	2.400	5	<b>236070</b>
			45	9	1.050	1.950 - 2.400	20	2.400	5	<b>236071</b>
			50	9	1.050	1.950 - 2.400	20	2.400	5	<b>236072</b>
			55	9	1.050	1.900 - 2.400	20	2.400	5	<b>236073</b>
			65	9	1.050	1.900 - 2.400	20	2.400	5	<b>236074</b>
			70	9	1.050	1.900 - 2.400	20	2.400	5	<b>236075</b>
			80	9	1.050	1.900 - 2.400	20	2.400	5	<b>236076</b>

4

## 4.6 Door lock Z-TS Module with HO-BO + ZS









### 4.6.1 Door lock Z-TS with 2 HO-BO + ZS

Flat faceplate 16 mm

234044



#### 4.6.1.1 Door lock Z-TS Module PT-M with 2 HO-BO + ZS E92 F-16









										
modular	silver	92	35	8	1.050	1.950 - 2.400	16	2.400	5	<b>234040</b>
				10	1.050	1.950 - 2.400	16	2.400	5	<b>234030</b>
			40	8	1.050	1.950 - 2.400	16	2.400	5	<b>234041</b>
				10	1.050	1.950 - 2.400	16	2.400	5	<b>234031</b>
			45	8	1.050	1.950 - 2.400	16	2.400	5	<b>234042</b>
				10	1.050	1.950 - 2.400	16	2.400	5	<b>234032</b>
			50	8	1.050	1.950 - 2.400	16	2.400	5	<b>234043</b>
				10	1.050	1.950 - 2.400	16	2.400	5	<b>234033</b>
			55	8	1.050	1.950 - 2.400	16	2.400	5	<b>234044</b>
				10	1.050	1.950 - 2.400	16	2.400	5	<b>234034</b>
			65	8	1.050	1.950 - 2.400	16	2.400	5	<b>234045</b>
				10	1.050	1.950 - 2.400	16	2.400	5	<b>234035</b>
			70	8	1.050	1.950 - 2.400	16	2.400	5	<b>234046</b>
				10	1.050	1.950 - 2.400	16	2.400	5	<b>234036</b>
			80	8	1.050	1.950 - 2.400	16	2.400	5	<b>234047</b>
				10	1.050	1.950 - 2.400	16	2.400	5	<b>234037</b>

Flat faceplate 20 mm

235164



#### 4.6.1.2 Door lock Z-TS Module PT-M with 2 HO-BO + ZS E92 F-20

										
modular	silver	92	35	8	1.050	1.950 - 2.400	20	2.400	5	<b>235160</b>
				10	1.050	1.950 - 2.400	20	2.400	5	<b>235150</b>
			40	8	1.050	1.950 - 2.400	20	2.400	5	<b>235161</b>
				10	1.050	1.950 - 2.400	20	2.400	5	<b>235151</b>
			45	8	1.050	1.950 - 2.400	20	2.400	5	<b>235162</b>
				10	1.050	1.950 - 2.400	20	2.400	5	<b>235152</b>
			50	8	1.050	1.950 - 2.400	20	2.400	5	<b>235163</b>
				10	1.050	1.950 - 2.400	20	2.400	5	<b>235153</b>
			55	8	1.050	1.950 - 2.400	20	2.400	5	<b>235164</b>
				10	1.050	1.950 - 2.400	20	2.400	5	<b>235154</b>
			65	8	1.050	1.950 - 2.400	20	2.400	5	<b>235165</b>
				10	1.050	1.950 - 2.400	20	2.400	5	<b>235155</b>
			70	8	1.050	1.950 - 2.400	20	2.400	5	<b>235166</b>
				10	1.050	1.950 - 2.400	20	2.400	5	<b>235156</b>
			80	8	1.050	1.950 - 2.400	20	2.400	5	<b>235167</b>
				10	1.050	1.950 - 2.400	20	2.400	5	<b>235157</b>

## 4.7 Door lock Z-TS Module with HO + i.S.

### 4.7.1 Door lock Z-TS with 2 HO and 2i.S.

#### Flat faceplate 16 mm

238664



#### 4.7.1.1 Door lock Z-TS Module PT-M with 2 HO + 2i.S. E92 F-16



modular	silver	92	35	8	1.050	1.950 - 2.400	16	2.400	5	<b>No</b>
				10	1.050	1.950 - 2.400	16	2.400	5	<b>238660</b>
			40	8	1.050	1.950 - 2.400	16	2.400	5	<b>238661</b>
				10	1.050	1.950 - 2.400	16	2.400	5	<b>238671</b>
			45	8	1.050	1.950 - 2.400	16	2.400	5	<b>238662</b>
				10	1.050	1.950 - 2.400	16	2.400	5	<b>238672</b>
			50	8	1.050	1.950 - 2.400	16	2.400	5	<b>238663</b>
				10	1.050	1.950 - 2.400	16	2.400	5	<b>238673</b>
			55	8	1.050	1.950 - 2.400	16	2.400	5	<b>238664</b>
				10	1.050	1.950 - 2.400	16	2.400	5	<b>238674</b>
			65	8	1.050	1.950 - 2.400	16	2.400	5	<b>238665</b>
				10	1.050	1.950 - 2.400	16	2.400	5	<b>238675</b>
			70	8	1.050	1.950 - 2.400	16	2.400	5	<b>238666</b>
				10	1.050	1.950 - 2.400	16	2.400	5	<b>238676</b>
			80	8	1.050	1.950 - 2.400	16	2.400	5	<b>238667</b>
				10	1.050	1.950 - 2.400	16	2.400	5	<b>238677</b>

#### Flat faceplate 20 mm

238814



#### 4.7.1.2 Door lock Z-TS Module PT-M with 2 HO + 2i.S. E92 F-16



modular	silver	92	35	8	1.050	1.950 - 2.400	20	2.400	5	<b>No</b>
				10	1.050	1.950 - 2.400	20	2.400	5	<b>238810</b>
			40	8	1.050	1.950 - 2.400	20	2.400	5	<b>238811</b>
				10	1.050	1.950 - 2.400	20	2.400	5	<b>238821</b>
			45	8	1.050	1.950 - 2.400	20	2.400	5	<b>238812</b>
				10	1.050	1.950 - 2.400	20	2.400	5	<b>238822</b>
			50	8	1.050	1.950 - 2.400	20	2.400	5	<b>238813</b>
				10	1.050	1.950 - 2.400	20	2.400	5	<b>238823</b>
			55	8	1.050	1.950 - 2.400	20	2.400	5	<b>238814</b>
				10	1.050	1.950 - 2.400	20	2.400	5	<b>238824</b>
			65	8	1.050	1.950 - 2.400	20	2.400	5	<b>238815</b>
				10	1.050	1.950 - 2.400	20	2.400	5	<b>238825</b>
			70	8	1.050	1.950 - 2.400	20	2.400	5	<b>238816</b>
				10	1.050	1.950 - 2.400	20	2.400	5	<b>238826</b>
			80	8	1.050	1.950 - 2.400	20	2.400	5	<b>238817</b>
				10	1.050	1.950 - 2.400	20	2.400	5	<b>238827</b>

## 4.8 Door lock Z-TS Module with HO







### 4.8.1 Door lock Z-TS with 2 HO

Flat faceplate 16 mm

238354









#### 4.8.1.1 Door lock Z-TS Module PT-M with 2 HO E92 F-16

								<b>L</b>		<b>No</b>
modular	silver	92	35	8	1.050	1.950 - 2.400	16	2.400	5	<b>238350</b>
				10	1.050	1.950 - 2.400	16	2.400	5	<b>238360</b>
			40	8	1.050	1.950 - 2.400	16	2.400	5	<b>238351</b>
				10	1.050	1.950 - 2.400	16	2.400	5	<b>238361</b>
			45	8	1.050	1.950 - 2.400	16	2.400	5	<b>238352</b>
				10	1.050	1.950 - 2.400	16	2.400	5	<b>238362</b>
			50	8	1.050	1.950 - 2.400	16	2.400	5	<b>238353</b>
				10	1.050	1.950 - 2.400	16	2.400	5	<b>238363</b>
			55	8	1.050	1.950 - 2.400	16	2.400	5	<b>238354</b>
				10	1.050	1.950 - 2.400	16	2.400	5	<b>238364</b>
			65	8	1.050	1.950 - 2.400	16	2.400	5	<b>238355</b>
				10	1.050	1.950 - 2.400	16	2.400	5	<b>238365</b>
			70	8	1.050	1.950 - 2.400	16	2.400	5	<b>238356</b>
				10	1.050	1.950 - 2.400	16	2.400	5	<b>238366</b>
			80	8	1.050	1.950 - 2.400	16	2.400	5	<b>238357</b>
				10	1.050	1.950 - 2.400	16	2.400	5	<b>238367</b>

234624









#### 4.8.1.2 Door lock Z-TS Module PT-M with 2 HO + ZS E92 F-16

								<b>L</b>		<b>No</b>
modular	silver	92	35	8	1.050	1.950 - 2.400	16	2.400	5	<b>234620</b>
				10	1.050	1.950 - 2.400	16	2.400	5	<b>234290</b>
			40	8	1.050	1.950 - 2.400	16	2.400	5	<b>234621</b>
				10	1.050	1.950 - 2.400	16	2.400	5	<b>234291</b>
			45	8	1.050	1.950 - 2.400	16	2.400	5	<b>234622</b>
				10	1.050	1.950 - 2.400	16	2.400	5	<b>234292</b>
			50	8	1.050	1.950 - 2.400	16	2.400	5	<b>234623</b>
				10	1.050	1.950 - 2.400	16	2.400	5	<b>234293</b>
			55	8	1.050	1.950 - 2.400	16	2.400	5	<b>234624</b>
				10	1.050	1.950 - 2.400	16	2.400	5	<b>234294</b>
			65	8	1.050	1.950 - 2.400	16	2.400	5	<b>234625</b>
				10	1.050	1.950 - 2.400	16	2.400	5	<b>234295</b>
			70	8	1.050	1.950 - 2.400	16	2.400	5	<b>234626</b>
				10	1.050	1.950 - 2.400	16	2.400	5	<b>234296</b>
			80	8	1.050	1.950 - 2.400	16	2.400	5	<b>234627</b>
				10	1.050	1.950 - 2.400	16	2.400	5	<b>234297</b>

## Flat faceplate 20 mm

234324









4.8.1.3 Door lock Z-TS Module PT-M with 2 HO E92 F-20								<b>L</b>		<b>No</b>
modular	silver	92	35	8	1.050	1.950 - 2.400	20	2.400	5	<b>234320</b>
			10	1.050	1.950 - 2.400	20	2.400	5	<b>234330</b>	
		40	8	1.050	1.950 - 2.400	20	2.400	5	<b>234321</b>	
			10	1.050	1.950 - 2.400	20	2.400	5	<b>234331</b>	
		45	8	1.050	1.950 - 2.400	20	2.400	5	<b>234322</b>	
			10	1.050	1.950 - 2.400	20	2.400	5	<b>234332</b>	
		50	8	1.050	1.950 - 2.400	20	2.400	5	<b>234323</b>	
			10	1.050	1.950 - 2.400	20	2.400	5	<b>234333</b>	
		55	8	1.050	1.950 - 2.400	20	2.400	5	<b>234324</b>	
			10	1.050	1.950 - 2.400	20	2.400	5	<b>234334</b>	
		65	8	1.050	1.950 - 2.400	20	2.400	5	<b>234325</b>	
			10	1.050	1.950 - 2.400	20	2.400	5	<b>234335</b>	
		70	8	1.050	1.950 - 2.400	20	2.400	5	<b>234326</b>	
			10	1.050	1.950 - 2.400	20	2.400	5	<b>234336</b>	
		80	8	1.050	1.950 - 2.400	20	2.400	5	<b>234327</b>	
			10	1.050	1.950 - 2.400	20	2.400	5	<b>234337</b>	

4

244612









4.8.1.4 Door lock Varia Z-TS Module PT-M with 2 HO-BO E92 R20 HH1300								<b>L</b>		<b>No</b>
fixed handle height	silver	92	35	8	1.300	1.950 - 2.400	20 / R	1.750	5	<b>244610</b>
			45	8	1.300	1.950 - 2.400	20 / R	1.750	5	<b>244612</b>

## Flat faceplate 24 mm

234384









4.8.1.5 Door lock Z-TS Module PT-M with 2 HO E92 F-24								<b>L</b>		<b>No</b>
modular	silver	92	35	8	1.050	1.950 - 2.400	24	2.400	5	<b>234380</b>
			10	1.050	1.950 - 2.400	24	2.400	5	<b>234390</b>	
		40	8	1.050	1.950 - 2.400	24	2.400	5	<b>234381</b>	
			10	1.050	1.950 - 2.400	24	2.400	5	<b>234391</b>	
		45	8	1.050	1.950 - 2.400	24	2.400	5	<b>234382</b>	
			10	1.050	1.950 - 2.400	24	2.400	5	<b>234392</b>	
		50	8	1.050	1.950 - 2.400	24	2.400	5	<b>234383</b>	
			10	1.050	1.950 - 2.400	24	2.400	5	<b>234393</b>	
		55	8	1.050	1.950 - 2.400	24	2.400	5	<b>234384</b>	
			10	1.050	1.950 - 2.400	24	2.400	5	<b>234394</b>	
		65	8	1.050	1.950 - 2.400	24	2.400	5	<b>234385</b>	
			10	1.050	1.950 - 2.400	24	2.400	5	<b>234395</b>	
		70	8	1.050	1.950 - 2.400	24	2.400	5	<b>234386</b>	
			10	1.050	1.950 - 2.400	24	2.400	5	<b>234396</b>	
		80	8	1.050	1.950 - 2.400	24	2.400	5	<b>234387</b>	
			10	1.050	1.950 - 2.400	24	2.400	5	<b>234397</b>	

## Top hat faceplate 24/16 mm

239494







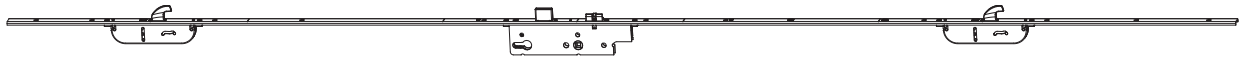

4.8.1.6 Door lock Z-TS Module PT-M with 2 HO E92 F-24/16								<b>L</b>		<b>No</b>
modular	silver	92	35	8	1.050	1.950 - 2.400	24/16	2.400	5	<b>239490</b>
				10	1.050	1.950 - 2.400	24/16	2.400	5	<b>239500</b>
		40	8	1.050	1.950 - 2.400	24/16	2.400	5	<b>239491</b>	
				10	1.050	1.950 - 2.400	24/16	2.400	5	<b>239501</b>
		45	8	1.050	1.950 - 2.400	24/16	2.400	5	<b>239492</b>	
				10	1.050	1.950 - 2.400	24/16	2.400	5	<b>239502</b>
		50	8	1.050	1.950 - 2.400	24/16	2.400	5	<b>239493</b>	
				10	1.050	1.950 - 2.400	24/16	2.400	5	<b>239503</b>
		55	8	1.050	1.950 - 2.400	24/16	2.400	5	<b>239494</b>	
				10	1.050	1.950 - 2.400	24/16	2.400	5	<b>239504</b>
		65	8	1.050	1.950 - 2.400	24/16	2.400	5	<b>239495</b>	
				10	1.050	1.950 - 2.400	24/16	2.400	5	<b>239505</b>
		70	8	1.050	1.950 - 2.400	24/16	2.400	5	<b>239496</b>	
				10	1.050	1.950 - 2.400	24/16	2.400	5	<b>239506</b>
		80	8	1.050	1.950 - 2.400	24/16	2.400	5	<b>239497</b>	
				10	1.050	1.950 - 2.400	24/16	2.400	5	<b>239507</b>

## U-faceplate 6x24x6 mm

239764



4.8.1.7 Door lock Z-TS Module PT-M with 2 HO E92 U-6x24x6								<b>L</b>		<b>No</b>
fixed handle height	silver	92	35	8	1.050	1.950 - 2.200	24	2.200	5	<b>239760</b>
				10	1.050	1.950 - 2.200	24	2.200	5	<b>239750</b>
		40	8	1.050	1.950 - 2.200	24	2.200	5	<b>239761</b>	
				10	1.050	1.950 - 2.200	24	2.200	5	<b>239751</b>
		45	8	1.050	1.950 - 2.200	24	2.200	5	<b>239762</b>	
				10	1.050	1.950 - 2.200	24	2.200	5	<b>239752</b>
		50	8	1.050	1.950 - 2.200	24	2.200	5	<b>239763</b>	
				10	1.050	1.950 - 2.200	24	2.200	5	<b>239753</b>
		55	8	1.050	1.950 - 2.200	24	2.200	5	<b>239764</b>	
				10	1.050	1.950 - 2.200	24	2.200	5	<b>239754</b>
		65	8	1.050	1.950 - 2.200	24	2.200	5	<b>239765</b>	
				10	1.050	1.950 - 2.200	24	2.200	5	<b>239755</b>
		70	8	1.050	1.950 - 2.200	24	2.200	5	<b>239766</b>	
				10	1.050	1.950 - 2.200	24	2.200	5	<b>239756</b>
		80	8	1.050	1.950 - 2.200	24	2.200	5	<b>239767</b>	
				10	1.050	1.950 - 2.200	24	2.200	5	<b>239757</b>

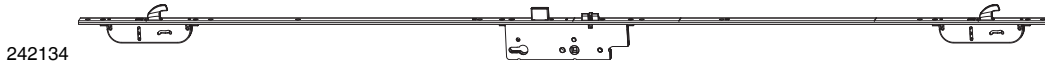

242134

<b>4.8.1.8 Door lock Z-TS Module PT-M with 2 HO E92 U-6x24x6 HH885</b>											<b>No</b>
fixed handle height	silver	92	35	8	885	2.000 - 2.200	24	1.740	5	<b>242130</b>	
				10	885	2.000 - 2.200	24	1.740	5	<b>242140</b>	
		40	8	885	2.000 - 2.200	24	1.740	5	<b>242131</b>		
			10	885	2.000 - 2.200	24	1.740	5	<b>242141</b>		
		45	8	885	2.000 - 2.200	24	1.740	5	<b>242132</b>		
			10	885	2.000 - 2.200	24	1.740	5	<b>242142</b>		
		50	8	885	2.000 - 2.200	24	1.740	5	<b>242133</b>		
			10	885	2.000 - 2.200	24	1.740	5	<b>242143</b>		
		55	8	885	2.000 - 2.200	24	1.740	5	<b>242134</b>		
			10	885	2.000 - 2.200	24	1.740	5	<b>242144</b>		

4



242194

<b>4.8.1.9 Door lock Z-TS Module PT-M with 2 HO E92 U-6x24x6 K+375 HH885</b>											<b>No</b>
fixed handle height	silver	92	35	8	885	1.500 - 1.800	24	1.385	5	<b>242190</b>	
				10	885	1.500 - 1.800	24	1.385	5	<b>242200</b>	
		40	8	885	1.500 - 1.800	24	1.385	5	<b>242191</b>		
			10	885	1.500 - 1.800	24	1.385	5	<b>242201</b>		
		45	8	885	1.500 - 1.800	24	1.385	5	<b>242192</b>		
			10	885	1.500 - 1.800	24	1.385	5	<b>242202</b>		
		50	8	885	1.500 - 1.800	24	1.385	5	<b>242193</b>		
			10	885	1.500 - 1.800	24	1.385	5	<b>242203</b>		
		55	8	885	1.500 - 1.800	24	1.385	5	<b>242194</b>		
			10	885	1.500 - 1.800	24	1.385	5	<b>242204</b>		



242154

<b>4.8.1.10 Door lock Z-TS Module PT-M with 2 HO E92 U-6x24x6 K+605 HH885</b>											<b>No</b>
fixed handle height	silver	92	35	8	885	1.800 - 2.000	24	1.615	5	<b>242150</b>	
				10	885	1.800 - 2.000	24	1.615	5	<b>242160</b>	
		40	8	885	1.800 - 2.000	24	1.615	5	<b>242151</b>		
			10	885	1.800 - 2.000	24	1.615	5	<b>242161</b>		
		45	8	885	1.800 - 2.000	24	1.615	5	<b>242152</b>		
			10	885	1.800 - 2.000	24	1.615	5	<b>242162</b>		
		50	8	885	1.800 - 2.000	24	1.615	5	<b>242153</b>		
			10	885	1.800 - 2.000	24	1.615	5	<b>242163</b>		
		55	8	885	1.800 - 2.000	24	1.615	5	<b>242154</b>		
			10	885	1.800 - 2.000	24	1.615	5	<b>242164</b>		

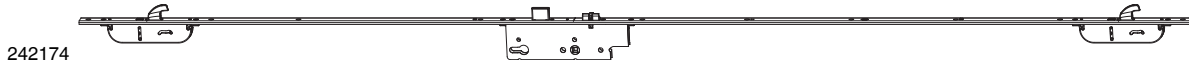

242174

<b>4.8.1.11 Door lock Z-TS Module PT-M with 2 HO E92 U-6x24x6 K+980 HH885</b>								<b>L</b>		<b>No</b>
fixed handle height	silver	92	35	8	885	2.200 - 2.400	24	1.990	5	<b>242170</b>
				10	885	2.200 - 2.400	24	1.990	5	<b>242180</b>
		40	8	885	2.200 - 2.400	24	1.990	5	<b>242171</b>	
										10
		45	8	885	2.200 - 2.400	24	1.990	5	<b>242172</b>	
										10
		50	8	885	2.200 - 2.400	24	1.990	5	<b>242173</b>	
										10
		55	8	885	2.200 - 2.400	24	1.990	5	<b>242174</b>	
										10

### Flat faceplate 16 mm

234274



<b>4.8.1.12 Door lock Z-TS Module PT-M with 2 HO E88 F-16</b>								<b>L</b>		<b>No</b>	
modular	silver	88	35	8,5	1.050	1.950 - 2.400	16	2.400	5	<b>234270</b>	
				40	8,5	1.050	1.950 - 2.400	16	2.400	5	<b>234271</b>
				45	8,5	1.050	1.950 - 2.400	16	2.400	5	<b>234272</b>
				50	8,5	1.050	1.950 - 2.400	16	2.400	5	<b>234273</b>
				55	8,5	1.050	1.950 - 2.400	16	2.400	5	<b>234274</b>
				65	8,5	1.050	1.950 - 2.400	16	2.400	5	<b>234275</b>
				70	8,5	1.050	1.950 - 2.400	16	2.400	5	<b>234276</b>
				80	8,5	1.050	1.950 - 2.400	16	2.400	5	<b>234277</b>

### Flat faceplate 20 mm

234314



<b>4.8.1.13 Door lock Z-TS Module PT-M with 2 HO E88 F-20</b>								<b>L</b>		<b>No</b>	
modular	silver	88	35	8,5	1.050	1.950 - 2.400	20	2.400	5	<b>234310</b>	
				40	8,5	1.050	1.950 - 2.400	20	2.400	5	<b>234311</b>
				45	8,5	1.050	1.950 - 2.400	20	2.200	5	<b>234312</b>
				50	8,5	1.050	1.950 - 2.400	20	2.400	5	<b>234313</b>
				55	8,5	1.050	1.950 - 2.400	20	2.400	5	<b>234314</b>
				65	8,5	1.050	1.950 - 2.400	20	2.400	5	<b>234315</b>
				70	8,5	1.050	1.950 - 2.400	20	2.400	5	<b>234316</b>
				80	8,5	1.050	1.950 - 2.400	20	2.400	5	<b>234317</b>







## 4.9 Door lock Z-TS Module with HO + ZS

### 4.9.1 Door lock Z-TS with 2 HO + ZS

234344



#### 4.9.1.1 Door lock Z-TS Module PT-M with 2 HO + ZS E92 F-20

								L		No
modular	silver	92	35	8	1.050	1.950 - 2.400	20	2.400	5	<b>234340</b>
				10	1.050	1.950 - 2.400	20	2.400	5	<b>234350</b>
			40	8	1.050	1.950 - 2.400	20	2.400	5	<b>234341</b>
				10	1.050	1.950 - 2.400	20	2.400	5	<b>234351</b>
			45	8	1.050	1.950 - 2.400	20	2.400	5	<b>234342</b>
				10	1.050	1.950 - 2.400	20	2.400	5	<b>234352</b>
			50	8	1.050	1.950 - 2.400	20	2.400	5	<b>234343</b>
				10	1.050	1.950 - 2.400	20	2.400	5	<b>234353</b>
			55	8	1.050	1.950 - 2.400	20	2.400	5	<b>234344</b>
				10	1.050	1.950 - 2.400	20	2.400	5	<b>234354</b>
			65	8	1.050	1.950 - 2.400	20	2.400	5	<b>234345</b>
				10	1.050	1.950 - 2.400	20	2.400	5	<b>234355</b>
			70	8	1.050	1.950 - 2.400	20	2.400	5	<b>234346</b>
				10	1.050	1.950 - 2.400	20	2.400	5	<b>234356</b>
			80	8	1.050	1.950 - 2.400	20	2.400	5	<b>234347</b>
				10	1.050	1.950 - 2.400	20	2.400	5	<b>234357</b>

## 4.10 Door lock Z-TS Module with BO + i.S.











### 4.10.1 Door lock Z-TS with 2 BO + 2i.S.

#### Flat faceplate 16 mm

238614



#### 4.10.1.1 Door lock Z-TS Module PT-M with 2 BO + 2i.S. E92 F-16











											
modular	silver	92	35	8	1.050	1.950 - 2.400	16	2.400	5		No
			40	8	1.050	1.950 - 2.400	16	2.400	5		<b>238610</b>
				10	1.050	1.950 - 2.400	16	2.400	5		<b>238611</b>
			45	8	1.050	1.950 - 2.400	16	2.400	5		<b>238621</b>
				10	1.050	1.950 - 2.400	16	2.400	5		<b>238612</b>
			50	8	1.050	1.950 - 2.400	16	2.400	5		<b>238622</b>
				10	1.050	1.950 - 2.400	16	2.400	5		<b>238613</b>
			55	8	1.050	1.950 - 2.400	16	2.400	5		<b>238623</b>
				10	1.050	1.950 - 2.400	16	2.400	5		<b>238614</b>
			65	8	1.050	1.950 - 2.400	16	2.400	5		<b>238624</b>
				10	1.050	1.950 - 2.400	16	2.400	5		<b>238615</b>
			70	8	1.050	1.950 - 2.400	16	2.400	5		<b>238625</b>
				10	1.050	1.950 - 2.400	16	2.400	5		<b>238616</b>
			80	8	1.050	1.950 - 2.400	16	2.400	5		<b>238626</b>
				10	1.050	1.950 - 2.400	16	2.400	5		<b>238617</b>
				10	1.050	1.950 - 2.400	16	2.400	5		<b>238627</b>

#### Flat faceplate 20 mm

238764



#### 4.10.1.2 Door lock Z-TS Module PT-M with 2 BO + 2i.S. E92 F-20

											
modular	silver	92	35	8	1.050	1.950 - 2.400	20	2.400	5		No
			40	8	1.050	1.950 - 2.400	20	2.400	5		<b>238760</b>
				10	1.050	1.950 - 2.400	20	2.400	5		<b>238761</b>
			45	8	1.050	1.950 - 2.400	20	2.400	5		<b>238771</b>
				10	1.050	1.950 - 2.400	20	2.400	5		<b>238762</b>
			50	8	1.050	1.950 - 2.400	20	2.400	5		<b>238772</b>
				10	1.050	1.950 - 2.400	20	2.400	5		<b>238763</b>
			55	8	1.050	1.950 - 2.400	20	2.400	5		<b>238773</b>
				10	1.050	1.950 - 2.400	20	2.400	5		<b>238764</b>
			65	8	1.050	1.950 - 2.400	20	2.400	5		<b>238774</b>
				10	1.050	1.950 - 2.400	20	2.400	5		<b>238765</b>
			70	8	1.050	1.950 - 2.400	20	2.400	5		<b>238775</b>
				10	1.050	1.950 - 2.400	20	2.400	5		<b>238766</b>
			80	8	1.050	1.950 - 2.400	20	2.400	5		<b>238776</b>
				10	1.050	1.950 - 2.400	20	2.400	5		<b>238767</b>
				10	1.050	1.950 - 2.400	20	2.400	5		<b>238777</b>

## 4.11 Door lock Z-TS Module with BO

### 4.11.1 Door lock Z-TS with 2 BO

#### Flat faceplate 16 mm

234604



#### 4.11.1.1 Door lock Z-TS Module PT-M with 2 BO E92 F-16



modular	silver	92	35	8	1.050	1.950 - 2.400	16	2.400	5	No
				10	1.050	1.950 - 2.400	16	2.400	5	<b>234600</b>
			40	8	1.050	1.950 - 2.400	16	2.400	5	<b>234450</b>
				10	1.050	1.950 - 2.400	16	2.400	5	<b>234601</b>
			45	8	1.050	1.950 - 2.400	16	2.400	5	<b>234451</b>
				10	1.050	1.950 - 2.400	16	2.400	5	<b>234602</b>
			50	8	1.050	1.950 - 2.400	16	2.400	5	<b>234452</b>
				10	1.050	1.950 - 2.400	16	2.400	5	<b>234603</b>
			55	8	1.050	1.950 - 2.400	16	2.400	5	<b>234453</b>
				10	1.050	1.950 - 2.400	16	2.400	5	<b>234604</b>
			65	8	1.050	1.950 - 2.400	16	2.400	5	<b>234454</b>
				10	1.050	1.950 - 2.400	16	2.400	5	<b>234605</b>
			70	8	1.050	1.950 - 2.400	16	2.400	5	<b>234455</b>
				10	1.050	1.950 - 2.400	16	2.400	5	<b>234606</b>
			80	8	1.050	1.950 - 2.400	16	2.400	5	<b>234456</b>
				10	1.050	1.950 - 2.400	16	2.400	5	<b>234607</b>
				10	1.050	1.950 - 2.400	16	2.400	5	<b>234457</b>

#### Flat faceplate 20 mm

234504



#### 4.11.1.2 Door lock Z-TS Module PT-M with 2 BO E92 F-20



modular	silver	92	35	8	1.050	1.950 - 2.400	20	2.400	5	No
				10	1.050	1.950 - 2.400	20	2.400	5	<b>234500</b>
			40	8	1.050	1.950 - 2.400	20	2.400	5	<b>234510</b>
				10	1.050	1.950 - 2.400	20	2.400	5	<b>234501</b>
			45	8	1.050	1.950 - 2.400	20	2.400	5	<b>234511</b>
				10	1.050	1.950 - 2.400	20	2.400	5	<b>234502</b>
			50	8	1.050	1.950 - 2.400	20	2.400	5	<b>234512</b>
				10	1.050	1.950 - 2.400	20	2.400	5	<b>234503</b>
			55	8	1.050	1.950 - 2.400	20	2.400	5	<b>234513</b>
				10	1.050	1.950 - 2.400	20	2.400	5	<b>234504</b>
			65	8	1.050	1.950 - 2.400	20	2.400	5	<b>234514</b>
				10	1.050	1.950 - 2.400	20	2.400	5	<b>234505</b>
			70	8	1.050	1.950 - 2.400	20	2.400	5	<b>234515</b>
				10	1.050	1.950 - 2.400	20	2.400	5	<b>234506</b>
			80	8	1.050	1.950 - 2.400	20	2.400	5	<b>234516</b>
				10	1.050	1.950 - 2.400	20	2.400	5	<b>234507</b>
				10	1.050	1.950 - 2.400	20	2.400	5	<b>234517</b>

244622



**4.11.1.3 Door lock Z-TS Module PT-M  
with 2 BO E92 R20 HH1300**



fixed handle height	silver	92	35	8	1.300	1.950 - 2.400	20 / R	1.750	5	No
			45	8	1.300	1.950 - 2.400	20 / R	1.750	5	<b>244620</b>
										<b>244622</b>

**Flat faceplate 24 mm**

234564



**4.11.1.4 Door lock Z-TS Module PT-M  
with 2 BO E92 F-24**



modular	silver	92	35	8	1.050	1.950 - 2.400	24	2.400	5	No
			10	1.050	1.950 - 2.400	24	2.400	5	<b>234560</b>	
			40	8	1.050	1.950 - 2.400	24	2.400	5	<b>234561</b>
			10	1.050	1.950 - 2.400	24	2.400	5	<b>234571</b>	
			45	8	1.050	1.950 - 2.400	24	2.400	5	<b>234562</b>
			10	1.050	1.950 - 2.400	24	2.400	5	<b>234572</b>	
			50	8	1.050	1.950 - 2.400	24	2.400	5	<b>234563</b>
			10	1.050	1.950 - 2.400	24	2.400	5	<b>234573</b>	
			55	8	1.050	1.950 - 2.400	24	2.400	5	<b>234564</b>
			10	1.050	1.950 - 2.400	24	2.400	5	<b>234574</b>	
			65	8	1.050	1.950 - 2.400	24	2.400	5	<b>234565</b>
			10	1.050	1.950 - 2.400	24	2.400	5	<b>234575</b>	
			70	8	1.050	1.950 - 2.400	24	2.400	5	<b>234566</b>
			10	1.050	1.950 - 2.400	24	2.400	5	<b>234576</b>	
			80	8	1.050	1.950 - 2.400	24	2.400	5	<b>234567</b>
			10	1.050	1.950 - 2.400	24	2.400	5	<b>234577</b>	

**Top hat faceplate 24/16 mm**

239474



**4.11.1.5 Door lock Z-TS Module PT-M  
with 2 BO E92 F-24/16**



modular	silver	92	35	8	1.050	1.950 - 2.400	24/16	2.400	5	No
			10	1.050	1.950 - 2.400	24/16	2.400	5	<b>239470</b>	
			40	8	1.050	1.950 - 2.400	24/16	2.400	5	<b>239471</b>
			10	1.050	1.950 - 2.400	24/16	2.400	5	<b>239481</b>	
			45	8	1.050	1.950 - 2.400	24/16	2.400	5	<b>239472</b>
			10	1.050	1.950 - 2.400	24/16	2.400	5	<b>239482</b>	
			50	8	1.050	1.950 - 2.400	24/16	2.400	5	<b>239473</b>
			10	1.050	1.950 - 2.400	24/16	2.400	5	<b>239483</b>	
			55	8	1.050	1.950 - 2.400	24/16	2.400	5	<b>239474</b>
			10	1.050	1.950 - 2.400	24/16	2.400	5	<b>239484</b>	
			65	8	1.050	1.950 - 2.400	24/16	2.400	5	<b>239475</b>
			10	1.050	1.950 - 2.400	24/16	2.400	5	<b>239485</b>	
			70	8	1.050	1.950 - 2.400	24/16	2.400	5	<b>239476</b>
			10	1.050	1.950 - 2.400	24/16	2.400	5	<b>239486</b>	
			80	8	1.050	1.950 - 2.400	24/16	2.400	5	<b>239477</b>
			10	1.050	1.950 - 2.400	24/16	2.400	5	<b>239487</b>	

## U-faceplate 6x24x6 mm

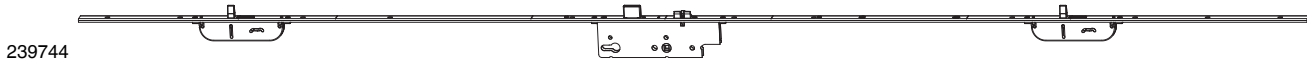

239744

<b>4.11.1.6 Door lock Z-TS Module PT-M with 2 BO E92 U-6x24x6</b>							<b>L</b>		<b>No</b>	
modular	silver	92	35	8	1.050	1.950 - 2.200	24	2.200	5	<b>239740</b>
				10	1.050	1.950 - 2.200	24	2.200	5	<b>239730</b>
			40	8	1.050	1.950 - 2.200	24	2.200	5	<b>239741</b>
				10	1.050	1.950 - 2.200	24	2.200	5	<b>239731</b>
			45	8	1.050	1.950 - 2.200	24	2.200	5	<b>239742</b>
				10	1.050	1.950 - 2.200	24	2.200	5	<b>239732</b>
			50	8	1.050	1.950 - 2.200	24	2.200	5	<b>239743</b>
				10	1.050	1.950 - 2.200	24	2.200	5	<b>239733</b>
			55	8	1.050	1.950 - 2.200	24	2.200	5	<b>239744</b>
				10	1.050	1.950 - 2.200	24	2.200	5	<b>239734</b>
			65	8	1.050	1.950 - 2.200	24	2.200	5	<b>239745</b>
				10	1.050	1.950 - 2.200	24	2.200	5	<b>239735</b>
			70	8	1.050	1.950 - 2.200	24	2.200	5	<b>239746</b>
				10	1.050	1.950 - 2.200	24	2.200	5	<b>239736</b>
			80	8	1.050	1.950 - 2.200	24	2.200	5	<b>239747</b>
				10	1.050	1.950 - 2.200	24	2.200	5	<b>239737</b>

4



242214

<b>4.11.1.7 Door lock Z-TS Module PT-M with 2 BO E92 U-6x24x6 HH885</b>							<b>L</b>		<b>No</b>	
modular	silver	92	35	8	885	2.000 - 2.200	24	1.740	5	<b>242210</b>
				10	885	2.000 - 2.200	24	1.740	5	<b>242220</b>
			40	8	885	2.000 - 2.200	24	1.740	5	<b>242211</b>
				10	885	2.000 - 2.200	24	1.740	5	<b>242221</b>
			45	8	885	2.000 - 2.200	24	1.740	5	<b>242212</b>
				10	885	2.000 - 2.200	24	1.740	5	<b>242222</b>
			50	8	885	2.000 - 2.200	24	1.740	5	<b>242213</b>
				10	885	2.000 - 2.200	24	1.740	5	<b>242223</b>
			55	8	885	2.000 - 2.200	24	1.740	5	<b>242214</b>
				10	885	2.000 - 2.200	24	1.740	5	<b>242224</b>



242314

<b>4.11.1.8 Door lock Z-TS Module PT-M with 2 BO E92 U-6x24x6 HH885 and door turn-restrictor</b>							<b>L</b>		<b>No</b>	
fixed handle height	silver	92	35	8	885	2.000 - 2.200	24	1.740	5	<b>242310</b>
				10	885	2.000 - 2.200	24	1.740	5	<b>242320</b>
			40	8	885	2.000 - 2.200	24	1.740	5	<b>242311</b>
				10	885	2.000 - 2.200	24	1.740	5	<b>242321</b>
			45	8	885	2.000 - 2.200	24	1.740	5	<b>242312</b>
				10	885	2.000 - 2.200	24	1.740	5	<b>242322</b>
			50	8	885	2.000 - 2.200	24	1.740	5	<b>242313</b>
				10	885	2.000 - 2.200	24	1.740	5	<b>242323</b>
			55	8	885	2.000 - 2.200	24	1.740	5	<b>242314</b>
				10	885	2.000 - 2.200	24	1.740	5	<b>242324</b>

242274



**4.11.1.9 Door lock Z-TS Module PT-M  
with 2 BO E92 U-6x24x6 K+375 HH885**



fixed handle height	silver	92	35	8	885	1.500 - 1.800	24	1.385	5	No
				10	885	1.500 - 1.800	24	1.385	5	<b>242270</b>
			40	8	885	1.500 - 1.800	24	1.385	5	<b>242271</b>
				10	885	1.500 - 1.800	24	1.385	5	<b>242281</b>
			45	8	885	1.500 - 1.800	24	1.385	5	<b>242272</b>
				10	885	1.500 - 1.800	24	1.385	5	<b>242282</b>
			50	8	885	1.500 - 1.800	24	1.385	5	<b>242273</b>
				10	885	1.500 - 1.800	24	1.385	5	<b>242283</b>
			55	8	885	1.500 - 1.800	24	1.385	5	<b>242274</b>
				10	885	1.500 - 1.800	24	1.385	5	<b>242284</b>

242234

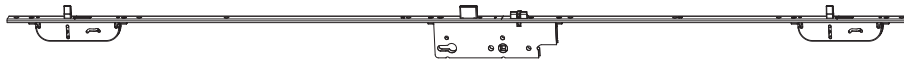

**4.11.1.10 Door lock Z-TS Module PT-M  
with 2 BO E92 U-6x24x6 K+605 HH885**



fixed handle height	silver	92	35	8	885	1.800 - 2.000	24	1.615	5	No
				10	885	1.800 - 2.000	24	1.615	5	<b>242230</b>
			40	8	885	1.800 - 2.000	24	1.615	5	<b>242231</b>
				10	885	1.800 - 2.000	24	1.615	5	<b>242241</b>
			45	8	885	1.800 - 2.000	24	1.615	5	<b>242232</b>
				10	885	1.800 - 2.000	24	1.615	5	<b>242242</b>
			50	8	885	1.800 - 2.000	24	1.615	5	<b>242233</b>
				10	885	1.800 - 2.000	24	1.615	5	<b>242243</b>
			55	8	885	1.800 - 2.000	24	1.615	5	<b>242234</b>
				10	885	1.800 - 2.000	24	1.615	5	<b>242244</b>

242254



**4.11.1.11 Door lock Z-TS Module PT-M  
with 2 BO E92 U-6x24x6 K+980 HH885**



fixed handle height	silver	92	35	8	885	2.200 - 2.400	24	1.990	5	No
				10	885	2.200 - 2.400	24	1.990	5	<b>242250</b>
			40	8	885	2.200 - 2.400	24	1.990	5	<b>242251</b>
				10	885	2.200 - 2.400	24	1.990	5	<b>242261</b>
			45	8	885	2.200 - 2.400	24	1.990	5	<b>242252</b>
				10	885	2.200 - 2.400	24	1.990	5	<b>242262</b>
			50	8	885	2.200 - 2.400	24	1.990	5	<b>242253</b>
				10	885	2.200 - 2.400	24	1.990	5	<b>242263</b>
			55	8	885	2.200 - 2.400	24	1.990	5	<b>242254</b>
				10	885	2.200 - 2.400	24	1.990	5	<b>242264</b>

## Flat faceplate 16 mm

234434



### 4.11.1.12 Door lock Z-TS Module PT-M with 2 BO E88 F-16



modular	silver	88						L		No
		35	8,5	1.050	1.950 - 2.400	16	2.400	5		<b>234430</b>
		40	8,5	1.050	1.950 - 2.400	16	2.400	5		<b>234431</b>
		45	8,5	1.050	1.950 - 2.400	16	2.400	5		<b>234432</b>
		50	8,5	1.050	1.950 - 2.400	16	2.400	5		<b>234433</b>
		55	8,5	1.050	1.950 - 2.400	16	2.400	5		<b>234434</b>
		65	8,5	1.050	1.950 - 2.400	16	2.400	5		<b>234435</b>
		70	8,5	1.050	1.950 - 2.400	16	2.400	5		<b>234436</b>
		80	8,5	1.050	1.950 - 2.400	16	2.400	5		<b>234437</b>

## Flat faceplate 20 mm

234494



### 4.11.1.13 Door lock Z-TS Module PT-M with 2 BO E88 F-20



modular	silver	88						L		No
		35	8,5	1.050	1.950 - 2.400	20	2.400	5		<b>234490</b>
		40	8,5	1.050	1.950 - 2.400	20	2.400	5		<b>234491</b>
		45	8,5	1.050	1.950 - 2.400	20	2.400	5		<b>234492</b>
		50	8,5	1.050	1.950 - 2.400	20	2.400	5		<b>234493</b>
		55	8,5	1.050	1.950 - 2.400	20	2.400	5		<b>234494</b>
		65	8,5	1.050	1.950 - 2.400	20	2.400	5		<b>234495</b>
		70	8,5	1.050	1.950 - 2.400	20	2.400	5		<b>234496</b>
		80	8,5	1.050	1.950 - 2.400	20	2.400	5		<b>234497</b>

## Flat faceplate 16 mm

238504



### 4.11.1.14 Door lock Z-TS Module PT-M with 2 BO E94 F-16









modular	silver	94						L		No
		35	9	1.050	1.950 - 2.400	16	2.400	5		<b>238500</b>
		40	9	1.050	1.950 - 2.400	16	2.400	5		<b>238501</b>
		45	9	1.050	1.950 - 2.400	16	2.400	5		<b>238502</b>
		50	9	1.050	1.950 - 2.400	16	2.400	5		<b>238503</b>
		55	9	1.050	1.950 - 2.400	16	2.400	5		<b>238504</b>
		65	9	1.050	1.950 - 2.400	16	2.400	5		<b>238505</b>
		70	9	1.050	1.950 - 2.400	16	2.400	5		<b>238506</b>
		80	9	1.050	1.950 - 2.400	16	2.400	5		<b>238507</b>

## Flat faceplate 20 mm

238524









4.11.1.15 Door lock Z-TS Module PT-M with 2 BO E94 F-20							L		No	
modular	silver	94	35	9	1.050	1.950 - 2.400	20	2.400	5	<b>238520</b>
			40	9	1.050	1.950 - 2.400	20	2.400	5	<b>238521</b>
			45	9	1.050	1.950 - 2.400	20	2.400	5	<b>238522</b>
			50	9	1.050	1.950 - 2.400	20	2.400	5	<b>238523</b>
			55	9	1.050	1.950 - 2.400	20	2.400	5	<b>238524</b>
			65	9	1.050	1.950 - 2.400	20	2.400	5	<b>238525</b>
			70	9	1.050	1.950 - 2.400	20	2.400	5	<b>238526</b>
			80	9	1.050	1.950 - 2.400	20	2.400	5	<b>238527</b>

## Top hat faceplate 24/16 mm

238544







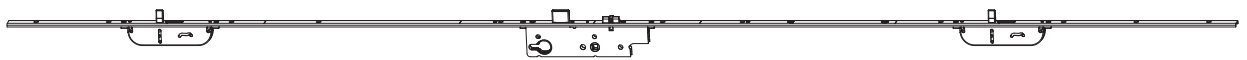

4.11.1.16 Door lock Z-TS Module PT-M with 2 BO E94 F-24/16							L		No	
modular	silver	94	35	9	1.050	1.950 - 2.400	24/16	2.400	5	<b>238540</b>
			40	9	1.050	1.950 - 2.400	24/16	2.400	5	<b>238541</b>
			45	9	1.050	1.950 - 2.400	24/16	2.400	5	<b>238542</b>
			50	9	1.050	1.950 - 2.400	24/16	2.400	5	<b>238543</b>
			55	9	1.050	1.950 - 2.400	24/16	2.400	5	<b>238544</b>
			65	9	1.050	1.950 - 2.400	24/16	2.400	5	<b>238545</b>
			70	9	1.050	1.950 - 2.400	24/16	2.400	5	<b>238546</b>
			80	9	1.050	1.950 - 2.400	24/16	2.400	5	<b>238547</b>

## U-faceplate 6x24x6 mm

238482



4.11.1.17 Door lock Z-TS Module PT-M with 2 BO E94 U-6x24x6							L		No	
modular	silver	94	45	9	1.050	1.950 - 2.200	24	2.200	5	<b>238482</b>

## 4.12 Door lock Z-TS Module with BO + ZS

### 4.12.1 Door lock Z-TS with 2 BO + ZS

#### Flat faceplate 16 mm

234614



#### 4.12.1.1 Door lock Z-TS Module PT-M with 2 BO + ZS E92 F-16



modular	silver	92	35	8	1.050	1.950 - 2.400	16	2.400	5	No
				10	1.050	1.950 - 2.400	16	2.400	5	<b>234610</b>
			40	8	1.050	1.950 - 2.400	16	2.400	5	<b>234470</b>
				10	1.050	1.950 - 2.400	16	2.400	5	<b>234611</b>
			45	8	1.050	1.950 - 2.400	16	2.400	5	<b>234471</b>
				10	1.050	1.950 - 2.400	16	2.400	5	<b>234612</b>
			50	8	1.050	1.950 - 2.400	16	2.400	5	<b>234472</b>
				10	1.050	1.950 - 2.400	16	2.400	5	<b>234613</b>
			55	8	1.050	1.950 - 2.400	16	2.400	5	<b>234473</b>
				10	1.050	1.950 - 2.400	16	2.400	5	<b>234614</b>
			65	8	1.050	1.950 - 2.400	16	2.400	5	<b>234474</b>
				10	1.050	1.950 - 2.400	16	2.400	5	<b>234615</b>
			70	8	1.050	1.950 - 2.400	16	2.400	5	<b>234475</b>
				10	1.050	1.950 - 2.400	16	2.400	5	<b>234616</b>
			80	8	1.050	1.950 - 2.400	16	2.400	5	<b>234476</b>
				10	1.050	1.950 - 2.400	16	2.400	5	<b>234617</b>
				10	1.050	1.950 - 2.400	16	2.400	5	<b>234477</b>

#### Flat faceplate 20 mm

234524



#### 4.12.1.2 Door lock Z-TS Module PT-M with 2 BO + ZS E92 F-20



modular	silver	92	35	8	1.050	1.950 - 2.400	20	2.400	5	No
				10	1.050	1.950 - 2.400	20	2.400	5	<b>234520</b>
			40	8	1.050	1.950 - 2.400	20	2.400	5	<b>234530</b>
				10	1.050	1.950 - 2.400	20	2.400	5	<b>234521</b>
			45	8	1.050	1.950 - 2.400	20	2.400	5	<b>234531</b>
				10	1.050	1.950 - 2.400	20	2.400	5	<b>234522</b>
			50	8	1.050	1.950 - 2.400	20	2.400	5	<b>234532</b>
				10	1.050	1.950 - 2.400	20	2.400	5	<b>234523</b>
			55	8	1.050	1.950 - 2.400	20	2.400	5	<b>234533</b>
				10	1.050	1.950 - 2.400	20	2.400	5	<b>234524</b>
			65	8	1.050	1.950 - 2.400	20	2.400	5	<b>234534</b>
				10	1.050	1.950 - 2.400	20	2.400	5	<b>234525</b>
			70	8	1.050	1.950 - 2.400	20	2.400	5	<b>234535</b>
				10	1.050	1.950 - 2.400	20	2.400	5	<b>234526</b>
			80	8	1.050	1.950 - 2.400	20	2.400	5	<b>234536</b>
				10	1.050	1.950 - 2.400	20	2.400	5	<b>234527</b>
				10	1.050	1.950 - 2.400	20	2.400	5	<b>234537</b>

**MACO  
PROTECT**



## Z-TS Cylinder Operated Door Lock



## 5 G-TS Lever operated Door Lock

---

<b>5.1</b>	<b>Hardware overview G-TS</b>	<b>112</b>
<b>5.2</b>	<b>Door lock G-TS Module with i.S.</b>	<b>118</b>
5.2.1	Door lock G-TS with 4 i.S.	118
5.2.2	Door lock G-TS with 2 i.S.	120
<b>5.3</b>	<b>Door lock G-TS Module with HO-BO + i.S.</b>	<b>121</b>
5.3.1	Door lock G-TS with 2 HO-BO + 2 i.S.	121
<b>5.4</b>	<b>Door lock G-TS Module with HO-BO</b>	<b>122</b>
5.4.1	Door lock G-TS with 2 HO-BO	122
5.4.2	Door lock G-TS with 4 HO-BO	124
<b>5.5</b>	<b>Door lock G-TS Module with HO and i.S.</b>	<b>126</b>
5.5.1	Door lock G-TS with 2 HO and 2 i.S.	126
<b>5.6</b>	<b>Door lock G-TS Module with HO</b>	<b>127</b>
5.6.1	Door lock G-TS with 2 HO	127
<b>5.7</b>	<b>Door lock G-TS Module with BO and i.S.</b>	<b>129</b>
5.7.1	Door lock G-TS with 2 BO and 2 i.S.	129
<b>5.8</b>	<b>Door lock G-TS Module with BO</b>	<b>130</b>
5.8.1	Door lock G-TS with 2 BO	130
<b>5.9</b>	<b>Door lock G-TS Module without i.S.</b>	<b>133</b>
5.9.1	Door lock G-TS without i.S.	133

5 G-TS Lever operated Door Lock

5.1 Hardware overview G-TS

3.1m

MACO PROTECT MODULE

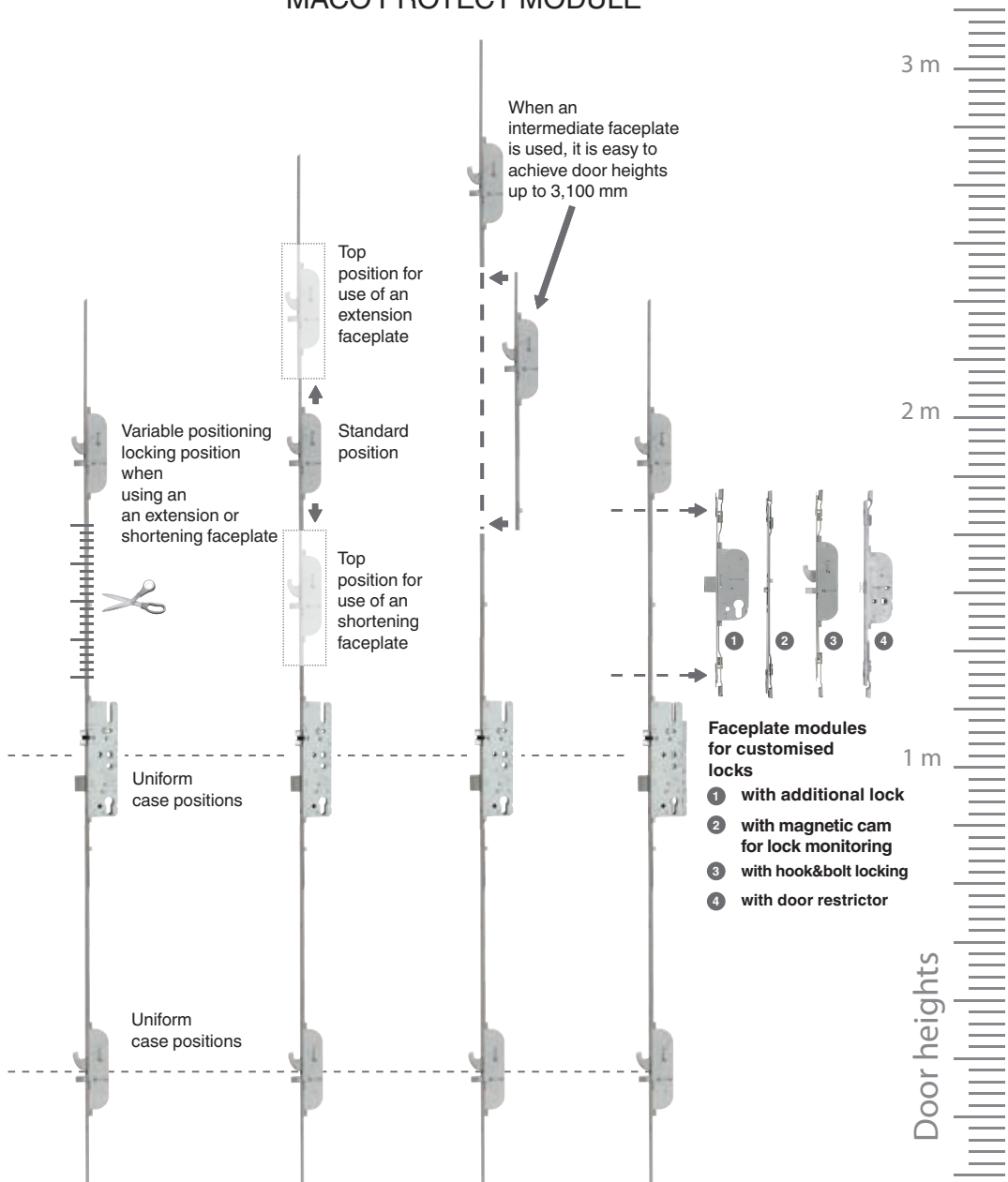

Single box position

- ① 2 x hook&bolt
- ② 4 x hook&bolt
- ③ 2x hook&bolt + additional lock

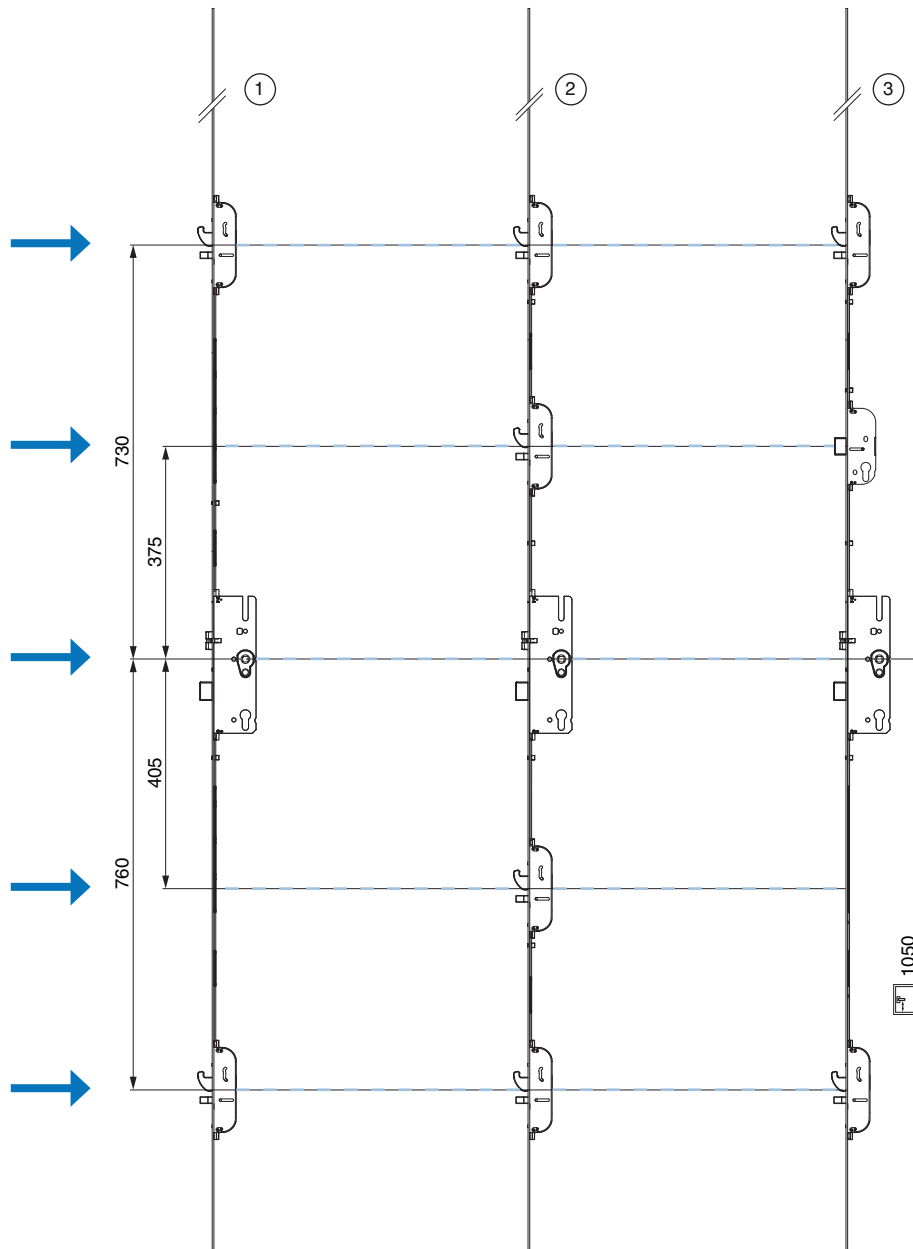

## Variable box position above for hook-bolt

- ① standard lock
- ② shortening faceplate
- ③ extension faceplate

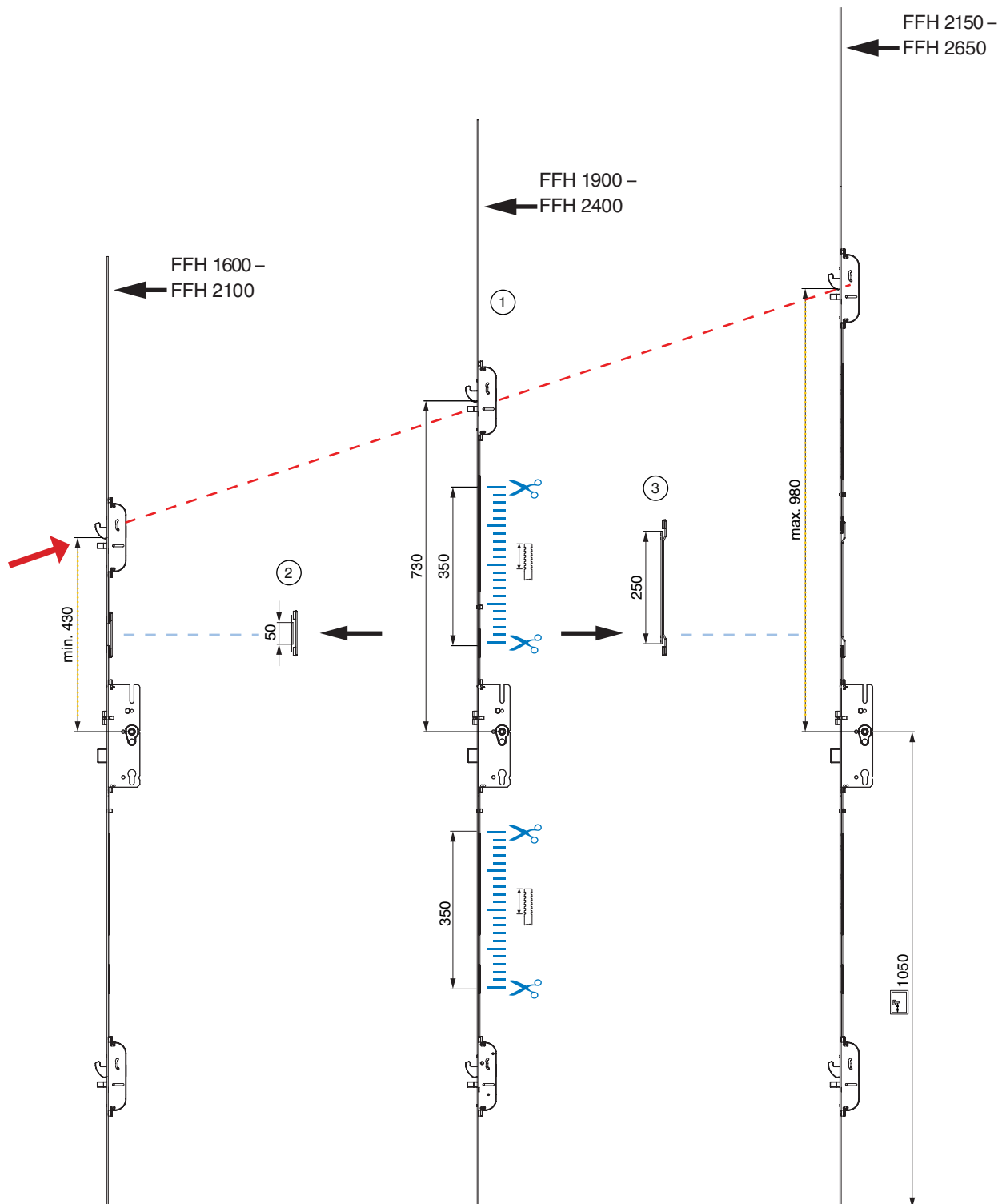

## Variable faceplate module

- ① standard lock
- ② faceplate module ZS
- ③ faceplate module hook&bolt
- ④ faceplate module magnetic cam
- ⑤ faceplate module door restrictor

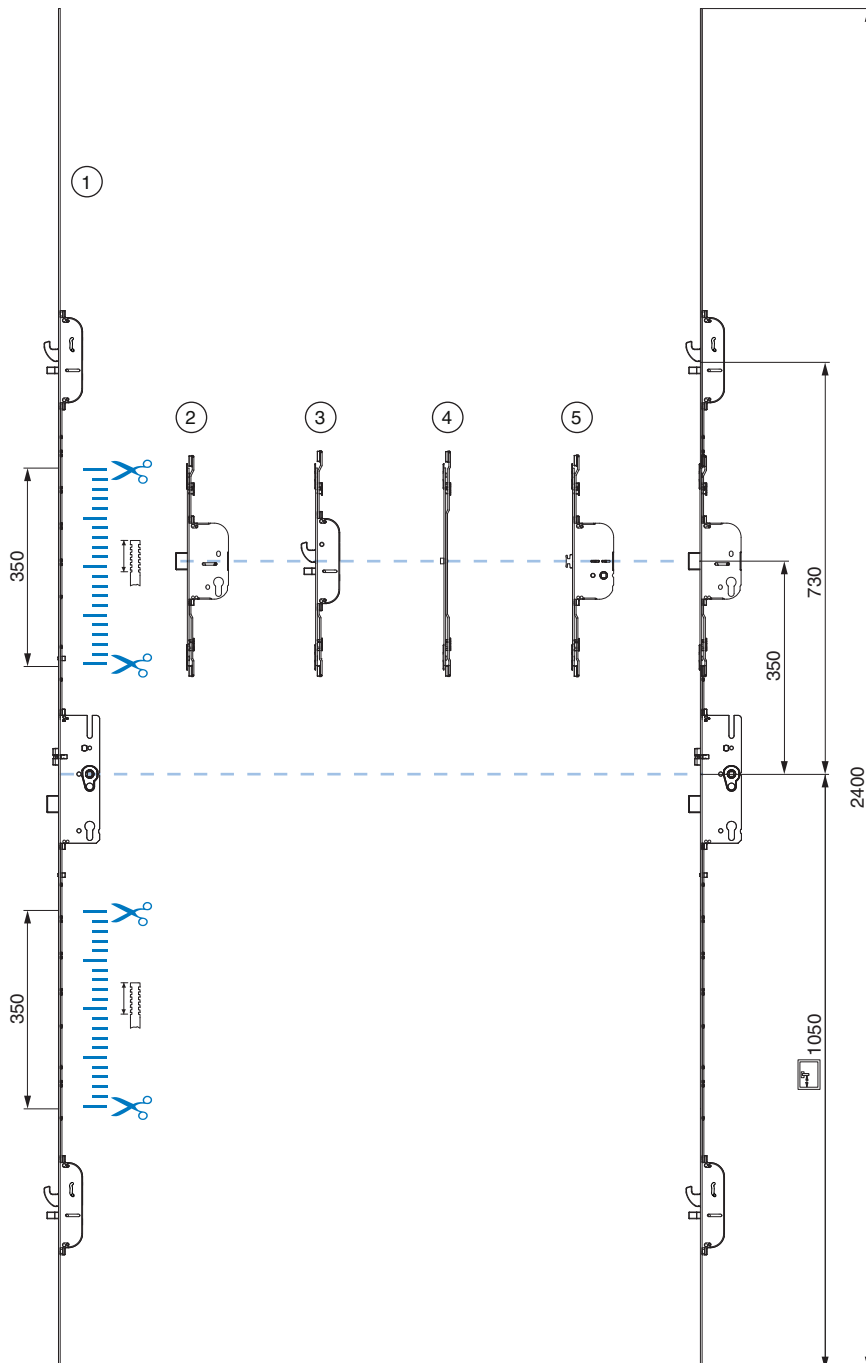



2 hook&bolt

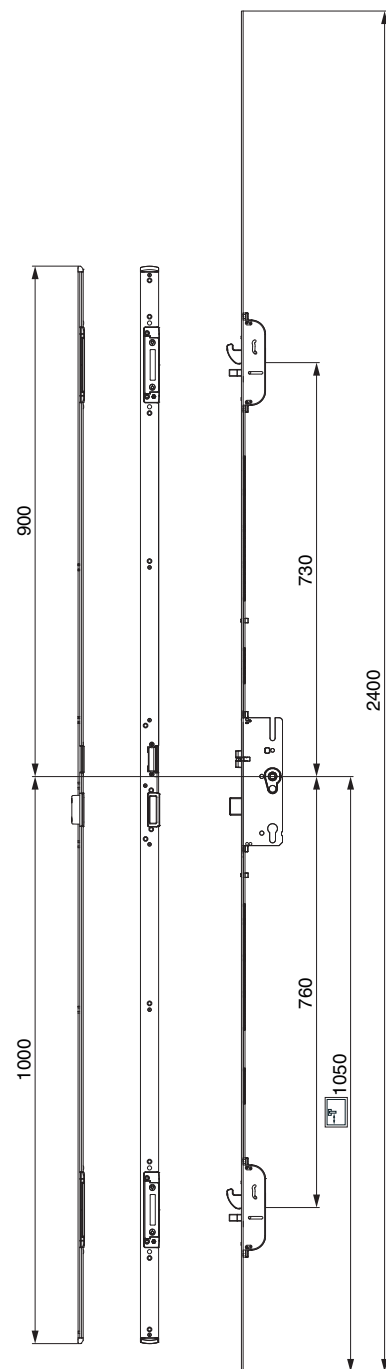
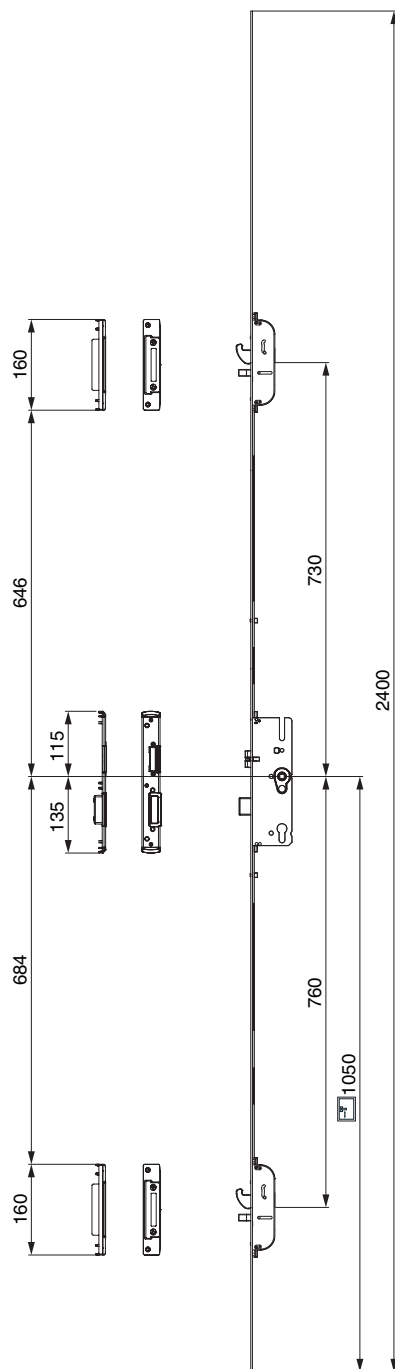



4 i.S.

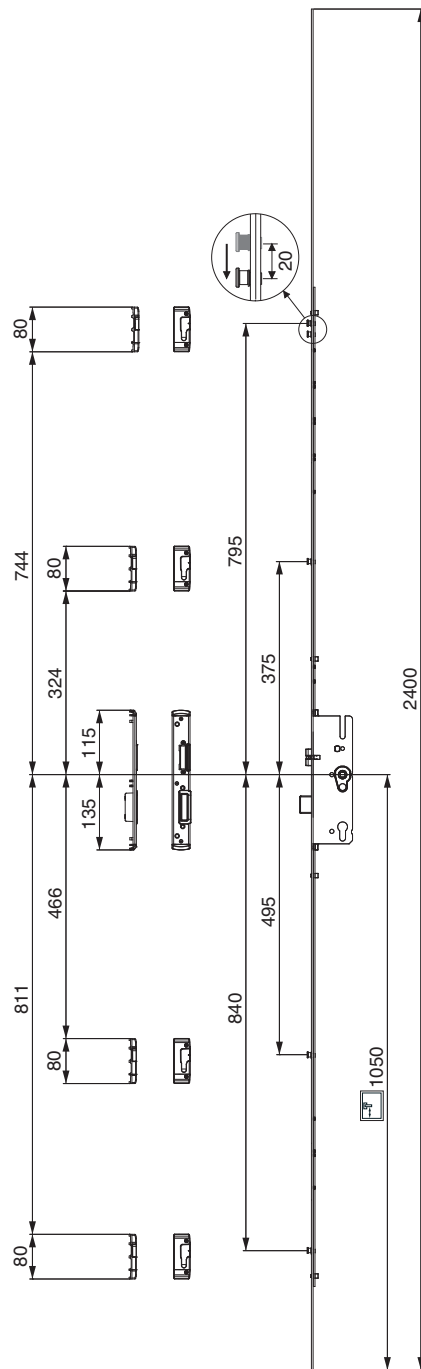

## 5.2 Door lock G-TS Module with i.S.







### 5.2.1 Door lock G-TS with 4 i.S.

#### Flat faceplate 16 mm

232015



#### 5.2.1.1 Door lock G-TS Module PT-M with 4 i.S. E92 F-16







								L		No
extendable	silver	92	28	8	1.050	1.950 - 2.400	16	2.400	5	<b>232010</b>
				10	1.050	1.950 - 2.400	16	2.400	5	<b>232500</b>
				8	1.050	1.950 - 2.400	16	2.400	5	<b>232011</b>
				10	1.050	1.950 - 2.400	16	2.400	5	<b>232501</b>
				8	1.050	1.950 - 2.400	16	2.400	5	<b>232012</b>
				10	1.050	1.950 - 2.400	16	2.400	5	<b>232502</b>
				8	1.050	1.950 - 2.400	16	2.400	5	<b>232013</b>
				10	1.050	1.950 - 2.400	16	2.400	5	<b>232503</b>
				8	1.050	1.950 - 2.400	16	2.400	5	<b>232014</b>
				10	1.050	1.950 - 2.400	16	2.400	5	<b>232504</b>
				8	1.050	1.950 - 2.400	16	2.400	5	<b>232015</b>
				10	1.050	1.950 - 2.400	16	2.400	5	<b>232505</b>
				8	1.050	1.950 - 2.400	16	2.400	5	<b>232016</b>
				10	1.050	1.950 - 2.400	16	2.400	5	<b>232506</b>
				8	1.050	1.950 - 2.400	16	2.400	5	<b>232017</b>
				10	1.050	1.950 - 2.400	16	2.400	5	<b>232507</b>

#### Flat faceplate 20 mm

232215



#### 5.2.1.2 Door lock G-TS Module PT-M with 4 i.S. E92 F-20

								L		No
extendable	silver	92	28	8	1.050	1.950 - 2.400	20	2.400	5	<b>232210</b>
				10	1.050	1.950 - 2.400	20	2.400	5	<b>232570</b>
				8	1.050	1.950 - 2.400	20	2.400	5	<b>232211</b>
				10	1.050	1.950 - 2.400	20	2.400	5	<b>232571</b>
				8	1.050	1.950 - 2.400	20	2.400	5	<b>232212</b>
				10	1.050	1.950 - 2.400	20	2.400	5	<b>232572</b>
				8	1.050	1.950 - 2.400	20	2.400	5	<b>232213</b>
				10	1.050	1.950 - 2.400	20	2.400	5	<b>232573</b>
				8	1.050	1.950 - 2.400	20	2.400	5	<b>232214</b>
				10	1.050	1.950 - 2.400	20	2.400	5	<b>232574</b>
				8	1.050	1.950 - 2.400	20	2.400	5	<b>232215</b>
				10	1.050	1.950 - 2.400	20	2.400	5	<b>232575</b>
				8	1.050	1.950 - 2.400	20	2.400	5	<b>232216</b>
				10	1.050	1.950 - 2.400	20	2.400	5	<b>232576</b>
				8	1.050	1.950 - 2.400	20	2.400	5	<b>232217</b>
				10	1.050	1.950 - 2.400	20	2.400	5	<b>232577</b>

Top hat faceplate 24/16 mm

241945



5.2.1.3 Door lock G-TS Module PT-M  
with 4 i.S. E92 F-24/16



extendable	silver	92	28	8	1.050	1.950 - 2.400	24/16	2.400	5	<b>No</b>
			35	8	1.050	1.950 - 2.400	24/16	2.400	5	<b>241941</b>
			40	8	1.050	1.950 - 2.400	24/16	2.400	5	<b>241942</b>
			45	8	1.050	1.950 - 2.400	24/16	2.400	5	<b>241943</b>
			50	8	1.050	1.950 - 2.400	24/16	2.400	5	<b>241944</b>
			55	8	1.050	1.950 - 2.400	24/16	2.400	5	<b>241945</b>
			60	8	1.050	1.950 - 2.400	24/16	2.400	5	<b>241946</b>
			65	8	1.050	1.950 - 2.400	24/16	2.400	5	<b>241947</b>

Flat faceplate 16 mm

233575



5.2.1.4 Door lock G-TS Module PT-M  
with 4 i.S. E94 F-16



extendable	silver	94	35	9	1.050	1.950 - 2.400	16	2.400	5	<b>No</b>
			40	9	1.050	1.950 - 2.400	16	2.400	5	<b>233572</b>
			45	9	1.050	1.950 - 2.400	16	2.400	5	<b>233573</b>
			50	9	1.050	1.950 - 2.400	16	2.400	5	<b>233574</b>
			55	9	1.050	1.950 - 2.400	16	2.400	5	<b>233575</b>
			60	9	1.050	1.950 - 2.400	16	2.400	5	<b>233576</b>
			65	9	1.050	1.950 - 2.400	16	2.400	5	<b>233577</b>

Flat faceplate 20 mm

233685











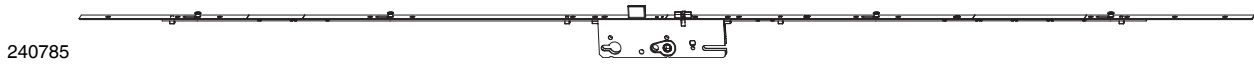

5.2.1.5 Door lock G-TS Module PT-M  
with 4 i.S. E94 F-20



extendable	silver	94	35	9	1.050	1.950 - 2.400	20	2.400	5	<b>No</b>
			40	9	1.050	1.950 - 2.400	20	2.400	5	<b>233682</b>
			45	9	1.050	1.950 - 2.400	20	2.400	5	<b>233683</b>
			50	9	1.050	1.950 - 2.400	20	2.400	5	<b>233684</b>
			55	9	1.050	1.950 - 2.400	20	2.400	5	<b>233685</b>
			60	9	1.050	1.950 - 2.400	20	2.400	5	<b>233686</b>
			65	9	1.050	1.950 - 2.400	20	2.400	5	<b>233687</b>

## Top hat faceplate 24/16 mm









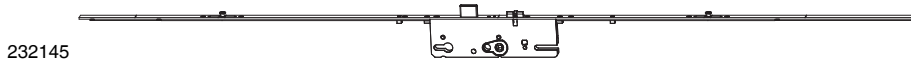

5.2.1.6 Door lock G-TS Module PT-M with 4 i.S. E94 F-24/16										
extendable	silver	94	35	9	1.050	1.950 - 2.400	24/16	2.100	5	<b>240781</b>
			40	9	1.050	1.950 - 2.400	24/16	2.100	5	<b>240782</b>
			45	9	1.050	1.950 - 2.400	24/16	2.100	5	<b>240783</b>
			50	9	1.050	1.950 - 2.400	24/16	2.100	5	<b>240784</b>
			55	9	1.050	1.950 - 2.400	24/16	2.100	5	<b>240785</b>
			60	9	1.050	1.950 - 2.400	24/16	2.100	5	<b>240786</b>
			65	9	1.050	1.950 - 2.400	24/16	2.100	5	<b>240787</b>

## 5.2.2 Door lock G-TS with 2 i.S.

### Flat faceplate 16 mm



5.2.2.1 Door lock G-TS Module PT-M with 2 i.S. E92 F-16										
extendable	silver	92	28	8	1.050	1.900 - 2.500	16	1.500	5	<b>232140</b>
				10	1.050	1.900 - 2.500	16	1.500	5	<b>232170</b>
			35	8	1.050	1.900 - 2.500	16	1.500	5	<b>232141</b>
				10	1.050	1.900 - 2.500	16	1.500	5	<b>232171</b>
			40	8	1.050	1.900 - 2.500	16	1.500	5	<b>232142</b>
				10	1.050	1.900 - 2.500	16	1.500	5	<b>232172</b>
			45	8	1.050	1.900 - 2.500	16	1.500	5	<b>232143</b>
				10	1.050	1.900 - 2.500	16	1.500	5	<b>232173</b>
			50	8	1.050	1.900 - 2.500	16	1.500	5	<b>232144</b>
				10	1.050	1.900 - 2.500	16	1.500	5	<b>232174</b>
			55	8	1.050	1.900 - 2.500	16	1.500	5	<b>232145</b>
				10	1.050	1.900 - 2.500	16	1.500	5	<b>232175</b>
			60	8	1.050	1.900 - 2.500	16	1.500	5	<b>232146</b>
				10	1.050	1.900 - 2.500	16	1.500	5	<b>232176</b>
65	8	1.050	1.900 - 2.500	16	1.500	5	<b>232147</b>			
	10	1.050	1.900 - 2.500	16	1.500	5	<b>232177</b>			

**5.3 Door lock G-TS Module with HO-BO + i.S.**

**5.3.1 Door lock G-TS with 2 HO-BO + 2 i.S.**

**Flat faceplate 16 mm**

234945



**5.3.1.1 Door lock G-TS Module PT-M with 2 HO-BO and 2 i.S. E92 F-16**



extendable	silver	92	28	8	1.050	1.950 - 2.400	16	2.400	5	<b>No</b>
			35	8	1.050	1.950 - 2.400	16	2.400	5	<b>234940</b>
			40	8	1.050	1.950 - 2.400	16	2.400	5	<b>234941</b>
			45	8	1.050	1.950 - 2.400	16	2.400	5	<b>234942</b>
			50	8	1.050	1.950 - 2.400	16	2.400	5	<b>234943</b>
			55	8	1.050	1.950 - 2.400	16	2.400	5	<b>234944</b>
			60	8	1.050	1.950 - 2.400	16	2.400	5	<b>234945</b>
			65	8	1.050	1.950 - 2.400	16	2.400	5	<b>234946</b>
										<b>234947</b>

**Flat faceplate 20 mm**

234965



**5.3.1.2 Door lock G-TS Module PT-M with 2 HO-BO and 2 i.S. E92 F-20**



extendable	silver	92	28	8	1.050	1.950 - 2.400	20	2.400	5	<b>No</b>
			35	8	1.050	1.950 - 2.400	20	2.400	5	<b>234960</b>
			40	8	1.050	1.950 - 2.400	20	2.400	5	<b>234961</b>
			45	8	1.050	1.950 - 2.400	20	2.400	5	<b>234962</b>
			50	8	1.050	1.950 - 2.400	20	2.400	5	<b>234963</b>
			55	8	1.050	1.950 - 2.400	20	2.400	5	<b>234964</b>
			60	8	1.050	1.950 - 2.400	20	2.400	5	<b>234965</b>
			65	8	1.050	1.950 - 2.400	20	2.400	5	<b>234966</b>
										<b>234967</b>

**Top hat faceplate 24/16 mm**

234995



**5.3.1.3 Door lock G-TS Module PT-M with 2 HO-BO and 2 i.S. E92 F-24/16**



extendable	silver	92	28	8	1.050	1.950 - 2.400	24/16	2.400	5	<b>No</b>
			35	8	1.050	1.950 - 2.400	24/16	2.400	5	<b>234990</b>
			40	8	1.050	1.950 - 2.400	24/16	2.400	5	<b>234991</b>
			45	8	1.050	1.950 - 2.400	24/16	2.400	5	<b>234992</b>
			50	8	1.050	1.950 - 2.400	24/16	2.400	5	<b>234993</b>
			55	8	1.050	1.950 - 2.400	24/16	2.400	5	<b>234994</b>
			60	8	1.050	1.950 - 2.400	24/16	2.400	5	<b>234995</b>
			65	8	1.050	1.950 - 2.400	24/16	2.400	5	<b>234996</b>
										<b>234997</b>

## 5.4 Door lock G-TS Module with HO-BO









### 5.4.1 Door lock G-TS with 2 HO-BO

#### Flat faceplate 16 mm

233445



#### 5.4.1.1 Door lock G-TS Module PT-M with 2 HO-BO E92 F-16









											<b>No</b>
modular	silver	92	28	8	1.050	1.900 - 2.400	16	2.400	5		<b>233440</b>
				10	1.050	1.900 - 2.400	16	2.400	5		<b>233450</b>
				35	1.050	1.900 - 2.400	16	2.400	5		<b>233441</b>
				10	1.050	1.900 - 2.400	16	2.400	5		<b>233451</b>
				40	1.050	1.900 - 2.400	16	2.400	5		<b>233442</b>
				10	1.050	1.950 - 2.400	16	2.400	5		<b>233452</b>
				45	1.050	1.900 - 2.400	16	2.400	5		<b>233443</b>
				10	1.050	1.950 - 2.400	16	2.400	5		<b>233453</b>
				50	1.050	1.900 - 2.400	16	2.400	5		<b>233444</b>
				10	1.050	1.950 - 2.400	16	2.400	5		<b>233454</b>
				55	1.050	1.900 - 2.400	16	2.400	5		<b>233445</b>
				10	1.050	1.950 - 2.400	16	2.400	5		<b>233455</b>
				60	1.050	1.900 - 2.400	16	2.400	5		<b>233446</b>
				10	1.050	1.950 - 2.400	16	2.400	5		<b>233456</b>
				65	1.050	1.900 - 2.400	16	2.400	5		<b>233447</b>
				10	1.050	1.950 - 2.400	16	2.400	5		<b>233457</b>

#### Flat faceplate 20 mm

233865



#### 5.4.1.2 Door lock G-TS Module PT-M with 2 HO-BO E92 F-20

											<b>No</b>
modular	silver	92	28	8	1.050	1.950 - 2.400	20	2.400	5		<b>233860</b>
				35	1.050	1.950 - 2.400	20	2.400	5		<b>233861</b>
				10	1.050	1.950 - 2.400	20	2.400	5		<b>233941</b>
				40	1.050	1.950 - 2.400	20	2.400	5		<b>233862</b>
				10	1.050	1.950 - 2.400	20	2.400	5		<b>233942</b>
				45	1.050	1.950 - 2.400	20	2.400	5		<b>233863</b>
				10	1.050	1.950 - 2.400	20	2.400	5		<b>233943</b>
				50	1.050	1.950 - 2.400	20	2.400	5		<b>233864</b>
				10	1.050	1.950 - 2.400	20	2.400	5		<b>233944</b>
				55	1.050	1.950 - 2.400	20	2.400	5		<b>233865</b>
				10	1.050	1.950 - 2.400	20	2.400	5		<b>233945</b>
				60	1.050	1.950 - 2.400	20	2.400	5		<b>233866</b>
				10	1.050	1.950 - 2.400	20	2.400	5		<b>233946</b>
				65	1.050	1.950 - 2.400	20	2.400	5		<b>233867</b>
				10	1.050	1.950 - 2.400	20	2.400	5		<b>233947</b>

Top hat faceplate 24/16 mm

234895



5.4.1.3 Door lock G-TS Module PT-M with 2 HO-BO E92 F-24/16



modular	silver	92						L		No
		28	8	1.050	1.950 - 2.400	24/16	2.400	5		<b>234890</b>
		35	8	1.050	1.950 - 2.400	24/16	2.400	5		<b>234891</b>
			10	1.050	1.950 - 2.400	24/16	2.400	5		<b>241931</b>
		40	8	1.050	1.950 - 2.400	24/16	2.400	5		<b>234892</b>
			10	1.050	1.950 - 2.400	24/16	2.400	5		<b>241932</b>
		45	8	1.050	1.950 - 2.400	24/16	2.400	5		<b>234893</b>
			10	1.050	1.950 - 2.400	24/16	2.400	5		<b>241933</b>
		50	8	1.050	1.950 - 2.400	24/16	2.400	5		<b>234894</b>
			10	1.050	1.950 - 2.400	24/16	2.400	5		<b>241934</b>
		55	8	1.050	1.950 - 2.400	24/16	2.400	5		<b>234895</b>
			10	1.050	1.950 - 2.400	24/16	2.400	5		<b>241935</b>
		60	8	1.050	1.950 - 2.400	24/16	2.400	5		<b>234896</b>
			10	1.050	1.950 - 2.400	24/16	2.400	5		<b>241936</b>
		65	8	1.050	1.950 - 2.400	24/16	2.400	5		<b>234897</b>
			10	1.050	1.950 - 2.400	24/16	2.400	5		<b>241937</b>

U-faceplate 6x24x6 mm

236845

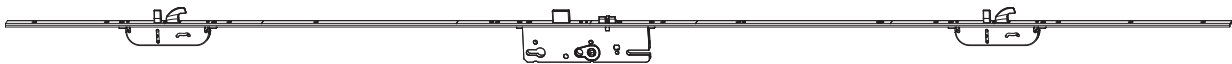

5.4.1.4 Door lock G-TS Module PT-M with 2 HO-BO E92 U-6x24x6



modular	silver	92						L		No
		28	8	1.050	1.950 - 2.400	24	2.200	5		<b>236840</b>
		35	8	1.050	1.950 - 2.400	24	2.200	5		<b>236841</b>
		40	8	1.050	1.950 - 2.400	24	2.200	5		<b>236842</b>
		45	8	1.050	1.950 - 2.400	24	2.200	5		<b>236843</b>
		50	8	1.050	1.950 - 2.400	24	2.200	5		<b>236844</b>
		55	8	1.050	1.950 - 2.400	24	2.200	5		<b>236845</b>
		60	8	1.050	1.950 - 2.400	24	2.200	5		<b>236846</b>
		65	8	1.050	1.950 - 2.400	24	2.200	5		<b>236847</b>

Flat faceplate 16 mm

233675



5.4.1.5 Door lock G-TS Module PT-M with 2 HO-BO E94 F-16







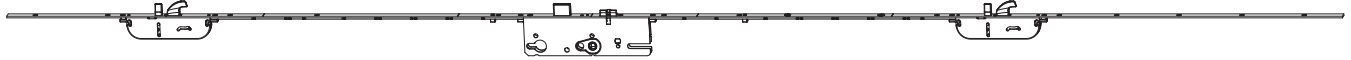

modular	silver	94						L		No
		35	9	1.050	1.950 - 2.400	16	2.400	5		<b>233671</b>
		40	9	1.050	1.950 - 2.400	16	2.400	5		<b>233672</b>
		45	9	1.050	1.950 - 2.400	16	2.400	5		<b>233673</b>
		50	9	1.050	1.950 - 2.400	16	2.400	5		<b>233674</b>
		55	9	1.050	1.950 - 2.400	16	2.400	5		<b>233675</b>
		60	9	1.050	1.950 - 2.400	16	2.400	5		<b>233676</b>
		65	9	1.050	1.950 - 2.400	16	2.400	5		<b>233677</b>

## Flat faceplate 20 mm

233755









5.4.1.6 Door lock G-TS Module PT-M with 2 HO-BO E94 F-20									No	
modular	silver	94	35	9	1.050	1.950 - 2.400	20	2.400	5	<b>233751</b>
			40	9	1.050	1.950 - 2.400	20	2.400	5	<b>233752</b>
			45	9	1.050	1.950 - 2.400	20	2.400	5	<b>233753</b>
			50	9	1.050	1.950 - 2.400	20	2.400	5	<b>233754</b>
			55	9	1.050	1.950 - 2.400	20	2.400	5	<b>233755</b>
			60	9	1.050	1.950 - 2.400	20	2.400	5	<b>233756</b>
			65	9	1.050	1.950 - 2.400	20	2.400	5	<b>233757</b>

## Top hat faceplate 24/16 mm

240285









5.4.1.7 Door lock G-TS Module PT-M with 2 HO-BO E94 F-24/16									No	
modular	silver	94	35	9	1.050	1.950 - 2.400	24/16	2.400	5	<b>240281</b>
			40	9	1.050	1.950 - 2.400	24/16	2.400	5	<b>240282</b>
			45	9	1.050	1.950 - 2.400	24/16	2.400	5	<b>240283</b>
			50	9	1.050	1.950 - 2.400	24/16	2.400	5	<b>240284</b>
			55	9	1.050	1.950 - 2.400	24/16	2.400	5	<b>240285</b>
			60	9	1.050	1.950 - 2.400	24/16	2.400	5	<b>240286</b>
			65	9	1.050	1.950 - 2.400	24/16	2.400	5	<b>240287</b>

## 5.4.2 Door lock G-TS with 4 HO-BO

### Flat faceplate 16 mm

235295



5.4.2.1 Door lock G-TS Module PT-M with 4 HO-BO E92 F-16									No
silver	92	28	8	1.050	1.950 - 2.400	16	2.400	5	<b>235290</b>
		35	8	1.050	1.950 - 2.400	16	2.400	5	<b>235291</b>
		40	8	1.050	1.950 - 2.400	16	2.400	5	<b>235292</b>
		45	8	1.050	1.950 - 2.400	16	2.400	5	<b>235293</b>
		50	8	1.050	1.950 - 2.400	16	2.400	5	<b>235294</b>
		55	8	1.050	1.950 - 2.400	16	2.400	5	<b>235295</b>
		60	8	1.050	1.950 - 2.400	16	2.400	5	<b>235296</b>
		65	8	1.050	1.950 - 2.400	16	2.400	5	<b>235297</b>

Flat faceplate 20 mm

234925

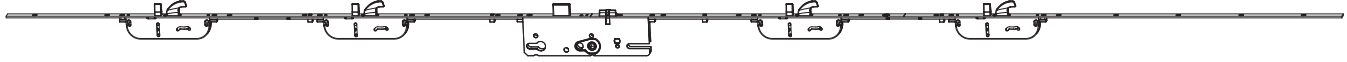

5.4.2.2 Door lock G-TS Module PT-M  
with 4 HO-BO E92 F-20



	92						L		No
silver	28	8	1.050	1.950 - 2.400	20	2.400	5	<b>234920</b>	
	35	8	1.050	1.950 - 2.400	20	2.400	5	<b>234921</b>	
	40	8	1.050	1.950 - 2.400	20	2.400	5	<b>234922</b>	
	45	8	1.050	1.950 - 2.400	20	2.400	5	<b>234923</b>	
	50	8	1.050	1.950 - 2.400	20	2.400	5	<b>234924</b>	
	55	8	1.050	1.950 - 2.400	20	2.400	5	<b>234925</b>	
	60	8	1.050	1.950 - 2.400	20	2.400	5	<b>234926</b>	
	65	8	1.050	1.950 - 2.400	20	2.400	5	<b>234927</b>	

Top hat faceplate 24/16 mm

234935



5.4.2.3 Door lock G-TS Module PT-M  
with 4 HO-BO E92 F-24/16



	92						L		No
silver	28	8	1.050	1.950 - 2.400	24/16	2.400	5	<b>234930</b>	
	35	8	1.050	1.950 - 2.400	24/16	2.400	5	<b>234931</b>	
	40	8	1.050	1.950 - 2.400	24/16	2.400	5	<b>234932</b>	
	45	8	1.050	1.950 - 2.400	24/16	2.400	5	<b>234933</b>	
	50	8	1.050	1.950 - 2.400	24/16	2.400	5	<b>234934</b>	
	55	8	1.050	1.950 - 2.400	24/16	2.400	5	<b>234935</b>	
	60	8	1.050	1.950 - 2.400	24/16	2.400	5	<b>234936</b>	
	65	8	1.050	1.950 - 2.400	24/16	2.400	5	<b>234937</b>	

**5.5 Door lock G-TS Module with HO and i.S.**

**5.5.1 Door lock G-TS with 2 HO and 2 i.S.**

**Flat faceplate 16 mm**

234955



5.5.1.1 Door lock G-TS Module PT-M with 2 HO and 2 i.S E92 F-16									No	
extendable	silver	92	28	8	1.050	1.950 - 2.400	16	2.400	5	<b>234950</b>
			35	8	1.050	1.950 - 2.400	16	2.400	5	<b>234951</b>
			40	8	1.050	1.950 - 2.400	16	2.400	5	<b>234952</b>
			45	8	1.050	1.950 - 2.400	16	2.400	5	<b>234953</b>
			50	8	1.050	1.950 - 2.400	16	2.400	5	<b>234954</b>
			55	8	1.050	1.950 - 2.400	16	2.400	5	<b>234955</b>
			60	8	1.050	1.950 - 2.400	16	2.400	5	<b>234956</b>
			65	8	1.050	1.950 - 2.400	16	2.400	5	<b>234957</b>

**Flat faceplate 20 mm**

234985



5.5.1.2 Door lock G-TS Module PT-M with 2 HO and 2 i.S E92 F-20									No	
extendable	silver	92	28	8	1.050	1.950 - 2.400	20	2.400	5	<b>234980</b>
			35	8	1.050	1.950 - 2.400	20	2.400	5	<b>234981</b>
			40	8	1.050	1.950 - 2.400	20	2.400	5	<b>234982</b>
			45	8	1.050	1.950 - 2.400	20	2.400	5	<b>234983</b>
			50	8	1.050	1.950 - 2.400	20	2.400	5	<b>234984</b>
			55	8	1.050	1.950 - 2.400	20	2.400	5	<b>234985</b>
			60	8	1.050	1.950 - 2.400	20	2.400	5	<b>234986</b>
			65	8	1.050	1.950 - 2.400	20	2.400	5	<b>234987</b>

**Top hat faceplate 24/16 mm**

235015



5.5.1.3 Door lock G-TS Module PT-M with 2 HO and 2 i.S E92 F-24/16									No	
extendable	silver	92	28	8	1.050	1.950 - 2.400	24/16	2.400	5	<b>235010</b>
			35	8	1.050	1.950 - 2.400	24/16	2.400	5	<b>235011</b>
			40	8	1.050	1.950 - 2.400	24/16	2.400	5	<b>235012</b>
			45	8	1.050	1.950 - 2.400	24/16	2.400	5	<b>235013</b>
			50	8	1.050	1.950 - 2.400	24/16	2.400	5	<b>235014</b>
			55	8	1.050	1.950 - 2.400	24/16	2.400	5	<b>235015</b>
			60	8	1.050	1.950 - 2.400	24/16	2.400	5	<b>235016</b>
			65	8	1.050	1.950 - 2.400	24/16	2.400	5	<b>235017</b>

**5.6 Door lock G-TS Module with HO**

**5.6.1 Door lock G-TS with 2 HO**

**Flat faceplate 16 mm**

236835



**5.6.1.1 Door lock G-TS Module PT-M with 2 HO E92 F-16**



extendable	silver	92	28	8	1.050	1.950 - 2.400	16	2.400	5	<b>236830</b>
			35	8	1.050	1.950 - 2.400	16	2.400	5	<b>236831</b>
			40	8	1.050	1.950 - 2.400	16	2.400	5	<b>236832</b>
			45	8	1.050	1.950 - 2.400	16	2.400	5	<b>236833</b>
			50	8	1.050	1.950 - 2.400	16	2.400	5	<b>236834</b>
			55	8	1.050	1.950 - 2.400	16	2.400	5	<b>236835</b>
			60	8	1.050	1.950 - 2.400	16	2.400	5	<b>236836</b>
			65	8	1.050	1.950 - 2.400	16	2.400	5	<b>236837</b>

**Flat faceplate 20 mm**

234885



**5.6.1.2 Door lock G-TS Module PT-M with 2 HO E92 F-20**



extendable	silver	92	28	8	1.050	1.950 - 2.400	20	2.400	5	<b>234880</b>
			35	8	1.050	1.950 - 2.400	20	2.400	5	<b>234881</b>
			40	8	1.050	1.950 - 2.400	20	2.400	5	<b>234882</b>
			45	8	1.050	1.950 - 2.400	20	2.400	5	<b>234883</b>
			50	8	1.050	1.950 - 2.400	20	2.400	5	<b>234884</b>
			55	8	1.050	1.950 - 2.400	20	2.400	5	<b>234885</b>
			60	8	1.050	1.950 - 2.400	20	2.400	5	<b>234886</b>
			65	8	1.050	1.950 - 2.400	20	2.400	5	<b>234887</b>

**Top hat faceplate 24/16 mm**

234915



**5.6.1.3 Door lock G-TS Module PT-M with 2 HO E92 F-24/16**







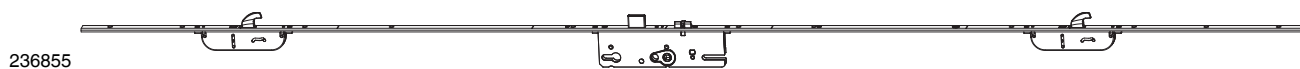

extendable	silver	92	28	8	1.050	1.950 - 2.400	24/16	2.400	5	<b>234910</b>
			35	8	1.050	1.950 - 2.400	24/16	2.400	5	<b>234911</b>
			40	8	1.050	1.950 - 2.400	24/16	2.400	5	<b>234912</b>
			45	8	1.050	1.950 - 2.400	24/16	2.400	5	<b>234913</b>
			50	8	1.050	1.950 - 2.400	24/16	2.400	5	<b>234914</b>
			55	8	1.050	1.950 - 2.400	24/16	2.400	5	<b>234915</b>
			60	8	1.050	1.950 - 2.400	24/16	2.400	5	<b>234916</b>
			65	8	1.050	1.950 - 2.400	24/16	2.400	5	<b>234917</b>

5

## U-faceplate 6x24x6 mm



236855

5.6.1.4 Door lock G-TS Module PT-M with 2 HO E92 6x24x6 HH 1050								L		No
modular	silver	92	28	8	1.050	1.950 - 2.400	24	2.200	5	<b>236850</b>
			35	8	1.050	1.950 - 2.400	24	2.200	5	<b>236851</b>
			40	8	1.050	1.950 - 2.400	24	2.200	5	<b>236852</b>
			45	8	1.050	1.950 - 2.400	24	2.200	5	<b>236853</b>
			50	8	1.050	1.950 - 2.400	24	2.200	5	<b>236854</b>
			55	8	1.050	1.950 - 2.400	24	2.200	5	<b>236855</b>
			60	8	1.050	1.950 - 2.400	24	2.200	5	<b>236856</b>
			65	8	1.050	1.950 - 2.400	24	2.200	5	<b>236857</b>

## 5.7 Door lock G-TS Module with BO and i.S.

### 5.7.1 Door lock G-TS with 2 BO and 2 i.S.

#### Flat faceplate 16 mm

236825



#### 5.7.1.1 Door lock G-TS Module PT-M with 2 BO and 2 i.S E92 F-16



extendable	silver	92	28	8	1.050	1.950 - 2.400	16	2.400	5	No
			35	8	1.050	1.950 - 2.400	16	2.400	5	<b>236820</b>
			40	8	1.050	1.950 - 2.400	16	2.400	5	<b>236821</b>
			45	8	1.050	1.950 - 2.400	16	2.400	5	<b>236822</b>
			50	8	1.050	1.950 - 2.400	16	2.400	5	<b>236823</b>
			55	8	1.050	1.950 - 2.400	16	2.400	5	<b>236824</b>
			60	8	1.050	1.950 - 2.400	16	2.400	5	<b>236825</b>
			65	8	1.050	1.950 - 2.400	16	2.400	5	<b>236826</b>
										<b>236827</b>

#### Flat faceplate 20 mm

234975



#### 5.7.1.2 Door lock G-TS Module PT-M with 2 BO and 2 i.S E92 F-20



extendable	silver	92	28	8	1.050	1.950 - 2.400	20	2.400	5	No
			35	8	1.050	1.950 - 2.400	20	2.400	5	<b>234970</b>
			40	8	1.050	1.950 - 2.400	20	2.400	5	<b>234971</b>
			45	8	1.050	1.950 - 2.400	20	2.400	5	<b>234972</b>
			50	8	1.050	1.950 - 2.400	20	2.400	5	<b>234973</b>
			55	8	1.050	1.950 - 2.400	20	2.400	5	<b>234974</b>
			60	8	1.050	1.950 - 2.400	20	2.400	5	<b>234975</b>
			65	8	1.050	1.950 - 2.400	20	2.400	5	<b>234976</b>
										<b>234977</b>

#### Top hat faceplate 24/16 mm

235005



#### 5.7.1.3 Door lock G-TS Module PT-M with 2 BO and 2 i.S E92 F-24/16







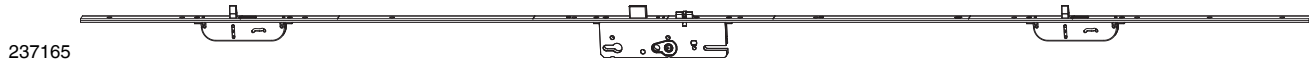

extendable	silver	92	28	8	1.050	1.950 - 2.400	24/16	2.400	5	No
			35	8	1.050	1.950 - 2.400	24/16	2.400	5	<b>235000</b>
			40	8	1.050	1.950 - 2.400	24/16	2.400	5	<b>235001</b>
			45	8	1.050	1.950 - 2.400	24/16	2.400	5	<b>235002</b>
			50	8	1.050	1.950 - 2.400	24/16	2.400	5	<b>235003</b>
			55	8	1.050	1.950 - 2.400	24/16	2.400	5	<b>235004</b>
			60	8	1.050	1.950 - 2.400	24/16	2.400	5	<b>235005</b>
			65	8	1.050	1.950 - 2.400	24/16	2.400	5	<b>235006</b>
										<b>235007</b>



## U-faceplate 6x24x6 mm









237165

5.8.1.4 Door lock G-TS Module PT-M with 2 BO E92 U-6x24x6							L		No	
modular	silver	92	28	8	1.050	1.950 - 2.400	24	2.200	5	<b>237160</b>
			35	8	1.050	1.950 - 2.400	24	2.200	5	<b>237161</b>
			40	8	1.050	1.950 - 2.400	24	2.200	5	<b>237162</b>
			45	8	1.050	1.950 - 2.400	24	2.200	5	<b>237163</b>
			50	8	1.050	1.950 - 2.400	24	2.200	5	<b>237164</b>
			55	8	1.050	1.950 - 2.400	24	2.200	5	<b>237165</b>
			60	8	1.050	1.950 - 2.400	24	2.200	5	<b>237166</b>
			65	8	1.050	1.950 - 2.400	24	2.200	5	<b>237167</b>

## Flat faceplate 16 mm

240795







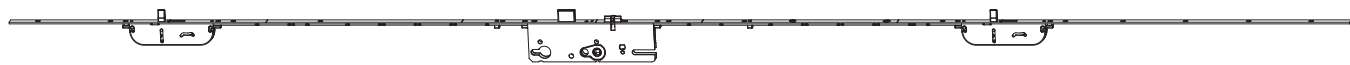

5.8.1.5 Door lock G-TS Module PT-M with 2 BO E94 F-16							L		No	
modular	silver	94	35	9	1.050	1.950 - 2.400	16	2.400	5	<b>240791</b>
			40	9	1.050	1.950 - 2.400	16	2.400	5	<b>240792</b>
			45	9	1.050	1.950 - 2.400	16	2.400	5	<b>240793</b>
			50	9	1.050	1.950 - 2.400	16	2.400	5	<b>240794</b>
			55	9	1.050	1.950 - 2.400	16	2.400	5	<b>240795</b>
			60	9	1.050	1.950 - 2.400	16	2.400	5	<b>240796</b>
			65	9	1.050	1.950 - 2.400	16	2.400	5	<b>240797</b>

## Flat faceplate 20 mm

240805



5.8.1.6 Door lock G-TS Module PT-M with 2 BO E94 F-20							L		No	
modular	silver	94	35	9	1.050	1.950 - 2.400	20	2.400	5	<b>240801</b>
			40	9	1.050	1.950 - 2.400	20	2.400	5	<b>240802</b>
			45	9	1.050	1.950 - 2.400	20	2.400	5	<b>240803</b>
			50	9	1.050	1.950 - 2.400	20	2.400	5	<b>240804</b>
			55	9	1.050	1.950 - 2.400	20	2.400	5	<b>240805</b>
			60	9	1.050	1.950 - 2.400	20	2.400	5	<b>240806</b>
			65	9	1.050	1.950 - 2.400	20	2.400	5	<b>240807</b>

**Top hat faceplate 24/16 mm**

240815



**5.8.1.7 Door lock G-TS Module PT-M  
with 2 BO E94 F-24/16**



modular	silver	94						L		No
			35	9	1.050	1.950 - 2.400	24/16	2.400	5	<b>240811</b>
			40	9	1.050	1.950 - 2.400	24/16	2.400	5	<b>240812</b>
			45	9	1.050	1.950 - 2.400	24/16	2.400	5	<b>240813</b>
			50	9	1.050	1.950 - 2.400	24/16	2.400	5	<b>240814</b>
			55	9	1.050	1.950 - 2.400	24/16	2.400	5	<b>240815</b>
			60	9	1.050	1.950 - 2.400	24/16	2.400	5	<b>240816</b>
			65	9	1.050	1.950 - 2.400	24/16	2.400	5	<b>240817</b>

**U-faceplate 6x24x6 mm**

237174

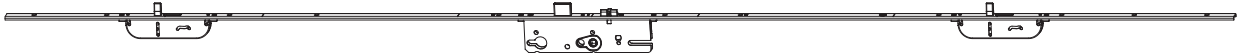

**5.8.1.8 Door lock G-TS Module PT-M  
with 2 BO E94 U-6x24x6**



modular	silver	94						L		No
			45	9	1.050	1.950 - 2.400	24	2.200	5	<b>237173</b>
			50	9	1.050	1.950 - 2.400	24	2.200	5	<b>237174</b>

## 5.9 Door lock G-TS Module without i.S.

Flat faceplate 16 mm

### 5.9.1 Door lock G-TS without i.S.

233485

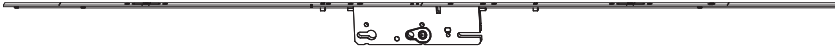

#### 5.9.1.1 Door lock G-TS Module PT-M without i.S. E92 F-16



2-sashed	silver	92						L		No
			28	8	1.050	1.900 - 2.500	16	1.500	5	<b>233480</b>
			35	8	1.050	1.900 - 2.500	16	1.500	5	<b>233481</b>
			40	8	1.050	1.900 - 2.500	16	1.500	5	<b>233482</b>
			45	8	1.050	1.900 - 2.500	16	1.500	5	<b>233483</b>
			50	8	1.050	1.900 - 2.500	16	1.500	5	<b>233484</b>
			55	8	1.050	1.900 - 2.500	16	1.500	5	<b>233485</b>
			60	8	1.050	1.900 - 2.500	16	1.500	5	<b>233486</b>
			65	8	1.050	1.900 - 2.500	16	1.500	5	<b>233487</b>

**MACO  
PROTECT**



## G-TS Lever operated Door Lock



## **6 G-TA Lever Operated Automatic Door Lock**

---

<b>6.1</b>	<b>Door lock G-TA with i.S</b>	<b>136</b>
6.1.1	Door lock G-TA with 4 i.S	136

## 6 G-TA Lever Operated Automatic Door Lock





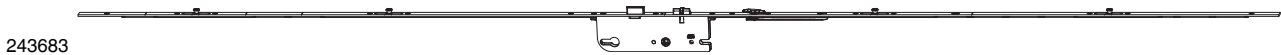

### 6.1 Door lock G-TA with i.S

#### 6.1.1 Door lock G-TA with 4 i.S

##### Flat faceplate 16 mm







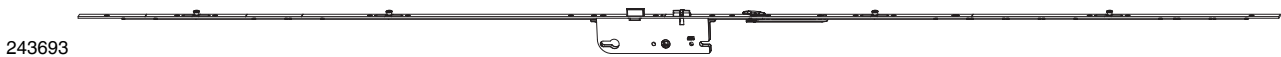

#### 6.1.1.1 Door lock G-TA with 4 i.S E92 F-16

								<b>L</b>		<b>No</b>
extendable	silver	92	28	8	1.050	1.950 - 2.150	16	2.150	5	<b>243680</b>
			35	8	1.050	1.950 - 2.150	16	2.150	5	<b>243681</b>
			40	8	1.050	1.950 - 2.150	16	2.150	5	<b>243682</b>
			45	8	1.050	1.950 - 2.150	16	2.150	5	<b>243683</b>
			50	8	1.050	1.950 - 2.150	16	2.150	5	<b>243684</b>

##### Top hat faceplate 24/16 mm



#### 6.1.1.2 Door lock G-TA with 4 i.S E92 F-24/6

								<b>L</b>		<b>No</b>
extendable	silver	92	28	8	1.050	1.950 - 2.150	24/16	2.150	5	<b>243690</b>
			35	8	1.050	1.950 - 2.150	24/16	2.150	5	<b>243691</b>
			40	8	1.050	1.950 - 2.150	24/16	2.150	5	<b>243692</b>
			45	8	1.050	1.950 - 2.150	24/16	2.150	5	<b>243693</b>
			50	8	1.050	1.950 - 2.150	24/16	2.150	5	<b>243694</b>



## 7 C-TS Combined Lever and Split Spindle Door Lock

---

<b>7.1</b>	<b>Door lock C-TS with HO</b>	<b>138</b>
7.1.1	Door lock C-TS with 2 hooks	138
<b>7.2</b>	<b>Door lock C-TS with HO-VZ</b>	<b>139</b>
7.2.1	Door lock C-TS with 2 hooks-VZ	139
<b>7.3</b>	<b>Door lock C-TS with HO-VZ + VZ</b>	<b>140</b>
7.3.1	Door lock C-TS with 2 HO-VZ + 2 VZ	140
<b>7.4</b>	<b>Door lock C-TS with HO-BO</b>	<b>141</b>
7.4.1	Door lock C-TS with 2 HO-BO	141
<b>7.5</b>	<b>Door lock C-TS with HO-BO and i.S.</b>	<b>142</b>
7.5.1	Door lock C-TS with 2 HO-BO + 2 i.S. E92 F-16	142
<b>7.6</b>	<b>Door lock C-TS Module Mullionless with HO</b>	<b>143</b>
7.6.1	Door lock C-TS Mullionless with 2 HO	143





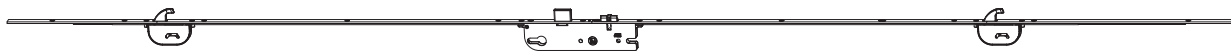

## 7 C-TS Combined Lever and Split Spindle Door Lock

### 7.1 Door lock C-TS with HO







#### 7.1.1 Door lock C-TS with 2 hooks

##### Flat faceplate 16 mm







242351 

7.1.1.1 Door lock C-TS with 2 HO E92 F-16									No	
fixed handle height	silver	92	35	8	1.050	1.950 - 2.200	16	2.200	5	242351
			45	8	1.050	1.950 - 2.200	16	2.200	5	242353

244111 







7.1.1.2 Door lock C-TS with 2 HO E92 F-16 2-sashed									No	
2-sashed	silver	92	35	8	1.050	1.800 - 2.200	16	1.800	5	244111
			45	8	1.050	1.800 - 2.200	16	1.800	5	244113

244361 







7.1.1.3 Door lock C-TS with 2 HO E92 F-16 2-sashed with offset latch									No	
2-sashed offset latch	silver	92	35	8	1.050	1.800 - 2.200	16	1.800	5	244361
			45	8	1.050	1.800 - 2.200	16	1.800	5	244363

##### Flat faceplate 20 mm

242361 

7.1.1.4 Door lock C-TS with 2 HO E92 F-20									No	
fixed handle height	silver	92	35	8	1.050	1.950 - 2.200	20	2.200	5	242361
			45	8	1.050	1.950 - 2.200	20	2.200	5	242363

244371 

7.1.1.5 Door lock C-TS with 2 HO E92 F-20 2-sashed with offset latch									No	
2-sashed offset latch	silver	92	35	8	1.050	1.800 - 2.200	20	1.800	5	244371
			45	8	1.050	1.800 - 2.200	20	1.800	5	244373









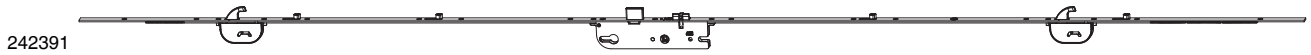

## 7.3 Door lock C-TS with HO-VZ + VZ

### 7.3.1 Door lock C-TS with 2 HO-VZ + 2 VZ

#### Flat faceplate 16 mm









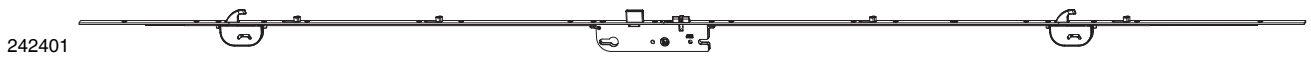

#### 7.3.1.1 Door lock C-TS with 2 HO-VZ + 2 VZ E92 F-16

										
fixed handle height	silver	92	35	8	1.050	1.950 - 2.200	16	2.200	5	<b>242391</b>
			45	8	1.050	1.950 - 2.200	16	2.200	5	<b>242393</b>

#### Flat faceplate 20 mm



#### 7.3.1.2 Door lock C-TS with 2 HO-VZ + 2 VZ E92 F-20

										
fixed handle height	silver	92	35	8	1.050	1.950 - 2.200	20	2.200	5	<b>242401</b>
			45	8	1.050	1.950 - 2.200	20	2.200	5	<b>242403</b>

**7.4 Door lock C-TS with HO-BO**

**7.4.1 Door lock C-TS with 2 HO-BO**

**Flat faceplate 20 mm**



7.4.1.1 Door lock C-TS with 2HO-BO E92 20R L-1750								<b>L</b>		<b>No</b>
fixed handle height	silver	92	35	8	890	1.950 - 2.400	20 / R	1.750	5	<b>243641</b>
			45	8	890	1.950 - 2.400	20 / R	1.750	5	<b>243643</b>

**Top hat faceplate 24/16 mm**

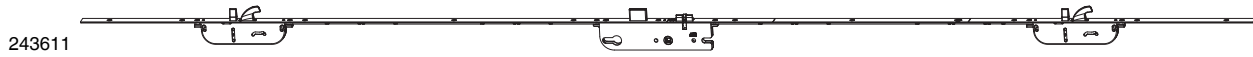

7.4.1.2 Door lock C-TS with 2 HO-BO E92 F-24/16								<b>L</b>		<b>No</b>
fixed handle height	silver	92	35	8	1.050	1.950 - 2.400	24/16	2.100	5	<b>243611</b>
			45	8	1.050	1.950 - 2.400	24/16	2.100	5	<b>243613</b>

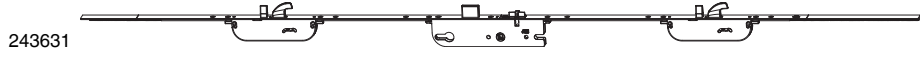

7.4.1.3 Door lock C-TS with 2 HO-BO + 2 i.S. E92 F24/16 2-sashed								<b>L</b>		<b>No</b>
2-sashed	silver	92	35	8	750	1.900 - 2.300	24/16	1.500	5	<b>243631</b>







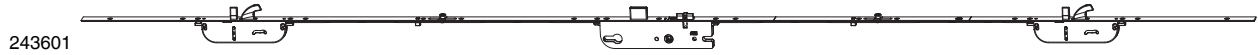

7

**7.5 Door lock C-TS with HO-BO and i.S.**

Top hat faceplate 24/16 mm

**7.5.1 Door lock C-TS with 2 HO-BO + 2 i.S. E92 F-16**



<p><b>7.5.1.1 Door lock C-TS with 2 HO-BO + 2 i.S. E92 F-24/16</b></p>										
<p>fixed handle height</p>	<p>silver</p>	<p>92</p>	<p>35</p>	<p>8</p>	<p>1.050</p>	<p>1.950 - 2.400</p>	<p>24/16</p>	<p>2.100</p>	<p>5</p>	<p><b>243601</b></p>

## 7.6 Door lock C-TS Modul Mullionless with HO

### 7.6.1 Door lock C-TS Mullionless with 2 HO

#### Flat faceplate 16 mm



244381

#### 7.6.1.1 Door lock C-TS Mullionless PT-M with 2 HO E92 F-16



extendable tab 21 mm	silver	92	35	8	1.050	1.800 - 2.200	16	1.800	5	244381
			45	8	1.050	1.800 - 2.200	16	1.800	5	244383

#### Flat faceplate 20 mm



244391

#### 7.6.1.2 Door lock C-TS Mullionless PT-M with 2 HO E92 F-20



extendable tab 21 mm	silver	92	35	8	1.050	1.800 - 2.200	20	1.800	5	244391
			45	8	1.050	1.800 - 2.200	20	1.800	5	244393

**MACO  
PROTECT**



# C-TS Combined Lever and Split Spindle Door Lock



## 8 Z-RS - Mortise Door Lock





---

<b>8.1</b>	<b>Door lock Z-RS</b>	<b>146</b>
8.1.1	Door lock Z-RS E92 F-16	146
8.1.2	Door lock Z-RS E92 F-24	146
8.1.3	Door lock Z-RS E92 U-6x24x6	146
<b>8.2</b>	<b>Door lock Z-RS with roller latch</b>	<b>147</b>
8.2.1	Door lock Z-RS with roller latch E92 F-16	147
8.2.2	Door lock Z-RS with roller latch E92 F-24	147
8.2.3	Door lock Z-RS with roller latch E92 U-6x24x6	147

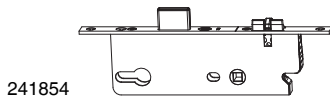



## 8 Z-RS - Mortise Door Lock

### 8.1 Door lock Z-RS

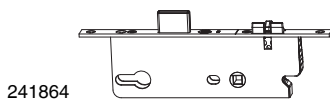





8.1.1 Door lock Z-RS E92 F-16					L		No
silver	92	25	8	16	240	10	241850
		35	8	16	240	10	241852
		45	8	16	240	10	241854

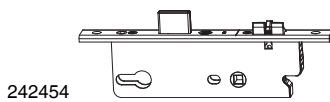

8.1.2 Door lock Z-RS E92 F-24					L		No
silver	92	25	8	24	240	10	241860
		35	8	24	240	10	241862
		45	8	24	240	10	241864



8.1.3 Door lock Z-RS E92 U-6x24x6					L		No
silver	92	25	8	24	240	10	242450
		35	8	24	240	10	242452
		45	8	24	240	10	242454

**8.2 Door lock Z-RS with roller latch**

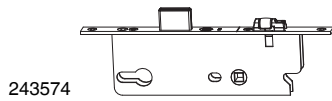

**8.2.1 Door lock Z-RS with roller latch E92 F-16**



with roller latch	silver	92	25	8	16	240	10	<b>243570</b>
			35	8	16	240	10	<b>243572</b>
			45	8	16	240	10	<b>243574</b>

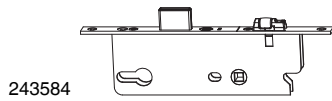

**8.2.2 Door lock Z-RS with roller latch E92 F-24**



with roller latch	silver	92	25	8	24	240	10	<b>243580</b>
			35	8	24	240	10	<b>243582</b>
			45	8	24	240	10	<b>243584</b>

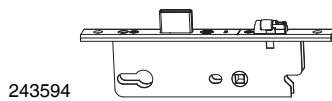

**8.2.3 Door lock Z-RS with roller latch E92 U-6x24x6**



silver		92	25	8	24	240	10	<b>243590</b>
			35	8	24	240	10	<b>243592</b>
			45	8	24	240	10	<b>243594</b>

**MACO  
PROTECT**



**Z-RS - Mortise Door Lock**



## 9 B-TV - Balcony Door Lock

---

<b>9.1</b>	<b>Door lock B-TV MULTI MATIC</b>	<b>150</b>
9.1.1	Door lock B-TV MULTI MATIC PC	150
9.1.2	Door lock B-TV MULTI MATIC RC	150
<b>9.2</b>	<b>Door lock B-TV MULTI TREND</b>	<b>151</b>
9.2.1	Door lock B-TV with i.S. PC extendable	151
9.2.2	Door lock B-TV with i.S. RC extendable	151
9.2.3	Door lock B-TV with VZ PC extendable	151
9.2.4	Door lock B-TV with VZ RC extendable	152
9.2.5	Door lock B-TV with i.S. PC FHH	152

## 9 B-TV - Balcony Door Lock

### 9.1 Door lock B-TV MULTI MATIC

#### 9.1.1 Door lock B-TV MULTI MATIC PC



203834

##### 9.1.1.1 Door lock B-TV MULTI MATIC PC E85

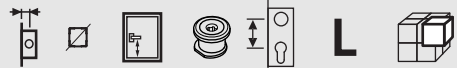

silver	MM fixed handle height	28	8	1.050	2	85	1.347	5	<b>203834</b>
--------	------------------------	----	---	-------	---	----	-------	---	---------------



203833

##### 9.1.1.2 Door lock B-TV MULTI MATIC PC E92



silver	MM fixed handle height	25	8	1.050	2	92	1.347	5	<b>203828</b>
		28	8	1.050	2	92	1.347	5	<b>203696</b>
		35	8	1.050	2	92	1.347	5	<b>203829</b>
		40	8	1.050	2	92	1.347	5	<b>203830</b>
		45	8	1.050	2	92	1.347	5	<b>203831</b>
		50	8	1.050	2	92	1.347	5	<b>203832</b>
		55	8	1.050	2	92	1.347	5	<b>203833</b>

#### 9.1.2 Door lock B-TV MULTI MATIC RC



203841

##### 9.1.2.1 Door lock B-TV MULTI MATIC RC E94



silver	MM fixed handle height	35	8	1.050	2	94	1.347	5	<b>203841</b>
		40	8	1.050	2	94	1.347	5	<b>203842</b>
		45	8	1.050	2	94	1.347	5	<b>203843</b>
		50	8	1.050	2	94	1.347	5	<b>203844</b>
		55	8	1.050	2	94	1.347	5	<b>203845</b>

## 9.2 Door lock B-TV MULTI TREND

### 9.2.1 Door lock B-TV with i.S. PC extendable

220298

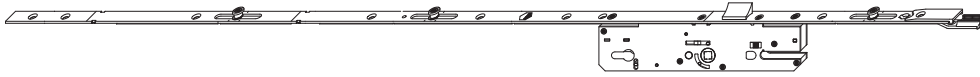

#### 9.2.1.1 Door lock B-TV with i.S. PC E92



silver	extendable								No
		25	8	1.050	3	92	1.460	5	<b>201455</b>
		28	8	1.050	3	92	1.460	5	<b>59900</b>
		35	8	1.050	3	92	1.460	5	<b>220298</b>
		40	8	1.050	3	92	1.460	5	<b>220299</b>
		45	8	1.050	3	92	1.460	5	<b>59901</b>
		50	8	1.050	3	92	1.460	5	<b>57179</b>
		55	8	1.050	3	92	1.460	5	<b>201459</b>

### 9.2.2 Door lock B-TV with i.S. RC extendable

201457

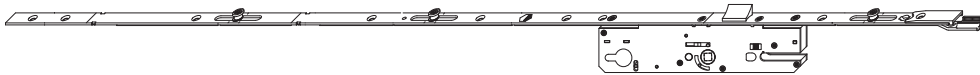

#### 9.2.2.1 Door lock B-TV with i.S. RC E94



silver	extendable								No
		28	8	1.050	3	94	1.460	5	<b>201457</b>
		35	8	1.050	3	94	1.460	5	<b>55484</b>
		40	8	1.050	3	94	1.460	5	<b>55485</b>
		45	8	1.050	3	94	1.460	5	<b>55486</b>
		50	8	1.050	3	94	1.460	5	<b>57181</b>
		55	8	1.050	3	94	1.460	5	<b>55487</b>

### 9.2.3 Door lock B-TV with VZ PC extendable

58188

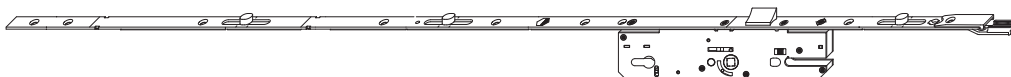

#### 9.2.3.1 Door lock B-TV with i.S. PC E92



silver	extendable								No
		25	8	1.050	3	92	1.460	5	<b>58188</b>
		28	8	1.050	3	92	1.460	5	<b>55395</b>
		35	8	1.050	3	92	1.460	5	<b>55396</b>
		40	8	1.050	3	92	1.460	5	<b>55397</b>
		45	8	1.050	3	92	1.460	5	<b>55398</b>
		55	8	1.050	3	92	1.460	5	<b>55399</b>

9.2.4 Door lock B-TV with VZ RC extendable

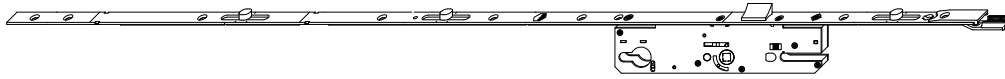

59391

9.2.4.1 Door lock B-TV with VZ RC E94



silver	extendable									No
		28	8	1.050	3	94	1.460	5		<b>59391</b>
		35	8	1.050	3	94	1.460	5		<b>55146</b>
		40	8	1.050	3	94	1.460	5		<b>55147</b>
		45	8	1.050	3	94	1.460	5		<b>55148</b>
		55	8	1.050	3	94	1.460	5		<b>55149</b>

9.2.5 Door lock B-TV with i.S. PC FHH



204048

9.2.5.1 Door lock B-TV with i.S. PC E92 FHH

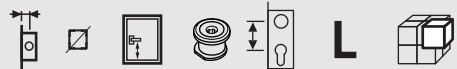

silver	fixed handle height									No
		25	8	1.050	3	92	1.460	5		<b>204060</b>
		28	8	1.050	3	92	1.460	5		<b>204048</b>
		35	8	1.050	3	92	1.460	5		<b>204049</b>
		40	8	1.050	3	92	1.460	5		<b>204050</b>
		45	8	1.050	3	92	1.460	5		<b>204051</b>
		50	8	1.050	3	92	1.460	5		<b>204052</b>
		55	8	1.050	3	92	1.460	5		<b>204053</b>



## 10 Striker plates

---

<b>10.1 Striker plates timber</b>	<b>154</b>
10.1.1 Striker plates 4mm air gap 9 mm offset	154
10.1.2 Striker plates 4 mm air gap 10 mm offset	157
10.1.3 Striker plates 4 mm air gap 13 mm offset	159
10.1.4 Striker plates 4 mm air gap 15 mm offset	161
10.1.5 Striker plates 12 mm air gap 9 mm offset	162
10.1.6 Striker plates 12 mm air gap 10 mm offset	165
10.1.7 Striker plates 12 mm air gap 13 mm offset	167
<b>10.2 Striker plates opposite hardware groove</b>	<b>170</b>
10.2.1 Latch and deadbolt striker plates	170
10.2.2 Striker plates VZ	170
10.2.3 Striker plates i.S.	170
10.2.4 Hook and bolt striker plates	170
10.2.5 Latch and deadbolt angled striker plates	170
10.2.6 Latch striker plates	170
10.2.7 Latch striker plates B-TV	170
<b>10.3 Single piece door striker for timber</b>	<b>171</b>
10.3.1 Single piece door striker for timber U-6x24x6 13 mm offset	171
10.3.2 Single piece door striker for timber U-8x28x8 13 mm offset	172
10.3.3 Single piece door striker for timber U-8x28x12 13 mm offset	172
10.3.4 Single piece door striker for timber U-10x30x10 15 mm offset	173
<b>10.4 Striker plates PVC</b>	<b>174</b>
10.4.1 Striker plates & single-piece door strikers for Z-TA automatic/comfort PT	174
10.4.2 Striker plates & single-piece door strikers for G-TS/Z-TS module PT-M	175
10.4.3 Striker plates for Z-TF PT	176
10.4.4 Single piece door strikers for Z-TF PT	177
<b>10.5 Striker plates ALU</b>	<b>178</b>
10.5.1 Striker plates ALU 3 mm	178
10.5.2 Alu 3 mm locking bar for 14 mm frame groove	178
10.5.3 Single piece door striker ALU 6 mm	178
<b>10.6 Single piece door striker for PVC</b>	<b>180</b>
10.6.1 Single piece door striker ALU 3 mm	180
10.6.2 Single piece door striker ALU 6 mm	180

## 10 Striker plates

### 10.1 Striker plates timber

#### 10.1.1 Striker plates 4mm air gap 9 mm offset



10.1.1.1 Latch and deadbolt striker plates			L	W	H		No
silver	right	latch and deadbolt striker Z-TA 4mm air gap 9mm offset	220	18	8	20	<b>219231</b>
	left	latch and deadbolt striker Z-TA 4mm air gap 9mm offset	220	18	8	20	<b>219232</b>
		latch and deadbolt striker for 4 mm air gap	208	18	8	50	<b>29776<sup>1,2</sup></b>

<sup>1</sup> Compatible with recess cover cap 43524

<sup>2</sup> Compatible with clip-on end cap 43718 for timber 12mm air gap

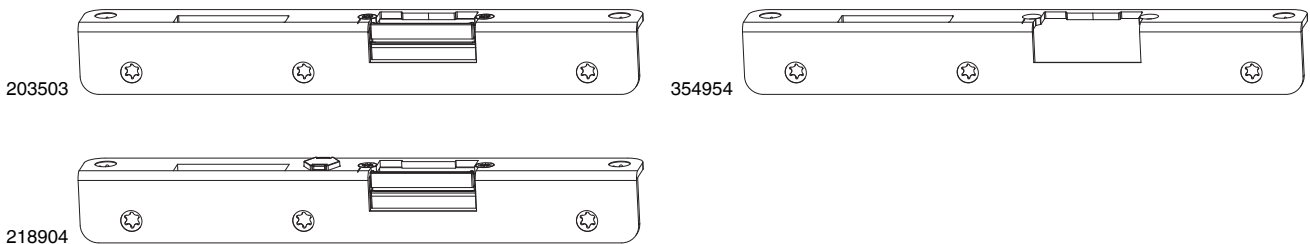

10.1.1.2 Latch and deadbolt right-angled latch plates			L			No
silver	right	right-angled latch plate for latch and deadbolt striker with receiver insert for 4 mm air gap	250	32 x 25	20	<b>203502</b>
		latch and deadbolt angled striker plate for electric opener for timber	250	32 x 25	20	<b>354952</b>
		latch and deadbolt angled striker plate for electric opener for 4 mm air gap - 1 mm gasket-compression	250	15 x 25	20	<b>360112</b>
		right-angled latch plate for latch and deadbolt striker Z-TA 4mm air gap 9mm offset	250	32 x 25	20	<b>218903</b>
	left	right-angled latch plate for latch and deadbolt striker with receiver insert for 4 mm air gap	250	32 x 25	20	<b>203503</b>
		latch and deadbolt angled striker plate for electric opener for timber	250	32 x 25	20	<b>354954</b>
		latch and deadbolt angled striker plate for electric opener for 4 mm air gap - 1 mm gasket-compression	250	15 x 25	20	<b>360113</b>
		right-angled latch plate for latch and deadbolt striker Z-TA for 4 mm air gap, 9 mm offset	250	32 x 25	20	<b>218904</b>

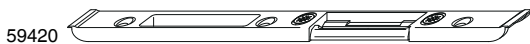

10.1.1.3 Latch and deadbolt striker plates for roller latch			L	W	H		No
silver	right	latch and deadbolt striker for roller latch for 4 mm air gap	208	18	8	50	<b>59421<sup>1,2</sup></b>
	left	latch and deadbolt striker for roller latch for 4 mm air gap	208	18	8	10	<b>59420<sup>1,2</sup></b>

<sup>1</sup> Compatible with recess cover cap 43524

<sup>2</sup> Compatible with clip-on end cap 43718 for timber 12mm air gap



10.1.1.4 Striker VZ for 4 mm air gap			L	W	H		No
silver		for 4 mm air gap	90	18	8	200	<b>30545</b>

96566

10.1.1.5 Striker i.S. for 4 mm air gap			L	W	H		No
silver	right	for 4 mm air gap - 1 mm gasket-compression	90	18	8	100	96305 <sup>1,2</sup>
		for 4 mm air gap angled screw-fixing	90	18	8	100	96565 <sup>1</sup>
	left	for 4 mm air gap - 1 mm gasket-compression	90	18	8	100	96306 <sup>1,2</sup>
		for 4 mm air gap angled screw-fixing	90	18	8	100	96566 <sup>1</sup>

<sup>1</sup> Use left-handed striker plates for right-handed doors and vice versa!

<sup>2</sup> Not compliant with EN 1627

207862

10.1.1.6 Hook and bolt striker plates			L	W	H		No
silver	hook and bolt striker for 4 mm air gap		180	18	8	20	207862 <sup>1,2</sup>

<sup>1</sup> Compatible with recess cover cap 358024

<sup>2</sup> Compatible with clip-on end cap 43718 for timber 12mm air gap

218940

10.1.1.7 Latch and deadbolt striker plates			L	W	H		No
silver	right	latch and bolt striker 4mm air gap 9mm offset	180	18	8	20	218939
	left	latch and bolt striker 4mm air gap 9mm offset	180	18	8	20	218940

363322

214968

10.1.1.8 Latch and deadbolt right-angled latch plates			L			No
silver	MF-BO right-angled latch plate without latch element 4mm air gap 10mm offset		190	32 x 25	20	363322
	MF-BO right-angled latch plate with latch element 4mm air gap 10mm offset		190	32 x 25	20	214968

210501

10.1.1.9 Latch striker plates for multi-functional latch			L	W	H		No
silver	latch striker for MF 4mm air gap 9mm offset		120	18	8	20	210501 <sup>1</sup>

<sup>1</sup> Compatible with clip-on end cap 360074 for 12mm air gap

214527

362002



10.1.1.10 Right-angled latch plates for multi-functional latch			L			No
silver	latch striker for MF with latch-receiver insert for 4 mm air gap		130	32 x 25	20	214527
	latch striker for e-opener for 4 mm air gap		130	32 x 25	20	362002

94118

10.1.1.11 Latch striker plates B-TV			L	W	H		No
silver	for 4 mm air gap adjustable		90	18	8	50	94118 <sup>1</sup>

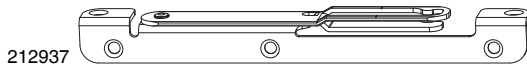
<sup>1</sup> Compatible with clip-on end cap 43718 for timber 12mm air gap



10.1.1.12 Striker plates for door turn-restrictor			L			No
silver	right	door turn-restrictor striker 4mm air gap 9mm offset	200	20 x 18	20	212936
	left	door turn-restrictor striker 4mm air gap 9mm offset	200	20 x 18	20	212937



10.1.1.13 Shootbolt striker plates for shootbolt protrusion 10 x 5 mm			L	W	H		No
silver	finger bolt striker for 4 mm air gap		120	18	8	20	26799 <sup>1</sup>
	deadbolt striker with slots for 4 mm air gap		120	18	8	20	50576

<sup>1</sup> Compatible with recess cover cap 41250



10.1.1.14 Shootbolt striker plates for shootbolt protrusion 8 x 4 mm			L	W	H		No
silver	for 4 mm air gap 2 slots		90	18	8	100	23883 <sup>1</sup>
	for 4 mm air gap 1 slot		90	18	8	100	55112 <sup>1</sup>

<sup>1</sup> Compatible with clip-on end cap 43718 for timber 12mm air gap

10.1.2 Striker plates 4 mm air gap 10 mm offset



10.1.2.1 Latch and deadbolt striker plates			L	W	H		No
silver	right	latch and deadbolt striker Z-TA 4mm air gap 10mm offset	220	20	8	20	<b>219235</b>
	left	latch and deadbolt striker Z-TA 4mm air gap 10mm offset	220	20	8	20	<b>219236</b>
		latch and deadbolt striker for 4 mm air gap	208	20	8	50	<b>29787<sup>1,2</sup></b>

<sup>1</sup> Compatible with clip-on end cap 354358 for 12mm air gap

<sup>2</sup> Compatible with recess cover cap 43524

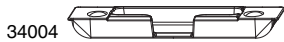

10.1.2.2 Striker plates VZ for 4 mm air gap			L	W	H		No
silver		for 4 mm air gap angled screw-fixing	90	20	8	50	<b>34004<sup>1</sup></b>

<sup>1</sup> Compatible with clip-on end cap 354358 for 12mm air gap



10.1.2.3 Striker plates i.S. for 4 mm air gap			L	W	H		No
silver	right	for 4 mm air gap angled screw-fixing	90	20	8	100	<b>96845<sup>1</sup></b>
	left	for 4 mm air gap angled screw-fixing	90	20	8	100	<b>96846<sup>1</sup></b>

<sup>1</sup> Use left-handed striker plates for right-handed doors and vice versa!



10.1.2.4 Hook and bolt striker plates			L	W	H		No
silver	right and left	hook and bolt striker for 4 mm air gap	180	20	8	20	<b>207861<sup>1,2</sup></b>

<sup>1</sup> Compatible with recess cover cap 358024

<sup>2</sup> Compatible with clip-on end cap 354358 for 12mm air gap



10.1.2.5 Latch and deadbolt striker plates			L			No	
latch and bolt striker right 4mm air gap 10mm offset silver			right	180	8 x 20	20	<b>218943</b>
latch and bolt striker left 4mm air gap 10mm offset silver			left	180	8 x 20	20	<b>218944</b>

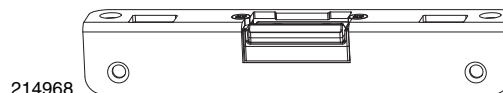
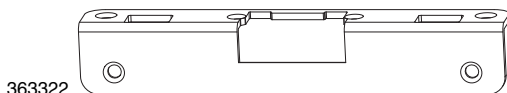

10.1.2.6 Right-angled latch plates for latch-bolt			L			No
MF-BO right-angled latch plate without latch element 4mm air gap 10mm offset silver			190	32 x 25	20	<b>363322</b>
MF-BO right-angled latch plate with latch element 4mm air gap 10mm offset silver			190	32 x 25	20	<b>214968</b>

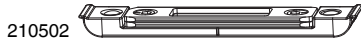

10.1.2.7 Latch striker plates for multi-functional latch		L	W	H		No
silver	latch striker for 4 mm air gap	120	20	8	20	210502 <sup>1</sup>

<sup>1</sup> Compatible with clip-on end cap 354358 for 12mm air gap

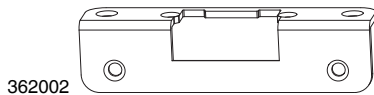

10.1.2.8 Right-angled latch plates for multi-functional latch		L			No
latch striker for e-opener for 4 mm air gap silver		130	32 x 25	20	362002

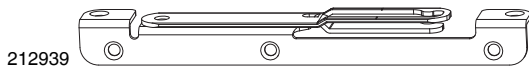

10.1.2.9 Striker plates for door turn-restrictor		L			No	
door turn-restrictor striker right 4mm air gap 10mm offset silver		right	200	20 x 20	20	212938
door turn-restrictor striker left 4mm air gap 10mm offset silver		left	200	20 x 20	20	212939



10.1.2.10 Shootbolt striker plates for shootbolt protrusion 10 x 5 mm		L			No
Finger Bolt Striker for 4mm air gap		120	20	20	29788 <sup>1,2</sup>

<sup>1</sup> Compatible with recess cover cap 41250

<sup>2</sup> Compatible with clip-on end cap 354358 for 12mm air gap

10.1.3 Striker plates 4 mm air gap 13 mm offset

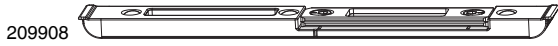

10.1.3.1 Latch and deadbolt striker plates			L	W	H		No
silver	right	latch and deadbolt striker for 4 mm air gap, 13 mm offset	208	22	8	50	209907
	left	latch and deadbolt striker for 4 mm air gap, 13 mm offset	208	22	8	50	209908

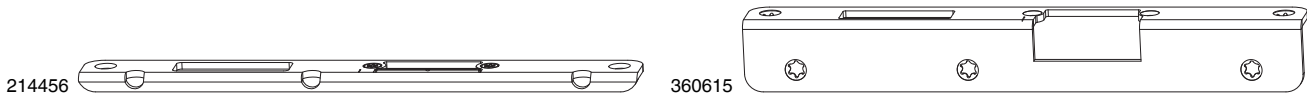

10.1.3.2 Latch and deadbolt right-angled latch plates			L			No	
right-angled latch plate for latch and deadbolt striker Z-TA right 4mm air gap 13mm offset silver			right	250	8 x 30	20	226810 <sup>1</sup>
right-angled latch plate for latch and deadbolt striker Z-TA left 4mm air gap 13mm offset silver			left	250	8 x 30	5	226811 <sup>1</sup>
latch and deadbolt right-angled latch plate right 4mm air gap 13mm offset silver			right	250	8 x 24	20	214455 <sup>2,3</sup>
latch and deadbolt right-angled latch plate left 4mm air gap 13mm offset silver			left	250	8 x 24	20	214456 <sup>2,3</sup>
right-angled latch plate for latch and deadbolt striker Z-TA right for timber silver			right	250	8 x 24	20	218901 <sup>2,3</sup>
latch and deadbolt angled striker plate for electric opener right 4mm air gap 13mm offset silver			right	250	32 x 25	20	360614
right-angled latch plate for latch and deadbolt striker Z-TA left for timber silver			left	250	8 x 24	20	218902 <sup>2,3</sup>
latch and deadbolt angled striker plate for electric opener left 4mm air gap 13mm offset silver			left	250	32 x 25	20	360615

<sup>1</sup> Compatible with clip-on end cap 369691 for 12 mm air gap.

<sup>2</sup> Compatible with clip-on end cap 362920 for 12mm air gap.

<sup>3</sup> Compatible with recess cover cap 360397

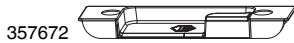

10.1.3.3 Striker plates VZ for 4 mm air gap			L	W	H		No
silver	right	for 4 mm air gap, 13 mm offset - 1 mm gasket-compression	90	22	8	200	357671
	left	for 4 mm air gap, 13 mm offset - 1 mm gasket-compression	90	22	8	200	357672

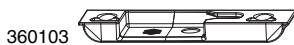

10.1.3.4 Striker plates i.S. for 4 mm air gap			L	W	H		No
silver	right	for 4 mm air gap, 13 mm offset angled screw-fixing	90	22	8	100	357673 <sup>1</sup>
		for 4 mm air gap, 13 mm offset angled screw-fixing - 1 mm gasket-compression	90	22	8	100	360102 <sup>1,2</sup>
	left	for 4 mm air gap, 13 mm offset angled screw-fixing	90	22	8	100	357674 <sup>1</sup>
		for 4 mm air gap, 13 mm offset angled screw-fixing - 1 mm gasket-compression	90	22	8	100	360103 <sup>1,2</sup>

<sup>1</sup> Use left-handed striker plates for right-handed doors and vice versa!

<sup>2</sup> Not compliant with EN 1627



10.1.3.5 Hook and bolt striker plates			L	W	H		No
silver	hook and bolt striker 4mm air gap 13mm offset		180	22	8	20	209909 <sup>1</sup>

<sup>1</sup> Compatible with recess cover cap 358024

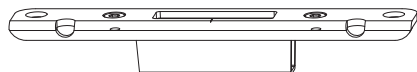

214459

**10.1.3.6 Hook and bolt right-angled latch plates**

	L	a	b		N <sup>o</sup>
MF-HO striker 4mm air gap 13mm offset silver	180	8 x 30	5		227065 <sup>1</sup>
hook and bolt striker 4mm air gap 13mm offset silver	180	8 x 24	20		214459 <sup>2</sup>

<sup>1</sup> Compatible with clip-on end cap 369691 for 12 mm air gap.

<sup>2</sup> Compatible with clip-on end cap 362920 for 12mm air gap.



214457

**10.1.3.7 Latch and deadbolt right-angled latch plates**

	L	a	b		N <sup>o</sup>
MF-BO right-angled latch plate with latch element 4mm air gap 13mm offset silver	250	8 x 24	20		214457 <sup>1,2,3</sup>

<sup>1</sup> Compatible with clip-on end cap 362920 for 12mm air gap.

<sup>2</sup> Compatible with recess cover cap 363959

<sup>3</sup> Compatible with recess cover cap 364326



211597

**10.1.3.8 Latch striker plates for multi-functional latch**

	L	W	H		N <sup>o</sup>
silver latch striker 4mm air gap 13mm offset	180	22	8	20	211597



214458

**10.1.3.9 Right-angled latch plates for multi-functional latch**

	L	a	b		N <sup>o</sup>
right-angled latch plate for MF 4mm air gap 13mm offset silver	130	8 x 24	20		214458 <sup>1</sup>

<sup>1</sup> Compatible with clip-on end cap 362920 for 12mm air gap.

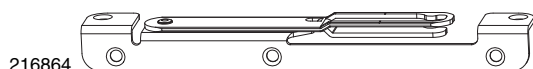

216864

**10.1.3.10 Striker plates for door turn-restrictor**

	L	a	b		N <sup>o</sup>
door turn-restrictor striker right 4mm air gap 13mm offset silver	right	200	20 x 24	20	216863
door turn-restrictor striker left 4mm air gap 13mm offset silver	left	200	20 x 24	20	216864



209911



209912

**10.1.3.11 Shootbolt striker plates for shootbolt protrusion 10 x 5 mm**

	L	W	H		N <sup>o</sup>
silver finger bolt striker 4mm air gap 13mm offset	180	22	8	20	209911
deadbolt striker with slots 4mm air gap 13mm offset	180	22	8	20	209912



209338



**10.1.3.12 Shootbolt striker plates for shootbolt protrusion 8 x 4 mm**

	L	W	H		N <sup>o</sup>
silver for 4 mm air gap, 13 mm offset 2 slots	90	22	9	100	209338

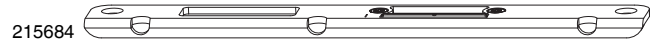
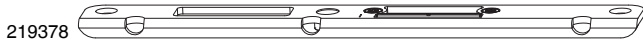
### 10.1.4 Striker plates 4 mm air gap 15 mm offset



#### 10.1.4.1 Latch and deadbolt right-angled latch plates

		L			No
right-angled latch plate for latch and deadbolt striker Z-TA right 4mm air gap 15mm offset silver	right	250	8 x 26	20	<b>219376<sup>1</sup></b>
right-angled latch plate for latch and deadbolt striker Z-TA left 4mm air gap 15mm offset silver	left	250	8 x 26	20	<b>219378<sup>1</sup></b>
right-angled latch plate for latch and deadbolt striker with receiver insert right for timber silver	right	250	8 x 26	20	<b>215683<sup>1</sup></b>
right-angled latch plate for latch and deadbolt striker with receiver insert left for timber silver	left	250	8 x 26	20	<b>215684<sup>1</sup></b>

<sup>1</sup> Compatible with recess cover cap 360397

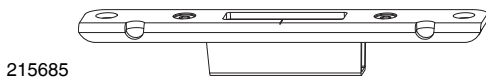

#### 10.1.4.2 Hook and bolt right-angled latch plates

		L			No
hook and bolt striker 4mm air gap 15mm offset silver		180	8 x 26	20	<b>215685</b>

### 10.1.5 Striker plates 12 mm air gap 9 mm offset

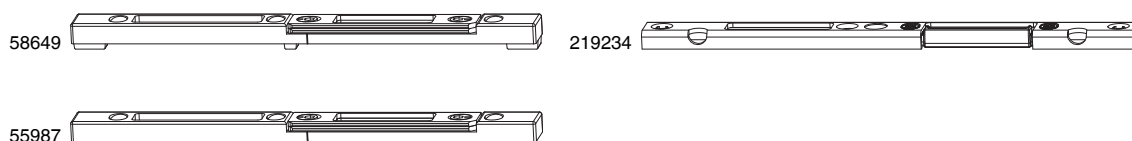

10.1.5.1 Latch and deadbolt striker plates			L	W	H		No
silver	right	latch and deadbolt striker for hardware groove 6/8/4	208	18	9	50	<b>58646<sup>1</sup></b>
		latch and deadbolt striker for hardware groove 7/8/4	208	18	9	20	<b>58648<sup>1</sup></b>
		latch and deadbolt striker Z-TA 12mm air gap 9mm offset	220	18	8	20	<b>219233</b>
left		latch and deadbolt striker for hardware groove 6/8/4	208	18	9	50	<b>58647<sup>1</sup></b>
		latch and deadbolt striker for hardware groove 7/8/4	208	18	9	20	<b>58649<sup>1</sup></b>
		latch and deadbolt striker Z-TA 12mm air gap 9mm offset	220	18	8	20	<b>219234</b>
		latch and deadbolt striker Euro-rebate	208	18	9	50	<b>55987<sup>1</sup></b>

<sup>1</sup> Compatible with recess cover cap 43524

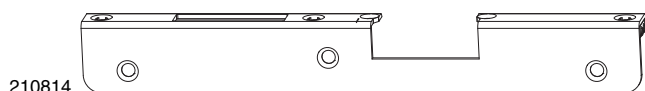

10.1.5.2 Latch and deadbolt right-angled latch plates			L			No
silver	right	right-angled latch plate for latch and deadbolt striker with receiver insert Euro-rebate 18 mm	250	32 x 18	20	<b>210809</b>
		latch and deadbolt angled striker plate for electric opener Euro-rebate 18 mm	250	32 x 18	20	<b>210813</b>
left		right-angled latch plate for latch and deadbolt striker with receiver insert Euro-rebate 18 mm	250	32 x 18	20	<b>210810</b>
		latch and deadbolt angled striker plate for electric opener Euro-rebate 18 mm	250	32 x 18	20	<b>210814</b>



10.1.5.3 Striker plates VZ			L	W	H		No
silver	Euro-rebate 18 mm double screw fixing		49	17	9	200	<b>34943</b>
	for hardware groove 7/8/4 - 1 mm gasket-compression		48	16	8	200	<b>34969</b>
	for hardware groove 6/8/4 - 1 mm gasket-compression		48	16	8	200	<b>34979</b>
	Euro-rebate 18 mm angled screw-fixing		48	17	9	200	<b>34980</b>



10.1.5.4 Striker plates i.S.			L	W	H		No
silver	Euro-rebate 18 mm angled screw-fixing - 0.7 mm gasket-compression		68	18	9	100	<b>96660</b>
	for hardware groove 6/8/4 - 1 mm gasket-compression		68	18	9	100	<b>96263</b>
	for hardware groove 7/8/4 angled screw-fixing - 1 mm gasket-compression		68	18	9	100	<b>96264</b>



10.1.5.5 Hook and bolt striker plates			L	W	H		No
silver	hook and bolt striker for 4 mm air gap		180	18	8	20	<b>207862<sup>1,2</sup></b>

<sup>1</sup> Must be used in combination with clip-on end cap 43718!

<sup>2</sup> Compatible with recess cover cap 358024



10.1.5.6 Latch and deadbolt striker plates			L	W		N <sup>o</sup>
silver	right	latch and bolt striker 12mm air gap 9mm offset	180	18	20	218941
	left	latch and bolt striker 12mm air gap 9mm offset	180	18	20	218942

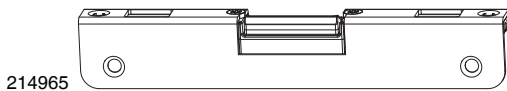

10.1.5.7 Latch and bolt right-angled latch plates			L			N <sup>o</sup>
silver	MF-BO right-angled latch plate with latch element 12mm air gap 9mm offset		190	32 x 18	20	214965

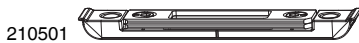

10.1.5.8 Latch striker plates for multi-functional latch			L	W	H		N <sup>o</sup>
silver	latch striker for MF 4mm air gap 9mm offset		120	18	8	20	210501 <sup>1</sup>

<sup>1</sup> Must be used with clip-on end cap 360074!



10.1.5.9 Right-angled latch plates for multi-functional latch			L			N <sup>o</sup>
silver	Right-angled latch plate for MF or latch element Euro-rebate 18 mm		130	32 x 18	20	213325
	right-angled latch plate for MF Euro-rebate 18 mm		130	32 x 18	20	214504



10.1.5.10 Latch striker plates B-TV			L	W	H		N <sup>o</sup>
silver	Euro-rebate 18 mm adjustable		80	17	6,5	50	38924
	for hardware groove 7/8/4 adjustable		80	17	6,5	50	55252
	for hardware groove 6/8/4 adjustable		80	17	6,5	50	94322

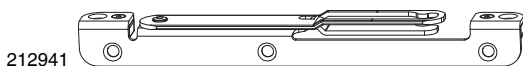

10.1.5.11 Striker plates for door turn-restrictor			L			N <sup>o</sup>
silver	right	door turn-restrictor striker 12mm air gap 9mm offset	200	20 x 18	20	212940
	left	door turn-restrictor striker 12mm air gap 9mm offset	200	20 x 18	20	212941



10.1.5.12 Shootbolt striker plates for shootbolt protrusion 10 x 5 mm			L	W	H		N <sup>o</sup>
silver	deadbolt striker with slots Euro-rebate		120	18	8	20	55986
	deadbolt striker with slots for hardware groove 7/8/4		120	18	8	20	50579
	finger bolt striker for hardware groove 7/8/4		84	18	8	20	26617
	finger bolt striker Euro-rebate		84	18	8	20	58667



10.1.5.13 Shootbolt striker plates for shootbolt protrusion 8 x 4 mm		L	W	H		N <sup>o</sup>
silver	Euro-rebate 18 mm 2 slots H = 6.5 mm	80	17	6,5	100	<b>23731</b>
	hardware groove 2 slots	80	17	6,5	100	<b>23886</b>
	Euro-rebate 18 mm 2 slots H = 7.5 mm	80	17	7,5	100	<b>26755</b>

**10.1.6 Striker plates 12 mm air gap 10 mm offset**



10.1.6.1 Latch and deadbolt striker plates			L	W	H		N <sup>o</sup>
silver	right	latch and deadbolt striker Z-TA 12mm air gap 10mm offset	220	20	8	20	<b>219237</b>
	left	latch and deadbolt striker Z-TA 12mm air gap 10mm offset	220	20	8	20	<b>219238</b>
		latch and deadbolt striker for 4 mm air gap	208	20	8	50	<b>29787<sup>1,2</sup></b>

<sup>1</sup> Must be used with clip-on end cap 354358!

<sup>2</sup> Compatible with recess cover cap 43524

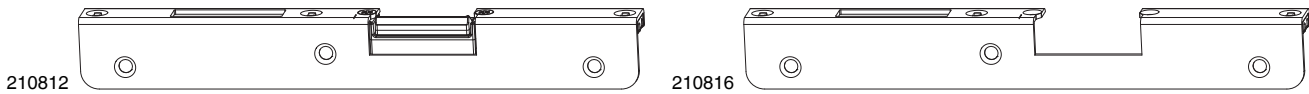

10.1.6.2 Latch and deadbolt right-angled latch plates			L			N <sup>o</sup>
silver	right	right-angled latch plate for latch and deadbolt striker with receiver insert Euro-rebate 20 mm	250	32 x 20	20	<b>210811</b>
		latch and deadbolt angled striker plate for electric opener Euro-rebate 20 mm	250	32 x 20	20	<b>210815</b>
	left	right-angled latch plate for latch and deadbolt striker with receiver insert Euro-rebate 20 mm	250	32 x 20	20	<b>210812</b>
		latch and deadbolt angled striker plate for electric opener Euro-rebate 20 mm	250	32 x 20	20	<b>210816</b>



10.1.6.3 Striker plates VZ			L	W	H		N <sup>o</sup>
silver		Euro-rebate 20 mm angled screw-fixing	48	19	9	200	<b>34981</b>

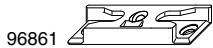

10.1.6.4 Striker plates i.S.			L	W	H		N <sup>o</sup>
silver		Euro-rebate 20 mm angled screw-fixing - 0.7 mm gasket-compression	68	20	9	100	<b>96861</b>
		Euro-rebate 20 mm angled screw-fixing	68	20	9	100	<b>96561</b>

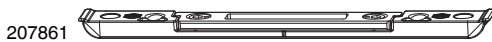

10.1.6.5 Hook and bolt striker plates			L	W	H		N <sup>o</sup>
silver	right and left	hook and bolt striker for 4 mm air gap	180	20	8	20	<b>207861<sup>1,2</sup></b>

<sup>1</sup> Must be used with clip-on end cap 354358!

<sup>2</sup> Compatible with recess cover cap 358024

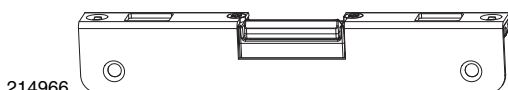

10.1.6.6 Latch and bolt right-angled latch plates			L			N <sup>o</sup>
silver		MF-BO right-angled latch plate with latch element 12mm air gap 10mm offset	190	32 x 20	20	<b>214966</b>

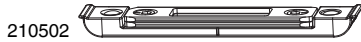

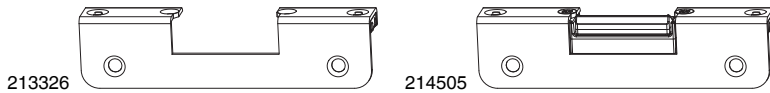

10.1.6.7 Latch striker plates for multi-functional latch			L	W	H		No
silver	latch striker for 4 mm air gap		120	20	8	20	210502 <sup>1</sup>

<sup>1</sup> Must be used with clip-on end cap 354358!

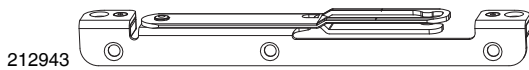

10.1.6.8 Right-angled latch plates for multi-functional latch			L			No
silver	latch striker for MF for electric opener Euro-rebate 20 mm		130	32 x 20	20	213326
	latch striker for MF with latch-receiver insert Euro-rebate 20 mm		130	32 x 20	20	214505



10.1.6.9 Striker plates for door turn-restrictor			L			No
silver	right	door turn-restrictor striker 12mm air gap 10mm offset	200	20 x 20	20	212942
	left	door turn-restrictor striker 12mm air gap 10mm offset	200	20 x 20	20	212943

**10.1.7 Striker plates 12 mm air gap 13 mm offset**

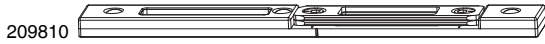

10.1.7.1 Latch and deadbolt striker plates			L	W	H		N <sup>o</sup>
silver	right	latch and deadbolt striker 24mm rebate depth, 13mm offset	208	23	9	50	<b>209809<sup>1</sup></b>
	left	latch and deadbolt striker 24mm rebate depth, 13mm offset	208	23	9	50	<b>209810<sup>1</sup></b>

<sup>1</sup> Compatible with recess cover cap 43524

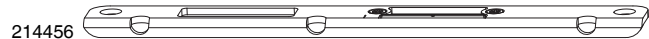
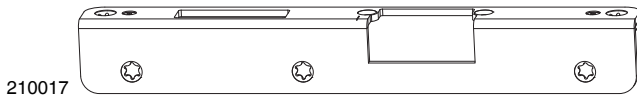

10.1.7.2 Latch and deadbolt right-angled latch plates			L			N <sup>o</sup>
silver	right	right-angled latch plate for latch and deadbolt striker Z-TA 4mm air gap 13mm offset	250	8 x 30	20	<b>226810</b>
		latch and deadbolt angled striker plate for electric opener for 12mm air gap, 13mm offset	250	33 x 24	20	<b>210016</b>
		latch and deadbolt right-angled latch plate 4mm air gap 13mm offset	250	8 x 24	20	<b>214455<sup>1,2</sup></b>
		right-angled latch plate for latch and deadbolt striker Z-TA for timber	250	8 x 24	20	<b>218901<sup>1,2</sup></b>
	left	right-angled latch plate for latch and deadbolt striker Z-TA 4mm air gap 13mm offset	250	8 x 30	5	<b>226811</b>
		latch and deadbolt angled striker plate for electric opener for 12mm air gap, 13mm offset	250	33 x 24	20	<b>210017</b>
		latch and deadbolt right-angled latch plate 4mm air gap 13mm offset	250	8 x 24	20	<b>214456<sup>1,2</sup></b>
		right-angled latch plate for latch and deadbolt striker Z-TA for timber	250	8 x 24	20	<b>218902<sup>1,2</sup></b>

<sup>1</sup> Must be used with clip-on end cap 362920!

<sup>2</sup> Compatible with recess cover cap 360397



10.1.7.3 Striker plates VZ			L	W	H		N <sup>o</sup>
silver		24mm rebate depth, 13mm offset angled screw-fixing	48	23	9	200	<b>34934</b>



10.1.7.4 Striker plates i.S.			L	W	H		N <sup>o</sup>
silver		24mm rebate depth, 13mm offset without reinforcement rings angled screw-fixing	68	23	9	100	<b>364952</b>
		24mm rebate depth, 13mm offset without reinforcement rings angled screw-fixing - 1 mm gasket-compression	68	23	9	100	<b>364953</b>



10.1.7.5 Hook and bolt striker plates			L	W	H		N <sup>o</sup>
silver		hook and bolt striker for 12mm air gap, 13mm offset	180	23	8	20	<b>210779<sup>1</sup></b>

<sup>1</sup> Compatible with recess cover cap 358024

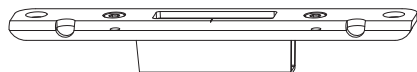

214459

**10.1.7.6 Hook and bolt right-angled latch plates**

		L	a	b		No
silver	MF-HO striker 4mm air gap 13mm offset	180	8 x 30	5		227065
	hook and bolt striker 4mm air gap 13mm offset	180	8 x 24	20		214459 <sup>1</sup>

<sup>1</sup> Must be used with clip-on end cap 362920!



214457

**10.1.7.7 Latch and deadbolt right-angled latch plates**

		L	a	b		No
silver	MF-BO right-angled latch plate with latch element 4mm air gap 13mm offset	250	8 x 24	20		214457 <sup>1,2,3</sup>

<sup>1</sup> Compatible with recess cover cap 363959

<sup>2</sup> Must be used with clip-on end cap 362920!

<sup>3</sup> Compatible with recess cover cap 364326



211598

**10.1.7.8 Latch striker plates for multi-functional latch**

		L	W	H		No
silver	latch striker for MF timber 24mm rebate depth 12mm air gap 13mm offset	180	23	8	20	211598



214458

**10.1.7.9 Right-angled latch plates for multi-functional latch**

		L	a	b		No
silver	right-angled latch plate for MF 4mm air gap 13mm offset	130	8 x 24	20		214458 <sup>1</sup>

<sup>1</sup> Compatible with clip-on end cap 362920 for 12mm air gap.



209347

**10.1.7.10 Latch striker plates B-TV**

		L	W	H		No
silver	24mm rebate depth, 13mm offset adjustable	80	23	6,5	50	209347

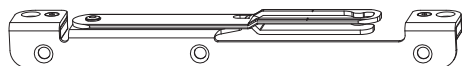

216866

**10.1.7.11 Striker plates for door turn-restrictor**

		L	a	b		No
silver	right door turn-restrictor striker 12mm air gap 13mm offset	200	20 x 24	20		216865
	left door turn-restrictor striker 12mm air gap 13mm offset	200	20 x 24	20		216866



210782



210781

**10.1.7.12 Shootbolt striker plates for shootbolt protrusion 10 x 5 mm**

		L	W	H		No
silver	deadbolt striker with slots for 12mm air gap, 13mm offset	180	23	8	20	210782
	finger bolt striker 24mm rebate depth, 13mm offset	180	23	8	20	210781

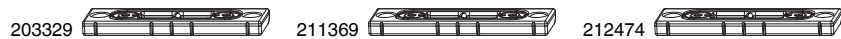

10.1.7.13 Shootbolt striker plates for shootbolt protrusion 8 x 4 mm		L	W	H		N <sup>o</sup>
silver	24mm rebate depth, 13mm offset 2 slots	80	23	6,5	100	<b>203329</b>
	24mm rebate depth, 13mm offset 2 slots with angled screw-fixing + 1 mm gasket-compression	80	23	6,5	100	<b>211369</b>
	24mm rebate depth, 13mm offset 2 slots with angled screw-fixing	80	23	7,7	100	<b>212474</b>

## 10.2 Striker plates opposite hardware groove



10.2.1 Latch and deadbolt striker plates				L	W	H		N <sup>o</sup>
silver	right	latch and deadbolt striker Z-TA for PVC		235	24	8	20	<b>226489</b>
		latch and deadbolt striker EH for electric opener for PVC		250	32	8	20	<b>209104</b>
		latch and deadbolt striker Z-TA for PVC		250	32	8	20	<b>219258</b>
	left	latch and deadbolt striker Z-TA for PVC		235	24	8	20	<b>226490</b>
		latch and deadbolt striker EH for electric opener for PVC		250	32	8	20	<b>209105</b>
		latch and deadbolt striker Z-TA for PVC		250	32	8	20	<b>219259</b>



10.2.2 Striker plates VZ				L	W	H		N <sup>o</sup>
silver	opposite Eurogroove - 1 mm gasket-compression			48	19	8	200	<b>34606</b>
	opposite Eurogroove			48	17	8	200	<b>34610</b>



10.2.3 Striker plates i.S.				L	W	H		N <sup>o</sup>
silver	right	i.S. striker plate for PVC		80	30	8	20	<b>354987</b>
	left	i.S. striker plate for PVC		80	30	8	20	<b>355000</b>
	opposite Eurogroove - 0.8 mm gasket-compression			68	20	9	100	<b>96558</b>



10.2.4 Hook and bolt striker plates				L	W	H		N <sup>o</sup>
silver	hook and bolt striker Eurogroove			180	18	8	20	<b>217676</b>
	MF-HO striker			180	32	6	20	<b>219260</b>



10.2.5 Latch and deadbolt angled striker plates				L	W	H		N <sup>o</sup>
silver	right	latch and bolt striker for PVC		220	32	7	20	<b>215425</b>
	left	latch and bolt striker for PVC		220	32	7	20	<b>215424</b>
	latch and bolt striker MD for electric opener for PVC			200	24	20	20	<b>103413</b>



10.2.6 Latch striker plates				L	W		N <sup>o</sup>
silver	latch striker MD with insert E opposite Eurogroove			120	24	20	<b>215497</b>

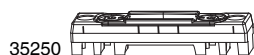



10.2.7 Latch striker plates B-TV				L	W	H		N <sup>o</sup>
silver	for Eurogroove			80	17	6,5	50	<b>35250</b>

### 10.3 Single piece door striker for timber



#### 10.3.1 Single piece door striker for timber U-6x24x6 13 mm offset

				W		L		No	
24mm rebate depth, 13mm offset	silver	right	2HO-BO	6	24	6	2.200	5	214190 <sup>1,2</sup>
			2HO-BO+ZS	6	24	6	2.200	5	216637 <sup>1,2</sup>
			2MF+2i.S.	6	24	6	2.400	5	102842 <sup>2</sup>
			2MF+2i.S. K+500	6	24	6	2.000	5	102846 <sup>2</sup>
			2MF+3i.S.	6	24	6	2.400	5	102844 <sup>2</sup>
		2MF-BO	6	24	6	2.200	5	215907 <sup>2,3</sup>	
		2MF-BO K+500	6	24	6	2.035	5	215911 <sup>2,3</sup>	
		2MF-BO K+980	6	24	6	2.200	5	215909 <sup>2,3</sup>	
		2MF-HO	6	24	6	2.200	5	218784 <sup>2,4</sup>	
		2MF-HO K+605	6	24	6	2.035	5	224649 <sup>2,4</sup>	
	2MF-HO K+980	6	24	6	2.200	5	224651 <sup>2,4</sup>		
	4HO-BO	6	24	6	2.200	5	226733 <sup>1,2</sup>		
	4i.S.	6	24	6	2.400	5	102850 <sup>2</sup>		
	left	2HO-BO	6	24	6	2.200	5	214191 <sup>1,2</sup>	
		2HO-BO+ZS	6	24	6	2.200	5	216638 <sup>1,2</sup>	
		2MF+2i.S.	6	24	6	2.400	5	102843 <sup>2</sup>	
		2MF+2i.S. K+500	6	24	6	2.000	5	102847 <sup>2</sup>	
		2MF+3i.S.	6	24	6	2.400	5	102845 <sup>2</sup>	
		2MF-BO	6	24	6	2.200	5	215908 <sup>2,3</sup>	
		2MF-BO K+500	6	24	6	2.035	5	215912 <sup>2,3</sup>	
2MF-BO K+980		6	24	6	2.200	5	215910 <sup>2,3</sup>		
2MF-HO		6	24	6	2.200	5	218785 <sup>2,4</sup>		
2MF-HO K+605		6	24	6	2.035	5	224650 <sup>2,4</sup>		
2MF-HO K+980	6	24	6	2.200	5	224652 <sup>2,4</sup>			
4HO-BO	6	24	6	2.200	5	226734 <sup>1,2</sup>			
4i.S.	6	24	6	2.400	5	102851 <sup>2</sup>			

<sup>1</sup> To use with door lock Z-TS

<sup>2</sup> Compatible with screw cover cap 362704

<sup>3</sup> To use with door lock Z-TF

<sup>4</sup> To use with door lock Z-TA



**10.3.2 Single piece door striker for timber U-8x28x8 13 mm offset**



									No
28 mm rebate depth, 13 mm offset	silver	right	2HO-BO	8	28	8	2.220	5	102937 <sup>1</sup>
			2HO-BO+TB	8	28	8	2.220	5	103372 <sup>1</sup>
			2MF+2i.S.	8	28	8	2.220	5	102964
			2MF+3i.S.	8	28	8	2.320	5	102966
			2MF-BO	8	28	8	2.220	5	102933 <sup>2</sup>
			2MF-BO K+500	8	28	8	2.150	5	103571 <sup>2</sup>
			2MF-BO K+980	8	28	8	2.320	5	102935 <sup>2</sup>
			2MF-HO	8	28	8	2.220	5	104110 <sup>3</sup>
			2MF-HO K+605	8	28	8	2.150	5	104106 <sup>3</sup>
			2MF-HO K+980	8	28	8	2.420	5	104108 <sup>3</sup>
			4HO-BO	8	28	8	2.220	5	102939 <sup>1</sup>
			left	2HO-BO	8	28	8	2.220	5
		2HO-BO+TB	8	28	8	2.220	5	103373 <sup>1</sup>	
		2MF+2i.S.	8	28	8	2.220	5	102965	
		2MF+3i.S.	8	28	8	2.320	5	102967	
		2MF-BO	8	28	8	2.220	5	102934 <sup>2</sup>	
		2MF-BO K+500	8	28	8	2.150	5	103572 <sup>2</sup>	
		2MF-BO K+980	8	28	8	2.320	5	102936 <sup>2</sup>	
		2MF-HO	8	28	8	2.220	5	104111 <sup>3</sup>	
		2MF-HO K+605	8	28	8	2.150	5	104107 <sup>3</sup>	
		2MF-HO K+980	8	28	8	2.420	5	104109 <sup>3</sup>	
		4HO-BO	8	28	8	2.220	5	102940 <sup>1</sup>	

<sup>1</sup> To use with door lock Z-TS

<sup>2</sup> To use with door lock Z-TF

<sup>3</sup> To use with door lock Z-TA



**10.3.3 Single piece door striker for timber U-8x28x12 13 mm offset**



									No
28 mm rebate depth, 13 mm offset	silver	right	2HO-BO	8	28	12	2.220	5	102984 <sup>1</sup>
			2MF+2i.S.	8	28	12	2.220	5	102994
			2MF+3i.S.	8	28	12	2.320	5	102996
			2MF-BO	8	28	12	2.220	5	102990 <sup>2</sup>
			2MF-BO K+980	8	28	12	2.320	5	102992 <sup>2</sup>
			4HO-BO	8	28	12	2.220	5	102986 <sup>1</sup>
			left	2HO-BO	8	28	12	2.220	5
		2MF+2i.S.	8	28	12	2.220	5	102995	
		2MF+3i.S.	8	28	12	2.320	5	102997	
		2MF-BO	8	28	12	2.220	5	102991 <sup>2</sup>	
		2MF-BO K+980	8	28	12	2.320	5	102993 <sup>2</sup>	
		4HO-BO	8	28	12	2.220	5	102987 <sup>1</sup>	

<sup>1</sup> To use with door lock Z-TS

<sup>2</sup> To use with door lock Z-TF



**10.3.4 Single piece door striker for timber U-10x30x10 15 mm offset**



W



L



No

Material	Color	Hand	Model	10	W	2	L	No	Product No
timber 30mm rebate depth 15mm offset	silver	right	2HO-BO	10	30	10	2.400	5	215715 <sup>1</sup>
			2HO-BO K+980	10	30	10	2.400	5	215719 <sup>1</sup>
			2HO-BO+TB	10	30	10	2.400	5	215721 <sup>1</sup>
			2HO_BO K+605	10	30	10	2.400	5	215717 <sup>1</sup>
			2MF-BO	10	30	10	2.400	5	217036
			2MF-BO K+500	10	30	10	2.400	5	217038
			2MF-BO K+980	10	30	10	2.400	5	217040 <sup>2</sup>
			2MF-HO	10	30	10	2.400	5	219527 <sup>3</sup>
			2MF-HO K+605	10	30	10	2.400	5	219529 <sup>3</sup>
		2MF-HO K+980	10	30	10	2.400	5	219531 <sup>3</sup>	
		left	4HO-BO	10	30	10	2.400	5	216690 <sup>1</sup>
			2HO-BO	10	30	10	2.400	5	215716 <sup>1</sup>
			2HO-BO K+980	10	30	10	2.400	5	215720 <sup>1</sup>
			2HO_BO K+605	10	30	10	2.400	5	215718 <sup>1</sup>
			2MF-BO	10	30	10	2.400	5	217037 <sup>2</sup>
			2MF-BO K+500	10	30	10	2.400	5	217039 <sup>2</sup>
			2MF-BO K+980	10	30	10	2.400	5	217041 <sup>2</sup>
			2MF-HO	10	30	10	2.400	5	219528 <sup>3</sup>
			2MF-HO K+605	10	30	10	2.400	5	219530 <sup>3</sup>
2MF-HO K+980	10		30	10	2.400	5	219532 <sup>3</sup>		
4HO-BO	10	30	10	2.400	5	216691 <sup>1</sup>			

<sup>1</sup> To use with door lock Z-TS

<sup>2</sup> To use with door lock Z-TF

<sup>3</sup> To use with door lock Z-TA









## 10.5 Striker plates ALU

### 10.5.1 Striker plates ALU 3 mm

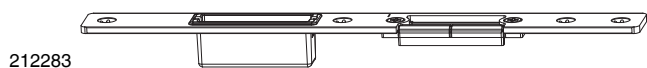

212283

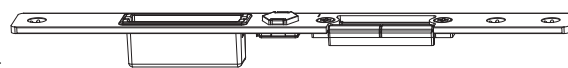

219184

#### 10.5.1.1 Latch and deadbolt striker plates

			L	W	H		No
silver	right	latch and deadbolt striker for alu	250	24	3	20	<b>212282</b>
		latch and deadbolt striker Z-TA for alu	250	24	3	20	<b>219183</b>
	left	latch and deadbolt striker for alu	250	24	3	20	<b>212283</b>
		latch and deadbolt striker Z-TA for alu	250	24	3	20	<b>219184</b>

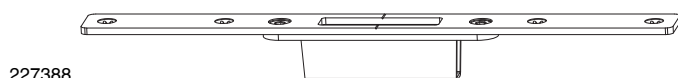

227388

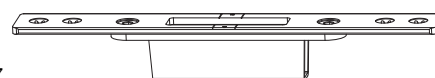

212647

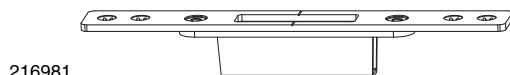

216981

#### 10.5.1.2 Hook- and bolt striker plates

			L	W	H		No
silver	hook and bolt striker for alu		265	24	3	20	<b>227388</b>
			190	25	3	20	<b>212647</b>
				24	3	20	<b>216981</b>



216977

#### 10.5.1.3 Latch and deadbolt striker plates

			L	W	H		No
silver	latch and bolt striker for alu		200	24	3	20	<b>216977</b>



214407

### 10.5.2 Alu 3 mm locking bar for 14 mm frame groove

			L	W	H		No
silver	right	latch and deadbolt striker for aluminium 14 mm frame groove	270	24	3	20	<b>214407</b>
		latch and deadbolt striker Z-TA for aluminium 14 mm frame groove	270	24	3	20	<b>219036</b>
	left	latch and deadbolt striker for aluminium 14 mm frame groove	270	24	3	20	<b>214408</b>
		latch and deadbolt striker Z-TA for aluminium 14 mm frame groove	270	24	3	20	<b>219037</b>
		hook and bolt striker for aluminium 14 mm frame groove	190	25	3	20	<b>214409</b>

### 10.5.3 Single piece door striker ALU 6 mm

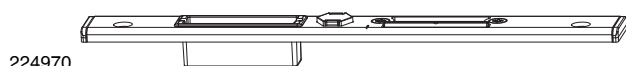

224970

#### 10.5.3.1 Latch and deadbolt striker plates

			L	W	H		No
silver	right	latch and deadbolt striker for PVC	235	24	6	20	<b>213237</b>
		latch and deadbolt striker EH for electric opener for PVC	235	24	6	20	<b>213240</b>
		latch and deadbolt striker Z-TA for alu	240	24	6	20	<b>224969</b>
	left	latch and deadbolt striker for PVC	235	24	6	20	<b>213239</b>
		latch and deadbolt striker EH for electric opener for PVC	235	24	6	20	<b>213241</b>
		latch and deadbolt striker Z-TA for alu	240	24	6	20	<b>224970</b>

213180 

10.5.3.2 Hook- and bolt striker plates			L	W	H		No
silver	hook and bolt striker for alu		160	24	6	20	<b>213180<sup>1</sup></b>

<sup>1</sup> Compatible with recess cover cap 358027

102998 

10.5.3.3 Latch and deadbolt striker plates			L	W		No
silver	latch and bolt striker for alu		200	24	20	<b>102998</b>

216755 

10.5.3.4 Striker plates for door turn-restrictor			W	L		No
silver	right	door turn-restrictor striker for alu	24	220	20	<b>216754</b>
	left	door turn-restrictor striker for alu	24	220	20	<b>216755</b>

## 10.6 Single piece door striker for PVC

215233 

219040 

219042 

219038 



### 10.6.1 Single piece door striker ALU 3 mm

			L	W	H		No
silver	right	single piece door striker for alu	1.942	24	3	5	<b>215235</b>
			1.567	24	3	5	<b>215233</b>
			1.692	24	3	5	<b>215231</b>
			1.555	24	3	5	<b>215227</b>
			1.680	24	3	5	<b>214466</b>
			1.930	24	3	5	<b>215229</b>
			1.555	24	3	5	<b>219040</b>
	left	single piece door striker for alu	1.930	24	3	5	<b>219042</b>
			1.680	24	3	5	<b>219038</b>
			1.942	24	3	5	<b>215236</b>
			1.555	24	3	5	<b>215228</b>
			1.692	24	3	5	<b>215232</b>
			1.680	24	3	5	<b>214467</b>
			1.567	24	3	5	<b>215234</b>
			1.930	24	3	5	<b>215230</b>
			1.555	24	3	5	<b>219041</b>
			1.930	24	3	5	<b>219043</b>
			1.680	24	3	5	<b>219039</b>

224971 

208470 

### 10.6.2 Single piece door striker ALU 6 mm

			 1	W	 2	L		No	
silver	right	2MF-HO	6	24	6	1.855	5	<b>224971</b>	
		2MF-HO K+605	6	24	6	1.725	5	<b>224973</b>	
		2MF-HO K+980	6	24	6	2.105	5	<b>224975</b>	
		4HO-BO	6	24	6	1.850	5	<b>208470</b>	
	left		2MF-HO	6	24	6	1.855	5	<b>224972</b>
			2MF-HO K+605	6	24	6	1.725	5	<b>224974</b>
			2MF-HO K+980	6	24	6	2.105	5	<b>224976</b>
			4HO-BO	6	24	6	1.850	5	<b>208471</b>



## 11 French casement drive gear







---

<b>11.1</b>	<b>French casement drive gear</b>	<b>182</b>
11.1.1	French casement drive gears for timber 13 mm offset 24 mm rebate depth U-8x24x8	182
11.1.2	French casement drive gears for timber 13 mm offset 28 mm rebate depth U-8x24x8	182
11.1.3	French casement drive gears 13 mm offset U-8x28x12 opposite Eurogroove	183
11.1.4	French casement drive gear 4i.S. HH1050 F-16	183
11.1.5	French casement drive gear 4i.S. HH1050 F-16 without locking bolt	183
11.1.6	Serrated carrier connector with faceplate restrainers	183
<b>11.2</b>	<b>End pieces for french casement drive gears</b>	<b>184</b>
11.2.1	End pieces for timber 13 mm offset 24 mm rebate depth U-8x24x8	184
11.2.2	End pieces for timber 13 mm offset 28 mm rebate depth U-8x28x8	184
11.2.3	End pieces 13mm offset U-8x28x8 opposite Eurogroove	184
11.2.4	End pieces for timber 24 mm rebate depth with integrated MF-HO/HO-BO striker plate U-8x24x8	184
11.2.5	End pieces for timber 28 mm rebate depth with integrated MF-HO/HO-BO striker plate U-8x28x8	185
11.2.6	End pieces with integrated MF-HO/HO-BO striker plate U-8x28x8 for opposite Eurogroove	185
11.2.7	Shootbolt end piece for french casement drive gear	185
<b>11.3</b>	<b>Extensions for French casement drive gears</b>	<b>186</b>
11.3.1	Extensions 13 mm offset with integrated MF-HO/HO-BO striker plates U-8x24x8	186
11.3.2	Extensions 13 mm offset with integrated MF-HO/HO-BO striker plates U-8x28x8	186
11.3.3	Extensions 13 mm offset U-8x28x8 opposite Eurogroove	186

## 11 French casement drive gear

### 11.1 French casement drive gear







219798

11.1.1 French casement drive gears for timber 13 mm offset 24 mm rebate depth U-8x24x8							L			No
silver	right	2MF-BO	1.050	8	24	8	2.255	340	5	219423 <sup>1</sup>
		2MF-BO K+500	1.050	8	24	8	2.130	340	5	219425 <sup>1</sup>
		2MF-BO K+980	1.050	8	24	8	2.400	185	5	219427 <sup>1</sup>
		2MF-HO	1.050	8	24	8	2.255	340	5	219798 <sup>2</sup>
		2MF-HO K+605	1.050	8	24	8	2.130	340	5	219800 <sup>2</sup>
		2MF-HO K+980	1.050	8	24	8	2.400	185	5	219802 <sup>2</sup>
	left	2MF-BO	1.050	8	24	8	2.255	340	5	219424 <sup>1</sup>
		2MF-BO K+500	1.050	8	24	8	2.130	340	5	219426 <sup>1</sup>
		2MF-BO K+980	1.050	8	24	8	2.400	185	5	219428 <sup>1</sup>
		2MF-HO	1.050	8	24	8	2.255	340	5	219799 <sup>2</sup>
		2MF-HO K+605	1.050	8	24	8	2.130	340	5	219801 <sup>2</sup>
		2MF-HO K+980	1.050	8	24	8	2.400	185	5	219803 <sup>2</sup>

<sup>1</sup> To use with door lock Z-TF

<sup>2</sup> To use with door lock Z-TA

219032







11.1.2 French casement drive gears for timber 13 mm offset 28 mm rebate depth U-8x24x8							L			No
silver	right	2MF+2i.S.	1.050	8	28	8	2.255	340	5	212413
		2MF+3i.S.	1.050	8	28	8	2.400	185	5	212415
		2MF-BO	1.050	8	28	8	2.255	340	5	214208 <sup>1</sup>
		2MF-BO K+500	1.050	8	28	8	2.130	340	5	217144 <sup>1</sup>
		2MF-BO K+980	1.050	8	28	8	2.400	185	5	214210 <sup>1</sup>
		2MF-HO	1.050	8	28	8	2.255	340	5	219032 <sup>2</sup>
		2MF-HO K+605	1.050	8	28	8	2.130	340	5	219591 <sup>2</sup>
		2MF-HO K+980	1.050	8	28	8	2.400	185	5	219593 <sup>2</sup>
		4HO-BO	1.050	8	28	8	2.255	340	5	212411 <sup>3</sup>
		left	2MF+2i.S.	1.050	8	28	8	2.255	340	5
	2MF+3i.S.		1.050	8	28	8	2.400	185	5	212416
	2MF-BO		1.050	8	28	8	2.255	340	5	214209 <sup>1</sup>
	2MF-BO K+500		1.050	8	28	8	2.130	340	5	217145 <sup>1</sup>
	2MF-BO K+980		1.050	8	28	8	2.400	185	5	214211 <sup>1</sup>
	2MF-HO		1.050	8	28	8	2.255	340	5	219033 <sup>2</sup>
	2MF-HO K+605		1.050	8	28	8	2.130	340	5	219592 <sup>2</sup>
	2MF-HO K+980		1.050	8	28	8	2.400	185	5	219594 <sup>2</sup>
	4HO-BO		1.050	8	28	8	2.255	340	5	212412 <sup>3</sup>

<sup>1</sup> To use with door lock Z-TF

<sup>2</sup> To use with door lock Z-TA

<sup>3</sup> To use with door lock Z-TS

219030 





<b>11.1.3 French casement drive gears 13 mm offset U-8x28x12 opposite Eurogroove</b>							<b>L</b>			<b>No</b>
silver	right	2MF-BO	1.050	8	28	8	2.255	340	5	<b>214216<sup>1</sup></b>
		2MF-BO K+500	1.050	8	28	8	2.130	340	5	<b>217154<sup>1</sup></b>
		2MF-BO K+980	1.050	8	28	8	2.400	185	5	<b>214218<sup>1</sup></b>
		2MF-HO	1.050	8	28	8	2.255	340	5	<b>219030<sup>2</sup></b>
		2MF-HO K+605	1.050	8	28	8	2.130	340	5	<b>219586<sup>2</sup></b>
		2MF-HO K+980	1.050	8	28	8	2.400	185	5	<b>219589<sup>2</sup></b>
	left	4HO-BO	1.050	8	28	8	2.255	340	5	<b>213117<sup>3</sup></b>
		2MF-BO	1.050	8	28	8	2.255	340	5	<b>214217<sup>1</sup></b>
		2MF-BO K+500	1.050	8	28	8	2.130	340	5	<b>217155<sup>1</sup></b>
		2MF-BO K+980	1.050	8	28	8	2.400	185	5	<b>214219<sup>1</sup></b>
		2MF-HO	1.050	8	28	8	2.255	340	5	<b>219031<sup>2</sup></b>
		2MF-HO K+605	1.050	8	28	8	2.130	340	5	<b>219588<sup>2</sup></b>
		2MF-HO K+980	1.050	8	28	8	2.400	185	5	<b>219590<sup>2</sup></b>
		4HO-BO	1.050	8	28	8	2.255	340	5	<b>213118<sup>3</sup></b>

<sup>1</sup> To use with door lock Z-TF



<sup>2</sup> To use with door lock Z-TA

<sup>3</sup> To use with door lock Z-TS

227136 

<b>11.1.4 French casement drive gear 4i.S. HH1050 F-16</b>					<b>L</b>			<b>No</b>
silver	right	4i.S.	1.050	16	2.150	287	5	<b>227136</b>
	left	4i.S.	1.050	16	2.150	287	5	<b>227137</b>

206454 

<b>11.1.5 French casement drive gear 4i.S. HH1050 F-16 without locking bolt</b>				<b>L</b>			<b>No</b>
silver			1.050	1.860	264	10	<b>206454</b>





10792 

<b>11.1.6 Serrated carrier connector with faceplate restrainers</b>				<b>No</b>
toothed bar connector with faceplate restrainer, silver			50	<b>10792</b>

## 11.2 End pieces for french casement drive gears

219444  219445 



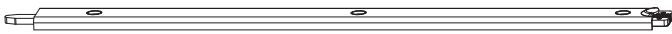

### 11.2.1 End pieces for timber 13 mm offset 24 mm rebate depth U-8x24x8

						L		No
silver	left/right	12mm air gap 13mm offset	8	24	8	125	10	<b>219444</b>
						260	5	<b>219445</b>
						415	5	<b>219446</b>

215858  212419 

212421 





### 11.2.2 End pieces for timber 13 mm offset 28 mm rebate depth U-8x28x8

						L		No
silver	right	for timber 12mm air gap	8	28	8	125	5	<b>215858</b>
	left	for timber 12mm air gap	8	28	8	125	10	<b>215859</b>
	right	for timber 12mm air gap	8	28	8	260	5	<b>212419</b>
	left	for timber 12mm air gap	8	28	8	260	5	<b>212420</b>
	right	for timber 12mm air gap	8	28	8	415	5	<b>212421</b>
	left	for timber 12mm air gap	8	28	8	415	5	<b>212422</b>

215862  213621 

213623 





### 11.2.3 End pieces 13mm offset U-8x28x8 opposite Eurogroove

						L		No
silver	right	for Eurogroove	8	28	8	125	10	<b>215862</b>
	left	for Eurogroove	8	28	8	125	5	<b>215863</b>
	right	for Eurogroove	8	28	8	260	5	<b>213621</b>
	left	for Eurogroove	8	28	8	260	5	<b>213622</b>
	right	for Eurogroove	8	28	8	415	5	<b>213623</b>
	left	for Eurogroove	8	28	8	415	5	<b>213624</b>

219438 

219440 

### 11.2.4 End pieces for timber 24 mm rebate depth with integrated MF-HO/HO-BO striker plate U-8x24x8

						L		No
silver	right	12mm air gap 13mm offset	8	24	8	355	5	<b>219438</b>
	left	12mm air gap 13mm offset	8	24	8	355	5	<b>219439</b>
	right	12mm air gap 13mm offset	8	24	8	565	5	<b>219440</b>
	left	12mm air gap 13mm offset	8	24	8	565	5	<b>219441</b>

216254

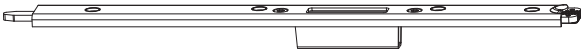

216256

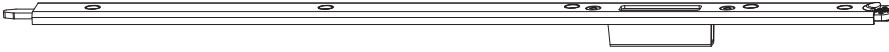

**11.2.5 End pieces for timber 28 mm rebate depth with integrated MF-HO/HO-BO striker plate U-8x28x8**



**No**

silver	right	8	28	8	355	5	<b>216254</b>
	left	8	28	8	355	5	<b>216255</b>
	right	8	28	8	565	5	<b>216256</b>
	left	8	28	8	565	5	<b>216257</b>

216294

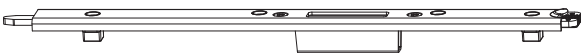

216296

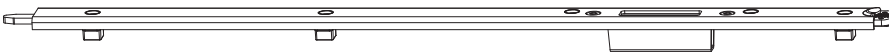

**11.2.6 End pieces with integrated MF-HO/HO-BO striker plate U-8x28x8 for opposite Eurogroove**



**No**

silver	right	opposite Eurogroove	8	28	8	355	5	<b>216294</b>
	left	opposite Eurogroove	8	28	8	355	5	<b>216295</b>
	right	opposite Eurogroove	8	28	8	565	5	<b>216296</b>
	left	opposite Eurogroove	8	28	8	565	5	<b>216297</b>

55049



**11.2.7 Shootbolt end piece for french casement drive gear**



**No**

silver			16	170	20	<b>55049</b>
--------	--	--	----	-----	----	--------------

### 11.3 Extensions for French casement drive gears



219442

#### 11.3.1 Extensions 13 mm offset with integrated MF-HO/HO-BO striker plates U-8x24x8



L



No

silver	right	12mm air gap 13mm offset	8	24	8	590	5	<b>219442</b>
	left	12mm air gap 13mm offset	8	24	8	590	5	<b>219443</b>



216258

#### 11.3.2 Extensions 13 mm offset with integrated MF-HO/HO-BO striker plates U-8x28x8



L



No

silver	right	timber 12 mm air gap 28 mm rebate depth	8	28	8	590	5	<b>216258</b>
	left	timber 12 mm air gap 28 mm rebate depth	8	28	8	590	5	<b>216259</b>

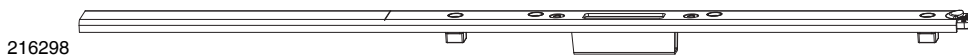

216298

#### 11.3.3 Extensions 13 mm offset U-8x28x8 opposite Eurogroove



L



No

silver	right	opposite Eurogroove	8	28	8	590	5	<b>216298</b>
	left	opposite Eurogroove	8	28	8	590	5	<b>216299</b>



## 12 Shootbolts

---





<b>12.1</b>	<b>Finger operated door shootbolts</b>	<b>188</b>
12.1.1	Finger operated door shootbolts	188
12.1.2	Finger operated door shootbolts 12 mm air gap	188
12.1.3	Finger operated door shootbolts for Eurogroove	189
12.1.4	Finger operated door shootbolts for PVC	189
<b>12.2</b>	<b>Finger operated slave door shootbolts</b>	<b>190</b>
12.2.1	Finger operated slave door shootbolts 4 mm air gap	190

## 12 Shootbolts

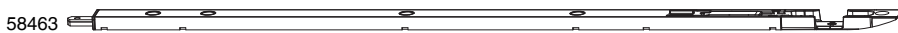
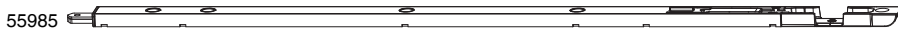
### 12.1 Finger operated door shootbolts

#### 12.1.1 Finger operated door shootbolts







12.1.1.1 Finger operated door shootbolts 4 mm air gap 9 mm offset						L		No
silver	4mm air gap		R8	11	8	255	20	<b>58464</b>
						540	20	<b>58468</b>
				18	8	255	20	<b>208998</b>
						540	20	<b>208999</b>
					10	540	20	<b>55985</b>
						255	20	<b>55989</b>
		bottom left	R8	18	7	255	20	<b>59424</b>
		bottom right	R8	18	7	255	20	<b>59425</b>
			R90	18	8	540	20	<b>58463</b>
						255	20	<b>58467</b>
					10	255	20	<b>59422</b>
						540	20	<b>59423</b>

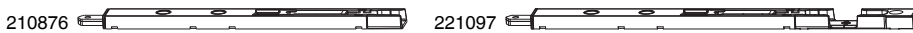

12.1.1.2 Finger operated door shootbolts 4 mm air gap 13 mm offset U-6x24x6						L		No
silver	for 4 mm air gap, 13 mm offset	left		20	10	120	20	<b>213834</b>
		right		20	10	120	20	<b>213833</b>

#### 12.1.2 Finger operated door shootbolts 12 mm air gap



12.1.2.1 Finger operated door shootbolts 12 mm air gap 9 mm offset						L		No
silver	4mm air gap		R8	11	8	255	20	<b>58464<sup>1</sup></b>
						540	20	<b>58468<sup>1</sup></b>
				18	8	255	20	<b>208998<sup>1</sup></b>
						540	20	<b>208999<sup>1</sup></b>
					10	540	20	<b>55985<sup>1</sup></b>
						255	20	<b>55989<sup>1</sup></b>
		Euro-rebate		18	10	200	20	<b>210876</b>
						255	20	<b>221097</b>

<sup>1</sup> Must be used in combination with clip-on end cap 43718!

58608

59427

12.1.2.2 Finger operated door shootbolts 12 mm air gap hardware groove 6/8/4					L		No
silver	Hardware groove 6/8/4	left	11	8	255	20	<b>58609</b>
		right	11	8	540	20	<b>59426</b>
		left			255	20	<b>58608</b>
		right			540	20	<b>59427</b>

59429 58574

12.1.2.3 Finger operated door shootbolts 12 mm air gap hardware groove 7/8/4					L		No
silver	hardware groove 7/8/4	left	11	8	255	20	<b>59428</b>
		right	11	8	540	20	<b>59430</b>
		left			255	20	<b>59429</b>
		right			540	20	<b>59431</b>
		left	18	10	255	20	<b>58575</b>
		right	18	10	255	20	<b>58574</b>

213831

12.1.2.4 Finger operated door shootbolts 12 mm air gap 13 mm offset U-6x24x6					L		No
silver	for 12mm air gap, 13mm offset	right	20	10	120	20	<b>213831</b>
		left	20	10	120	20	<b>213832</b>

### 12.1.3 Finger operated door shootbolts for Eurogroove

213829

12.1.3.1 Finger operated door shootbolts U-6x24x6					L		No
silver	for Eurogroove MD	left	20	10	120	20	<b>213830</b>
		right	20	10	120	20	<b>213829</b>

213825

12.1.3.2 Finger operated door shootbolts U-6x32x6					L		No
silver	for Eurogroove	right	20	10	130	20	<b>213825</b>
		left	20	10	130	20	<b>213826</b>





208998

12.1.4 Finger operated door shootbolts for PVC					L		No
silver	4mm air gap	R8	11	8	255	20	<b>58464<sup>1</sup></b>
				8	540	20	<b>58468<sup>1</sup></b>
			18	8	255	20	<b>208998<sup>1</sup></b>
				8	540	20	<b>208999<sup>1</sup></b>
				10	540	20	<b>55985<sup>1</sup></b>
				255	20	<b>55989<sup>1</sup></b>	

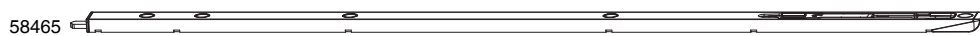
<sup>1</sup> Must be used together with packer for shootbolt.

## 12.2 Finger operated slave door shootbolts



12.2.1 Finger operated slave door shootbolts 4 mm air gap					L		No
silver	4mm air gap	R8	12	8	600	20	<b>58465</b>
					540	20	<b>209000</b>
					255	20	<b>57915</b>
					425	20	<b>57916</b>
		R90	12	8	540	20	<b>59433</b>
					255	20	<b>58029</b>
					425	20	<b>58030</b>
					600	20	<b>58469</b>



**13 openLife**

---

<b>13.1</b>	<b>Profile cylinder</b>	<b>192</b>
<b>13.2</b>	<b>Half cylinder</b>	<b>193</b>
<b>13.3</b>	<b>Push furniture</b>	<b>194</b>
<b>13.4</b>	<b>Accessories</b>	<b>196</b>

## 13 openLife

473411

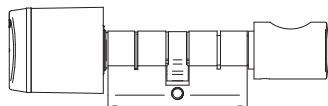

### 13.1 Profile cylinder



**No**

MACO openLife profile cylinder

Silber

30/30	1	<b>473411</b>
30/40	1	<b>473412</b>
35/25	1	<b>473413</b>
35/30	1	<b>473414</b>
35/35	1	<b>473415</b>
40/30	1	<b>473416</b>
40/35	1	<b>473838</b>
40/40	1	<b>473417</b>
45/30	1	<b>473418</b>
45/45	1	<b>473419</b>
45/50	1	<b>473837</b>
50/30	1	<b>473420</b>
50/40	1	<b>473421</b>
50/45	1	<b>473422</b>
50/50	1	<b>473423</b>
60/50	1	<b>476049</b>
65/50	1	<b>476047</b>
65/70	1	<b>476048</b>
75/40	1	<b>473905</b>
75/45	1	<b>473839</b>
80/40	1	<b>476050</b>
85/50	1	<b>473906</b>
30/30	1	<b>473923</b>
30/40	1	<b>473924</b>
30/45	1	<b>476036</b>
35/25	1	<b>473925</b>
35/30	1	<b>473926</b>
35/35	1	<b>473927</b>
40/30	1	<b>473928</b>
40/35	1	<b>473929</b>
40/40	1	<b>473930</b>
45/30	1	<b>473931</b>
45/45	1	<b>473932</b>
45/50	1	<b>473933</b>
45/60	1	<b>473941</b>
50/30	1	<b>473934</b>
50/40	1	<b>473935</b>
50/45	1	<b>473936</b>
50/50	1	<b>473937</b>
50/60	1	<b>473942</b>
75/40	1	<b>473938</b>
75/45	1	<b>473939</b>
85/50	1	<b>473940</b>

SKG

Silber

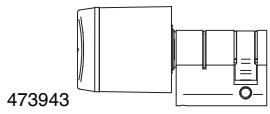

473943

**13.2 Half Cylinder**



**No**

MACO openLife half cylinder	SKG	Silber	40/10	1	<b>473943</b>
			45/10	1	<b>473944</b>

### 13.3 Push furniture

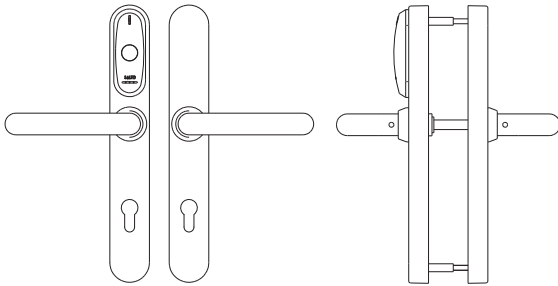

473907

13.3.1 Push furniture E85							No
silver	Profile Thickness 45-60mm	85	40	8	anodised	1	473907
	Profile Thickness 60-75mm	85	40	8	anodised	1	473908
	Profile Thickness 75-90mm	85	40	8	anodised	1	473909

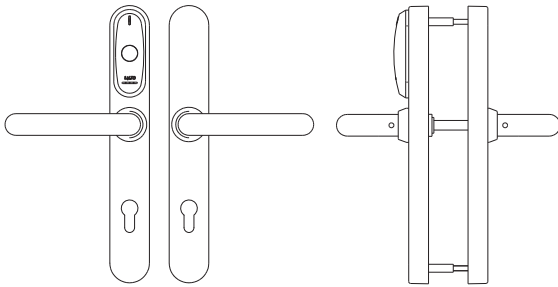

473606

13.3.2 Push furniture E92							No	
silver	Profile Thickness 45-60mm	92	40	8	anodised	1	473606	
	Profile Thickness 60-75mm	92	40	8	anodised	1	473607	
	Profile Thickness 75-90mm	92	40	8	anodised	1	473608	
	SKG**	Profile Thickness 45-60mm	92	40	8	anodised	1	473948
		Profile Thickness 60-75mm	92	40	8	anodised	1	473949
		Profile Thickness 75-90mm	92	40	8	anodised	1	473950

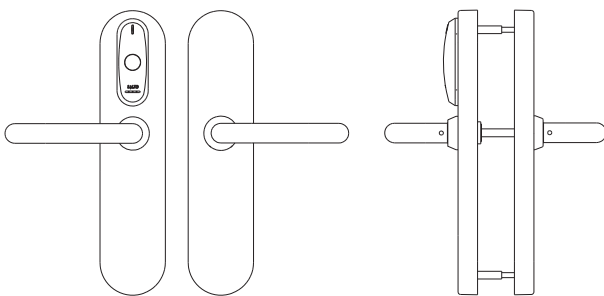

473609

13.3.3 Handle furniture E92 with wide plate							No
silver	Profile Thickness 75-90mm	0	67	8	anodised	1	473609
		92	67	8	anodised	1	473610

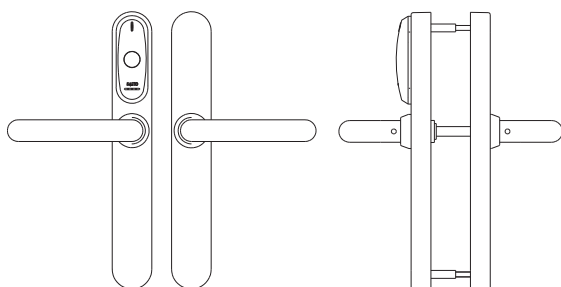

473398

13.3.4 Push furniture E92 without PC							No
silver		Profile Thickness 45-60mm	40	8	anodised	1	<b>473398</b>
		Profile Thickness 60-75mm	40	8	anodised	1	<b>473399</b>
		Profile Thickness 75-90mm	40	8	anodised	1	<b>473400</b>
SKG**		Profile Thickness 45-60mm	40	8	anodised	1	<b>473945</b>
		Profile Thickness 60-75mm	40	8	anodised	1	<b>473946</b>
		Profile Thickness 75-90mm	40	8	anodised	1	<b>473947</b>

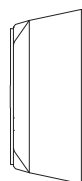

473424

### 13.4 Accessories



**No**

MACO openLife control unit white	1	<b>473426</b>
MACO openLife cylinder guage	1	<b>473915</b>
MACO openLife installation wrench for cylinder	1	<b>473910</b>
MACO openLife IQ white	1	<b>473424</b>
MACO openLife power adapters AU	1	<b>476045</b>
MACO openLife power adapters UK	1	<b>476044</b>
MACO openLife RF tester silver	1	<b>473840</b>
MACO openLife sample case	1	<b>473611</b>
MACO openLife signal amplifier white	1	<b>473425</b>
MACO openLife Transponder-Tag	5	<b>473428</b>
MACO openLife wall reader black	1	<b>473605</b>
MACO openLife wall reader white	1	<b>473427</b>



## 14 Accessories





<b>14.1</b>	<b>End pieces for door lock Z-TS and G-TS</b>	<b>198</b>
14.1.1	Inline end pieces	198
14.1.2	Reverse-action end pieces	200
<b>14.2</b>	<b>End pieces for door lock C-TS</b>	<b>202</b>
14.2.1	Inline end pieces	202
14.2.2	Reverse-action end pieces	202
<b>14.3</b>	<b>Accessories for door lock Z-TA</b>	<b>203</b>
14.3.1	Extension faceplates	203
14.3.2	Shortening faceplates	203
14.3.3	Intermediate faceplates	203
14.3.4	Motor for Z-TA Comfort	203
14.3.5	Access control systems	203
14.3.6	Cables and accessories for profiles with 4 mm and 12 mm air gap	204
14.3.7	Test magnet for Z-TA	204
14.3.8	Power supplies — transformers	205
<b>14.4</b>	<b>Accessories for modular locks</b>	<b>206</b>
14.4.1	Faceplate extension	206
14.4.2	Shortening faceplate	206
14.4.3	Connector faceplate	206
14.4.4	Faceplate module with magnetic cam	207
14.4.5	Faceplate module HO-BO	207
14.4.6	Faceplate module additional lock	207
14.4.7	Faceplate module for door restrictor	208
<b>14.5</b>	<b>Accessories for B-TV MULTI TREND</b>	<b>209</b>
14.5.1	End pieces top with i.S. without shootbolt protrusion	209
14.5.2	End pieces top with VZ without shootbolt protrusion	209
14.5.3	End pieces top with i.S. and shootbolt protrusion	209
14.5.4	End pieces top without cam with shootbolt protrusion	209
14.5.5	End pieces top with i.S. and shootbolt protrusion	209
14.5.6	End pieces bottom with i.S. without shootbolt protrusion	209
14.5.7	End pieces bottom with VZ without shootbolt protrusion	209
<b>14.6</b>	<b>Accessories for B-TV MULTI MATIC</b>	<b>210</b>
14.6.1	Faceplate extension B-TV	210
14.6.2	Corner element B-TV	210
14.6.3	End pieces bottom without cam with shootbolt protrusion	210
<b>14.7</b>	<b>Roller latch for Z-TS PT-M</b>	<b>211</b>
<b>14.8</b>	<b>Offset latch for Z-TS PT-M</b>	<b>211</b>
<b>14.9</b>	<b>Offset latch for Z-TF PT-M</b>	<b>211</b>
<b>14.10</b>	<b>Packer for shootbolt</b>	<b>211</b>
<b>14.11</b>	<b>Recess cover cap</b>	<b>211</b>
<b>14.12</b>	<b>Recess cover caps</b>	<b>212</b>
<b>14.13</b>	<b>Cover caps</b>	<b>212</b>
<b>14.14</b>	<b>Faceplate strip covers</b>	<b>212</b>
<b>14.15</b>	<b>Drill-in bushes for shootbolt</b>	<b>212</b>
<b>14.16</b>	<b>Universal access key</b>	<b>212</b>
<b>14.17</b>	<b>Turn-only hinge safety device</b>	<b>212</b>
<b>14.18</b>	<b>Latch clips</b>	<b>213</b>
<b>14.19</b>	<b>Latch elements</b>	<b>213</b>

## 14 Accessories

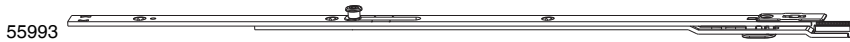
### 14.1 End pieces for door lock Z-TS and G-TS

#### 14.1.1 Inline end pieces



14.1.1.1 End pieces without shootbolt protrusion						L		No
silver	1.900 - 2.100	16	255	1	300	10	<b>57824</b>	
		20	255	1	300	10	<b>11243</b>	
		24	255	1	300	10	<b>101506</b>	
		24/16	255	1	300	10	<b>212767</b>	
	2.100 - 2.300	16	255	1	500	10	<b>55993</b>	
		20	255	1	500	10	<b>11244</b>	
		24	255	1	500	10	<b>101507</b>	
		24/16	540	1	500	10	<b>215167</b>	
	2.185 - 2.385	16	540	1	585	10	<b>57825</b>	
		20	540	1	585	10	<b>101489</b>	
		24	540	1	585	10	<b>101508</b>	
		24/16	540	1	585	10	<b>215172</b>	
2.300 - 2.500	16	255	1	700	10	<b>57826</b>		
	20	255	1	700	10	<b>101490</b>		
	24	255	1	700	10	<b>101509</b>		
	24/16	255	1	700	10	<b>215169</b>		
2.385 - 2.585	16	540	1	785	10	<b>57827</b>		
	20	540	1	785	10	<b>101491</b>		
	24	540	1	785	10	<b>101510</b>		
	24/16	540	1	785	10	<b>215175</b>		

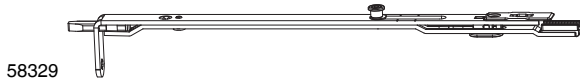



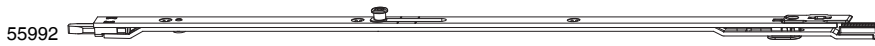



14.1.1.2 End pieces with shootbolt protrusion and lateral fixing tab							L		No
silver	1.900 - 2.100	16	255	9	1	0	300	10	<b>58329</b>
							300	10	<b>58331</b>
		20	255	9	1	0	300	10	<b>201160</b>
									<b>201162</b>
		24	255	9	1	0	300	10	<b>101492</b>
									<b>101493</b>
	2.100 - 2.300	16	255	9	1	0	500	10	<b>58330</b>
									<b>59405</b>
		20	255	9	1	0	500	10	<b>201161</b>
									<b>201163</b>

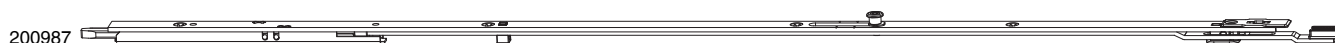
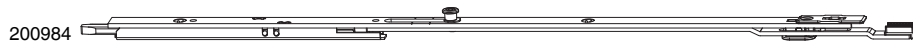

14.1.1.3 End pieces with shootbolt protrusion without lateral fixing tab							L		No							
silver	1.900 - 2.100	16	255	9	1	0	300	10	<b>58107</b>							
							300	10	<b>101483</b>							
		20	255	9	1	0	300	10	<b>101500</b>							
									<b>215154</b>							
	2.100 - 2.300	16	255	9	1	0	500	10	<b>55992</b>							
									2.185 - 2.385	16	540	9	1	585	10	<b>58458</b>
																2.385 - 2.585

### 14.1.2 Reverse-action end pieces



14.1.2.1 Reverse-action end piece with shootbolt protrusion							<b>L</b>		<b>No</b>
silver	1.900 - 2.100	16	255	9	1	300	10	<b>200983</b>	
		20	255		1	300	10	<b>101484</b>	
		24	255	9	1	300	10	<b>101501</b>	
		24 /16	255	9	1	300	5	<b>215160</b>	
	2.100 - 2.300	16	255	9	1	500	10	<b>200984</b>	
		20	255		1	500	10	<b>101485</b>	
		24	255	9	1	500	10	<b>101502</b>	
		24 /16	255	9	1	500	5	<b>215164</b>	
	2.185 - 2.385	16	540	9	1	585	10	<b>200985</b>	
		20	540	9	1	585	10	<b>101486</b>	
		24	540	9	1	585	10	<b>101503</b>	
		24 /16	540	9	1	585	5	<b>215173</b>	
	2.300 - 2.500	16	255	9	1	700	10	<b>200986</b>	
		20	255	9	1	700	10	<b>101487</b>	
		24	255	9	1	700	10	<b>101504</b>	
		24 /16	255		1	700	5	<b>215170</b>	
	2.385 - 2.585	16	540	9	1	785	10	<b>200987</b>	
		20	540	9	1	785	10	<b>101488</b>	
		24	540	9	1	785	10	<b>101505</b>	
		24 /16	540	9	1	785	5	<b>215176</b>	

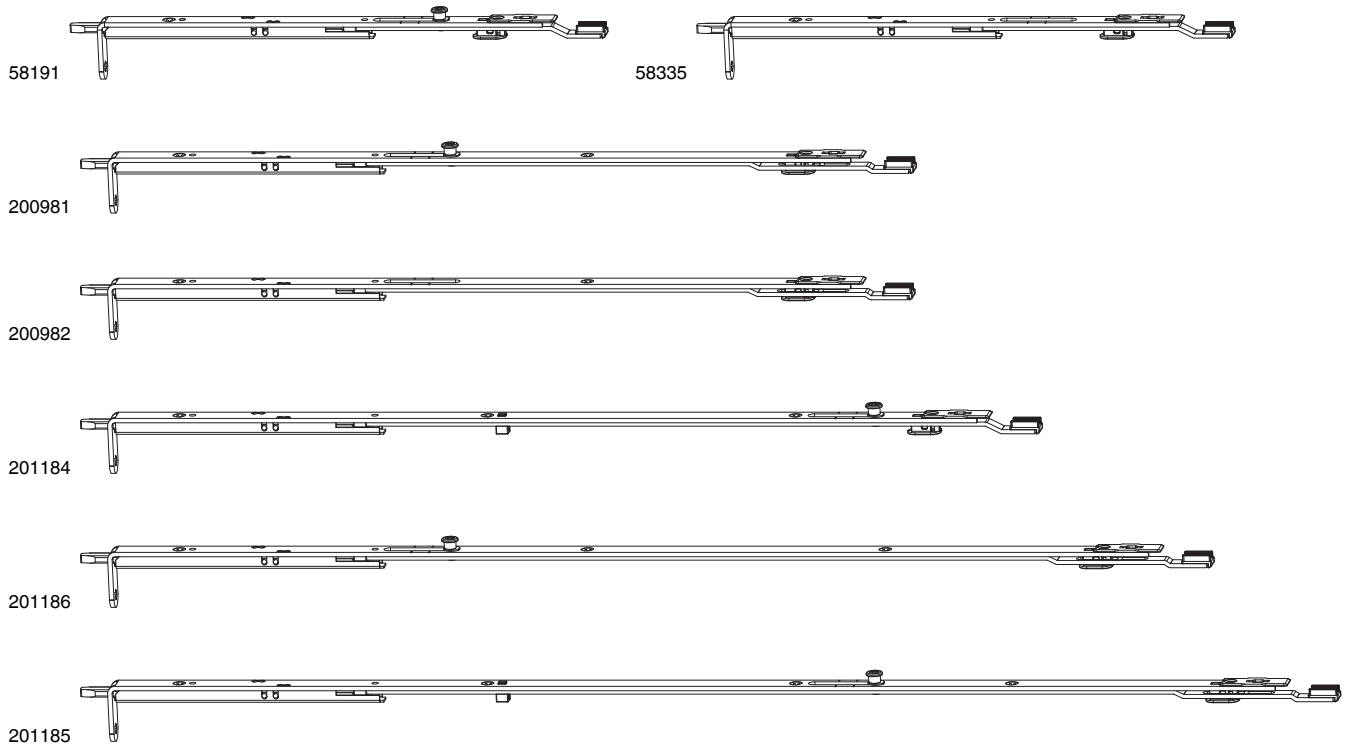

14.1.2.2 Reverse-action end piece with shootbolt protrusion and lateral fixing tab							<b>L</b>		<b>No</b>
silver	1.900 - 2.100	16	255	9	0	300	10	<b>58191</b>	
					1	300	10	<b>58335</b>	
		20	255	9	0	300	10	<b>101072</b>	
	2.100 - 2.300	24	255	9	1	300	10	<b>101073</b>	
					0	300	10	<b>101494</b>	
					0	300	10	<b>101499</b>	
	2.185 - 2.385	16	540	9	1	500	10	<b>200981</b>	
					0	500	10	<b>200982</b>	
		20	255	1	500	10	<b>101479</b>		
	2.300 - 2.500	24	255	9	1	500	10	<b>101495</b>	
		16	540	9	1	585	10	<b>201184</b>	
		20	540	9	1	585	10	<b>101480</b>	
	2.385 - 2.585	24	540	9	1	585	10	<b>101496</b>	
		16	255	9	1	700	10	<b>201186</b>	
		20	255	9	1	700	10	<b>101481</b>	
	24	255	9	1	700	10	<b>101497</b>		
	16	540	9	1	785	10	<b>201185</b>		
	20	540	9	1	785	10	<b>101482</b>		
			24	540	9	1	785	10	<b>101498</b>





## 14.2 End pieces for door lock C-TS

### 14.2.1 Inline end pieces



227601





#### 14.2.1.1 Inline end pieces with shootbolt protrusion, lateral fixing tab and i.S.

					L		No
silver	1.520 - 2.200	20	255	9	120	10	<b>227601</b>



227597

#### 14.2.1.2 Inline end pieces with shootbolt protrusion and lateral fixing tab without i.S.





					L		No
silver	1.900 - 2.100	20	255	9	120	10	<b>227597</b>
	1.750 - 1.900	16	255	9	120	20	<b>209355</b>
	1.900 - 2.100	16	255	9	120	10	<b>211831</b>

### 14.2.2 Reverse-action end pieces



227602



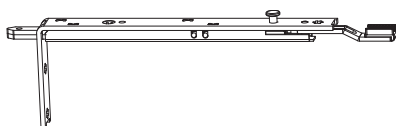

#### 14.2.2.1 Reverse-action end pieces with shootbolt protrusion, lateral fixing tab and i.S.

					L		No
silver	1.900 - 2.100	20	255	9	200	10	<b>227602</b>
		16	255	9	200	10	<b>101959</b>
						10	<b>102363</b>
	20	255	9	300	10	<b>101073</b>	
	16	255	9	300	10	<b>58335</b>	
2.100 - 2.300	16	255	9	500	10	<b>200982</b>	



227598





#### 14.2.2.2 Reverse-action end pieces with shootbolt protrusion and lateral fixing tab without i.S.

					L		No
silver	1.900 - 2.100	20	255	9	200	10	<b>227598</b>
					300	10	<b>227599</b>
	16	255	9	300	10	<b>211835</b>	
	2.100 - 2.300	20	255	9	500	10	<b>227600</b>
	16	255	9	500	10	<b>211836</b>	



104902

#### 14.2.2.3 End pieces with lateral fixing tab and i.S.

					L		No
silver	2.100 - 2.300	20	255	9	500	10	<b>104902</b>

### 14.3 Accessories for door lock Z-TA



14.3.1 Extension faceplates			L		N <sup>o</sup>
Extension faceplate Z-TA silver	F	16	250	10	<b>104785</b>
		20	250	10	<b>104786</b>
		24	250	10	<b>104787</b>
		24 /16	250	10	<b>104788</b>
	U	24	250	10	<b>104789</b>

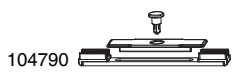

14.3.2 Shortening faceplates			L		N <sup>o</sup>
Shortening faceplate Z-TA silver	F	16	50	10	<b>104790</b>
		20	50	10	<b>104791</b>
		24	50	10	<b>104792</b>
		24 /16	50	10	<b>104793</b>
	U	24	50	10	<b>104794</b>

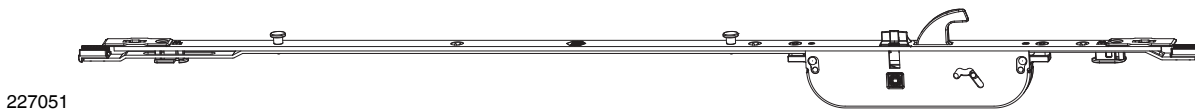

14.3.3 Intermediate faceplates			L		N <sup>o</sup>
intermediate faceplate with 1 MF-HO silver	F	16	705	5	<b>227051</b>
		20	705	5	<b>227052</b>
		24	705	5	<b>227053</b>
		24 /16	705	5	<b>227054</b>
	U	24	705	5	<b>227055</b>

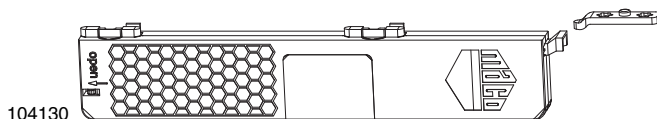

14.3.4 Motor for Z-TA Comfort			N <sup>o</sup>
motor for Z-TA Comfort		1	<b>104130</b>

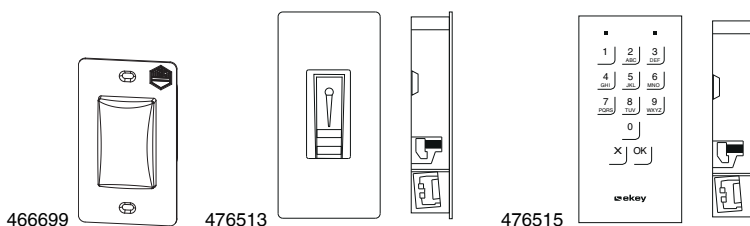

14.3.5 Access control systems		N <sup>o</sup>
OpenDoor Transponder Plus E	1	<b>466699</b>
OpenDoor Touchkey	1	<b>476513</b>
OpenDoor Touchkey BT	1	<b>476514</b>
OpenDoor Keypad	1	<b>476515</b>



466842

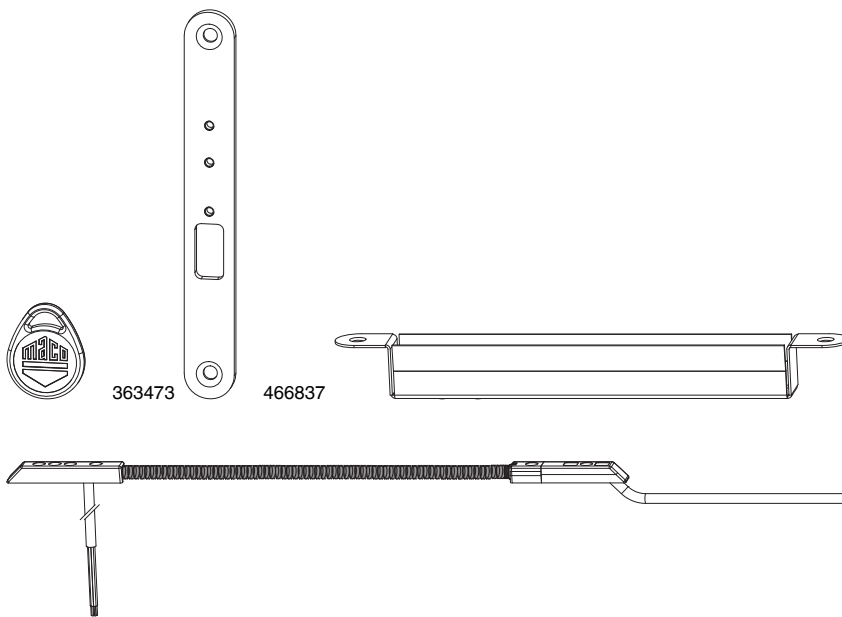

458274

363473

466837

466833

**14.3.6 Cables and accessories for profiles with 4 mm and 12 mm air gap**



**No**

OpenDoor tester	1	466842
Transponder 125 kHz for openDoor	1	458274
cable 10 m	1	466835
cable junction cover plate, timber stainless steel	1	363473
cable tray for 4 mm air gap	1	466837
clip-on cable transition 2.5 / 10m	1	466834
clip-on cable transition 2.5 / 6m	1	466833
cover for cable transition F-20	1	466838
pigtail cable 150mm	1	466836

227538



**14.3.7 Test magnet for Z-TA**



**No**

test magnet Z-TA	20	227538
------------------	----	--------



367702

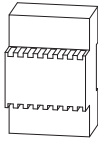

367701

**14.3.8 Power supplies — transformers**





**No**

Power supply flush-mounted	1	<b>367702</b>
Power supply top hat track	1	<b>367701</b>

## 14.4 Accessories for modular locks



102219 

### 14.4.1 Faceplate extension

			L		No
extension faceplate silver	F	16	250	10	<b>102219</b>
		20	250	10	<b>102555</b>
		24	250	10	<b>102745</b>
		24/16	250	10	<b>102929</b>
	U	24	250	10	<b>103059</b>

102556 

### 14.4.2 Shortening faceplate

			L		No
shortening faceplate silver	F	16	50	10	<b>102556</b>
		20	50	10	<b>102557</b>
		24	50	10	<b>103062</b>
		24/16	50	10	<b>102930</b>
	U	24	50	10	<b>103058</b>

215098





215102





212643





### 14.4.3 Connector faceplate

			L		No
connector with BO silver	F	16	705	5	<b>215098</b>
				5	<b>215102</b>
		20	705	5	<b>215099</b>
				5	<b>215103</b>
		24	705	5	<b>215100</b>
	5			<b>215104</b>	
	24/16	705	5	<b>215101</b>	
			5	<b>215105</b>	
	U	24	705	5	<b>215396</b>
				5	<b>215395</b>
connector with HO-BO silver	F	16	705	5	<b>212643</b>
				5	<b>212758</b>
	20	705	705	5	<b>212762</b>
				5	<b>213961</b>
	U	24	705	5	<b>215376</b>

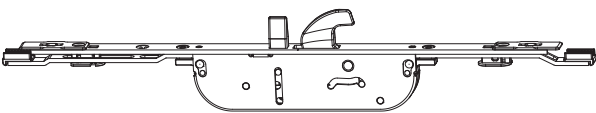

212646 

14.4.4 Faceplate module with magnetic cam			L		N <sup>o</sup>
Faceplate module with magnetic cam silver	F	16	350	5	<b>212646</b>
		20	350	5	<b>212761</b>
		24	350	5	<b>212765</b>
		24 /16	350	5	<b>213964</b>
	U	24	350	5	<b>215380</b>

212644 

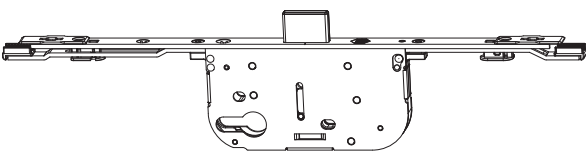
14.4.5 Faceplate module HO-BO			L		N <sup>o</sup>
faceplate module with HO-BO silver	F	16	350	5	<b>212644</b>
		20	350	5	<b>212759</b>
		24	350	5	<b>212763</b>
		24 /16	350	5	<b>213962</b>
	U	24	350	5	<b>215377</b>

212776 

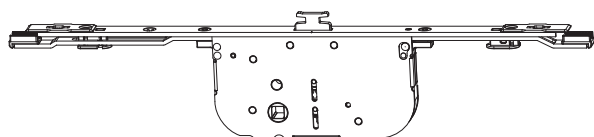

14.4.6 Faceplate module additional lock				L		N <sup>o</sup>
faceplate module with ZS silver	F	16	BS 35	350	5	<b>212645</b>
			BS 40	350	5	<b>212773</b>
			BS 45	350	5	<b>212774</b>
			BS 50	350	5	<b>212775</b>
			BS 55	350	5	<b>212776</b>
			BS 65	350	5	<b>212778</b>
	20	BS 35	350	5	<b>212760</b>	
		BS 40	350	5	<b>212889</b>	
		BS 45	350	5	<b>212890</b>	
		BS 50	350	5	<b>212891</b>	
		BS 55	350	5	<b>212892</b>	
		BS 65	350	5	<b>212894</b>	
	24	BS 35	350	5	<b>212764</b>	
		BS 40	350	5	<b>212895</b>	
		BS 45	350	5	<b>212896</b>	
		BS 50	350	5	<b>212897</b>	
		BS 55	350	5	<b>212898</b>	
		BS 65	350	5	<b>212900</b>	
	24 /16	BS 35	350	5	<b>213963</b>	
		BS 40	350	5	<b>213965</b>	
		BS 45	350	5	<b>213966</b>	
		BS 50	350	5	<b>213967</b>	
		BS 55	350	5	<b>213968</b>	
U	24	BS 65	350	5	<b>213969</b>	
		BS 35	350	5	<b>215378</b>	
		BS 45	350	5	<b>215379</b>	



213050





**14.4.7 Faceplate module for door restrictor**

faceplate module with TB silver





				L		N <sup>o</sup>
F	16	BS 35		350	5	<b>213046</b>
		BS 40		350	5	<b>213047</b>
		BS 45		350	5	<b>213048</b>
		BS 50		350	5	<b>213049</b>
		BS 55		350	5	<b>213050</b>
		BS 65		350	5	<b>213051</b>
	20	BS 35		350	5	<b>213054</b>
		BS 40		350	5	<b>213055</b>
		BS 45		350	5	<b>213056</b>
		BS 50		350	5	<b>213057</b>
		BS 55		350	5	<b>213058</b>
		BS 65		350	5	<b>213059</b>
	24	BS 35		350	5	<b>213062</b>
		BS 40		350	5	<b>213063</b>
		BS 45		350	5	<b>213064</b>
BS 50			350	5	<b>213065</b>	
BS 55			350	5	<b>213066</b>	
BS 65			350	5	<b>213067</b>	
24 /16	BS 35		350	5	<b>214030</b>	
	BS 40		350	5	<b>214031</b>	
	BS 45		350	5	<b>214032</b>	
	BS 50		350	5	<b>214033</b>	
	BS 55		350	5	<b>214034</b>	
	BS 65		350	5	<b>214035</b>	
U	24	BS 35		350	5	<b>215381</b>
		BS 45		350	5	<b>215382</b>

## 14.5 Accessories for B-TV MULTI TREND





55488 

14.5.1 End pieces top with i.S. without shootbolt protrusion				L		No
silver	1.850 - 2.100	16	1	650	10	55488
	2.101 - 2.350	16	1	900	10	55489
	2.351 - 2.600	16	2	1.150	10	55490

55171 

14.5.2 End pieces top with VZ without shootbolt protrusion				L		No
silver	1.850 - 2.100	16	1	650	10	55169
	2.101 - 2.350	16	1	900	10	55170
	2.351 - 2.600	16	2	1.150	10	55171

201458 

14.5.3 End pieces top with i.S. and shootbolt protrusion					L		No
silver	2.351 - 2.600	16	9	1	1.150	5	201458

55215 

14.5.4 End pieces top without cam with shootbolt protrusion			L		No
silver	1.850 - 2.100	16	650	10	55215
	2.101 - 2.350	16	900	10	55216

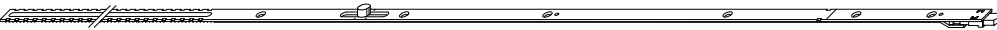
55217 

14.5.5 End pieces top with i.S. and shootbolt protrusion				L		No
silver	2.351 - 2.600	16	1	1.150	10	55217

55491 

14.5.6 End pieces bottom with i.S. without shootbolt protrusion				L		No
silver	1.850 - 2.600	16	1	400	10	55491



55172 

14.5.7 End pieces bottom with VZ without shootbolt protrusion				L		No
silver	1.850 - 2.600	16	1	400	10	55172

## 14.6 Accessories for B-TV MULTI MATIC

203697 

### 14.6.1 Faceplate extension B-TV

			L		No
silver	1	1.701 - 1.950	497	10	<b>203697</b>
		1.951 - 2.200	747	10	<b>203698</b>
	2	2.201 - 2.450	997	10	<b>203699</b>

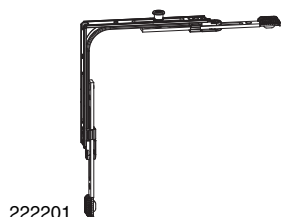





222201

### 14.6.2 Corner element B-TV

				No	
silver	with 1 i.S.	320 - 1.800	360 - 2.800	50	<b>222201</b>

225092 

### 14.6.3 End pieces bottom without cam with shootbolt protrusion

				L		No
silver	500 - 2.350	16	170	170	20	<b>225092</b>



203784

14.7 Roller latch for Z-TS PT-M		No
roller latch Z-TS BS 35 PT	10	203784
roller latch Z-TS BS 40 PT	10	203785
roller latch Z-TS BS 45 PT	10	203786
roller latch Z-TS BS 50 PT	10	203787
roller latch Z-TS BS 55 PT	10	203788
roller latch Z-TS BS 60 PT	10	203789
roller latch Z-TS BS 65 PT	10	203790
roller latch Z-TS BS 70 PT	10	203791
roller latch Z-TS BS 80 PT	10	203792

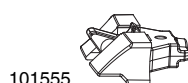

101555

14.8 Offset latch for Z-TS PT-M		No
offset latch Z-TS BS 35 PT	10	101555
offset latch Z-TS BS 40 PT	10	101556
offset latch Z-TS BS 45 PT	10	101553
offset latch Z-TS BS 50 PT	10	101557
offset latch Z-TS BS 55 PT	10	101477
offset latch Z-TS BS 65 PT	10	101558
offset latch Z-TS BS 70 PT	10	101559
offset latch Z-TS BS 80 PT	10	101560

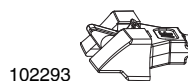

102293

14.9 Offset latch for Z-TF PT-M		No
offset latch MF for Z-TF with 4 mm ribbed washer	10	102293

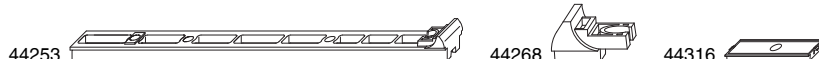

44253

44268

44316

14.10 Packer for shootbolt		No
packer for finger-operated door shootbolt 200mm for Eurogroove mm	20	360159
packer for shootbolt for Eurogroove mm silver	50	44253
Clip-On End Cap for Shootbolts	100	44268
Packer for Shootbolts	100	44316
packer for finger-operated door shootbolt right for Eurogroove mm	50	44372
packer for finger-operated door shootbolt left for Eurogroove mm	50	44373



43718

362920

360074

354358

44205

44206

14.11 Recess cover cap		No
clip-on end cap for right-angled latch plate timber 30mm rebate depth 13mm offset 30.0 black	100	369691
Clip-On End Cap for strikers and shootbolts Euro-rebate FT18 9V Silver	100	43718
clip-on end cap for right-angled latch plate 24 x 8 Euro-rebate 12 air gap, 24mm rebate depth 24.0 black	100	362920
clip-on end cap for latch striker plate Euro-rebate 18mm rebate depth 9mm offset mm	100	360074
Clip-On End Cap for striker Euro-rebate FT20 9V Silver	100	354358
clip-on end cap for striker plate right hardware groove mm silver	100	44205
adapter spacer for DL striker hardware groove left silver	100	44206



### 14.12 Recess cover caps



**N<sup>o</sup>**

Dust box cover Timber long right and left For timber profiles Black	50	<b>358024</b>
recess cover cap for latch and deadbolt striker black	50	<b>360397</b>
recess cover cap Z-TF latch and bolt striker for electric opener black -30,7x PT	100	<b>364326</b>
recess cover cap for latch and deadbolt striker for timber profiles silver	50	<b>43524</b>

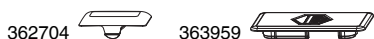

### 14.13 Cover caps



**N<sup>o</sup>**

cover for angled screw-fixing black	100	<b>362704</b>
cover cap latch and bolt striker black	100	<b>363959</b>



### 14.14 Faceplate strip covers



**N<sup>o</sup>**

extension for single piece door striker, timber U-6/24/6 silver	5	<b>102852</b>
faceplate strip cover silver F-1.400x20 PT	20	<b>364770</b>
faceplate strip cover silver F-1.400x24/16 PT	20	<b>364771</b>
faceplate strip cover silver U-1.000x24	5	<b>103001</b>
faceplate strip cover 1.400 silver	10	<b>94019</b>



### 14.15 Drill-in bushes for shootbolt



**N<sup>o</sup>**

drill-in bush for deadbolt 8x4 silver	100	<b>94219</b>
---------------------------------------	-----	--------------

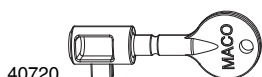

### 14.16 Universal access key



**N<sup>o</sup>**

universal access key	20	<b>40720</b>
----------------------	----	--------------

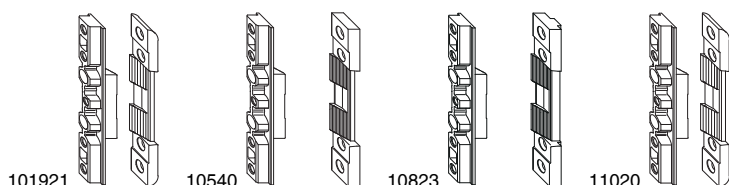

### 14.17 Turn-only hinge safety device



**N<sup>o</sup>**

turn-only hinge safety device for 4 mm air gap, 13 mm offset silver	20	<b>101921</b>
turn-only hinge safety device Euro-rebate 18 mm silver	20	<b>10540</b>
turn-only hinge safety device hardware groove silver	20	<b>10823</b>
turn-only hinge safety device for 4 mm air gap silver	20	<b>11020</b>



43586 

<b>14.18 Latch clips</b>			<b>Nº</b>
latch clips		50	<b>43586</b>
latch clip for offset latch		50	<b>362906</b>

369143 

<b>14.19 Latch elements</b>			<b>Nº</b>
Upper part latch element for PVC gasket compression -2 mm silver		50	<b>369143</b>

**MACO  
PROTECT**



**Accessories**



## 15 Jigs

---

<b>15.1</b>	<b>Striker plate jigs</b>	<b>216</b>
15.1.1	Drilling jig for main lock case	216
<b>15.2</b>	<b>Air gap jigs for Z-TA</b>	<b>216</b>

## 15 Jigs

### 15.1 Striker plate jigs

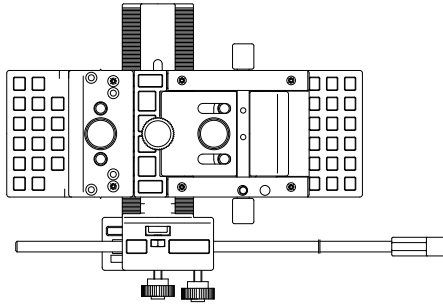

28603

#### 15.1.1 Drilling jig for main lock case



**N<sup>o</sup>**

drill jig for lock case

1

**28603**

### 15.2 Air gap jigs for Z-TA

**N<sup>o</sup>**

PVC rebate gap 20 mm sash overlap

**757154**

PVC rebate gap 21 mm sash overlap

**757155**

Timber 12 mm rebate gap 18 mm overlap

**757157**

Timber 12 mm rebate gap 20 mm overlap

**757156**

Timber 4 mm rebate gap 15 mm overlap

**757159**

Timber 4 mm rebate gap 18 mm overlap

**757158**





16 Directory

№		Page
1		
101072	10	201
101073	10	201,202
101477	10	211
101479	10	201
101480	10	201
101481	10	201
101482	10	201
101483	10	199
101484	10	200
101485	10	200
101486	10	200
101487	10	200
101488	10	200
101489	10	198
101490	10	198
101491	10	198
101492	10	199
101493	10	199
101494	10	201
101495	10	201
101496	10	201
101497	10	201
101498	10	201
101499	10	201
101500	10	199
101501	10	200
101502	10	200
101503	10	200
101504	10	200
101505	10	200
101506	10	198
101507	10	198
101508	10	198
101509	10	198
101510	10	198
101553	10	211
101555	10	211
101556	10	211
101557	10	211
101558	10	211
101559	10	211
101560	10	211
101921	20	212
101959	10	202
102219	10	206
102293	10	211
102363	10	202
102555	10	206
102556	10	206
102557	10	206
102745	10	206
102842	5	171
102843	5	171
102844	5	171
102845	5	171
102846	5	171
102847	5	171
102850	5	171
102851	5	171
102852	5	212
102929	10	206
102930	10	206
102933	5	172
102934	5	172
102935	5	172
102936	5	172
102937	5	172
102938	5	172
102939	5	172
102940	5	172
102964	5	172
102965	5	172
102966	5	172
102967	5	172
102990	5	172
102991	5	172
102992	5	172
102993	5	172
102994	5	172
102995	5	172
102996	5	172
102997	5	172
102998	20	179
103001	5	212



№		Page
103058	10	206
103059	10	206
103062	10	206
103372	5	172
103373	5	172
103413	20	170
103571	5	172
103572	5	172
104106	5	172
104107	5	172
104108	5	172
104109	5	172
104110	5	172
104111	5	172
104130	1	203
104785	10	203
104786	10	203
104787	10	203
104788	10	203
104789	10	203
104790	10	203
104791	10	203
104792	10	203
104793	10	203
104794	10	203
104902	10	202
10540	20	212
10792	50	183
10823	20	212
11020	20	212
11243	10	198
11244	10	198
2		
200981	10	201
200982	10	201,202
200983	10	200
200984	10	200
200985	10	200
200986	10	200
200987	10	200
201160	10	199
201161	10	199
201162	10	199
201163	10	199
201184	10	201
201185	10	201
201186	10	201
201455	5	151
201457	5	151
201458	5	209
201459	5	151
203329	100	169
203502	20	154
203503	20	154
203696	5	150
203697	10	210
203698	10	210
203699	10	210
203784	10	211
203785	10	211
203786	10	211
203787	10	211
203788	10	211
203789	10	211
203790	10	211
203791	10	211
203792	10	211
203828	5	150
203829	5	150
203830	5	150
203831	5	150
203832	5	150
203833	5	150
203834	5	150
203841	5	150
203842	5	150
203843	5	150
203844	5	150
203845	5	150
204048	5	152
204049	5	152
204050	5	152
204051	5	152
204052	5	152
204053	5	152
204060	5	152
206454	10	183
207861	20	157,165
207862	20	155,162

№		Page
208470	5	180
208471	5	180
208998	20	188,188,189
208999	20	188,188,189
209000	20	190
209104	20	170
209105	20	170
209338	100	160
209347	50	168
209355	20	202
209809	50	167
209810	50	167
209907	50	159
209908	50	159
209909	20	159
209911	20	160
209912	20	160
210016	20	167
210017	20	167
210501	20	155,163
210502	20	158,166
210779	20	167
210781	20	168
210782	20	168
210809	20	162
210810	20	162
210811	20	165
210812	20	165
210813	20	162
210814	20	162
210815	20	165
210816	20	165
210876	20	188
211369	100	169
211597	20	160
211598	20	168
211831	10	202
211835	10	202
211836	10	202
212282	20	178
212283	20	178
212411	5	182
212412	5	182
212413	5	182
212414	5	182
212415	5	182
212416	5	182
212419	5	184
212420	5	184
212421	5	184
212422	5	184
212474	100	169
212643	5	206
212644	5	207
212645	5	207
212646	5	207
212647	20	178
212758	5	206
212759	5	207
212760	5	207
212761	5	207
212762	5	206
212763	5	207
212764	5	207
212765	5	207
212767	10	198
212773	5	207
212774	5	207
212775	5	207
212776	5	207
212778	5	207
212889	5	207
212890	5	207
212891	5	207
212892	5	207
212894	5	207
212895	5	207
212896	5	207
212897	5	207
212898	5	207
212900	5	207
212936	20	156
212937	20	156
212938	20	158
212939	20	158
212940	20	163
212941	20	163
212942	20	166
212943	20	166
213046	5	208





<b>№</b>		<b>Page</b>	<b>№</b>		<b>Page</b>	<b>№</b>		<b>Page</b>
213047	5	208	215175	10	198	219036	20	178
213048	5	208	215176	5	200	219037	20	178
213049	5	208	215227	5	180	219038	5	180
213050	5	208	215228	5	180	219039	5	180
213051	5	208	215229	5	180	219040	5	180
213054	5	208	215230	5	180	219041	5	180
213055	5	208	215231	5	180	219042	5	180
213056	5	208	215232	5	180	219043	5	180
213057	5	208	215233	5	180	219183	20	178
213058	5	208	215234	5	180	219184	20	178
213059	5	208	215235	5	180	219231	20	154
213062	5	208	215236	5	180	219232	20	154
213063	5	208	215376	5	206	219233	20	162
213064	5	208	215377	5	207	219234	20	162
213065	5	208	215378	5	207	219235	20	157
213066	5	208	215379	5	207	219236	20	157
213067	5	208	215380	5	207	219237	20	165
213117	5	183	215381	5	208	219238	20	165
213118	5	183	215382	5	208	219258	20	170
213180	20	179	215395	5	206	219259	20	170
213237	20	178	215396	5	206	219260	20	170
213239	20	178	215424	20	170	219376	20	161
213240	20	178	215425	20	170	219378	20	161
213241	20	178	215497	20	170	219423	5	182
213325	20	163	215683	20	161	219424	5	182
213326	20	166	215684	20	161	219425	5	182
213621	5	184	215685	20	161	219426	5	182
213622	5	184	215715	5	173	219427	5	182
213623	5	184	215716	5	173	219428	5	182
213624	5	184	215717	5	173	219438	5	184
213825	20	189	215718	5	173	219439	5	184
213826	20	189	215719	5	173	219440	5	184
213829	20	189	215720	5	173	219441	5	184
213830	20	189	215721	5	173	219442	5	186
213831	20	189	215858	5	184	219443	5	186
213832	20	189	215859	10	184	219444	10	184
213833	20	188	215862	10	184	219445	5	184
213834	20	188	215863	5	184	219446	5	184
213961	5	206	215907	5	171	219527	5	173
213962	5	207	215908	5	171	219528	5	173
213963	5	207	215909	5	171	219529	5	173
213964	5	207	215910	5	171	219530	5	173
213965	5	207	215911	5	171	219531	5	173
213966	5	207	215912	5	171	219532	5	173
213967	5	207	216254	5	185	219586	5	183
213968	5	207	216255	5	185	219588	5	183
213969	5	207	216256	5	185	219589	5	183
214030	5	208	216257	5	185	219590	5	183
214031	5	208	216258	5	186	219591	5	182
214032	5	208	216259	5	186	219592	5	182
214033	5	208	216294	5	185	219593	5	182
214034	5	208	216295	5	185	219594	5	182
214035	5	208	216296	5	185	219798	5	182
214190	5	171	216297	5	185	219799	5	182
214191	5	171	216298	5	186	219800	5	182
214208	5	182	216299	5	186	219801	5	182
214209	5	182	216637	5	171	219802	5	182
214210	5	182	216638	5	171	219803	5	182
214211	5	182	216690	5	173	220298	5	151
214216	5	183	216691	5	173	220299	5	151
214217	5	183	216754	20	179	221097	20	188
214218	5	183	216755	20	179	222201	50	210
214219	5	183	216863	20	160	224649	5	171
214407	20	178	216864	20	160	224650	5	171
214408	20	178	216865	20	168	224651	5	171
214409	20	178	216866	20	168	224652	5	171
214455	20	159,167	216977	20	178	224969	20	178
214456	20	159,167	216981	20	178	224970	20	178
214457	20	160,168	217036	5	173	224971	5	180
214458	20	160,168	217037	5	173	224972	5	180
214459	20	160,168	217038	5	173	224973	5	180
214466	5	180	217039	5	173	224974	5	180
214467	5	180	217040	5	173	224975	5	180
214504	20	163	217041	5	173	224976	5	180
214505	20	166	217144	5	182	225092	20	210
214527	20	155	217145	5	182	226489	20	170
214965	20	163	217154	5	183	226490	20	170
214966	20	165	217155	5	183	226733	5	171
214968	20	155,157	217676	20	170	226734	5	171
215098	5	206	218784	5	171	226810	20	159,167
215099	5	206	218785	5	171	226811	5	159,167
215100	5	206	218901	20	159,167	227051	5	203
215101	5	206	218902	20	159,167	227052	5	203
215102	5	206	218903	20	154	227053	5	203
215103	5	206	218904	20	154	227054	5	203
215104	5	206	218939	20	155	227055	5	203
215105	5	206	218940	20	155	227065	5	160,168
215154	5	199	218941	20	163	227136	5	183
215160	5	200	218942	20	163	227137	5	183
215164	5	200	218943	20	157	227388	20	178
215167	10	198	218944	20	157	227538	20	204
215169	10	198	219030	5	183	227597	10	202
215170	5	200	219031	5	183	227598	10	202
215172	10	198	219032	5	182	227599	10	202
215173	5	200	219033	5	182	227600	10	202





<b>№</b>		<b>Page</b>	<b>№</b>		<b>Page</b>	<b>№</b>		<b>Page</b>
227601	10	202	231475	5	82	233687	5	119
227602	10	202	231476	5	82	233751	5	124
230010	5	80	231477	5	82	233752	5	124
230011	5	80	232010	5	118	233753	5	124
230012	5	80	232011	5	118	233754	5	124
230013	5	80	232012	5	118	233755	5	124
230014	5	80	232013	5	118	233756	5	124
230015	5	80	232014	5	118	233757	5	124
230016	5	80	232015	5	118	233860	5	122
230017	5	80	232016	5	118	233861	5	122
230020	5	78	232017	5	118	233862	5	122
230021	5	78	232140	5	120	233863	5	122
230022	5	78	232141	5	120	233864	5	122
230023	5	78	232142	5	120	233865	5	122
230024	5	78	232143	5	120	233866	5	122
230025	5	78	232144	5	120	233867	5	122
230026	5	78	232145	5	120	233941	5	122
230027	5	78	232146	5	120	233942	5	122
230250	5	80	232147	5	120	233943	5	122
230251	5	80	232170	5	120	233944	5	122
230252	5	80	232171	5	120	233945	5	122
230253	5	80	232172	5	120	233946	5	122
230254	5	80	232173	5	120	233947	5	122
230255	5	80	232174	5	120	233990	5	90
230256	5	80	232175	5	120	233991	5	90
230257	5	80	232176	5	120	233992	5	90
230260	5	78	232177	5	120	233993	5	90
230261	5	78	232210	5	118	233994	5	90
230262	5	78	232211	5	118	233995	5	90
230263	5	78	232212	5	118	233996	5	90
230264	5	78	232213	5	118	233997	5	90
230265	5	78	232214	5	118	234000	5	90
230266	5	78	232215	5	118	234001	5	90
230267	5	78	232216	5	118	234002	5	90
230690	5	78	232217	5	118	234003	5	90
230691	5	78	232500	5	118	234004	5	90
230692	5	78	232501	5	118	234005	5	90
230693	5	78	232502	5	118	234006	5	90
230694	5	78	232503	5	118	234007	5	90
230695	5	78	232504	5	118	234030	5	94
230696	5	78	232505	5	118	234031	5	94
230697	5	78	232506	5	118	234032	5	94
230760	5	78	232507	5	118	234033	5	94
230761	5	78	232570	5	118	234034	5	94
230762	5	78	232571	5	118	234035	5	94
230763	5	78	232572	5	118	234036	5	94
230764	5	78	232573	5	118	234037	5	94
230765	5	78	232574	5	118	234040	5	94
230766	5	78	232575	5	118	234041	5	94
230767	5	78	232576	5	118	234042	5	94
230930	5	79	232577	5	118	234043	5	94
230931	5	79	233440	5	122	234044	5	94
230932	5	79	233441	5	122	234045	5	94
230933	5	79	233442	5	122	234046	5	94
230934	5	79	233443	5	122	234047	5	94
230935	5	79	233444	5	122	234180	5	78
230936	5	79	233445	5	122	234181	5	78
230937	5	79	233446	5	122	234182	5	78
231240	5	79	233447	5	122	234183	5	78
231241	5	79	233450	5	122	234184	5	79
231242	5	79	233451	5	122	234185	5	79
231243	5	79	233452	5	122	234200	5	45
231244	5	79	233453	5	122	234201	5	45
231245	5	79	233454	5	122	234202	5	45
231246	5	79	233455	5	122	234203	5	45
231247	5	79	233456	5	122	234204	5	45
231420	5	82	233457	5	122	234205	5	45
231421	5	82	233480	5	133	234206	5	45
231422	5	82	233481	5	133	234207	5	45
231423	5	82	233482	5	133	234220	5	49
231424	5	82	233483	5	133	234221	5	49
231425	5	82	233484	5	133	234222	5	49
231426	5	82	233485	5	133	234223	5	49
231427	5	82	233486	5	133	234224	5	49
231430	5	82	233487	5	133	234225	5	49
231431	5	82	233571	5	119	234226	5	49
231432	5	82	233572	5	119	234227	5	49
231433	5	82	233573	5	119	234230	5	46
231434	5	82	233574	5	119	234231	5	46
231435	5	82	233575	5	119	234232	5	46
231436	5	82	233576	5	119	234233	5	46
231437	5	82	233577	5	119	234234	5	46
231460	5	82	233671	5	123	234235	5	46
231461	5	82	233672	5	123	234236	5	46
231462	5	82	233673	5	123	234237	5	46
231463	5	82	233674	5	123	234250	5	50
231464	5	82	233675	5	123	234251	5	50
231465	5	82	233676	5	123	234252	5	50
231466	5	82	233677	5	123	234253	5	50
231467	5	82	233681	5	119	234254	5	50
231470	5	82	233682	5	119	234255	5	50
231471	5	82	233683	5	119	234256	5	50
231472	5	82	233684	5	119	234257	5	50
231473	5	82	233685	5	119	234270	5	100
231474	5	82	233686	5	119	234271	5	100





<b>№</b>		<b>Page</b>	<b>№</b>		<b>Page</b>	<b>№</b>		<b>Page</b>
234272	5	100	234471	5	109	234770	5	45
234273	5	100	234472	5	109	234771	5	45
234274	5	100	234473	5	109	234772	5	45
234275	5	100	234474	5	109	234773	5	45
234276	5	100	234475	5	109	234774	5	45
234277	5	100	234476	5	109	234775	5	45
234280	5	49	234477	5	109	234776	5	45
234281	5	49	234490	5	107	234777	5	45
234282	5	49	234491	5	107	234790	5	46
234283	5	49	234492	5	107	234791	5	46
234284	5	49	234493	5	107	234792	5	46
234285	5	49	234494	5	107	234793	5	46
234286	5	49	234495	5	107	234794	5	46
234287	5	49	234496	5	107	234795	5	46
234290	5	96	234497	5	107	234796	5	46
234291	5	96	234500	5	103	234797	5	46
234292	5	96	234501	5	103	234800	5	91
234293	5	96	234502	5	103	234801	5	91
234294	5	96	234503	5	103	234802	5	91
234295	5	96	234504	5	103	234803	5	91
234296	5	96	234505	5	103	234804	5	91
234297	5	96	234506	5	103	234805	5	91
234310	5	100	234507	5	103	234806	5	91
234311	5	100	234510	5	103	234807	5	91
234312	5	100	234511	5	103	234810	5	91
234313	5	100	234512	5	103	234811	5	91
234314	5	100	234513	5	103	234812	5	91
234315	5	100	234514	5	103	234813	5	91
234316	5	100	234515	5	103	234814	5	91
234317	5	100	234516	5	103	234815	5	91
234320	5	97	234517	5	103	234816	5	91
234321	5	97	234520	5	109	234817	5	91
234322	5	97	234521	5	109	234870	5	130
234323	5	97	234522	5	109	234871	5	130
234324	5	97	234523	5	109	234872	5	130
234325	5	97	234524	5	109	234873	5	130
234326	5	97	234525	5	109	234874	5	130
234327	5	97	234526	5	109	234875	5	130
234330	5	97	234527	5	109	234876	5	130
234331	5	97	234530	5	109	234877	5	130
234332	5	97	234531	5	109	234880	5	127
234333	5	97	234532	5	109	234881	5	127
234334	5	97	234533	5	109	234882	5	127
234335	5	97	234534	5	109	234883	5	127
234336	5	97	234535	5	109	234884	5	127
234337	5	97	234536	5	109	234885	5	127
234340	5	101	234537	5	109	234886	5	127
234341	5	101	234560	5	104	234887	5	127
234342	5	101	234561	5	104	234890	5	123
234343	5	101	234562	5	104	234891	5	123
234344	5	101	234563	5	104	234892	5	123
234345	5	101	234564	5	104	234893	5	123
234346	5	101	234565	5	104	234894	5	123
234347	5	101	234566	5	104	234895	5	123
234350	5	101	234567	5	104	234896	5	123
234351	5	101	234570	5	104	234897	5	123
234352	5	101	234571	5	104	234900	5	130
234353	5	101	234572	5	104	234901	5	130
234354	5	101	234573	5	104	234902	5	130
234355	5	101	234574	5	104	234903	5	130
234356	5	101	234575	5	104	234904	5	130
234357	5	101	234576	5	104	234905	5	130
234380	5	97	234577	5	104	234906	5	130
234381	5	97	234600	5	103	234907	5	130
234382	5	97	234601	5	103	234910	5	127
234383	5	97	234602	5	103	234911	5	127
234384	5	97	234603	5	103	234912	5	127
234385	5	97	234604	5	103	234913	5	127
234386	5	97	234605	5	103	234914	5	127
234387	5	97	234606	5	103	234915	5	127
234390	5	97	234607	5	103	234916	5	127
234391	5	97	234610	5	109	234917	5	127
234392	5	97	234611	5	109	234920	5	125
234393	5	97	234612	5	109	234921	5	125
234394	5	97	234613	5	109	234922	5	125
234395	5	97	234614	5	109	234923	5	125
234396	5	97	234615	5	109	234924	5	125
234397	5	97	234616	5	109	234925	5	125
234430	5	107	234617	5	109	234926	5	125
234431	5	107	234620	5	96	234927	5	125
234432	5	107	234621	5	96	234930	5	125
234433	5	107	234622	5	96	234931	5	125
234434	5	107	234623	5	96	234932	5	125
234435	5	107	234624	5	96	234933	5	125
234436	5	107	234625	5	96	234934	5	125
234437	5	107	234626	5	96	234935	5	125
234450	5	103	234627	5	96	234936	5	125
234451	5	103	234630	5	50	234937	5	125
234452	5	103	234631	5	50	234940	5	121
234453	5	103	234632	5	50	234941	5	121
234454	5	103	234633	5	50	234942	5	121
234455	5	103	234634	5	50	234943	5	121
234456	5	103	234635	5	50	234944	5	121
234457	5	103	234636	5	50	234945	5	121
234470	5	109	234637	5	50	234946	5	121



<b>№</b>		<b>Page</b>	<b>№</b>		<b>Page</b>	<b>№</b>		<b>Page</b>
234947	5	121	235296	5	124	235865	5	84
234950	5	126	235297	5	124	235866	5	84
234951	5	126	235340	5	45	235867	5	84
234952	5	126	235341	5	45	235890	5	85
234953	5	126	235342	5	45	235891	5	85
234954	5	126	235343	5	45	235892	5	85
234955	5	126	235344	5	45	235893	5	85
234956	5	126	235345	5	45	235894	5	85
234957	5	126	235346	5	45	235895	5	85
234960	5	121	235347	5	45	235896	5	85
234961	5	121	235350	5	45	235897	5	85
234962	5	121	235351	5	45	235900	5	85
234963	5	121	235352	5	45	235901	5	85
234964	5	121	235353	5	45	235902	5	85
234965	5	121	235354	5	45	235903	5	85
234966	5	121	235355	5	45	235904	5	85
234967	5	121	235356	5	45	235905	5	85
234970	5	129	235357	5	45	235906	5	85
234971	5	129	235370	5	47	235907	5	85
234972	5	129	235371	5	47	235925	5	88,88
234973	5	129	235372	5	47	236000	5	80
234974	5	129	235373	5	47	236001	5	80
234975	5	129	235374	5	47	236002	5	80
234976	5	129	235375	5	47	236003	5	80
234977	5	129	235376	5	47	236004	5	80
234980	5	126	235377	5	47	236005	5	80
234981	5	126	235380	5	47	236006	5	80
234982	5	126	235381	5	47	236007	5	80
234983	5	126	235382	5	47	236010	5	88
234984	5	126	235383	5	47	236011	5	88
234985	5	126	235384	5	47	236012	5	88
234986	5	126	235385	5	47	236013	5	88
234987	5	126	235386	5	47	236014	5	88
234990	5	121	235387	5	47	236015	5	88
234991	5	121	235770	5	44	236016	5	88
234992	5	121	235771	5	44	236017	5	88
234993	5	121	235772	5	44	236020	5	89
234994	5	121	235773	5	44	236021	5	89
234995	5	121	235774	5	44	236022	5	89
234996	5	121	235775	5	44	236023	5	89
234997	5	121	235776	5	44	236024	5	89
235000	5	129	235777	5	44	236025	5	89
235001	5	129	235780	5	44	236026	5	89
235002	5	129	235781	5	44	236027	5	89
235003	5	129	235782	5	44	236030	5	81
235004	5	129	235783	5	44	236031	5	81
235005	5	129	235784	5	44	236032	5	81
235006	5	129	235785	5	44	236033	5	81
235007	5	129	235786	5	44	236034	5	81
235010	5	126	235787	5	44	236035	5	81
235011	5	126	235800	5	88	236036	5	81
235012	5	126	235801	5	88	236037	5	81
235013	5	126	235802	5	88	236050	5	92
235014	5	126	235803	5	88	236051	5	92
235015	5	126	235804	5	88	236052	5	92
235016	5	126	235805	5	88	236053	5	92
235017	5	126	235806	5	88	236054	5	92
235110	5	90	235807	5	88	236055	5	92
235111	5	90	235810	5	84	236056	5	92
235112	5	90	235811	5	84	236057	5	92
235113	5	90	235812	5	84	236070	5	93
235114	5	90	235813	5	84	236071	5	93
235115	5	90	235814	5	84	236072	5	93
235116	5	90	235815	5	84	236073	5	93
235117	5	90	235816	5	84	236074	5	93
235120	5	90	235817	5	84	236075	5	93
235121	5	90	235820	5	84	236076	5	93
235122	5	90	235821	5	84	236077	5	93
235123	5	90	235822	5	84	236590	5	86
235124	5	90	235823	5	84	236591	5	86
235125	5	90	235824	5	84	236592	5	86
235126	5	90	235825	5	84	236593	5	86
235127	5	90	235826	5	84	236594	5	86
235150	5	94	235827	5	84	236595	5	86
235151	5	94	235840	5	88	236596	5	86
235152	5	94	235841	5	88	236597	5	86
235153	5	94	235842	5	88	236600	5	86
235154	5	94	235843	5	88	236601	5	86
235155	5	94	235844	5	88	236602	5	86
235156	5	94	235845	5	88	236603	5	86
235157	5	94	235846	5	88	236604	5	86
235160	5	94	235847	5	88	236605	5	86
235161	5	94	235850	5	84	236606	5	86
235162	5	94	235851	5	84	236607	5	86
235163	5	94	235852	5	84	236810	5	130
235164	5	94	235853	5	84	236811	5	130
235165	5	94	235854	5	84	236812	5	130
235166	5	94	235855	5	84	236813	5	130
235167	5	94	235856	5	84	236814	5	130
235290	5	124	235857	5	84	236815	5	130
235291	5	124	235860	5	84	236816	5	130
235292	5	124	235861	5	84	236817	5	130
235293	5	124	235862	5	84	236820	5	129
235294	5	124	235863	5	84	236821	5	129
235295	5	124	235864	5	84	236822	5	129



<b>№</b>		<b>Page</b>	<b>№</b>		<b>Page</b>	<b>№</b>		<b>Page</b>
236823	5	129	237250	5	68	237486	5	66
236824	5	129	237251	5	68	237487	5	66
236825	5	129	237252	5	68	237590	5	79
236826	5	129	237253	5	68	237591	5	79
236827	5	129	237254	5	68	237592	5	79
236830	5	127	237255	5	68	237593	5	79
236831	5	127	237256	5	68	237594	5	79
236832	5	127	237257	5	68	237595	5	79
236833	5	127	237270	5	64	237596	5	79
236834	5	127	237271	5	64	237597	5	79
236835	5	127	237272	5	64	237600	5	79
236836	5	127	237273	5	64	237601	5	79
236837	5	127	237274	5	64	237602	5	79
236840	5	123	237275	5	64	237603	5	79
236841	5	123	237276	5	64	237604	5	79
236842	5	123	237277	5	64	237605	5	79
236843	5	123	237280	5	64	237606	5	79
236844	5	123	237281	5	64	237607	5	79
236845	5	123	237282	5	64	237620	5	85
236846	5	123	237283	5	64	237621	5	85
236847	5	123	237284	5	64	237622	5	85
236850	5	128	237285	5	64	237623	5	85
236851	5	128	237286	5	64	237624	5	85
236852	5	128	237287	5	64	237625	5	85
236853	5	128	237300	5	69	237626	5	85
236854	5	128	237301	5	69	237627	5	85
236855	5	128	237302	5	69	237630	5	85
236856	5	128	237303	5	69	237631	5	85
236857	5	128	237304	5	69	237632	5	85
237010	5	63	237305	5	69	237633	5	85
237011	5	63	237306	5	69	237634	5	85
237012	5	63	237307	5	69	237635	5	85
237013	5	63	23731	100	164	237636	5	85
237014	5	63	237320	5	60	237637	5	85
237015	5	63	237321	5	60	237650	5	47
237016	5	63	237322	5	60	237651	5	47
237017	5	63	237323	5	60	237652	5	47
237140	5	81	237324	5	60	237653	5	47
237141	5	81	237325	5	60	237654	5	47
237142	5	81	237326	5	60	237655	5	47
237143	5	81	237327	5	60	237656	5	47
237144	5	81	237330	5	60	237657	5	47
237145	5	81	237331	5	60	237660	5	47
237146	5	81	237332	5	60	237661	5	47
237147	5	81	237333	5	60	237662	5	47
237150	5	57	237334	5	60	237663	5	47
237151	5	57	237335	5	60	237664	5	47
237152	5	57	237336	5	60	237665	5	47
237153	5	57	237337	5	60	237666	5	47
237154	5	57	237350	5	66	237667	5	47
237155	5	57	237351	5	66	237680	5	48
237156	5	57	237352	5	66	237681	5	48
237157	5	57	237353	5	66	237682	5	48
237160	5	131	237354	5	66	237683	5	48
237161	5	131	237355	5	66	237684	5	48
237162	5	131	237356	5	66	237685	5	48
237163	5	131	237357	5	66	237686	5	48
237164	5	131	237370	5	60	237687	5	48
237165	5	131	237371	5	60	237690	5	48
237166	5	131	237372	5	60	237691	5	48
237167	5	131	237373	5	60	237692	5	48
237173	5	132	237374	5	60	237693	5	48
237174	5	132	237375	5	60	237694	5	48
237180	5	63	237376	5	60	237695	5	48
237181	5	63	237377	5	60	237696	5	48
237182	5	63	237380	5	60	237697	5	48
237183	5	63	237381	5	60	237730	5	52
237184	5	63	237382	5	60	237731	5	52
237185	5	63	237383	5	60	237732	5	52
237186	5	63	237384	5	60	237733	5	52
237187	5	63	237385	5	60	237734	5	52
237200	5	68	237386	5	60	237735	5	52
237201	5	68	237387	5	60	237736	5	52
237202	5	68	237390	5	61	237737	5	52
237203	5	68	237391	5	61	237750	5	52
237204	5	68	237392	5	61	237751	5	52
237205	5	68	237393	5	61	237752	5	52
237206	5	68	237394	5	61	237753	5	52
237207	5	68	237395	5	61	237754	5	52
237220	5	63	237396	5	61	237755	5	52
237221	5	63	237397	5	61	237756	5	52
237222	5	63	237400	5	61	237757	5	52
237223	5	63	237401	5	61	237760	5	55
237224	5	63	237402	5	61	237761	5	55
237225	5	63	237403	5	61	237762	5	55
237226	5	63	237404	5	61	237763	5	55
237227	5	63	237405	5	61	237764	5	55
237230	5	63	237406	5	61	237765	5	55
237231	5	63	237407	5	61	237766	5	55
237232	5	63	237480	5	66	237767	5	55
237233	5	63	237481	5	66	237790	5	52
237234	5	63	237482	5	66	237791	5	52
237235	5	63	237483	5	66	237792	5	52
237236	5	63	237484	5	66	237793	5	52
237237	5	63	237485	5	66	237794	5	52



**№**  **Page**

237795	5	52
237796	5	52
237797	5	52
237810	5	52
237811	5	52
237812	5	52
237813	5	52
237814	5	52
237815	5	52
237816	5	52
237817	5	52
237820	5	55
237821	5	55
237822	5	55
237823	5	55
237824	5	55
237825	5	55
237826	5	55
237827	5	55
237850	5	44
237851	5	44
237852	5	44
237853	5	44
237854	5	44
237855	5	44
237856	5	44
237857	5	44
237870	5	44
237871	5	44
237872	5	44
237873	5	44
237874	5	44
237875	5	44
237876	5	44
237877	5	44
237880	5	49
237881	5	49
237882	5	49
237883	5	49
237884	5	49
237885	5	49
237886	5	49
237887	5	49
237910	5	53
237911	5	53
237912	5	53
237913	5	53
237914	5	53
237915	5	53
237916	5	53
237917	5	53
237930	5	53
237931	5	53
237932	5	53
237933	5	53
237934	5	53
237935	5	53
237936	5	53
237937	5	53
237940	5	56
237941	5	56
237942	5	56
237943	5	56
237944	5	56
237945	5	56
237946	5	56
237947	5	56
237970	5	53
237971	5	53
237972	5	53
237973	5	53
237974	5	53
237975	5	53
237976	5	53
237977	5	53
237990	5	53
237991	5	53
237992	5	53
237993	5	53
237994	5	53
237995	5	53
237996	5	53
237997	5	53
238000	5	56
238001	5	56
238002	5	56
238003	5	56
238004	5	56
238005	5	56
238006	5	56
238007	5	56
238030	5	46
238031	5	46
238032	5	46
238033	5	46



**№**  **Page**

238034	5	46
238035	5	46
238036	5	46
238037	5	46
238050	5	46
238051	5	46
238052	5	46
238053	5	46
238054	5	46
238055	5	46
238056	5	46
238057	5	46
238060	5	50
238061	5	50
238062	5	50
238063	5	50
238064	5	50
238065	5	50
238066	5	50
238067	5	50
238090	5	54
238091	5	54
238092	5	54
238093	5	54
238094	5	54
238095	5	54
238096	5	54
238097	5	54
238110	5	54
238111	5	54
238112	5	54
238113	5	54
238114	5	54
238115	5	54
238116	5	54
238117	5	54
238120	5	56
238121	5	56
238122	5	56
238123	5	56
238124	5	56
238125	5	56
238126	5	56
238127	5	56
238150	5	55
238151	5	55
238152	5	55
238153	5	55
238154	5	55
238155	5	55
238156	5	55
238157	5	55
238170	5	55
238171	5	55
238172	5	55
238173	5	55
238174	5	55
238175	5	55
238176	5	55
238177	5	55
238180	5	56
238181	5	56
238182	5	56
238183	5	56
238184	5	56
238185	5	56
238186	5	56
238187	5	56
238210	5	48
238211	5	48
238212	5	48
238213	5	48
238214	5	48
238215	5	48
238216	5	48
238217	5	48
238230	5	48
238231	5	48
238232	5	48
238233	5	48
238234	5	48
238235	5	48
238236	5	48
238237	5	48
238240	5	51
238241	5	51
238242	5	51
238243	5	51
238244	5	51
238245	5	51
238246	5	51
238247	5	51
238270	5	54
238271	5	54
238272	5	54



**№**  **Page**

238273	5	54
238274	5	54
238275	5	54
238276	5	54
238277	5	54
238290	5	54
238291	5	54
238292	5	54
238293	5	54
238294	5	54
238295	5	54
238296	5	54
238297	5	54
238350	5	96
238351	5	96
238352	5	96
238353	5	96
238354	5	96
238355	5	96
238356	5	96
238357	5	96
238360	5	96
238361	5	96
238362	5	96
238363	5	96
238364	5	96
238365	5	96
238366	5	96
238367	5	96
238370	5	51
238371	5	51
238372	5	51
238373	5	51
238374	5	51
238375	5	51
238376	5	51
238377	5	51
238420	5	51
238421	5	51
238422	5	51
238423	5	51
238424	5	51
238425	5	51
238426	5	51
238427	5	51
238462	5	89
238482	5	108
238500	5	107
238501	5	107
238502	5	107
238503	5	107
238504	5	107
238505	5	107
238506	5	107
238507	5	107
238520	5	108
238521	5	108
238522	5	108
238523	5	108
238524	5	108
238525	5	108
238526	5	108
238527	5	108
238540	5	108
238541	5	108
238542	5	108
238543	5	108
238544	5	108
238545	5	108
238546	5	108
238547	5	108
238560	5	83
238561	5	83
238562	5	83
238563	5	83
238564	5	83
238565	5	83
238566	5	83
238567	5	83
238570	5	83
238571	5	83
238572	5	83
238573	5	83
238574	5	83
238575	5	83
238576	5	83
238577	5	83
238610	5	102
238611	5	102
238612	5	102
238613	5	102
238614	5	102
238615	5	102
238616	5	102
238617	5	102





№		Page	№		Page	№		Page
238621	5	102	239047	5	57	239246	5	59
238622	5	102	239050	5	57	239247	5	59
238623	5	102	239051	5	57	239250	5	59
238624	5	102	239052	5	57	239251	5	59
238625	5	102	239053	5	57	239252	5	59
238626	5	102	239054	5	57	239253	5	59
238627	5	102	239055	5	57	239254	5	59
238660	5	95	239056	5	57	239255	5	59
238661	5	95	239057	5	57	239256	5	59
238662	5	95	239070	5	64	239257	5	59
238663	5	95	239071	5	64	239270	5	66
238664	5	95	239072	5	64	239271	5	66
238665	5	95	239073	5	64	239272	5	66
238666	5	95	239074	5	64	239273	5	66
238667	5	95	239075	5	64	239274	5	66
238670	5	95	239076	5	64	239275	5	66
238671	5	95	239077	5	64	239276	5	66
238672	5	95	239090	5	58	239277	5	66
238673	5	95	239091	5	58	239300	5	67
238674	5	95	239092	5	58	239301	5	67
238675	5	95	239093	5	58	239302	5	67
238676	5	95	239094	5	58	239303	5	67
238677	5	95	239095	5	58	239304	5	67
238710	5	83	239096	5	58	239305	5	67
238711	5	83	239097	5	58	239306	5	67
238712	5	83	239100	5	58	239307	5	67
238713	5	83	239101	5	58	239320	5	61
238714	5	83	239102	5	58	239321	5	61
238715	5	83	239103	5	58	239322	5	61
238716	5	83	239104	5	58	239323	5	61
238717	5	83	239105	5	58	239324	5	61
238720	5	83	239106	5	58	239325	5	61
238721	5	83	239107	5	58	239326	5	61
238722	5	83	239120	5	65	239327	5	61
238723	5	83	239121	5	65	239330	5	61
238724	5	83	239122	5	65	239331	5	61
238725	5	83	239123	5	65	239332	5	61
238726	5	83	239124	5	65	239333	5	61
238727	5	83	239125	5	65	239334	5	61
238760	5	102	239126	5	65	239335	5	61
238761	5	102	239127	5	65	239336	5	61
238762	5	102	239140	5	58	239337	5	61
238763	5	102	239141	5	58	239350	5	67
238764	5	102	239142	5	58	239351	5	67
238765	5	102	239143	5	58	239352	5	67
238766	5	102	239144	5	58	239353	5	67
238767	5	102	239145	5	58	239354	5	67
238771	5	102	239146	5	58	239355	5	67
238772	5	102	239147	5	58	239356	5	67
238773	5	102	239150	5	58	239357	5	67
238774	5	102	239151	5	58	239370	5	62
238775	5	102	239152	5	58	239371	5	62
238776	5	102	239153	5	58	239372	5	62
238777	5	102	239154	5	58	239373	5	62
238810	5	95	239155	5	58	239374	5	62
238811	5	95	239156	5	58	239375	5	62
238812	5	95	239157	5	58	239376	5	62
238813	5	95	239170	5	65	239377	5	62
238814	5	95	239171	5	65	239380	5	62
238815	5	95	239172	5	65	239381	5	62
238816	5	95	239173	5	65	239382	5	62
238817	5	95	239174	5	65	239383	5	62
238820	5	95	239175	5	65	239384	5	62
238821	5	95	239176	5	65	239385	5	62
238822	5	95	239177	5	65	239386	5	62
238823	5	95	239190	5	59	239387	5	62
238824	5	95	239191	5	59	239400	5	67
238825	5	95	239192	5	59	239401	5	67
238826	5	95	239193	5	59	239402	5	67
238827	5	95	239194	5	59	239403	5	67
23883	100	156	239195	5	59	239404	5	67
23886	100	164	239196	5	59	239405	5	67
239000	5	57	239197	5	59	239406	5	67
239001	5	57	239200	5	59	239407	5	67
239002	5	57	239201	5	59	239420	5	62
239003	5	57	239202	5	59	239421	5	62
239004	5	57	239203	5	59	239422	5	62
239005	5	57	239204	5	59	239423	5	62
239006	5	57	239205	5	59	239424	5	62
239007	5	57	239206	5	59	239425	5	62
239020	5	64	239207	5	59	239426	5	62
239021	5	64	239220	5	65	239427	5	62
239022	5	64	239221	5	65	239430	5	62
239023	5	64	239222	5	65	239431	5	62
239024	5	64	239223	5	65	239432	5	62
239025	5	64	239224	5	65	239433	5	62
239026	5	64	239225	5	65	239434	5	62
239027	5	64	239226	5	65	239435	5	62
239040	5	57	239227	5	65	239436	5	62
239041	5	57	239240	5	59	239437	5	62
239042	5	57	239241	5	59	239450	5	68
239043	5	57	239242	5	59	239451	5	68
239044	5	57	239243	5	59	239452	5	68
239045	5	57	239244	5	59	239453	5	68
239046	5	57	239245	5	59	239454	5	68





<b>№</b>		<b>Page</b>	<b>№</b>		<b>Page</b>	<b>№</b>		<b>Page</b>
239455	5	68	240287	5	124	241268	5	29
239456	5	68	240460	5	89	241280	5	24
239457	5	68	240461	5	89	241281	5	24
239470	5	104	240462	5	89	241282	5	24
239471	5	104	240463	5	89	241283	5	24
239472	5	104	240464	5	89	241284	5	24
239473	5	104	240465	5	89	241285	5	24
239474	5	104	240466	5	89	241286	5	24
239475	5	104	240467	5	89	241287	5	24
239476	5	104	240781	5	120	241288	5	24
239477	5	104	240782	5	120	241290	5	30
239480	5	104	240783	5	120	241291	5	30
239481	5	104	240784	5	120	241292	5	30
239482	5	104	240785	5	120	241293	5	30
239483	5	104	240786	5	120	241294	5	30
239484	5	104	240787	5	120	241295	5	30
239485	5	104	240791	5	131	241296	5	30
239486	5	104	240792	5	131	241297	5	30
239487	5	104	240793	5	131	241298	5	30
239490	5	98	240794	5	131	241310	5	19
239491	5	98	240795	5	131	241311	5	19
239492	5	98	240796	5	131	241312	5	19
239493	5	98	240797	5	131	241313	5	19
239494	5	98	240801	5	131	241314	5	19
239495	5	98	240802	5	131	241315	5	19
239496	5	98	240803	5	131	241316	5	19
239497	5	98	240804	5	131	241317	5	19
239500	5	98	240805	5	131	241318	5	19
239501	5	98	240806	5	131	241320	5	27
239502	5	98	240807	5	131	241321	5	27
239503	5	98	240811	5	132	241322	5	27
239504	5	98	240812	5	132	241323	5	27
239505	5	98	240813	5	132	241324	5	27
239506	5	98	240814	5	132	241325	5	27
239507	5	98	240815	5	132	241326	5	27
239510	5	91	240816	5	132	241327	5	27
239511	5	91	240817	5	132	241328	5	27
239512	5	91	241180	5	19	241340	5	21
239513	5	91	241181	5	19	241341	5	21
239514	5	91	241182	5	19	241342	5	21
239515	5	91	241183	5	19	241343	5	21
239516	5	91	241184	5	19	241344	5	21
239517	5	91	241185	5	19	241345	5	21
239520	5	91	241186	5	19	241346	5	21
239521	5	91	241187	5	19	241347	5	21
239522	5	91	241188	5	19	241348	5	21
239523	5	91	241190	5	27	241360	5	28
239524	5	91	241191	5	27	241361	5	28
239525	5	91	241192	5	27	241362	5	28
239526	5	91	241193	5	27	241363	5	28
239527	5	91	241194	5	27	241364	5	28
239730	5	105	241195	5	27	241365	5	28
239731	5	105	241196	5	27	241366	5	28
239732	5	105	241197	5	27	241367	5	28
239733	5	105	241198	5	27	241368	5	28
239734	5	105	241210	5	20	241380	5	23
239735	5	105	241211	5	20	241381	5	23
239736	5	105	241212	5	20	241382	5	23
239737	5	105	241213	5	20	241383	5	23
239740	5	105	241214	5	20	241384	5	23
239741	5	105	241215	5	20	241385	5	23
239742	5	105	241216	5	20	241386	5	23
239743	5	105	241217	5	20	241387	5	23
239744	5	105	241218	5	20	241388	5	23
239745	5	105	241224	5	22	241390	5	29
239746	5	105	241225	5	22	241391	5	29
239747	5	105	241226	5	22	241392	5	29
239750	5	98	241227	5	22	241393	5	29
239751	5	98	241228	5	22	241394	5	29
239752	5	98	241230	5	28	241395	5	29
239753	5	98	241231	5	28	241396	5	29
239754	5	98	241232	5	28	241397	5	29
239755	5	98	241233	5	28	241398	5	29
239756	5	98	241234	5	28	241410	5	24
239757	5	98	241235	5	28	241411	5	24
239760	5	98	241236	5	28	241412	5	24
239761	5	98	241237	5	28	241413	5	24
239762	5	98	241238	5	28	241414	5	24
239763	5	98	241250	5	22	241415	5	24
239764	5	98	241251	5	22	241416	5	24
239765	5	98	241252	5	22	241417	5	24
239766	5	98	241253	5	22	241418	5	24
239767	5	98	241254	5	22	241420	5	30
240260	5	92	241255	5	22	241421	5	30
240261	5	92	241256	5	22	241422	5	30
240262	5	92	241257	5	22	241423	5	30
240270	5	92	241258	5	22	241424	5	30
240271	5	92	241260	5	29	241425	5	30
240272	5	92	241261	5	29	241426	5	30
240281	5	124	241262	5	29	241427	5	30
240282	5	124	241263	5	29	241428	5	30
240283	5	124	241264	5	29	241440	5	20
240284	5	124	241265	5	29	241441	5	20
240285	5	124	241266	5	29	241442	5	20
240286	5	124	241267	5	29	241443	5	20





<b>№</b>		<b>Page</b>	<b>№</b>		<b>Page</b>	<b>№</b>		<b>Page</b>
241444	5	20	241642	5	31	241764	5	21
241445	5	20	241643	5	31	241765	5	21
241446	5	20	241644	5	31	241766	5	21
241447	5	20	241650	5	19	241767	5	21
241448	5	20	241651	5	19	241768	5	21
241450	5	28	241652	5	19	241780	5	23
241451	5	28	241653	5	19	241781	5	23
241452	5	28	241654	5	19	241782	5	23
241453	5	28	241655	5	19	241783	5	23
241454	5	28	241656	5	19	241784	5	23
241455	5	28	241657	5	19	241785	5	23
241456	5	28	241658	5	19	241786	5	23
241457	5	28	241660	5	20	241787	5	23
241458	5	28	241661	5	20	241788	5	23
241470	5	21	241662	5	20	241790	5	25
241471	5	21	241663	5	20	241791	5	25
241472	5	21	241664	5	20	241792	5	25
241473	5	21	241665	5	20	241793	5	25
241474	5	21	241666	5	20	241794	5	25
241475	5	21	241667	5	20	241795	5	25
241476	5	21	241668	5	20	241796	5	25
241477	5	21	241670	5	22	241797	5	25
241478	5	21	241672	5	22	241798	5	25
241490	5	29	241674	5	22	241800	5	25
241491	5	29	241675	5	22	241801	5	25
241492	5	29	241676	5	22	241802	5	25
241493	5	29	241677	5	22	241803	5	25
241494	5	29	241678	5	22	241804	5	25
241495	5	29	241680	5	22	241810	5	26
241496	5	29	241681	5	22	241811	5	26
241497	5	29	241682	5	22	241812	5	26
241498	5	29	241683	5	22	241813	5	26
241510	5	23	241684	5	22	241814	5	26
241511	5	23	241685	5	22	241820	5	26
241512	5	23	241686	5	22	241821	5	26
241513	5	23	241687	5	22	241822	5	26
241514	5	23	241688	5	22	241823	5	26
241515	5	23	241690	5	24	241824	5	26
241516	5	23	241691	5	24	241850	10	146
241517	5	23	241692	5	24	241852	10	146
241518	5	23	241693	5	24	241854	10	146
241520	5	30	241694	5	24	241860	10	146
241521	5	30	241695	5	24	241862	10	146
241522	5	30	241696	5	24	241864	10	146
241523	5	30	241697	5	24	241931	5	123
241524	5	30	241698	5	24	241932	5	123
241525	5	30	241700	5	19	241933	5	123
241526	5	30	241701	5	19	241934	5	123
241527	5	30	241702	5	19	241935	5	123
241528	5	30	241703	5	19	241936	5	123
241540	5	25	241704	5	19	241937	5	123
241541	5	25	241705	5	19	241940	5	119
241542	5	25	241706	5	19	241941	5	119
241543	5	25	241707	5	19	241942	5	119
241544	5	25	241708	5	19	241943	5	119
241545	5	25	241710	5	21	241944	5	119
241546	5	25	241711	5	21	241945	5	119
241547	5	25	241712	5	21	241946	5	119
241548	5	25	241713	5	21	241947	5	119
241550	5	31	241714	5	21	242090	5	87
241551	5	31	241715	5	21	242091	5	87
241552	5	31	241716	5	21	242092	5	87
241553	5	31	241717	5	21	242093	5	87
241554	5	31	241718	5	21	242094	5	87
241555	5	31	241730	5	23	242100	5	87
241556	5	31	241731	5	23	242101	5	87
241557	5	31	241732	5	23	242102	5	87
241558	5	31	241733	5	23	242103	5	87
241570	5	25	241734	5	23	242104	5	87
241571	5	25	241735	5	23	242110	5	87
241572	5	25	241736	5	23	242111	5	87
241573	5	25	241737	5	23	242112	5	87
241574	5	25	241738	5	23	242113	5	87
241580	5	31	241740	5	24	242114	5	87
241581	5	31	241741	5	24	242120	5	87
241582	5	31	241742	5	24	242121	5	87
241583	5	31	241743	5	24	242122	5	87
241584	5	31	241744	5	24	242123	5	87
241600	5	26	241745	5	24	242124	5	87
241601	5	26	241746	5	24	242130	5	99
241602	5	26	241747	5	24	242131	5	99
241603	5	26	241748	5	24	242132	5	99
241604	5	26	241750	5	20	242133	5	99
241610	5	31	241751	5	20	242134	5	99
241611	5	31	241752	5	20	242140	5	99
241612	5	31	241753	5	20	242141	5	99
241613	5	31	241754	5	20	242142	5	99
241614	5	31	241755	5	20	242143	5	99
241630	5	26	241756	5	20	242144	5	99
241631	5	26	241757	5	20	242150	5	99
241632	5	26	241758	5	20	242151	5	99
241633	5	26	241760	5	21	242152	5	99
241634	5	26	241761	5	21	242153	5	99
241640	5	31	241762	5	21	242154	5	99
241641	5	31	241763	5	21	242160	5	99



<b>№</b>		<b>Page</b>	<b>№</b>		<b>Page</b>	<b>№</b>		<b>Page</b>
242161	5	99	242403	5	140	244363	5	138
242162	5	99	242411	5	139	244371	5	138
242163	5	99	242413	5	139	244373	5	138
242164	5	99	242421	5	139	244381	5	143
242170	5	100	242423	5	139	244383	5	143
242171	5	100	242450	10	146	244391	5	143
242172	5	100	242452	10	146	244393	5	143
242173	5	100	242454	10	146	244580	5	22
242174	5	100	242470	5	92	244582	5	22
242180	5	100	242471	5	92	244590	5	22
242181	5	100	242472	5	92	244592	5	22
242182	5	100	242473	5	92	244600	5	85
242183	5	100	242474	5	92	244602	5	85
242184	5	100	242480	5	92	244610	5	97
242190	5	99	242481	5	92	244612	5	97
242191	5	99	242482	5	92	244620	5	104
242192	5	99	242483	5	92	244622	5	104
242193	5	99	242484	5	92	244740	5	19
242194	5	99	242720	5	86	244742	5	19
242200	5	99	242721	5	86	26617	20	163
242201	5	99	242722	5	86	26755	100	164
242202	5	99	242723	5	86	26799	20	156
242203	5	99	242724	5	86	28603	1	216
242204	5	99	242730	5	86	29776	50	154
242210	5	105	242731	5	86	29787	50	157,165
242211	5	105	242732	5	86	29788	20	158
242212	5	105	242733	5	86	<b>3</b>		
242213	5	105	242734	5	86	30545	200	154
242214	5	105	242740	5	87	34004	50	157
242220	5	105	242741	5	87	34606	200	170
242221	5	105	242742	5	87	34610	200	170
242222	5	105	242743	5	87	34934	200	167
242223	5	105	242744	5	87	34943	200	162
242224	5	105	242750	5	87	34969	200	162
242230	5	106	242751	5	87	34979	200	162
242231	5	106	242752	5	87	34980	200	162
242232	5	106	242753	5	87	34981	200	165
242233	5	106	242754	5	87	35250	50	170
242234	5	106	242780	5	25	354358	100	211
242240	5	106	242781	5	25	354952	20	154
242241	5	106	242782	5	25	354954	20	154
242242	5	106	242783	5	25	354987	20	170
242243	5	106	242784	5	25	355000	20	170
242244	5	106	242790	5	25	357671	200	159
242250	5	106	242791	5	25	357672	200	159
242251	5	106	242792	5	25	357673	100	159
242252	5	106	242793	5	25	357674	100	159
242253	5	106	242800	5	26	358024	50	212
242254	5	106	242801	5	26	360074	100	211
242260	5	106	242802	5	26	360102	100	159
242261	5	106	242803	5	26	360103	100	159
242262	5	106	242804	5	26	360112	20	154
242263	5	106	242810	5	26	360113	20	154
242264	5	106	242811	5	26	360159	20	211
242270	5	106	242812	5	26	360397	50	212
242271	5	106	242813	5	26	360614	20	159
242272	5	106	242814	5	26	360615	20	159
242273	5	106	242820	5	27	362002	20	155,158
242274	5	106	242821	5	27	362704	100	212
242280	5	106	242822	5	27	362906	50	213
242281	5	106	242823	5	27	362920	100	211
242282	5	106	242824	5	27	363322	20	155,157
242283	5	106	242830	5	27	363473	1	204
242284	5	106	242831	5	27	363959	100	212
242290	5	86	242832	5	27	364326	100	212
242291	5	86	242833	5	27	364770	20	212
242292	5	86	242834	5	27	364771	20	212
242293	5	86	243570	10	147	364952	100	167
242294	5	86	243572	10	147	364953	100	167
242300	5	86	243574	10	147	367701	1	205
242301	5	86	243580	10	147	367702	1	205
242302	5	86	243582	10	147	369143	50	213
242303	5	86	243584	10	147	369691	100	211
242304	5	86	243590	10	147	38924	50	163
242310	5	105	243592	10	147	<b>4</b>		
242311	5	105	243594	10	147	40720	20	212
242312	5	105	243601	5	142	43524	50	212
242313	5	105	243611	5	141	43586	50	213
242314	5	105	243613	5	141	43718	100	211
242320	5	105	243631	5	141	44205	100	211
242321	5	105	243641	5	141	44206	100	211
242322	5	105	243643	5	141	44253	50	211
242323	5	105	243680	5	136	44268	100	211
242324	5	105	243681	5	136	44316	100	211
242351	5	138	243682	5	136	44372	50	211
242353	5	138	243683	5	136	44373	50	211
242361	5	138	243684	5	136	458274	1	204
242363	5	138	243690	5	136	466699	1	205
242371	5	139	243691	5	136	466833	1	204
242373	5	139	243692	5	136	466834	1	204
242381	5	139	243693	5	136	466835	1	204
242383	5	139	243694	5	136	466836	1	204
242391	5	140	244111	5	138	466837	1	204
242393	5	140	244113	5	138			
242401	5	140	244361	5	138			



<b>№</b>		<b>Page</b>	<b>№</b>		<b>Page</b>	<b>№</b>		<b>Page</b>
466838	1	204	55217	10	209	96845	100	157
466842	1	204	55252	50	163	96846	100	157
473398	1	195	55395	5	151	96861	100	165
473399	1	195	55396	5	151			
473400	1	195	55397	5	151			
473411	1	192	55398	5	151			
473412	1	192	55399	5	151			
473413	1	192	55484	5	151			
473414	1	192	55485	5	151			
473415	1	192	55486	5	151			
473416	1	192	55487	5	151			
473417	1	192	55488	10	209			
473418	1	192	55489	10	209			
473419	1	192	55490	10	209			
473420	1	192	55491	10	209			
473421	1	192	55985	20	188,188,189			
473422	1	192	55986	20	163			
473423	1	192	55987	50	162			
473424	1	196	55989	20	188,188,189			
473425	1	196	55992	10	199			
473426	1	196	55993	10	198			
473427	1	196	57179	5	151			
473428	5	196	57181	5	151			
473605	1	196	57824	10	198			
473606	1	194	57825	10	198			
473607	1	194	57826	10	198			
473608	1	194	57827	10	198			
473609	1	194	57915	20	190			
473610	1	194	57916	20	190			
473611	1	196	58029	20	190			
473837	1	192	58030	20	190			
473838	1	192	58107	10	199			
473839	1	192	58188	5	151			
473840	1	196	58191	10	201			
473905	1	192	58329	10	199			
473906	1	192	58330	10	199			
473907	1	194	58331	10	199			
473908	1	194	58333	10	199			
473909	1	194	58335	10	201,202			
473910	1	196	58458	10	199			
473915	1	196	58463	20	188			
473923	1	192	58464	20	188,188,189			
473924	1	192	58465	20	190			
473925	1	192	58467	20	188			
473926	1	192	58468	20	188,188,189			
473927	1	192	58469	20	190			
473928	1	192	58574	20	189			
473929	1	192	58575	20	189			
473930	1	192	58608	20	189			
473931	1	192	58609	20	189			
473932	1	192	58646	50	162			
473933	1	192	58647	50	162			
473934	1	192	58648	20	162			
473935	1	192	58649	20	162			
473936	1	192	58667	20	163			
473937	1	192	59391	5	152			
473938	1	192	59405	10	199			
473939	1	192	59420	10	154			
473940	1	192	59421	50	154			
473941	1	192	59422	20	188			
473942	1	192	59423	20	188			
473943	1	193	59424	20	188			
473944	1	193	59425	20	188			
473945	1	195	59426	20	189			
473946	1	195	59427	20	189			
473947	1	195	59428	20	189			
473948	1	194	59429	20	189			
473949	1	194	59430	20	189			
473950	1	194	59431	20	189			
476036	1	192	59433	20	190			
476044	1	196	59900	5	151			
476045	1	196	59901	5	151			
476047	1	192						
476048	1	192						
476049	1	192						
476050	1	192						
476513	1	205						
476514	1	205						
476515	1	205						
<b>5</b>			<b>7</b>					
50576	20	156	757154		216			
50579	20	163	757155		216			
55049	20	185	757156		216			
55112	100	156	757157		216			
55146	5	152	757158		216			
55147	5	152	757159		216			
55148	5	152						
55149	5	152						
55169	10	209						
55170	10	209						
55171	10	209						
55172	10	209						
55215	10	209						
55216	10	209						
			<b>9</b>					
			94019	10	212			
			94118	50	155			
			94219	100	212			
			94322	50	163			
			96263	100	162			
			96264	100	162			
			96305	100	155			
			96306	100	155			
			96558	100	170			
			96561	100	165			
			96565	100	155			
			96566	100	155			
			96660	100	162			

**MACO  
PROTECT**



**MAYER & CO  
BESCHLÄGE GMBH**  
Alpenstraße 173  
A-5020 Salzburg

Tel.: +43 662 6196-0  
E-Mail: [maco@maco.eu](mailto:maco@maco.eu)  
[www.maco.eu](http://www.maco.eu)



### **Satisfied?**

We appreciate your  
[feedback@maco.eu](mailto:feedback@maco.eu)

Order.-No. 49689EN – Date: January 2017  
All rights reserved and subject to change.

This print document is revised regularly.  
The latest version is available at  
<http://www.maco.eu/sites/assets/MacoDocs/49689/49689en.pdf>  
or scan the QR code.

