



myRoom™

Guestroom systems for light,
temperature, and shade control



Palladiom™ keypad



Palladiom thermostat

What is myRoom™?

Lutron myRoom is a family of guestroom systems for light, temperature, and shade control. Each system can be tailored to specific performance and budget requirements.

All myRoom systems offer beautiful, energy-efficient, affordable control options that will help differentiate your property and delight your guests.

- Globally available product and service capabilities ensure consistency in properties around the world
 - Supported by more than 50 years of Lutron Innovation, Quality, and Service
 - **Two product tiers**—myRoom prime and myRoom plus—offer solutions for every property
 - **Guest presence detection**—myRoom systems use a combination of occupancy sensing, door open/close, and keypad button press information to determine guest presence
-

Table of Contents

Guest Benefits	2
Property Benefits	3
myRoom prime	5
myRoom plus	11
System Comparison	16
Lutron Controls	18
Lutron Controls—Colors and Finishes	20
Why Lutron?	22
Additional Resources	24



myRoom **prime**

- Light, temperature, and shade control independent of hotel management systems
- Delivers energy savings from reduced lighting and HVAC usage
- Uses room occupied/unoccupied information for guest presence detection

myRoom **plus**

- Light, temperature, and shade control that integrates with property management systems (PMS) and building management systems (BMS)
- Increased energy savings realized from automatic lighting and HVAC adjustments, and enhanced by shade control
- Uses room occupied/unoccupied and sold/unsold information for guest presence detection and additional HVAC setbacks

myRoom™ Benefits

Guest Benefits

Create a comfortable, inviting environment that allows guests to appreciate their home away from home.

Intuitive elegance

- Large buttons are easy-to-use and feature tactile, audible feedback
- Dynamic backlighting in Palladiom™ controls adjusts based on scene or time-of-day programming to enhance guest comfort
- Bedside keypads provide convenient control
- Same in-room experience anywhere in the world

Featured product — Palladiom keypads

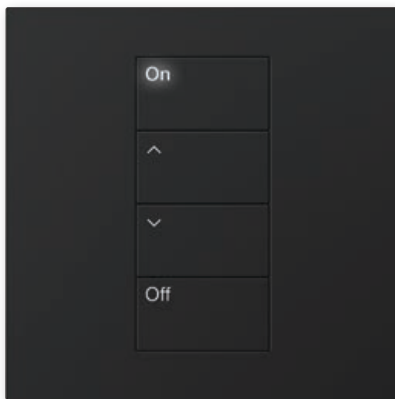

Shown in Black with standard engraving



Shown in Satin Nickel with customized Spanish engraving



Shown in Clear Glass White with customized engraving

Comfort and privacy

- Convenient, automated control of shades/drapes at guest's fingertips
- Ultra-quiet motors and smooth performance enhance the guest experience
- Provide privacy, reduce glare, or block daylight

Energy efficiency

- Energy-saving controls promote environmental responsibility while enhancing guest comfort
- Guest presence detection ensures automated, unobtrusive control

Property Benefits

Save energy, reduce operating costs, and continue to delight your guests

All-in-one solution

- Single-provider control of lighting, temperature, and shades ensures seamless integration
- Lutron offers solutions for the entire property — from guest rooms to public areas and back-of-house
- Lutron products and services deliver a uniform, global experience before, during, and after project installation

Featured products

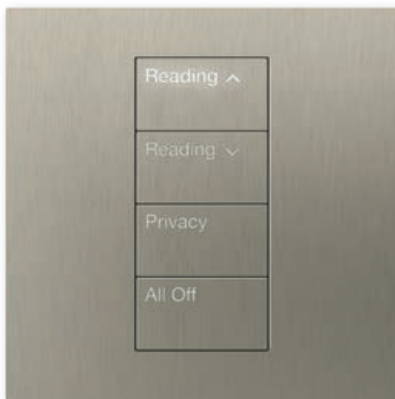

Palladiom keypad shown in Satin Nickel



Palladiom thermostat shown in Satin Nickel



Alena™ drapery track

Offers integration with other hotel systems

- myRoom™ plus enables integration with BMS, PMS, and third-party concierge systems
- Utilizes Lutron's extensive experience with commercial and residential systems integration

Save energy and reduce costs

- myRoom systems automatically reduce both lighting and HVAC energy use in response to room vacancy or occupancy conditions
- Integrated shade controls further increase HVAC savings by minimizing solar heat gain
- Promotes operational efficiency — provides the ability to know when the guest has requested service or privacy
- Lutron has partnered with HVAC industry experts to ensure trouble-free installation



Marriott Hotel, Frankfurt, Germany



myRoom™ prime

A guestroom system for light, temperature, and shade control **independent of hotel management systems**

Select the system components

- Every myRoom prime system starts with lighting control that can respond to guest presence detection
- Complete the system with temperature control and Alena™ drapery track solutions

Keypads



Pico® wireless control for lights or shades



Palladiom™ QS for lights or shades*



Thermostats



230V~ model†



Palladiom QS*

Draperies



- Alena drapery track
- Alena QS drapery track*
- Alena QS wireless drapery track

Base system components



Wireless access point



Occupancy sensors

- Ceiling-mount, wireless
- Wall-mount, wireless
- Ceiling-mount, wired
- Wall-mount, wired
- Door contact (third-party)



Load controls

- 1 A switch
- 1 A phase adaptive dimmer
- Receptacle control (with third-party contactor)

Example 1: Lights

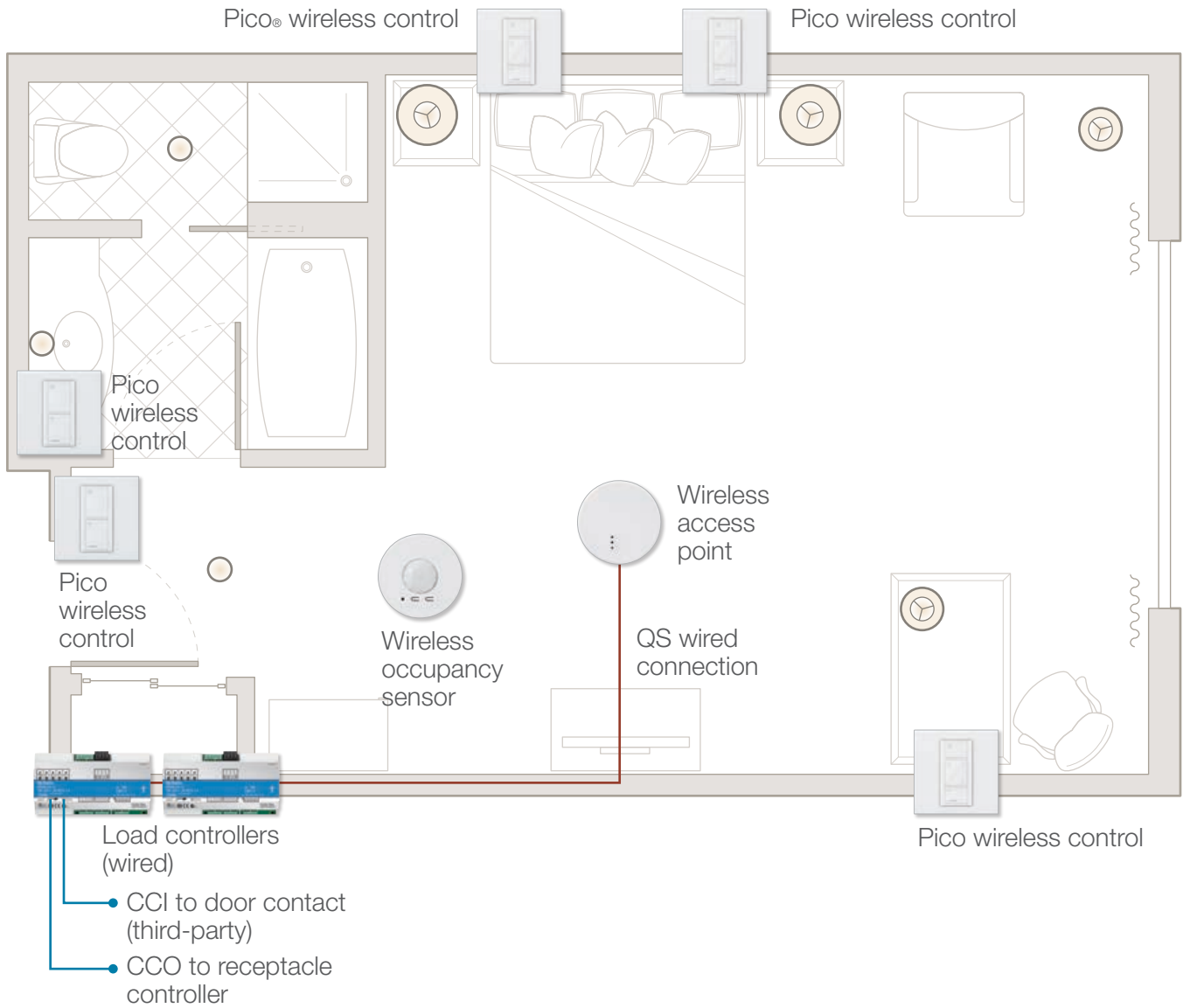

Sequence of operations

	Occupied	Unoccupied	Manual control
Lights	Welcome scene	Off	Zone control, zone toggle, scene control
Receptacles (optional)	Powered	Off	Not applicable

Example 2: Lights and temperature

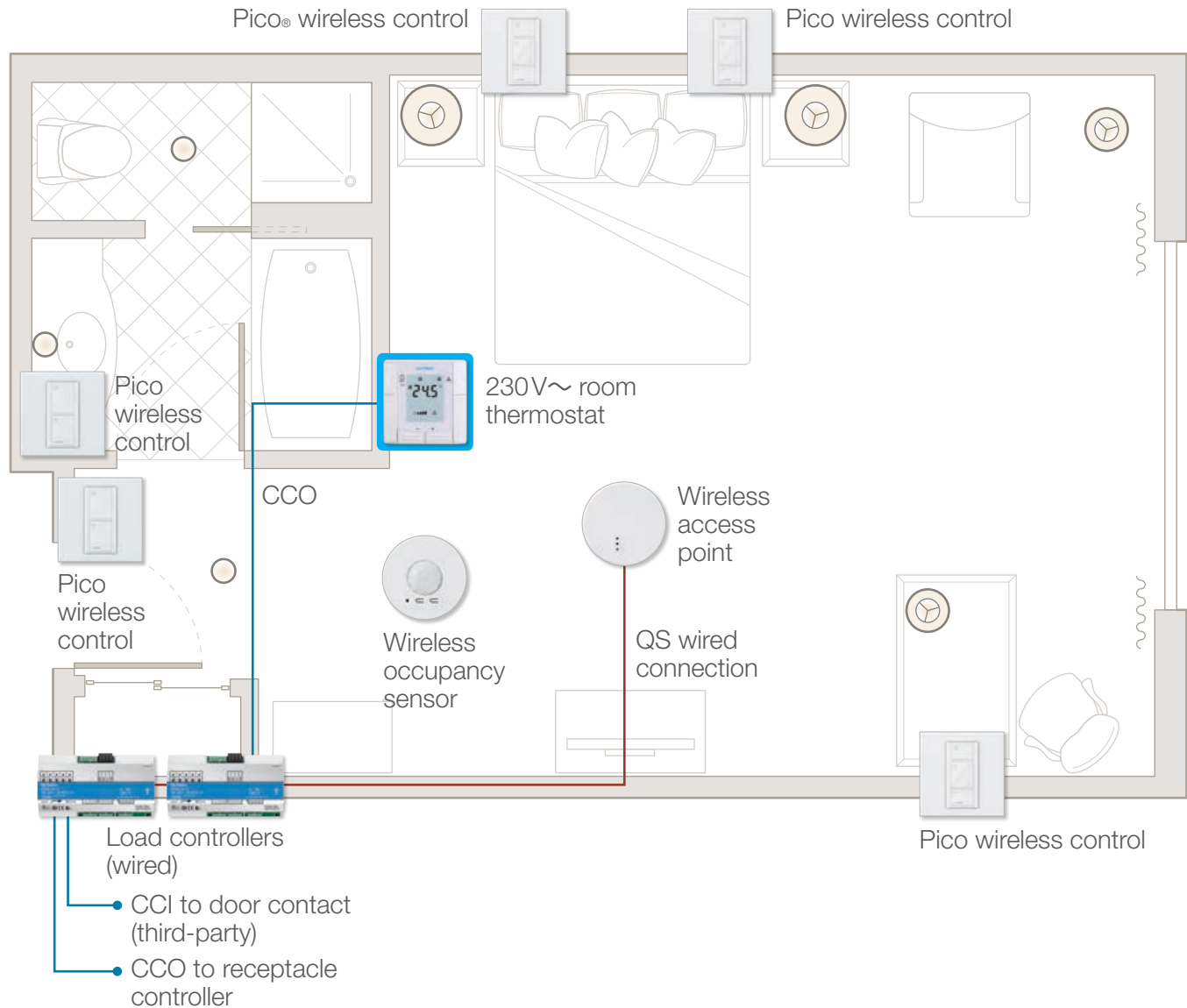

Sequence of operations

	Occupied	Unoccupied	Manual control
Lights	Welcome scene	Off	Zone control, zone toggle, scene control
Receptacles (optional)	Powered	Off	Not applicable
Temperature	Comfort mode: guest controlled setpoint, small drift	Setback mode: drift to hotel's energy-saving setpoints	Guest controlled setpoint

Example 3: Lights, temperature, and shades

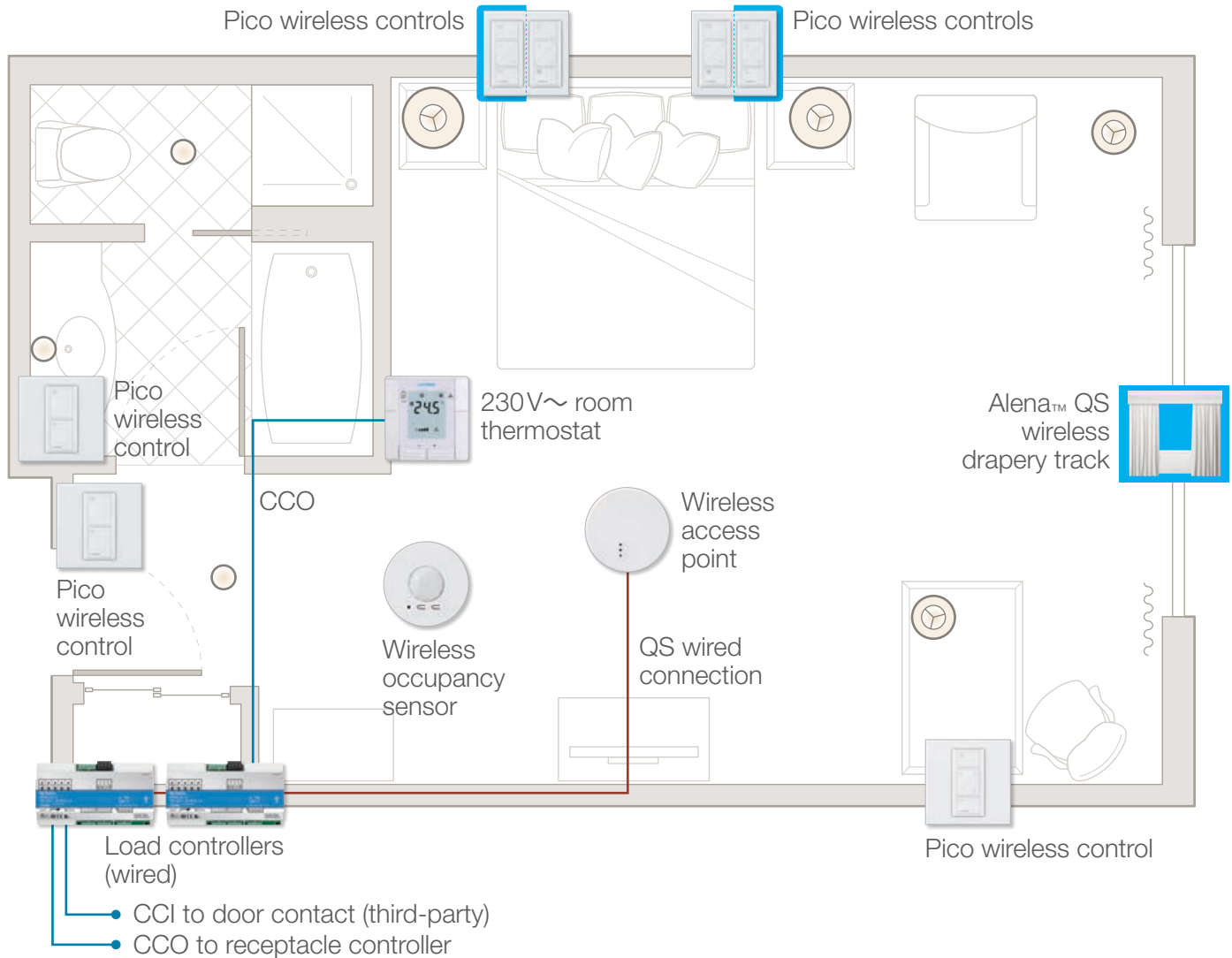

Sequence of operations

	Occupied	Unoccupied	Manual control
Lights	Welcome Scene	Off	Zone control, zone toggle, scene control
Receptacles (optional)	Powered	Off	Not applicable
Temperature	Comfort mode: guest controlled setpoint, small drift	Setback mode: drift to hotel's energy-saving setpoints	Guest controlled setpoint
Draperies	Unaffected	Unaffected	Open, close, preset, and manual pull-to-start



Park Hyatt, Shanghai, China



myRoom™ plus

A guestroom management system for light, temperature, and shade control that **integrates with property and building management systems**

Select the system components

- Every myRoom plus system is programmed with a guestroom control unit that responds to guest presence detection and facilitates integration with third-party systems
- Complete the system with the right mix of light, temperature, and shade controls

Keypads



Pico® wireless control for lights or shades



Privacy Pico



Corridor Pico



Palladiom™ QS for lights or shades



seeTouch® QS (insert, non-insert, and RF models available)



Signature Series™



Architrave™

Thermostats



230V~ model*



Palladiom QS

Note: Not all styles and finishes are available in all regions.

Shades/draperies



- Alena™ drapery track
- Alena QS drapery track
- Alena QS wireless drapery track
- Sivoia® QS roller shades
- Sivoia QS Roman shades
- Sivoia QS Venetian blinds
- Sivoia QS Kirbé® vertical drapery
- Sivoia QS tensioned shades

Base system components



Room controllers

- Guestroom control unit
- Wireless repeater



Integration

- Property Management System
- Building Management System
- Contact closure
- Concierge system



Wireless access point



Occupancy sensors

- Ceiling-mount, wireless
- Wall-mount, wireless
- Ceiling-mount, wired
- Wall-mount, wired
- Door contact (third party)



Load controls

- 1 A switch
- 10 A switch
- 1 A phase adaptive dimmer
- 2 A phase adaptive dimmer
- Receptacle control (with third-party contactor)

- DALI
- EcoSystem®
- 0–10V
- DMX interface
- GRAFIK Eye® QS

Example: Lights, temperature, and shades with integration

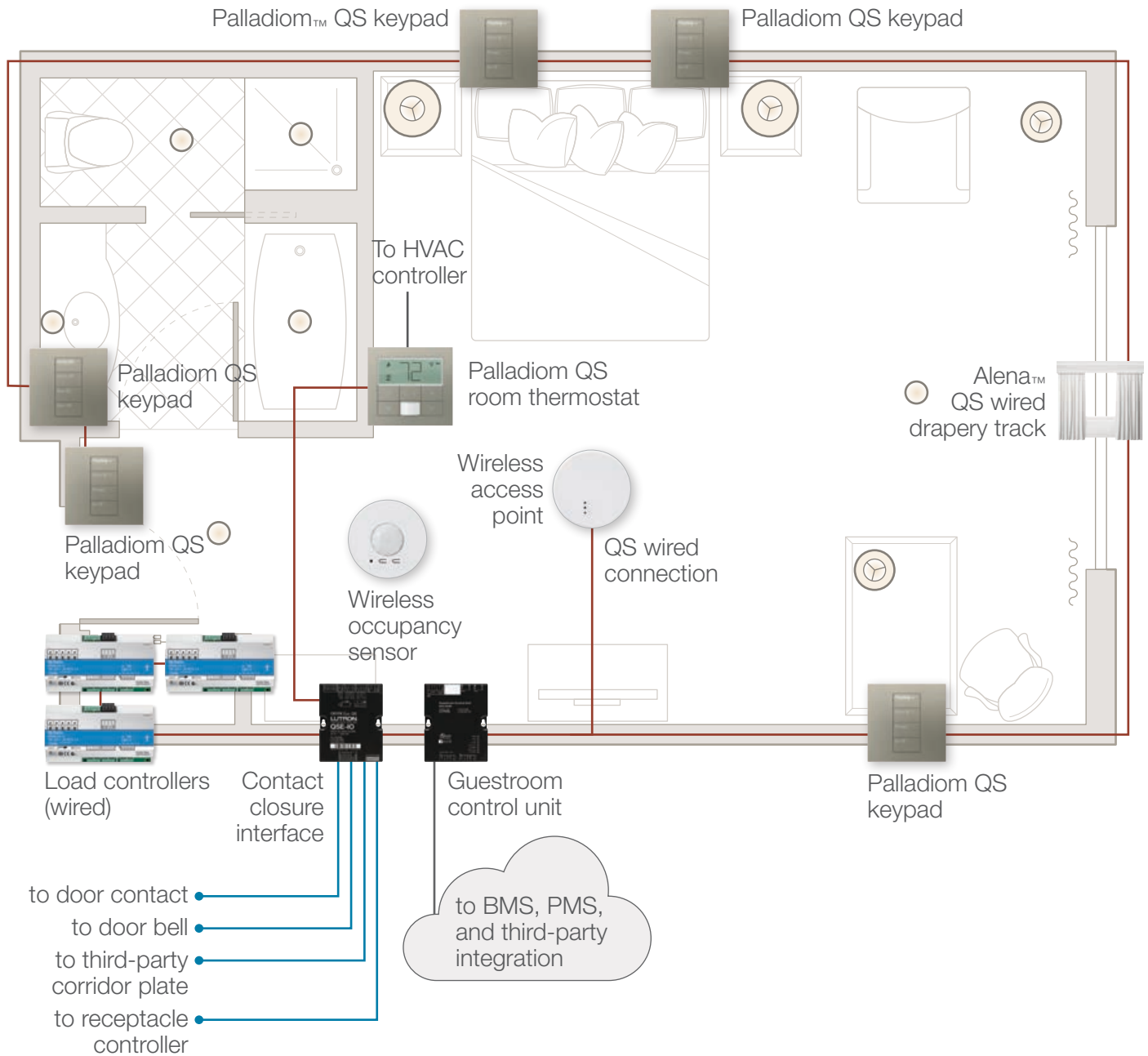

Sequence of operations

	Unsold Check-out	Sold Check-in	Sold Occupied Day		Sold Occupied Night		Sold Unoccupied
Lights	Off	Off	First entry	Other entry	First entry	Other entry	Off
			Day grand-welcome scene	Day welcome scene	Night grand-welcome scene	Night welcome scene	
Receptacles (optional)	Off	Off	Powered		Powered		Off
Temperature	Deep Setback: hotel setpoint, large drift	Comfort Mode: hotel setpoint, small drift	Comfort Mode: guest controlled, small drift		Comfort Mode: guest controlled, small drift		Setback Mode: guest controlled, medium drift
Shades/ Draperies	Closed	Closed	First entry	Other entry	First entry	Other entry	N/A
			Open	Unaffected	Closed	Unaffected	

System Comparison

Components

		myRoom™ prime	myRoom plus
Load types	Switched	✓	✓
	Phase adaptive dimming	✓	✓
	0–10V	✓ ¹	✓
	EcoSystem®	-	✓
	DALI	-	✓
	DMX	-	✓
Keypads	Pico® wireless control	✓	✓
	Palladiom™ QS	✓ ²	✓
	seeTouch®	-	✓
	Architrave™	-	✓
	Signature Series™	-	✓
Thermostats	230V~ model ³	✓	✓
	Palladiom QS	✓ ²	✓
Dynamic backlight programming	Adjustable at programming	✓ ²	✓
	Dynamic during usage ⁴ (time of day, button press)	-	✓
Shades/draperies	Alena™ drapery track solutions	✓	✓
	Sivoia® QS roller shades, Roman shades, and all other Sivoia QS shade styles	-	✓

Advanced Features

		myRoom prime	myRoom plus
Energy saving statuses	Occupied/Unoccupied	✓	✓
	Sold/Unsold	-	✓
Welcome scene options	Default guest welcome scene	✓	✓
	Doorlock integrated programmable welcome scenes ⁵	-	✓
Privacy/service	Privacy and corridor Pico controls	-	✓
	Third-party corridor plate	-	✓
Integration	PMS integration for guest check-in and privacy/service information	-	✓
	BMS BACnet/IP integration for lights, shades and temperature control	-	✓

1 With GRX-TVI interface

2 Available late 2015

3 120V~ requires third-party thermostat with contact closure input









4 With Palladiom QS products only

5 Allows for multiple welcome scenes (guest first entry, guest subsequent entry, staff entry) that respond to programmed doorlock integration. Available for use with qualified partners.

Lutron Controls

Controls are available in a variety of styles for both wired and wireless installations.









Keypads

Name	Pico®	seeTouch® (insert)	seeTouch (non-insert)
Communication	Wired and wireless*	Wired and wireless	Wired and wireless
Plastic			
Glass			
Metal			

*Wire-free installation

Note: Square and rectangle styles available. Custom engraving available for Lutron keypads. Ask your Lutron representative for details.

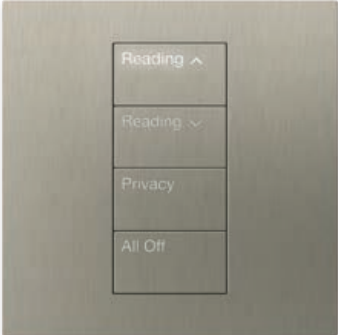
Thermostats

Palladiom™ QS	230V~ model	Palladiom QS
Wired only	Wired only	Wired only
		
		
		

Lutron Controls—Colors and Finishes

Lutron controls come in a wide variety of colors and finishes to coordinate with your project style and aesthetic.

Gloss

White WH	Ivory IV	Almond AL	Light Almond LA
Grey GR	Brown BR	Black BL	Stainless Steel SS

Satin Colors®

Hot HT	Merlot MR	Plum PL	Turquoise TQ
Terracotta TC	Greenbriar GB	Bluestone BG	Mocha Stone MS
Sea Glass SG	Taupe TP	Eggshell ES	Biscuit BI
Goldstone GS	Desert Stone DS	Stone ST	Limestone LS
Snow SW	Palladium PD	Midnight MN	Sienna SI

Note: Products with Gloss, Satin Colors, Architectural Matte, and Architectural Metallic finishes are made of plastic.

Architectural Matte

White WH	Arctic White AW	Beige BE	Ivory IV
Almond AL	Light Almond LA	Grey GR	Taupe TP
Brown BR	Black BL	Sienna SI	

Architectural Metal

Satin Brass SB	Bright Brass BB	Bright Chrome BC	Satin Nickel SN
Bright Nickel BN	Satin Chrome SC	Antique Brass QB	Antique Bronze QZ
Gold Plated AU	Clear Anodized Aluminum CLA	Black Anodized Aluminum BLA	Brass Anodized Aluminum BRA

Architectural Metallic

Argentum AR

Mica MC

Glass

Clear Glass CWH

Green Glass GWH

Note: Not all products, colors, and finishes are available in all regions. For more information on myRoom™ systems, talk to your Lutron representative.

Why Lutron?

At Lutron, our first principle is also our customer promise —
Take care of the customer with superior goods and services

The Lutron Advantage

Lutron is the global leader in lighting and shade control, offering our customers more than 50 years of unrivaled innovation, world class quality, and outstanding service

- Every product is end-of-line tested before it is shipped
- Long battery life — our battery-operated sensors and remote controls feature a 10-year battery life
- Field analysis, post-occupancy evaluations, and rigorous supplier quality audits help ensure customer satisfaction
- Global service and technical support — wherever and whenever you need us



A global experience

Lutron sales and service offices are located across the globe to best serve all our customers.

- 24/7 live support by trained Lutron technical professionals and engineers — U.S. based for the Americas, regionally based for Europe, Asia, Africa and Australia
- Global voltages and frequencies
- Commercial project management teams are available for every market



Additional Resources

Digital Tools

Lutron design, selection, and analytical tools can help make choosing your products easier.



LED Control Center of Excellence

Information on how to correctly specify, install, and use LEDs—www.lutron.com/leds



Lutron Fabric Collections App for iPad®

Browse Lutron shade options and the entire fabric collection; zoom in on fabric swatches to see greater detail, and order samples right from your mobile device.



Lutron Commercial and Pleasance Apps

Apps provide a portal to all the information needed to specify and install Lutron light, temperature, and shade control solutions.



Quantum Vue™

This web-based facility management tool provides full-system monitoring of lighting and shade control from any device.

Lutron Product Literature

For more information about Lutron lighting and shade controls, visit www.lutron.com, and look for these solution brochures.



Hospitality Solutions Brochure

Browse through lighting and shade control solutions for every type of hospitality space. PN: 367-2425



Quantum® Total Light Management™ Brochure

Control all the lighting, temperature, and shades in your building, or across your campus, with Lutron total light management solutions. PN: 367-1321



Palladiom™ Brochure

A guide to Lutron's newest keypads. PN: 367-2552



Essence of Pleasance Brochure

See how Lutron solutions can add the fundamental feeling of pleasance to any property. PN: 367-2324



Palladiom Thermostat Brochure

A guide to Lutron's newest temperature controls. PN: 367-2553

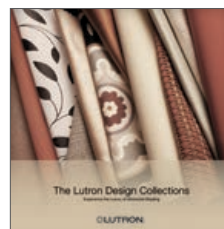

Lutron Design Collection Fabric Selection Guide

Experience the luxury of motorized shading. Lutron Design Collections have solutions to suit every style and complement every project. PN: 367-2456



Daylight Autonomy Brochure

See how automated shading solutions with daylighting controls can save energy, enhance productivity, and improve the visual environment. PN: 367-2464



Energi TriPak® Brochure

Lutron wireless energy saving solutions offer affordable retrofit control. PN: 367-2110

Locations

World Headquarters

Lutron Electronics Co., Inc.
7200 Suter Road
Coopersburg, PA 18036-1299
U.S.A.
Toll-free: 1.888.LUTRON1
TEL: +1.610.282.3800
FAX: +1.610.282.1243
intsales@lutron.com

Regional Headquarters

Asia: Singapore

Lutron GL Ltd.
TEL: +65.6220.4666
lutronsea@lutron.com

Europe: London, UK

Lutron EA Ltd.
FREEPHONE: 0800.282.107
TEL: +44.207.702.0657
lutronlondon@lutron.com

India: Gurgaon (New Delhi)

Lutron GL Sales and Services Pvt. Ltd.
TEL: +91.124.471.1900
lutronindia@lutron.com

Latin America: Chihuahua, Mexico

Lutron CN S de RL de CV
TEL: +52.614.158.3435
lutronlatam@lutron.com

Middle East: Dubai, UAE

Lutron GL Ltd. Dubai Branch
TEL: +971.4.299.1224
lutronme@lutron.com

South America: São Paulo, Brazil

Lutron BZ do Brasil Ltda
TEL: +55.11.3257.6745
sacbrasil@lutron.com

International Offices

China: Beijing

TEL: +86.10.5925.1340

China: Guangzhou

TEL: +86.20.2885.8812

China: Hong Kong

TEL: +852.2104.7733

China: Shanghai

TEL: +86.21.6165.0990

Colombia: Bogotá

TEL: +57.1.467.2760

France: Paris

TEL: +33.156.591.664

Germany: Berlin

TEL: +49.309.710.4590

India: Bangalore

TEL: +91.80.4030.0485

India: Gurgaon

TEL: +91.124.439.0130

India: Mumbai

TEL: +91.22.4070.0867

Italy: Milan

TEL: +39.800.979.208

Japan: Tokyo

TEL: +81.3.6866.8444

Russia: Moscow

TEL: +7.495.649.6094

Saudi Arabia: Riyadh

TEL: +966.1.462.8000

South Africa: Johannesburg

TEL: +27.(0).83.731.0066

Spain: Barcelona

TEL: +34.93.222.1180

www.lutron.com/hospitality

Lutron Electronics Co., Inc. 7200 Suter Road Coopersburg, PA 18036-1299
World Headquarters 1.610.282.3800 | 24/7 Technical Support 1.800.523.9466 | Customer Service 1.888.LUTRON1 (1.888.588.7661)

© 01/2015 Lutron Electronics Co., Inc. | P/N 367-2551 REV A



LEED

