

Hardware system for sliding doors weighing up to 40 kg (88 lbs.) For low headroom applications.

Description

The HAWA-Junior 40/B is a hardware system with top fixed suspension for low headroom applications and for sliding doors with a weight of up to 40 kg (88 lbs.).









Features of the HAWA-Junior 40/B

- Top fixed suspension
- Low headroom applications
- Light and silent action
- Adjustable vertically ± 3 mm ($\frac{1}{8}$ ")
- Track stop, adjustable retaining force







Set for single door, without top track

| | code |
|---|-------|
| HAWA-Junior 40/B | 19475 |
| For two-panel sliding doors please order two sets for single doors. | |

Set comprising

| | | pieces | code |
|---|---|--------|-------|
|  | Two-wheeled trolley, M8, with plastic wheels | 2 | 10420 |
|  | Top fixed suspension with plate and hanger bolt M8, frontal attachment | 2 | 19631 |
|  | Cover cap for suspension profile, plastic anthracite-grey RAL 7016 | 2 | 21520 |
|  | Track stop, adjustable retaining force | 1 | 10640 |
|  | Screw-on rubber door stop | 1 | 10629 |
|  | Guide, rattle proof, for screw mounting to floor, groove width 10 mm ($\frac{3}{8}$ "), black plastic | 1 | 14427 |
|  | Suspension assembly locking wrench | 1 | 10793 |
|  | Hex key, 4 mm ($\frac{5}{32}$ "), length 160 mm ($6\frac{5}{16}$ ") | 1 | 19931 |

Accessories

| Caution: Minor differences in colour are possible | | code |
|---|---|-------|
|  | Guide profile, plastic black, 1300 mm ($4'3\frac{3}{16}$ "), groove mounted, set of 10 pieces | 14540 |
|  | Cover cap for top track, plastic anthracite-grey RAL 7016 | 20901 |
|  | dull chromium finish | 20773 |
| | stainless steel effect | 21473 |
|  | Two-wheeled trolley, M8, with plastic wheels, set of 10 pieces | 25963 |
|  | Track stop, adjustable retaining force, set of 10 pieces | 25957 |
|  | Guide, rattle proof, for screw mounting to floor, groove width 10 mm ($\frac{3}{8}$ "), black plastic, set of 10 pieces | 25958 |
| Further accessories: → pages 68–83 | | |

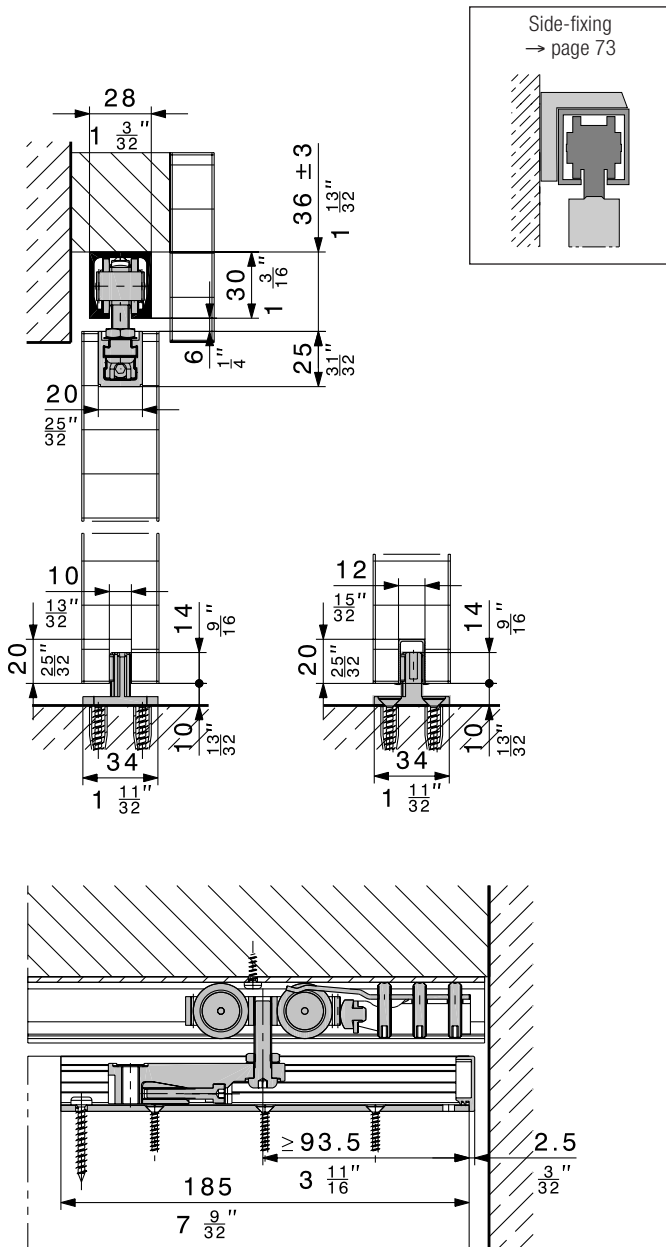

Top tracks

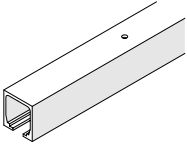
| Caution: - Hole positions vary - Minor differences in colour are possible | | mm/inch | code |
|--|---|-------------------------------|-------|
|  | Top track, alu plain anodized, predrilled | 1400 (4'7 $\frac{1}{8}$ ") | 10213 |
| | | 1600 (5'3") | 10214 |
| | | 1800 (5'10 $\frac{7}{8}$ ") | 10215 |
| | | 2000 (6'6 $\frac{3}{8}$ ") | 10216 |
| | | 3000 (9'10 $\frac{1}{8}$ ") | 18530 |
| | | 4000 (13'1 $\frac{1}{2}$ ") | 18531 |
| | | 6000 (19'8 $\frac{7}{32}$ ") | 10211 |
| | cut to size | 10217 | |

Planning/installation

For planning and execution please use the installation instructions code 17689. (→ www.hawa.ch → HAWA-Productfinder)

HAWA-Junior hardware may also be used for glass sliding doors. Please request the corresponding documentation.