

Locking Devices

Lockcases | Cylinders | Standards



Technical Details

BS EN 12209: 2003 Mechanically operated locks, latches and locking plates.

Products tested to British and European standards provide greater durability, longer warranty periods, peace of mind and evidence of professional specification.

Under the standard each product is tested and classified accordingly to show its compliance.

The identification of an 11-digit code is visible on the individual product. Each digit represents a category and how it measured against the standard to which it was tested.

Digit 1: Category of use

1 = Light use. For use by people with a high incentive to exercise care and with a small chance of misuse.

2 = Normal use. For use by people with some incentive to exercise care but where there is some chance of misuse.

3 = Extreme use. For use by people where there is little incentive to exercise care and where there is a high chance of misuse.

Digit 2: Durability

A = 50,000 test cycles; no load on latch bolt.

B = 100,000 test cycles; no load on latch bolt.

C = 200,000 test cycles; no load on latch bolt.

F = 50,000 test cycles; 10 N load on latch bolt.

G = 100,000 test cycles; 10 N load on latch bolt.

H = 200,000 test cycles; 10 N load on latch bolt.

L = 100,000 test cycles; 25 N load on latch bolt.

M = 200,000 test cycles; 25 N load on latch bolt.

R = 100,000 test cycles; 50 N load on latch bolt.

S = 200,000 test cycles; 50 N load on latch bolt.

W = 100,000 test cycles; 120 N load on latch bolt.

X = 200,000 test cycles; 120 N load on latch bolt.

Digit 3: Door mass and closing force

1 = up to 100kg door mass; 50 N maximum closing force.

2 = up to 200kg door mass; 50 N maximum closing force.

3 = above 200kg door mass or specified by the manufacturer; 50 N maximum closing force.

4 = up to 100kg door mass; 25 N maximum closing force.

5 = up to 200kg door mass; 25 N maximum closing force.

6 = above 200kg door mass or specified by the manufacturer; 25 N maximum closing force.

7 = up to 100kg door mass; 15 N maximum closing force.

8 = up to 200kg door mass; 15 N maximum closing force.

9 = above 200kg door mass or specified by the manufacturer; 15 N maximum closing force.

Digit 4: Suitability for use on fire/smoke doors

0 = not approved for use on fire/smoke resisting door assemblies.

1 = suitable for use on fire/smoke resisting assemblies, subject to satisfactory assessment of the contribution of the lock or latch to the fire resistance of specified fire/smoke resisting door assemblies.

Digit 5: Safety

Only 1 grade of safety is identified.

0 = no safety requirement.

Digit 6: Corrosion resistance and temperature

0 = no defined corrosion resistance, no temperature requirement.

A = low corrosion resistance, no temperature requirement.

B = moderate corrosion resistance, no temperature requirement.

C = high corrosion resistance, no temperature requirement.

D = very high corrosion resistance, no temperature requirement.

E = moderate corrosion resistance, temperature requirement from -20°C to +18°C.

F = high corrosion resistance, temperature requirement from -20°C to +18°C.

G = very high corrosion resistance, temperature requirement from -20°C to +18°C.

Digit 7: Security and drill resistance

1 = minimum security and no drill resistance.

2 = low security and no drill resistance.

3 = medium security and no drill resistance.

4 = high security and no drill resistance.

5 = high security with drill resistance.

6 = very high security and no drill resistance.

7 = very high security with drill resistance.

Digit 8: Field of door application

15 grades of door application are identified and summarised in the table below:

Grade	Type	Application 1	Application 2	Application 3
A	Mortice	Unrestricted application		
B	Mortice	Hinged door		
C	Mortice	Sliding door		
D	Rim	Unrestricted application		
E	Rim	Hinged door		
F	Rim	Sliding door		
G	Bored lock	Unrestricted application		
H	Mortice	Hinged door	Supported	
J	Rim	Hinged door	Inwards	
K	Mortice	Hinged door		Locked from inside
L	Mortice	Sliding door		Locked from inside
M	Rim	Hinged door		Locked from inside
N	Rim	Sliding door		Locked from inside
P	Mortice	Hinged door	Supported	Locked from inside
R	Rim	Hinged door	Inwards	Locked from inside

Technical Details

BS EN 12209:2003 Mechanically operated locks, latches and locking plates.

Digit 9: Type of key operation and locking

- 0 = not applicable.
- A = cylinder lock or latch, manually locking.
- B = cylinder lock or latch, automatically locking.
- C = cylinder lock or latch, manually locking with intermediate locking.
- D = lever lock or latch, manually locking.
- E = lever lock or latch, automatically locking.
- F = lever lock or latch, manually locking with intermediate locking.
- G = lock or latch without key operation, manually locking.
- H = lock without key operation, automatically locking.

Digit 10: Type of spindle operation

- 0 = lock or latch without follower.
- 1 = lock or latch for knob or sprung lever handle operation.
- 2 = lock or latch for unsprung lever handle operation.
- 3 = lock or latch for heavy duty unsprung lever handle operation.
- 4 = lock or latch for heavy duty unsprung lever handle operation specified by the manufacturer.

Digit 11: Key identification requirement

- 0 = no requirements.
- A = minimum three detaining elements.
- B = minimum five detaining elements.
- C = minimum five detaining elements, extended number of differs.
- D = minimum six detaining elements.
- E = minimum six detaining elements, extended number of effective differs.
- F = minimum seven detaining elements.
- G = minimum seven detaining elements extended number of effective differs.
- H = minimum eight detaining elements, extended number of effective differs.

Example:

2 H 5 1 0 E 5 A F 2 C

The above code signifies a mechanically operated lock and locking plate for use in an application where people have an incentive to exercise care, able to withstand a durability of 200,000 cycles with a 10 N load on the latch bolt, on a door with a mass of up to 200kg and a maximum closing force of 25N, suitable for use on a fire/smoke resisting door assembly, no safety requirement, moderate corrosion resistance in temperatures ranging from -20°C to +18°C, with high security and drill resistance for any use in any mortice application, with a manual locking lever lock or latch unsprung lever handle operation, a minimum of five deadlocking elements and an extended number of effective differs.

Marking:

The standard requires the following additional information to accompany the CE Marking required for locks and latches intended for use on fire resisting doors and smoke control doors.

- a) The identification number of the notified certification body.
- b) The name or identifying mark of the manufacturer.
- c) The registered address of the manufacturer.
- d) The last two digits of the year in which the marking was applied.
- e) The number of the EC certificate of conformity, reference to EN 12209:2003.
- f) The classification code of the product.

Euro Locks



European lock case range produced to DIN standards and dimensions, offering reliable heavy duty locks in standard applications.

All 55mm backset only.

Single throw deadbolt locks are suitable for use with unsprung lever handles.

Investment casting of the followers and guided deadbolt mechanism make this a severe duty range.

Available radius and square.

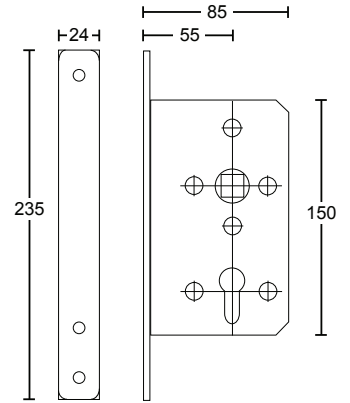

Deadlock

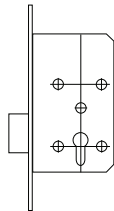

IL001

Sashlock

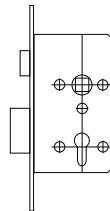

IL002

Bathroom Lock

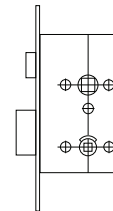

IL003

Latch

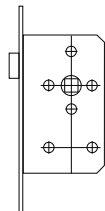

IL004

Escape Nightlatch

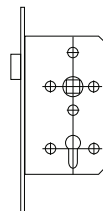

IL005

Anti-thrust Escape Nightlatch

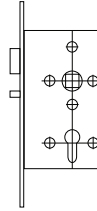

IL006

Anti-panic Sashlock

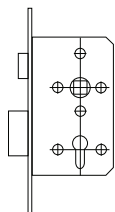

IL007



Finishes

Satin stainless steel
Polished brass



Standards

BS EN 12209
Certifire Approved
Produced to DIN Standards and dimensions



Rebate Sets

12mm and 25mm rebate sets are available.

Versatile Locks



A comprehensive series of locks giving standard and special applications.

Heavy duty high security locking options.

The same case accepts British oval and European profile cylinders. Available with square or radius forend.

All locks come with boxed keeps.

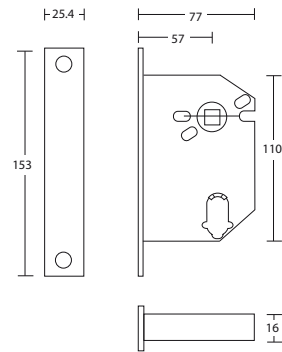

Heavy Duty –High Security

Sashlock

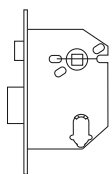

IL010

Deadlock

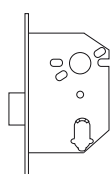

IL011

Bathroom Lock

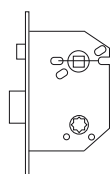

IL012

Latch

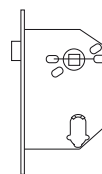

IL013

Deadbolt
30 x 11mm
20 mm throw

Latchbolt
11.5mm throw

HEAVY DUTY AUTO DEADLOCKING

Nightlatch Snib Holdback

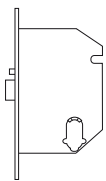

IL014

Nightlatch No Holdback

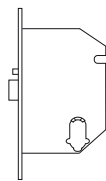

IL015

Escape Nightlatch No Holdback

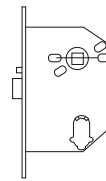

IL016

Escape Nightlatch Snib Holdback

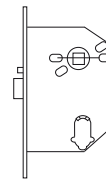

IL017

Escape nightlatch non deadlocking version IL018

HEAVY DUTY HIGH SECURITY SPECIAL APPLICATION LOCKS

Escape Sashlock

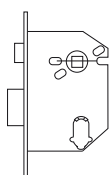

IL019

Internal – lift lever to lock depress lever to withdraw latch and deadbolt simultaneously
External – lever operates latch bolt only, cylinder operates deadbolt

Escape Deadlock

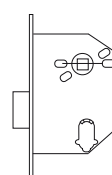

IL020

Internal – lift lever to lock depress lever to unlock
External – cylinder operates deadbolt
Both locks must use single cylinders only

Modular Lockcases



This severe duty range of locks offer a vast array of interchangeable applications. Using a symmetrical modular system gives the ability to change the function of the door easily. Compatible with Scandinavian oval cylinders only. The cylinder follower is above the handle line. Supplied with radius forends, ideal for factory prepared doors. Lockcases have a substantial 21mm throw deadbolt and 14mm projecting latchbolt. Uses unsprung lever handles only.

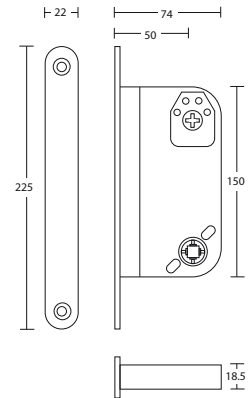

For BS EN179 escape functions, refer to Escape Hardware brochure.

Sash Lock

Standard

High Security

Escape Function

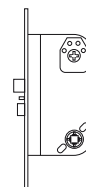
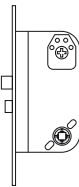
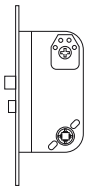

Case
50mm
70mm

IL021-A
IL021-B

IL022-A
N/A

IL023-A
IL023-B

For bathroom lock use either standard sashlock or standard deadlock with 62.0500 5mm follower conversion for use with indicator and turn.

Dead Lock

Standard

High Security

Sliding Door
(hookbolt)

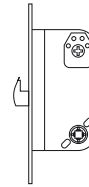
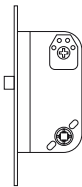
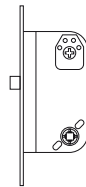

Case
50mm
70mm

IL024-A
IL024-B

IL025-A
IL025-B

IL026-A
N/A

Nightlatch (Auto-Dead Locking)

With Snib
Holdback

With Faceplate
Key Holdback

No Holdback

Non Auto-
Deadlocking

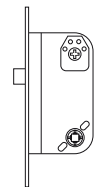
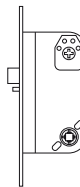
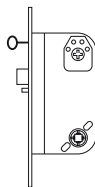
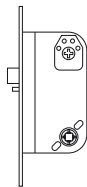

Case
50mm
70mm

IL027-A
IL027-B

IL028-A
IL028-B

IL029-A
IL029-B

IL030-A
IL030-B

Modular Lockcases

Escape Nightlatch – Auto Deadlocking

Heavy Sprung
No Hold Open

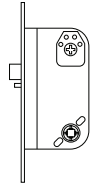

50mm
70mm

IL031-A
IL031-B

Heavy Sprung
Faceplate Key
Holdback

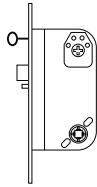

IL032-A
IL032-B

Heavy Sprung
No Hold Open
Non Deadlocking

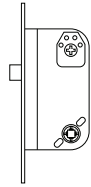

N/A
IL032-B

Light Sprung
No Hold Open

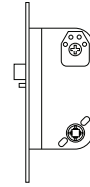

IL033-A
IL033-B

Light Sprung
Faceplate Key
Holdback

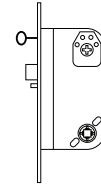

IL034-A
IL034-B

Double Latch Lock (Auto-Deadlocking)

Latch

With Snib Holdback

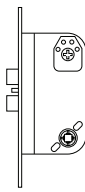

50 mm
70 mm

IL036-A
IL037-B

With Faceplate
Key Holdback

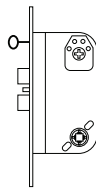

IL037-A
IL037-B

No Holdback

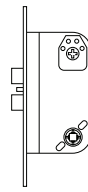

IL038-A
IL038-B

Escape Function

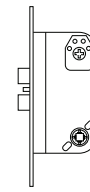

IL039-A
IL039-B

Standard Latch

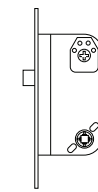

IL040-A
IL040-B



Finishes

SCP – Satin chrome plated
PB – Polished brass plated
PCP – Polished chrome plated



Handing Details

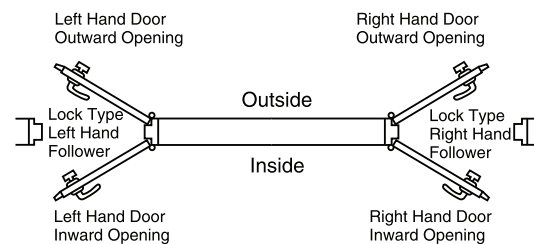

Standards

BS EN 12209



REB ATE SETS

13mm, 19mm and 25mm rebate sets are available.

British Locks



A traditional range of locks to typical British dimensions, giving standard locking functions applicable to most common uses. Available pierced to take British Oval and Euro cylinders or 5 lever, where applicable. Light sprung (LS) or heavy sprung (HS) dependent on furniture selected. Brass latch and deadbolt with hardened steel rollers.

Detailed here are just a few functions. There are many special applications and non-standard locking solutions. Please contact Lloyd Worrall for further information.

Sash Lock

British Oval
Cylinder

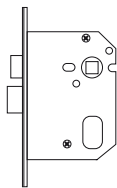

IL041-A
IL041-B
IL041-C

European
Profile Cylinder

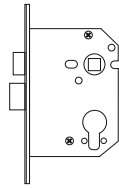

IL042-A
IL042-B
IL042-C

5 Lever
Locking

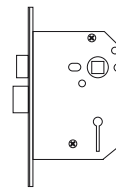

IL043-A
IL043-B
IL043-C

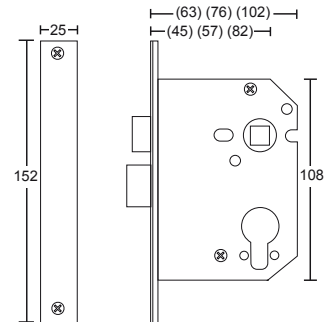

Case
63mm
76mm
102mm

Dead Lock

British Oval
Cylinder

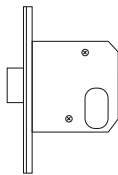

IL044-A
IL044-B
IL044-C

European
Profile Cylinder

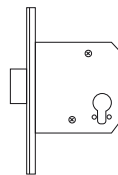

IL045-A
IL045-B
IL045-C

British Oval
Cylinder Clawbolt

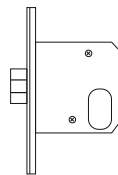

N/A
IL046-B
N/A

5 Lever
Locking

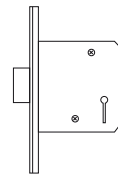

IL047-A
IL047-B
N/A

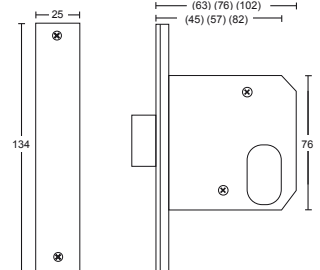

Case
63mm
76mm
102mm

Bathroom Locks

5mm Deadbolt
Follower Sashlock

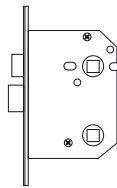

IL048-A
IL048-A
IL048-C

8mm Deadbolt
Follower Sashlock

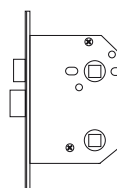

IL049-A
IL049-B
IL049-C

5mm Deadbolt
Follower

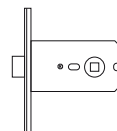

N/A
IL050-B
N/A

8mm Deadbolt
Follower

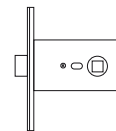

N/A
IL051-B
N/A

Case
63mm
76mm
102mm

Backset
45mm
57mm
82mm

British Locks

Latch

Upright
Mortice Latch

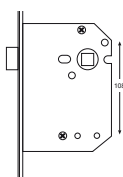

Small Case
Mortice Latch

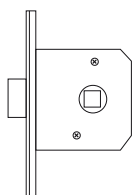

Pocket Case
Mortice Latch

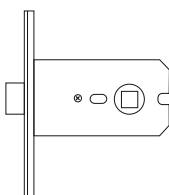

Case
63mm
76mm
102mm

IL052-A
IL052-B
IL052-C

IL053-A
IL053-B
N/A

N/A
IL054-B
N/A

Backset
45mm
57mm
82mm

Horizontal

British Oval
Cylinder Sashlock

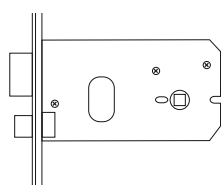

5 Lever
Locking Sashlock

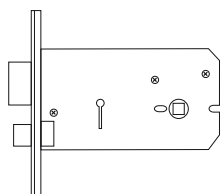

Mortice Bathroom
Lock

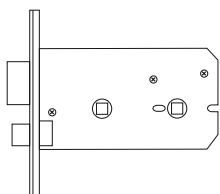

Mortice Latch

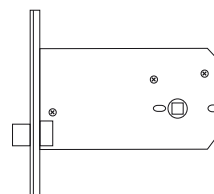

Case
127mm
151mm

IL055-A
IL055-B

IL056-A
IL056-B

IL057-A
IL057-B

IL058-A
IL058-B

Backset
45mm
57mm

Centres
57mm
70mm

Indicator bolts

Suitable for 13mm and 20mm board. Concealed bolt through fixings. Satin stainless steel. Keep sold separately.



IL201 Turnbolt with indicator release.

IL202 Extended turnbolt with indicator release.

IL203 Budget turnbolt with indicator release.



Rebate Sets

13mm, 19mm and 25mm rebate sets are available.



OPTIONS

5 lever locks available master keyed or keyed alike.



Finishes

Satin stainless steel, brass, bronze metal, antique, polished chrome.

Narrow Style Locks



A narrow style range of locks for the fabrication market.

Covering all the popular functions this is an ideal accompaniment to the other ranges.

Standard stock backset of 30mm.

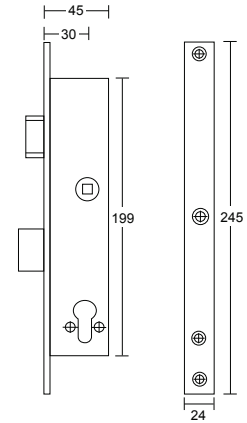

Sashlock

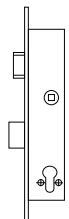

IL060

Rollerbolt Sashlock

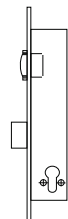

IL061

Anti-panic Lock

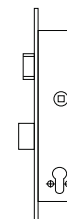

IL062

Deadlock

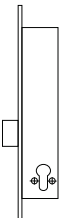

IL063

Sliding Door Lock

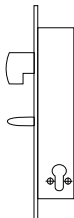

IL064

Small Case Deadlock

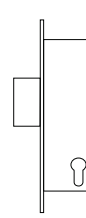

IL065

Escape Nightlatch

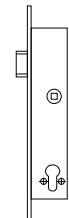

IL066

Latch



IL067



Finishes

SSS – Satin stainless steel.



Options

Also available in 25mm, 35mm, 40mm and 45mm backset.



Standards

BSEN 12209.
DIN 18251.

Detainer Locks

nightl at ch

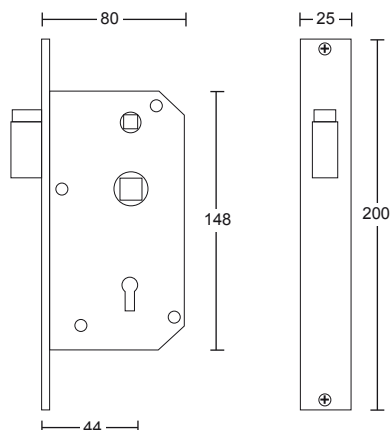

Internal handle, external key, with snib holdback facility.

IL070-LH Lockable Internal Handle LH
IL070-RH Lockable Internal Handle RH

IL071-LH Non-lockable Internal Handle LH
IL071-RH Non-lockable Internal Handle RH

13mm, 19mm and 25mm rebate sets are available.

Most door furniture can be used with this lock with minor adjustment.
Please indicate which door furniture is to be used with these locks.

Sash Lock

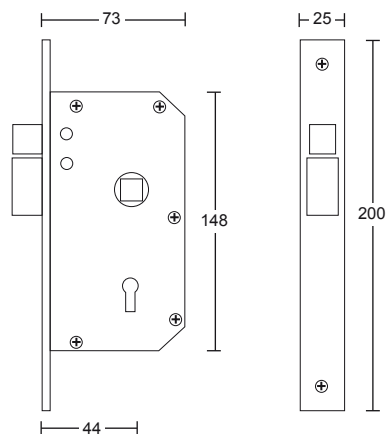

IL072 Standard Sashlock Function

13mm, 19mm and 25mm rebate sets are available.

Most door furniture can be used with this lock with minor adjustment.
Please indicate which door furniture is to be used with these locks.

5 lever Locks

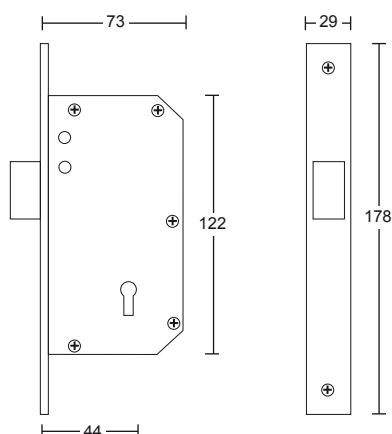

IL073 Standard Deadlock Function

13mm, 19mm and 25mm rebate sets are available.



Finishes

SSS – Satin stainless steel.
BRS – Brass.



Standards

CE Marked.
BS3621-1997 (IL073)



Options

Restricted key duplication (RKS). Master keyed with each other (MK).
Can be fitted with microswitch. Single Pole (SP) or Double pole (DP).

Cylinders

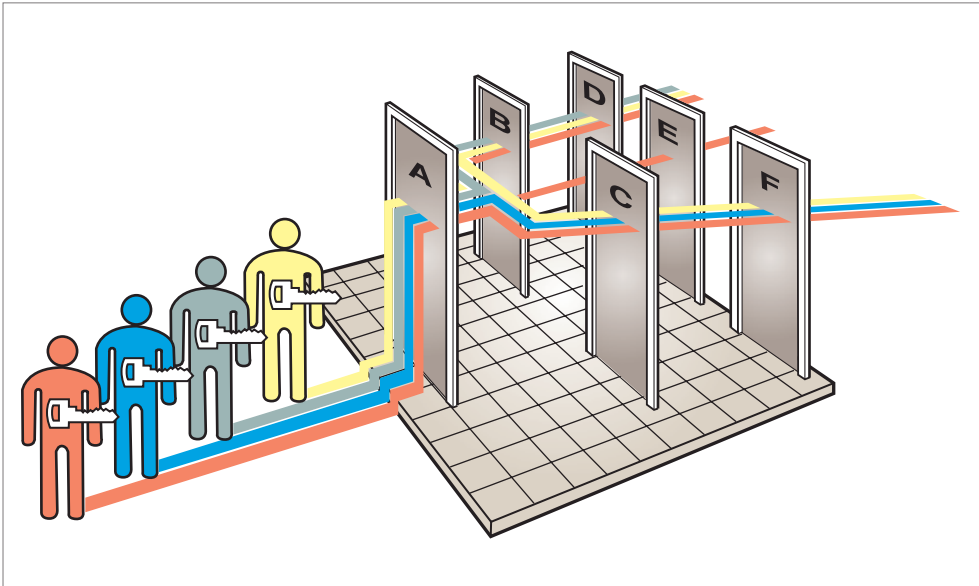

Technical Details

BS EN 1303: 2005 Revision 1 Cylinders for Locks Requirements and Test Methods

Products tested to British and European standards provide greater durability, longer warranty periods, peace of mind and evidence of professional specification.

Under the standard each product is tested and classified accordingly to show its compliance. The identification of an 8-digit code is visible on the individual product. Each digit represents a category and how it measured against the standard to which it was tested.

Digit 1: Category of use

Only one category is identified.

1 = keys shall resist a torque of 2.5Nm and still be usable.

Digit 2: Durability

Three grade of durability will classify cylinders as either grade 4, 5 or 6 based on the number of test cycles achieved.

4 = 25,000 cycles.

5 = 50,000 cycles.

6 = 100,000 cycles.

Key strength is also tested to ensure there is no failure of the key within the durability test.

Digit 3: Door mass

No requirement.

Digit 4: Fire resistance

0 = no requirement.

1 = cylinders shall be fire tested in accordance with current fire test requirements or BS EN 1634-1.

Digit 5: Safety

No requirement.

Digit 6: Corrosion resistance

0 = no requirement.

A = conforms to grade 3 of BS EN 1670 as a minimum.

B = will resist temperature extremes of -20/+80°C

C = conforms to grade 3 of BS EN 1670 as a minimum and will resist temperature extremes of -20/+80°C.

Digit 7: Key security

Cylinders are classified in grades 1 to 6, where 6 is the highest. The grade can differ from one side of a double cylinder to the other. The table below provides a summary of the main security criteria:

Requirement	Unit	Grades					
		1	2	3	4	5	6
Min number of effective differs	Number	100	300	15,000	30,000	30,000	100,000
Min number of movable retainers	Number	3	3	5	5	6	6
Max number of steps	-	100	70	60	60	60	50
Direct coding on key	%	Yes	Yes	No	No	No	No
Torque resistance of plug/cylinder	Nm	2.5	5	15	15	15	15

Digit 8: Attack resistance

Cylinders are classified in grades 0, 1 and 2, where 2 is the highest. The table below provides a summary of the main requirements:

	Grade		
	0	1	2
Resistance to drilling (nett drilling time)	-	3 mins	5 mins
Resistance to chisel attack (number of defined blows)	-	30	40
Resistance to twisting attack (number of defined twists)	-	20	30
Resistance to plug/cylinder extraction (pull load)	-	15 kN	15 kN

Example:

1 6 - 0 - B 3 1

The above code signifies a cylinder meeting the required category of use, durability grade 6 with no fire resistant requirement, will resist temperature extremes of -20/+80 °C, has a grade 3 key security and grade 1 attack resistance.

Marking:

This standard requires that the classification relevant to the cylinder shall be quoted in the accompanying documentation, on its labelling or packing and/or by marking the product itself or by more than one of these methods.

The marking/labelling shall include the following:

- a: manufacturer's name or trademark, or other means of identification,
- b: product model identification,
- c: the 8 digit classification listed above,
- d: number of this European standard.

11 pin patented cylinders



Six pin tumblers plus sidebar mechanism with five sidepins. Mechanism and keyblanks are protected by worldwide patents. Incorporates anti-drill and anti-pick protection. 1.9 billion usable combinations. Dual security levels may be combined with lower cost medium security cylinders in the same system. Designed for large or complex master key systems. Assembled in our workshop facility.

There is a strict registration procedure and all keys are uniquely marked for greater key control.

cylinder with thumbturns

Oval Turn (7)

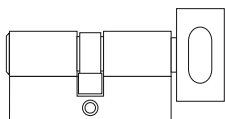

Stainless Steel (6) Turn (Large)

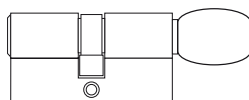

Euro



IL102-A
IL102-B
IL102-C

IL103-A
IL103-B
IL103-C

61mm
71mm
81mm

Oval



IL109-A
IL109-B
IL109-C

IL110-A
IL110-B
IL110-C

61mm
71mm
81mm

Stainless Steel (9) Turn (Small)

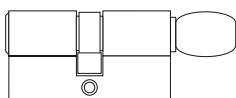

Large Turn (1)

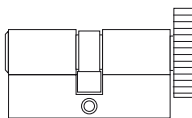

Euro



IL104-A
IL104-B
IL104-C

IL105-A
IL105-B
IL105-C

61mm
71mm
81mm

Oval



IL111-A
IL111-B
IL111-C

IL112-A
IL112-B
IL112-C

61mm
71mm
81mm

Single Turn

Oval Turn (7)



Turn Large (6)

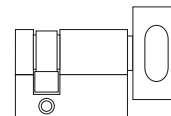

Euro



IL107-A 40mm
IL107-B 45mm
IL107-C 50mm

Round Turn (1)



Turn Small (9)



Oval



IL113-A 40mm
IL113-B 45mm
IL113-C 50mm

Specify Turn (1,6,7 or 9) when ordering.



Finishes

1, 7: SCP, PCP, PB.

6, 9: SSS.

11 pin patented cylinders

Double

Single

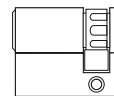
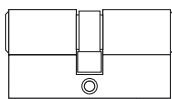

Euro



61mm IL101-A
71mm IL101-B
81mm IL101-C

40mm IL106-A
45mm IL106-B
50mm IL106-C

Oval



61mm IL108-A
71mm IL108-B
81mm IL108-C

40mm IL114-A
45mm IL114-B
50mm IL114-C

Single Outside

Single Internal

Scandinavian Oval

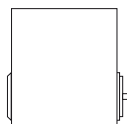
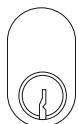

IL115

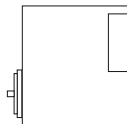

IL116

IL117

Scandinavian double cylinder consists of 1 each of IL115 and IL116.

Rim Cylinder

Screw IN MORTICE CYLINDER

Round

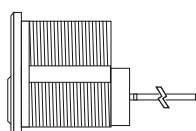
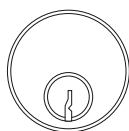

IL118

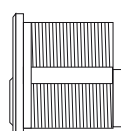

IL119

Padlocks

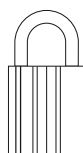

IL120

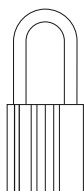

IL121

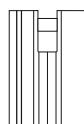

IL122

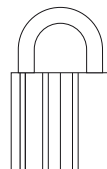

IL123

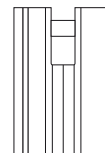

IL124

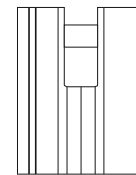

IL125



Finishes

Satin chrome plated, polished chrome plated, polished brass, black chrome (padlocks).



Standards

International Patent protected. BS EN 1303 grade 5 cylinder. BS EN 12320 grade 3 to 6 padlocks.

5 pin patented cylinders



A medium security five pin tumbler with longitudinal pin. Mechanism and key blanks are protected by international patents.

29,000 - usable differs for small to medium size master key systems.

Assembled in our own workshops.

cylinder with thumbturns

Oval Turn (7)

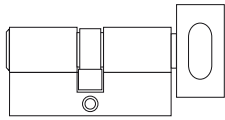

Stainless Steel (6) Turn (Large)

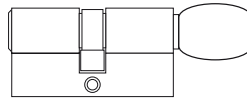

Euro



IL130-A
IL130-B
IL130-C

IL131-A
IL131-B
IL131-C

61mm
71mm
81mm

Oval



IL134-A
IL134-B
IL134-C

IL135-A
IL135-B
IL135-C

61mm
71mm
81mm

Stainless Steel (9) Turn (Small)

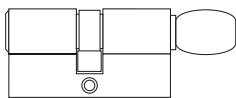

Large Turn (1)

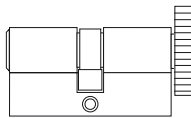

Euro



IL132-A
IL132-B
IL132-C

IL133-A
IL133-B
IL133-C

61mm
71mm
81mm

Oval



IL136-A
IL136-B
IL136-C

IL137-A
IL137-B
IL137-C

61mm
71mm
81mm

Single Turn

Oval Turn (7)



Turn Large (6)



Round Turn (1)



Turn Small (9)

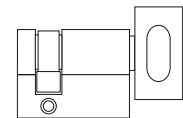

Euro



IL138-A 40mm
IL138-B 45mm
IL138-C 50mm

Oval



IL139-A 40mm
IL139-B 45mm
IL139-C 50mm

Specify Turn (1,6,7 or 9) when ordering.



Finishes

1, 7: SCP, PCP, PB.

6, 9: SSS.

5 pin patented cylinders

Double

Single

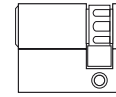
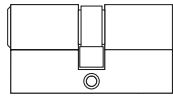

Euro



61mm IL140-A
71mm IL140-B
81mm IL140-C

40mm IL141-A
45mm IL141-B
50mm IL141-C

Oval



61mm IL142-A
71mm IL142-B
81mm IL142-C

40mm IL143-A
45mm IL143-B
50mm IL143-C

Single Outside

Single Internal

Scandinavian Oval

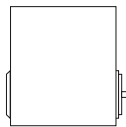
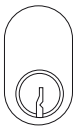

IL144

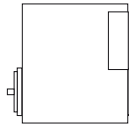

IL145

IL117

Scandinavian double cylinder consists of 1 each of IL144 and IL145.

Rim Cylinder

Screw IN MORTICE CYLINDER

Round

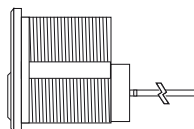
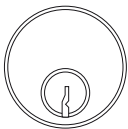

IL146

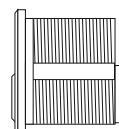

IL147

Padlocks

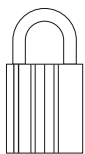

IL148

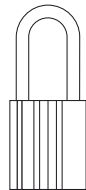

IL149

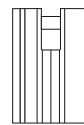

IL150

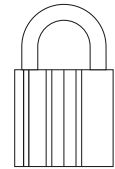

IL151



Finishes

Satin chrome plated, polished chrome plated, polished brass, black chrome (padlocks).



Standards

International Patent protected. BS EN 1303 grade 4. BS EN 12320 grade 3.

For more information on our full range of locking devices products and services, please contact us or your local branch:

Lloyd Worrall Group
The Quadrant
99 Parkway Avenue
SHEFFIELD
S9 4WG
T: 0114 213 2860
F: 0114 261 9427
E: enquiries@lloydworrall.co.uk

www.lloydworrall.co.uk



Lloyd Worrall

Lloyd Worrall
Unit 2, Bilton Road
Bletchley
MILTON KEYNES
MK1 1HW
T: 01908 622 650
F: 01908 622 651
E: miltonkeynes@lloydworrall.co.uk

Lloyd Worrall
Unit 13, Chamberlayne Road
Moreton Hall Ind. Est.
BURY ST EDMUNDS
IP32 7EY
T: 01284 762 002
F: 01284 762 003
E: bury@lloydworrall.co.uk

Lloyd Worrall
Unit 10, Attercliffe Common Ind. Est.
Fell Road
SHEFFIELD
S9 2AL
T: 0114 244 3350
F: 0114 244 4219
E: sheffield@lloydworrall.co.uk

Lloyd Worrall
Unit 2, Tenax Cross
Tenax Road, Trafford Park
MANCHESTER
M17 1AZ
T: 0161 873 5301
F: 0161 873 5302
E: manchester@lloydworrall.co.uk

Lloyd Worrall
Units 13-16, Noble Street Ind. Est.
off Scotswood Road
NEWCASTLE UPON TYNE
NE4 7PD
T: 0191 226 0888
F: 0191 226 0803
E: newcastle@lloydworrall.co.uk

www.lloydworrall.co.uk

Yannedis

Yannedis
2 Dace Road
Bow
LONDON
E3 2NQ
T: 020 8525 6898
F: 020 8525 6899
E: ask@yannedis.com

www.yannedis.com

Classic Hardware

Classic Hardware
Osbalwick Link Road
YORK
YO10 3WA
T: 01904 420 490
F: 01904 420 493
E: ask@classichardware.co.uk

www.classichardware.co.uk

MB Architectural

MB Architectural
14a Falcon Road
BELFAST
BT12 6RD
T: 028 9038 0200
F: 028 9038 0201
E: ask@mbarchitectural.com

www.mbarchitectural.com