





LINEAR

DEMOUNTABLE T-GRID CEILING

Distinctive look with floating tile effect. Acoustic ceiling with low installation depth. Exceptionally easy to install and demount giving quick and easy access to installations.

- Visona
- Contur
- Belgravia
- Linear
- Markant
- Plaza
- Danotile
- Medley



DID YOU KNOW THAT ...

22% of gypsum's mass is water, which is bound to the gypsum crystal and ensures the fire protective properties of gypsum boards?

LINEAR

DEMOUNTABLE T-GRID CEILING

SIZES

600 x 600 x 12.5 mm

SURFACE

Standard white painted surface
(closest match RAL 9003, gloss 5)
Other colours available on request

DANISH INDOOR CLIMATE LABELLING (DIM)

Indoor value: 10 days
Particle emission: low (< 0.75 mg)

CLEANING

Dust is removed using a dry duster or vacuum cleaner. Marks can be removed with a damp cloth using normal cleaning practices and neutral cleaning solutions.

LIGHT REFLECTION

Globe: 72.8%
Quadril: 75.1%
Micro: 72.1%
Regula: 82.6%

AMBIENT CONDITIONS

The product is designed to perform under normal conditions of use. Tested at 70% RH and 25°C. The product can withstand ambient temperatures of up to 50°C.

LOAD-BEARING CAPACITY

2 / A / No load

FIRE CLASS

A2-s1,d0

ROBUSTNESS

Made of robust, glass fibre reinforced material with excellent pressure resistance. Under normal conditions of use, the product properties are preserved and there is no decomposition of material over time.



ACOUSTICS

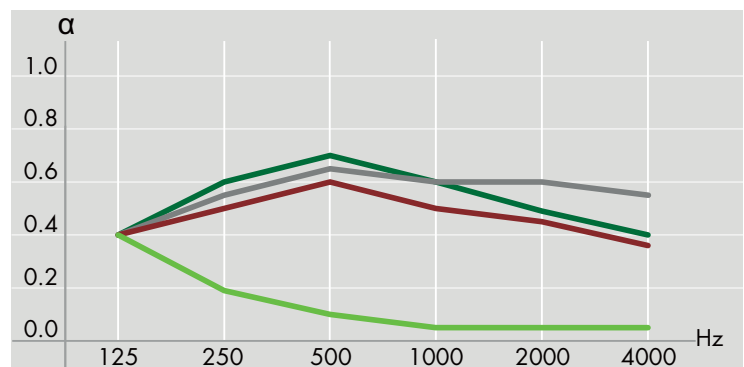

● α	0.40	0.60	0.70	0.60	0.50	0.40
● α	0.40	0.50	0.60	0.50	0.45	0.35
● α	0.40	0.55	0.65	0.60	0.60	0.55
● α	0.40	0.20	0.10	0.05	0.05	0.05

- Globe, 200 mm suspension, no mineral wool aw: 0.55, NRC: 0.60
- Quadril, 200 mm suspension, no mineral wool aw: 0.50, NRC: 0.50
- Micro, 200 mm suspension, no mineral wool aw: 0.65, NRC: 0.60
- Regula, 200 mm suspension, no mineral wool aw: 0.10, NRC: 0.05

For acoustic data on alternative constructions please see "Absorption Data" at knaufdanoline.com

Perforation	Tile weight*	Transportation weight*	Installed weight* *(kg/m ²)
Globe	9.0	9.5	10.5
Quadril	8.8	9.4	10.3
Micro	8.9	9.5	10.4
Regula	9.7	10.2	10.5



CERTIFICATES

- Declaration of Conformity (EN 14190)
- Danish Indoor Climate Labelling

PERFORATION

Also available as Regula. Other perforation patterns are manufactured to order.

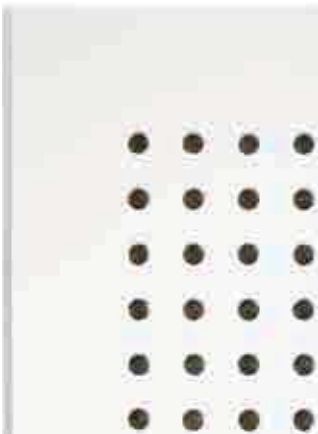

Globe, Ø6 mm,
15 mm c/c
Perforation: 9.1%

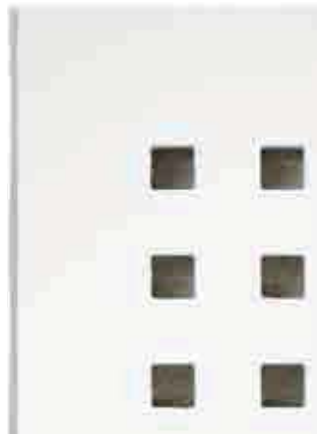

Quadril, 12 x 12 mm,
30 mm c/c
Perforation: 10.2%



Micro, 3 x 3 mm,
8.3 mm c/c
Perforation: 10.2%

EDGES



Edge C
(GROOVED) / S24
Semi-concealed grid

INSTALLATION GUIDE 600 x 600 mm module

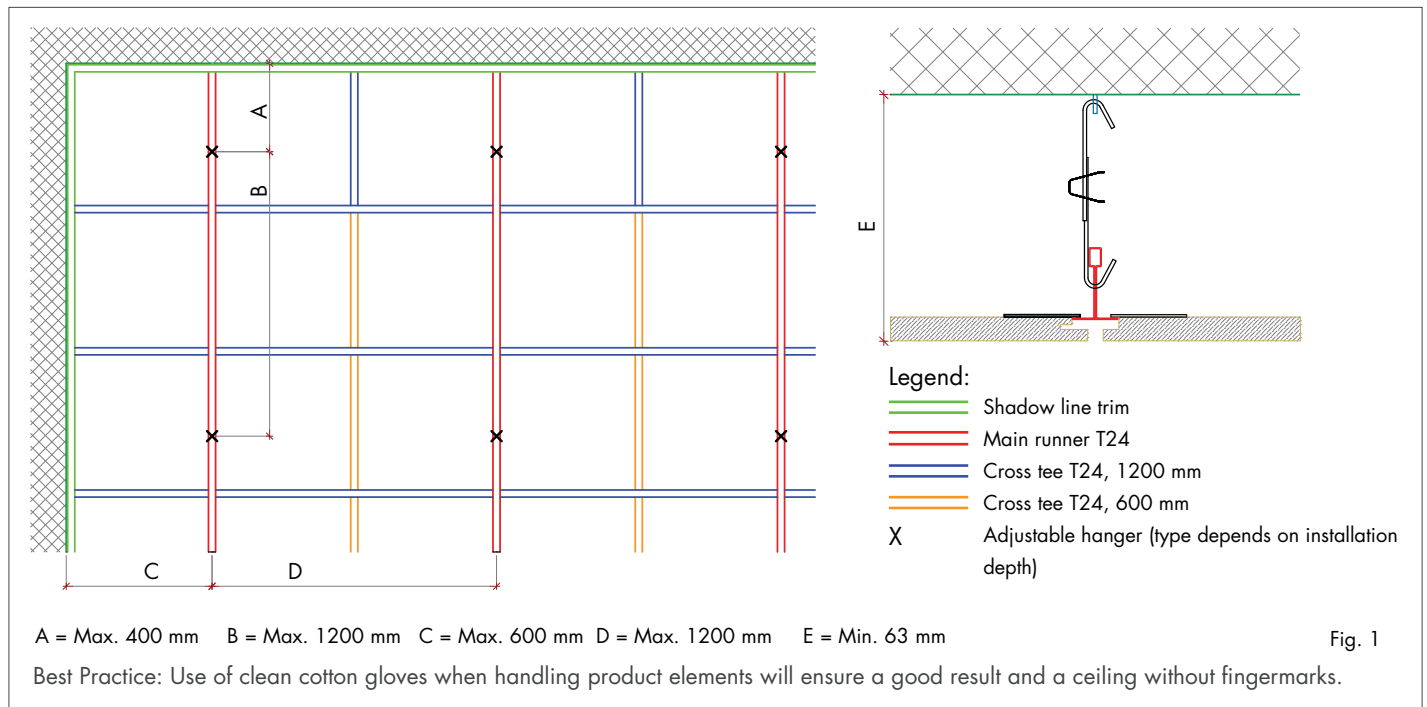
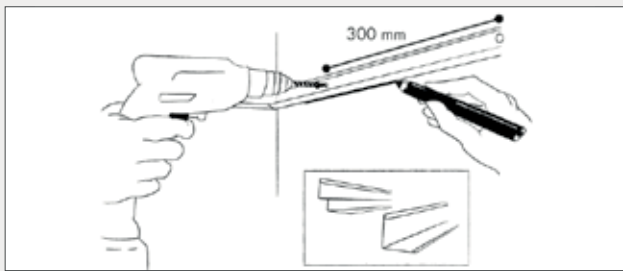
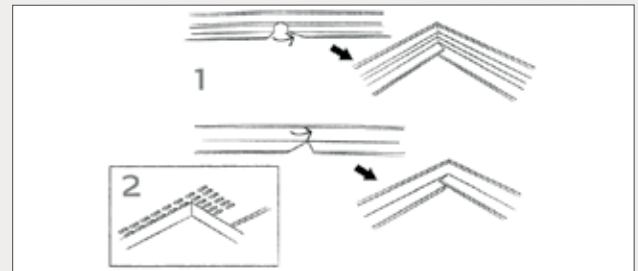

Fig. 1



MARKING AND WALL ANGLES

- Mark the location of the wall angles on the walls and columns in relation to the required ceiling height.
- Install the wall angles at max. 300 mm c/c. Choose the fixings in accordance with the substrate.



CORNERS

- Inside corners (1): cut the corners in a false mitre letting the ends overlap each other, unless anything to the contrary is specified. Finish with a corner cover, if necessary.
- Outside corners (2): must always be mitred. Finish with a corner cover if necessary.

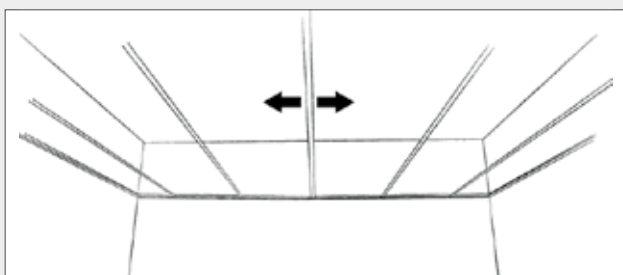

CEILING LAYOUT

- Divide the ceiling surface from the centre of the room or in accordance with the existing ceiling plans.
- The location of light fittings and ventilation units will have an influence on ceiling layout.
- Install the first main runner at max. 600 mm from the wall. The other main runners should be installed at 600/1200 mm c/c.

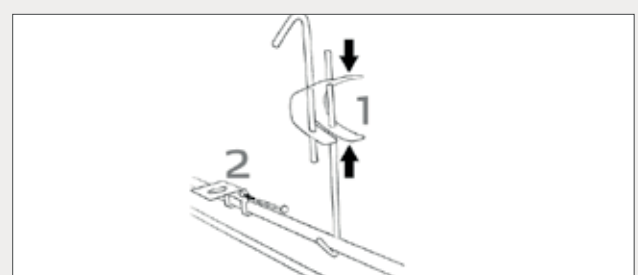

HANGERS

- Fix adjustable hangers (1) with eye screws or similar securely fastened to the primary construction.
- Direct hangers (2) are secured to the ceiling using appropriate fixings in accordance with the substrate and locked to the main runner with a nail.
- Install the first hanger at max. 400 mm from the wall. The other hangers should be installed at max. 1200 mm c/c.
- If loads from light fittings etc. are to be borne by the ceiling, install additional hangers.
- Refer to distances in figure 1.

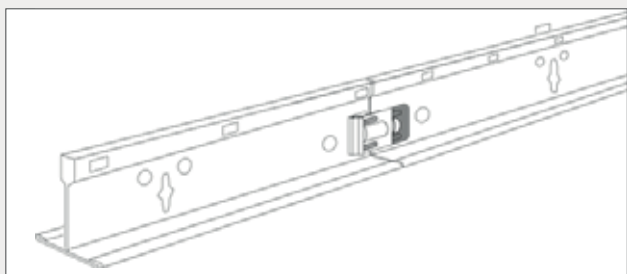

MAIN RUNNERS

- Install the main runners parallel to each other so that the slots are directly opposite each other.
- Join the main runners longitudinally by clicking them together.
- Adjust the lengths of the profiles with plate shears, a hacksaw or a cross-cut saw with a special blade.
- Make sure there is a hanger between the end joints of the main runners and the fire break.

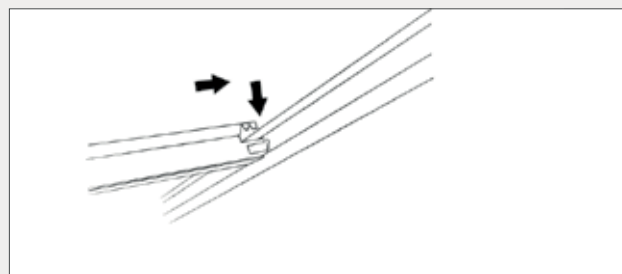

CROSS PROFILES

- Push the snap-in tongue into the slot on the main runner using light downward pressure.
- If there is a cross profile on the opposite side of the main runner, the new one must be on the left hand side of the one already in place.

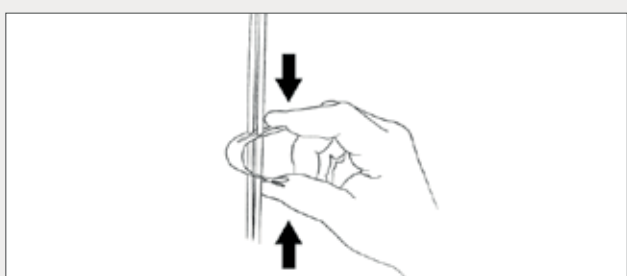

ADJUSTMENT

- Check that all profiles are correctly aligned when the entire suspension grid has been installed.
- Adjust the hangers so that they are taut and the ceiling surface is level.

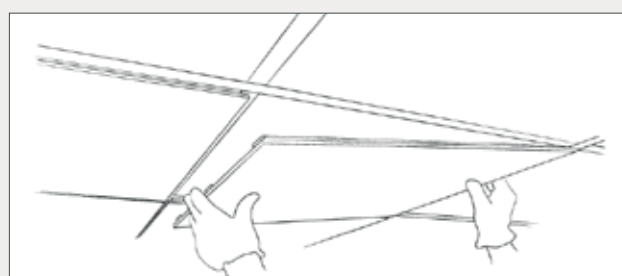

INSTALLATION

- Always wear clean cotton gloves when handling elements.
- Install the elements by pushing the side of the tile with the large groove across T-profile, lifting the opposite side of the tile towards the T-profile and pull the tile back. To ensure good alignment, it is important that the tiles are installed in the same orientation.
- Check that all metal clips are resting on the T-profiles and that the edges of the tile are between the profiles so that the tile is locked in position.
- Frieze tiles should be adjusted precisely according to the wall angle or shadow line trim. See detailed drawings on next page.
- As an alternative, the ceiling can be finished using Plaza or a fixed frieze - see detailed drawings on next page.

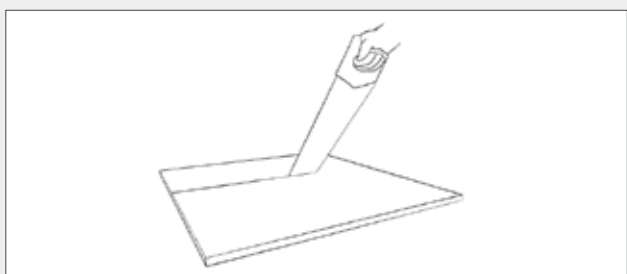

CUTTING AND FINISHING

- Découpez les éléments côté face apparente avec une scie à dents fines ou cutter.
- Si vous devez couper une plaque dotée de garnitures perforées, enlevez celles-ci d'abord.
- Saisissez chaque garniture avec une pince et extrayez-la délicatement.
- Vous pouvez remettre de nouvelles garnitures perforées avec la pince adéquate commercialisée à cet effet.

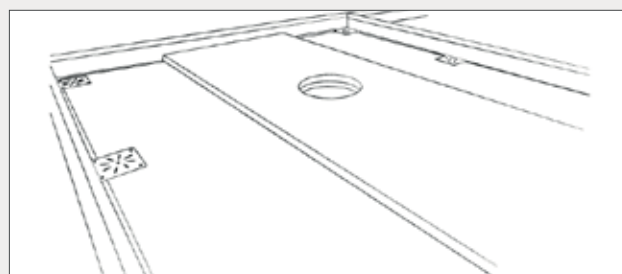

FIXTURES AND FITTINGS

- With smaller units (of up to 3kg) a reinforcement panel of sufficient strength can be installed behind the Linear element.
- The reinforcement panel must extend all the way into the main runners, so that the weight is transferred to them.
- The total weight should not be greater than 3kg for each m² of ceiling. Where loads are greater than 3kg/m², additional hangers must be used
- Units over 3kg, should be installed independently, so that they do not place any load on the ceiling.

DETAILS

Linear in grid system S24 direct to wall

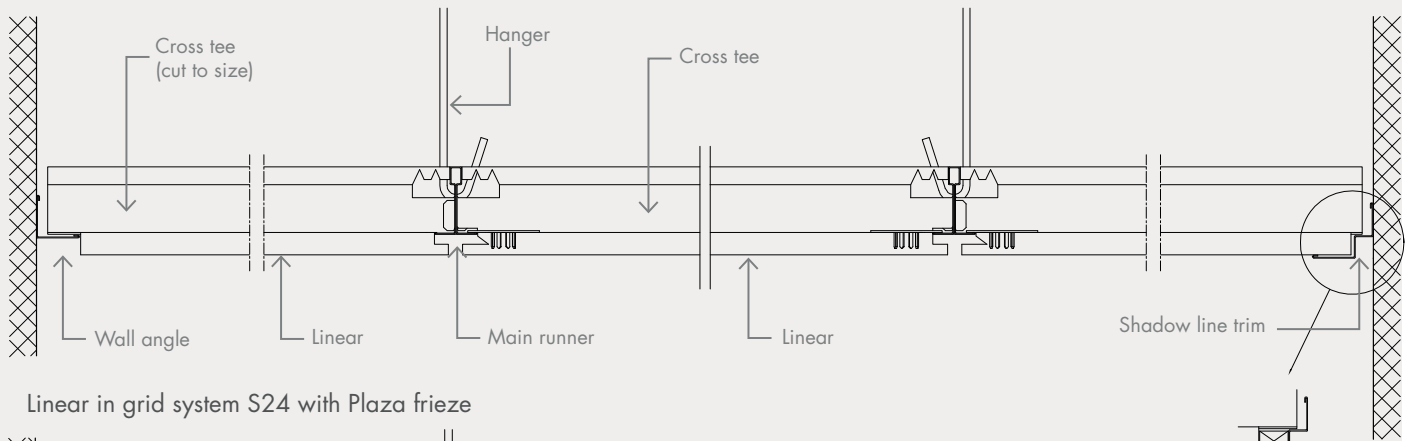



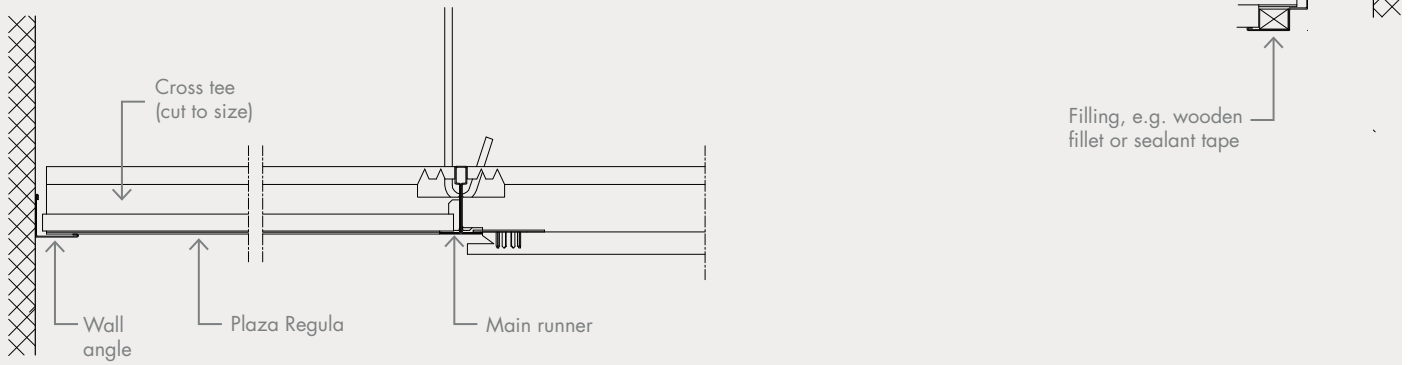



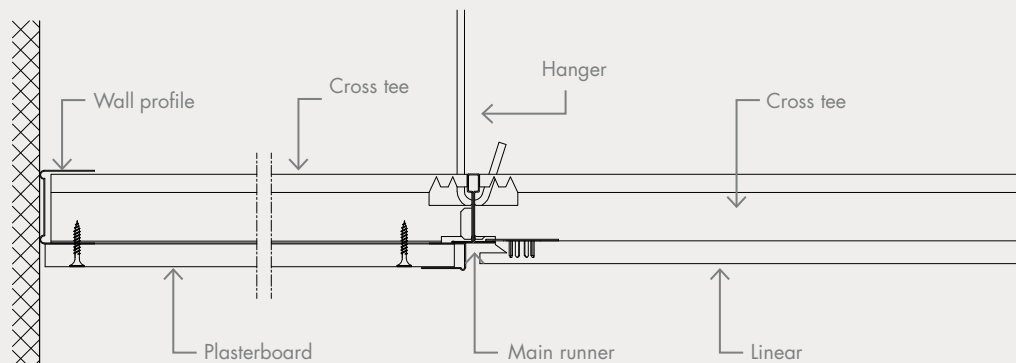
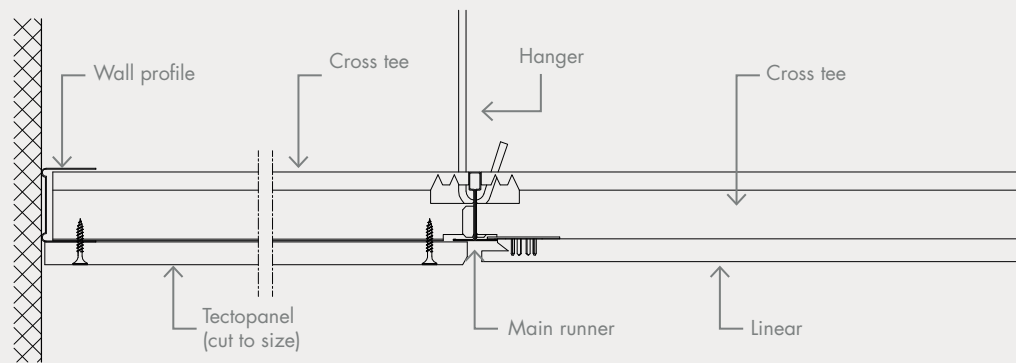

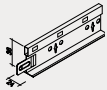
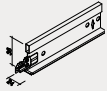
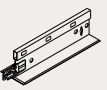

Linear in grid system S24 with Plaza frieze



Linear in grid system S24 with fixed frieze

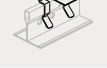
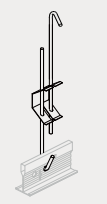

ACCESSORIES

PRODUCT NAME	SAP NO.	W x L x H (mm)
Main runner T24 	467385	24 x 3700 x 38
Cross tee T24 	467388 467389	24 x 600 x 38 24 x 1200 x 38
Cross tee T40 (galvanized) 	316299 316297	40 x 600 x 38 40 x 1200 x 38
Wall angle type MIE2024 	316325	20 x 3000 x 24
Shadow line trim type MS10 	316330	19+11 x 3000 / 13+19
Outside corner for wall angle 	3107 3108	for 24 mm Wall angle for 19 mm Wall angle
Inside corner for wall angle 	3109 3110	for 24 mm Wall angle for 19 mm Wall angle
Wall profile 	316346	32 x 3000 x 41
Direct hanger 	431912 316304 316302	21.5 21.8 21.1
Adjustable hanger The size specification indicates the min. and max. range 	469861 469868 469872 469876 469878 469880 469881	50 80 100 100 - 300 300 - 600 600 - 1000 1000 - 1250 1250 - 1500 1500 - 1750 1750 - 2000
Clips, Q perf. 	3385	40 x 40 1/11
Fixing tool for clips 	3372	-
Hold down clip 	3381	-
Repair kit White paint for prepainted tiles 	10110	100 mm NCS 0700

DANOPOR

Extra sound absorption and reduction as backing.
Mineral wool backing sealed in plastic bags.
No risk of dust particles.

SIZES

600 x 600 x 25 mm

600 x 600 x 50 mm



UPKEEP & MAINTENANCE

Best Practice: Use of clean cotton gloves when handling painted and foil-covered product elements will ensure a good result and a ceiling without fingermarks.

PRODUCT CATEGORY	DEMOUNTABLE T-GRID CEILINGS	
Products	Visona, Contur, Belgravia, Linear, Markant, Plaza	Danotile, Medley
Surface	White painted	Foil finish
Upkeep	Designed for use under normal conditions, i.e. up to 70% RH and 25°C, e.g. in offices, institutions and similar premises. Belgravia, Markant, Plaza and Danotile 600x600 have also been tested at 90% RH at 30°C and can be used under more extreme conditions such as kitchens, laboratories and rooms with frequent and major changes in the temperature and air humidity. Special purpose, anticorrosion treated suspension systems should be used in areas of very high humidity.	
Cleaning	Dust is removed using a dry duster or vacuum cleaner. Marks can be removed with a damp cloth using normal cleaning practices and neutral cleaning solutions. Stubborn marks and minor damages should be wiped clean prior to repainting. LINEAR: To ensure good alignment it is important that the tiles are installed in the same orientation. This is also important for maintenance when vacuuming or painting. Always ensure that when applying upward (painting) / downward (vacuuming) pressure, that the tiles are pushed / pulled in the same direction moving away from the grooved edge.	Dust is removed using a dry duster or vacuum cleaner. Marks can be removed with a damp cloth using a mild detergent if necessary. Stronger cleaning agents may be used where necessary to remove stubborn marks or where cleaning regimes require it. The product can also stand rigorous cleaning with concentrated disinfectants and detergents with high and low pH values (13.0 - 2.5).
Repair	Stubborn marks and visible damages and scratches on the surface can be repaired. Damages and scratches can be filled and finished with sandpaper prior to repainting. When painting use Knauf Danoline repair paint or similar (closest RAL colour 9003) and apply by paint roller. Spray painting is not recommended on perforated products, as there is a risk of the spray paint being applied to the acoustic felt backing thereby altering the acoustic properties.	Damages and scratches are difficult to repair and therefore it is recommended to replace damaged tiles with new.
Lamp suspension	<p>DANOTILE: For sizes up to 625x625 and min. thickness 9mm, units of up to 3kg can be installed directly into the panel without reinforcement. For larger module sizes and all sizes in 6mm thickness, a reinforcement panel of sufficient strength can be installed behind the element. The reinforcement panel must extend all the way into the main runners, so that the weight is transferred to them. The total weight should not be greater than 3kg for each m² of ceiling. Where loads are greater than 3kg/m², additional hangers must be used. Units over 3kg, should be installed independently, so that they do not place any load on the ceiling.</p> <p>BELGRAVIA, MARKANT, PLAZA, MEDLEY: For sizes up to 625x625 not in Tangent perforation, units of up to 3kg can be installed directly into the panel without reinforcement. For larger module sizes and all sizes with Tangent perforation a reinforcement panel of sufficient strength can be installed behind the element. The reinforcement panel must extend all the way into the main runners, so that the weight is transferred to them. The total weight should not be greater than 3kg for each m² of ceiling. Where loads are greater than 3kg/m², additional hangers must be used Units over 3kg, should be installed independently, so that they do not place any load on the ceiling.</p> <p>VISONA, CONTUR, LINEAR: With smaller units (of up to 3kg) a reinforcement panel of sufficient strength can be installed behind the element. The reinforcement panel must extend all the way into the main runners, so that the weight is transferred to them. The total weight should not be greater than 3kg for each m² of ceiling. Where loads are greater than 3kg/m², additional hangers must be used Units over 3kg, should be installed independently, so that they do not place any load on the ceiling.</p>	

PRODUCT CATEGORY	SELF-SUPPORTING CEILINGS	
Products	Corridor 400, Corridor Swing	Corridor F30
Surface	White painted	Foil finish
Upkeep	Designed for use under normal conditions, i.e. up to 70% RH and 25°C, e.g. in offices, institutions and similar premises. Corridor 400 and Corridor F30 have also been tested at 90% RH at 30°C and can be used under more extreme conditions such as kitchens, laboratories and rooms with frequent and major changes in the temperature and air humidity.	
Cleaning	Dust is removed using a dry duster or vacuum cleaner. Marks can be removed with a damp cloth using normal cleaning practices and neutral cleaning solutions. Stubborn marks and minor damages should be wiped clean prior to repainting.	Dust is removed using a dry duster or vacuum cleaner. Marks can be removed with a damp cloth using a mild detergent if necessary. On non-perforated tiles stronger cleaning agents may be used where necessary to remove stubborn marks or where cleaning regimes require it.
Repair	More visible damages and scratches on the surface can be repaired using filler and finishing with sandpaper prior to repainting. When painting use Knauf Danoline repair paint or similar (as NCS 0700 or closest RAL colour 9003) and apply by paint roller. Spray painting is not recommended on perforated products, as there is a great risk of the spray paint being applied to the acoustic felt backing thereby altering the acoustic properties.	Damages and scratches are difficult to repair and therefore it is recommended to replace damaged tiles with new.
Lamp suspension	<p>CORRIDOR 400: Units weighing up to 3kg can be installed directly into the panel without reinforcement. N.B. The maximum cut-out, when installing in the centre of the panel is Ø265mm / 265x265mm. Units over 3kg, should be supported independently, so that they do not place any load on the ceiling.</p> <p>CORRIDOR SWING: The ceiling tile may not bear additional weight from other installations.</p>	Objects up to a maximum of 17kg can be suspended using appropriate fixings.

UPKEEP & MAINTENANCE

Best Practice: Use of clean cotton gloves when handling painted and foil-covered product elements will ensure a good result and a ceiling without fingermarks. Handling the untreated panels with care will avoid damage and surface contamination prior to painting and thereby ensure a good end result.

PRODUCT CATEGORY	NON-DEMOUNTABLE CEILING AND WALL LININGS			
Products	Danopanel	Designpanel, Tectopanel, Solopanel, Stratopanel	Contrapanel, Adit	Kinopanel, Amfipanel
Surface	White painted	Untreated	Foil finish	Black painted
Upkeep	<p>Designed for use under normal conditions, i.e. up to 70% RH and 25°C, e.g. in offices, institutions and similar premises.</p> <p>DESIGNPANEL, TECTOPANEL: The panels have also been tested at 90% RH at 30°C and can be used under more extreme conditions such as kitchens, laboratories and rooms with frequent and major changes in the temperature and air humidity. In areas of high humidity consideration should be given to anticorrosion suspension systems and durable/washable surface finishes.</p>		<p>CONTRAPANEL: Designed for use in sports halls and similar areas where conditions do not normally exceed 70% RH and 25°C.</p> <p>ADIT: The panels are custom made and designed for use under normal conditions, i.e. 70% and 25°C, e.g. in offices, institutions and similar premises unless otherwise advised.</p> <p>Adit and Contrapanel have also been tested at 90% RH at 30°C and can be used under more extreme conditions with frequent and major changes in temperature and air humidity.</p>	<p>Designed for use in cinemas, theatres, studios and similar premises under normal conditions, i.e. up to 70% RH and 25°C.</p>
Cleaning	<p>Dust is removed using a dry duster or vacuum cleaner. Removal of marks depends on the paint used on site, although a damp cloth using normal cleaning practices and neutral cleaning solutions is normally suitable for minor marks. In the case of stubborn marks or if in doubt refer to the paint manufacturer's recommendations.</p> <p>CONTRAPANEL: Dust is removed using a dry duster or vacuum cleaner. Marks can be removed with a damp cloth using normal cleaning practices and neutral cleaning solutions. On non-perforated tiles stronger cleaning agents may be used where necessary to remove stubborn marks or where cleaning regimes require it.</p>			
Repair	<p>More visible damages and scratches on the surface can be repaired using filler and finishing with sandpaper prior to repainting. When painting use Knauf Danoline repair paint or similar (closest RAL colour 9003) and apply by paint roller. Spray painting is not recommended on perforated products, as there is a risk of the spray paint being applied to the acoustic felt backing thereby altering the acoustic properties.</p>	<p>Use a paint roller to apply paint. Use the same paint as the original surface finish chosen. Spray painting is not recommended on perforated products, as there is a great risk of the spray paint being applied to the acoustic felt backing thereby altering the acoustic properties.</p>	<p>Damages and scratches are difficult to repair and therefore it is recommended to replace damaged panels with new.</p>	<p>When painting use Knauf Danoline repair paint or similar (as NCS S9000-N) and apply by paint roller. Spray painting is not recommended on perforated products, as there is a risk of the spray paint being applied to the acoustic felt backing thereby altering the acoustic properties.</p>
Lamp suspension	<p>The tile may not bear additional weight from other installations. Light objects up to a maximum of 3 kg/m² may be installed where they can be suspended from the furring system which must be able to bear the full weight.</p>	<p>Light objects up to a maximum of 3 kg can be suspended using appropriate fixings. Items over 3 kg must be suspended from the furring system which must be able to bear the full weight.</p>	<p>CONTRAPANEL: Light objects up to a maximum of 3 kg can be suspended using appropriate fixings. Items over 3 kg must be suspended from the furring system which must be able to bear the full weight.</p> <p>ADIT: The panel may not bear additional weight from other installations.</p>	<p>The panel may not bear additional weight from other installations.</p>

PRODUCT CATEGORY	DESIGN ELEMENTS	
Products	Curvex	Mitex
Surface	Untreated	Untreated
Upkeep	<p>Designed for creating organic wall and ceiling shapes e.g. in offices, institutions and similar premises under normal conditions, i.e. up to 70% RH and 25°C.</p>	<p>Designed for creating clean-cut edges wall and ceiling shapes e.g. in offices, institutions and similar premises under normal conditions, i.e. up to 70% RH and 25°C.</p>
Cleaning	Dependent on the chosen surface finish.	
Repair	Dependent on the chosen surface finish.	
Lamp suspension	The panels are custom made and may not bear additional weight from other installations unless otherwise advised.	