

2014

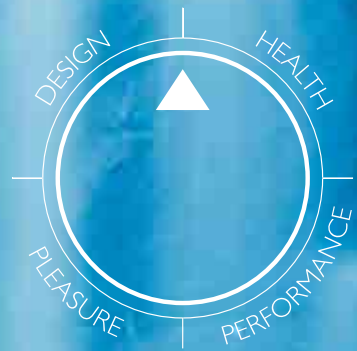

spa

hot tubs **Jacuzzi**

UK COD 220100321 - 08/2014



pleasure

design

performance

health

p. Index

- 2 The history of Jacuzzi®
- 4 The values of the Jacuzzi® brand
- 6 Jacuzzi® Hydrotherapy
- 8 Jacuzzi® PowerPro® Jets
- 10 The Jacuzzi® wellness path
- 12 ClearRay™
- 14 10 reasons to choose a Jacuzzi® hot tub
- 16 Jacuzzi respect for the environment
- 18 Understanding your Jacuzzi® hot tub

20 Jacuzzi® hot tub ranges

24 Premium

- 28 J495
- 29 J480
- 30 J470
- 31 J465
- 32 J415
- 34 JLXL Premium
- 36 JLXL
- 38 J300 Premium
- 42 J385
- 43 J375
- 44 J365
- 45 J355
- 46 J345
- 47 J335
- 48 J315
- 50 J200 Premium
- 52 J275 - J245
- 53 J235 - J210

56 Italian Design

- 60 Flow
- 61 City™ Spa
- 64 Delfi
- 65 Delos
- 66 Santorini Pro
- 67 Unique
- 68 Alimia
- 72 Profile

74 Professional

- 80 Enjoy
- 81 Virginia Experience
- 82 Sienna Experience
- 83 Alimia Experience

- 84 Rattan accessories
- 86 Wood accessories
- 88 Synthetic wood
- 90 Covers and lifters
- 92 Maintenance
- 94 After sales service

96 Specifications



When the Jacuzzi® brand became a household name

Our world renowned brand encompasses years of cutting edge design and technology and since 1956, the name has established itself as both innovator and inventor. The Jacuzzi® story is a warming tale of sheer determination and hard work. Such focus, dedication and drive were fundamentally cultivated with family at the heart. With 7 brothers, 6 sisters, 2 world wars and emigration, the founding Jacuzzi family spent their lifetime exploring new ideas and experimenting with product designs to build a business.

In 1943 Kenneth Jacuzzi developed rheumatic fever, which left him with juvenile rheumatoid arthritis. Recognising that monthly hydrotherapy sessions at hospital eased his son's symptoms, lead Candido Jacuzzi, the youngest of the 7 brothers, to develop a new hydrotherapy pump in 1956, that would give Kenneth more regular treatment at home. From that application, a small niche business developed. The family sold their portable pump, named J-300®, to hospitals and schools. The pump was later designed alongside the bath and new exclusive jet technology took the pump idea to a new level. A mix of 50% air and 50% water, turning through these special jets provided an experience like never before.



The seven Jacuzzi brothers emigrated to California from Italy. The brothers made great strides in aviation by inventing and flying the first enclosed cabin monoplane. In the 1920's their engineering skill and interest in hydraulics and the thermodynamics of fluids led them from the field of aviation to agriculture. Incorporating their hydraulic insight, the Jacuzzi family later made notable advancements in the agricultural pump industry

By the 1970's, Candido's grandson Roy Jacuzzi developed larger bathing units with built-in heating and filtration systems were introduced to accommodate groups of bathers, thus creating the first hot tub.

Today the engineering and technological advancements in hydrotherapy and jetted baths continue to flourish as new additions and ideas appear on Jacuzzi® whirlpool baths and hot tubs. We continue to anticipate your needs effectively by carrying on the Jacuzzi® tradition of style and ingenuity. In addition to being recognised as the world's largest selling brand of jetted whirlpool baths and hot tubs, Jacuzzi has over 250 worldwide patents for advancements in pump systems, jet technology, air control and product design.

Jacuzzi® brand.
More than just a name.

The foundation
of your Jacuzzi® experience



design: beautiful flowing design makes a distinctive style statement.

health: relaxing, refreshing and re-energizing supports a healthy lifestyle.



Over 50 years of invention and innovation have taught us to always keep moving. We continuously work towards uncovering the next technological discovery that will enhance the sensory experience of a Jacuzzi® hot tub. You know you're always getting the best hydromassage possible.

pleasure: pleasure is freedom to enjoy your time in any way you wish.

performance: continuous technical innovation and performance that ensure a positive experience.

A true brand experience extends beyond the use of a product. Your Jacuzzi® hot tub is not only a great place to relax and recharge every day, but its place in your busy lifestyle ensures consistent delivery of a massage experience and a revitalising journey that will inspire and transform your life.

To achieve this consistent experience, Jacuzzi prides itself on a cohesive design and product development journey that integrates our 4 brand values in every product. We define ourselves, our products and our standards by these values.

Hydrotherapy

The effects of hydrotherapy

Hydrotherapy involves the use of water for soothing an aching body or speeding the recovery of other muscular ailments. It combines water with air and heat to promote wellbeing. Water makes us buoyant, reducing our body weight by 90%. This, together with warmth, greatly eases stress on the body's muscles and joints.

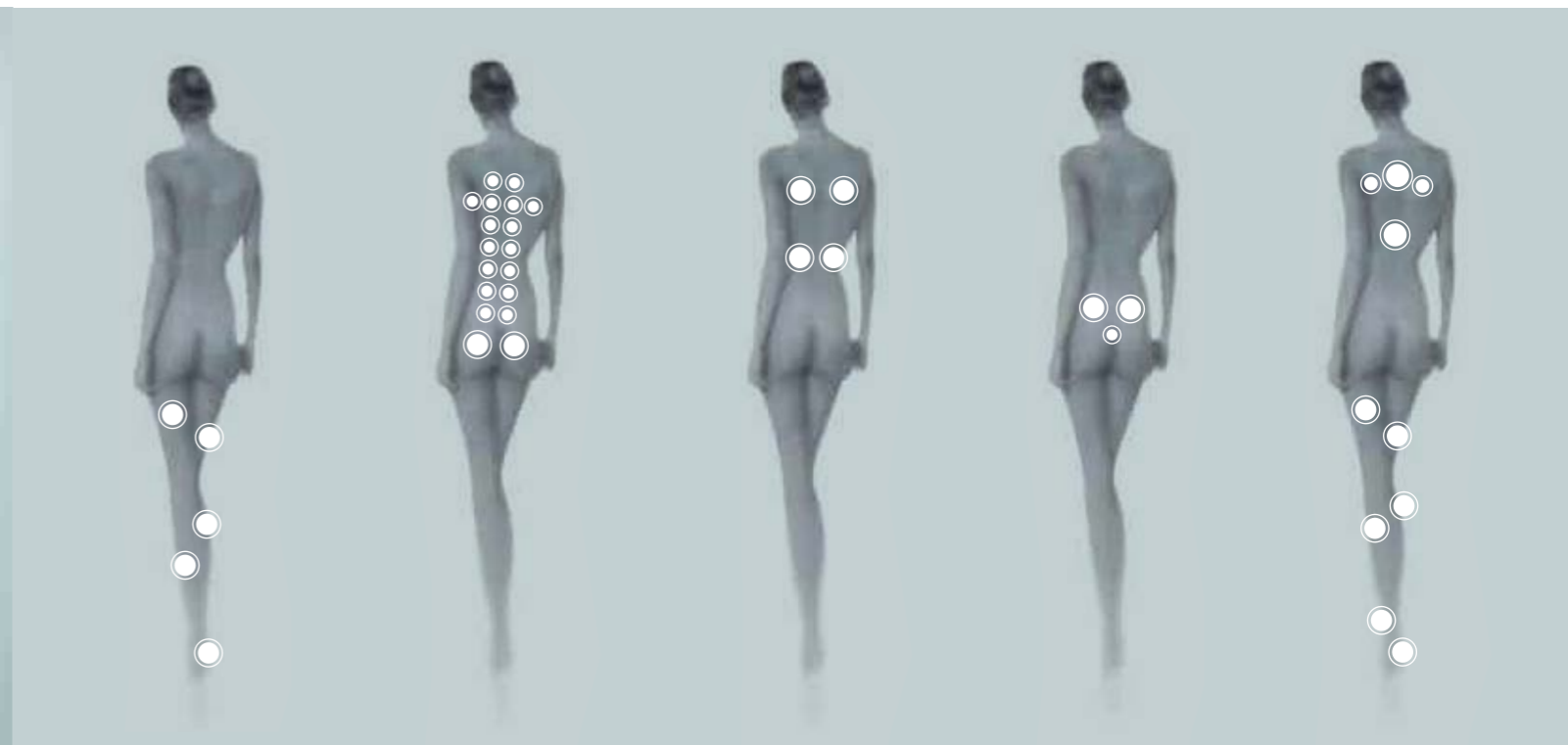

How it works

In warm water, the heat dilates our blood vessels improving blood to flow to sore or damaged tissue. Our muscles relax, our circulation improves and the weightlessness helps us lose the tension we've unconsciously been carrying around all day. Warm water is used in physiotherapy to speed recovery from injuries and relieve muscle soreness. From a targeted stream for deep tissue massage to relaxing micro bubbles, Jacuzzi PowerPro® jets give you a variety of hydrotherapeutic massage types that improve circulation and promote the flow of endorphins.

A great hot tub massage includes hot tub jets that are the right size for a specific muscle group with the appropriate intensity. All Jacuzzi PowerPro® jets are made to direct water flow. You can customise a massage by controlling the flow. Divert water flow pressure from one seat to the next and turn the hot tub jets off and on individually to personalise your massage. A rotating stream of water and air replicates a hand circling or rubbing certain areas of your back for a smooth massage.

Who can benefit

Massage alone is proven to reduce stress, calm anxiety, enhance sleep quality and improve concentration; as well as aiding in other physiotherapy and recovery programmes. Hydrotherapy massage is not an alternative for medical massage treatments, but it is easily carried out at home and can be used to support a healthy active lifestyle. Warm water therapy in a Jacuzzi® hot tub works for people of all shapes, sizes and stress levels. Some people need a pulsating, strong jet stream for working knots out of large muscles. Others crave a soothing warm water retreat that clears the mind as it relaxes the body. The benefits of hydrotherapy could go even further as it is thought to help ease symptoms of arthritis whilst also providing temporary relief from chronic pain and promoting better sleep.

Jacuzzi® PowerPro® Jets

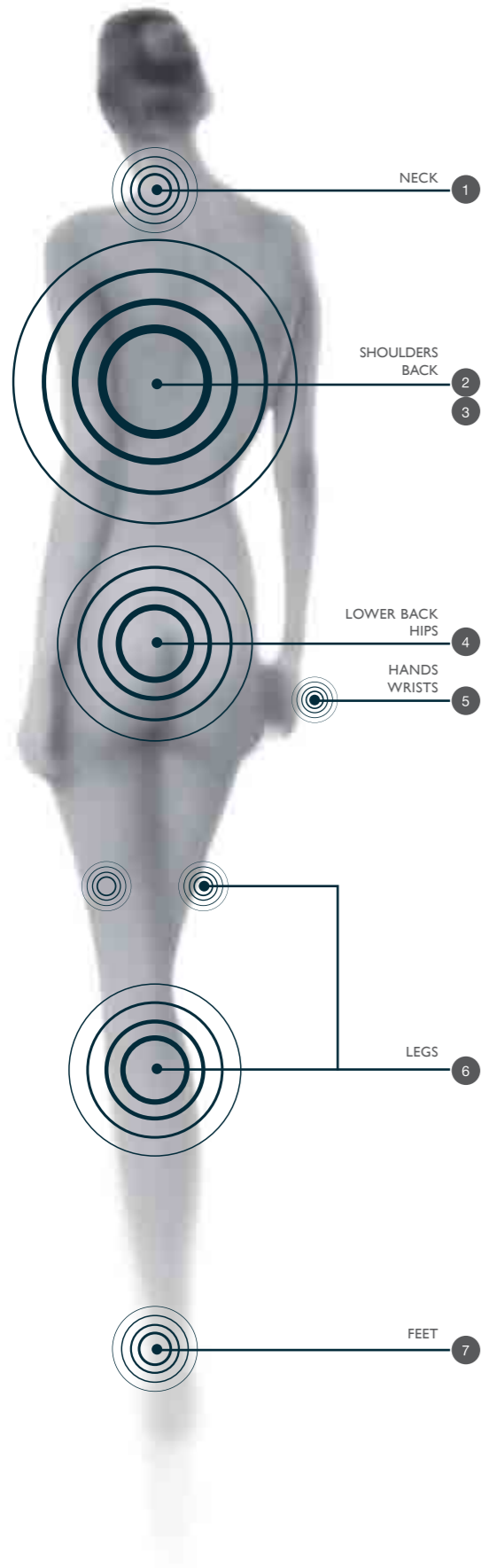

PowerPro® MX Jets

This is the original Jacuzzi® jet, perfected. Virtually every jet manufactured today is based on this unique and innovative design. Our PowerPro® MX Jets deliver the maximum volume of water per minute - more than any other jet available today. The big, bold massage action of the MX Jet feels comforting as it works deeply to soothe tired and sore muscles.

Stimulates:

- 1 Neck area
- 2 Shoulders and back
- 3 Lower back
- 4 Hips
- 5 Hands and wrists
- 6 Legs
- 7 Feet



PowerPro® FX jets

Jacuzzi® PowerPro® FX jets' unique spiral action sends an energetic stream of air and water that's perfect for smaller muscle groups. Adjustable to high and low pressure, FX jets relieve tension at pressure points in the shoulders, neck, back, calves and feet.

Stimulates:

- 1 Neck area
- 2 Shoulders and back
- 3 Lower back
- 4 Hips
- 5 Hands and wrists
- 6 Legs
- 7 Feet



PowerPro® MX2 Jets

Based on the form and function of the original Jacuzzi jet created 50 years ago, the new generation, patented, MX2 jets deliver maximum volume at a higher air-to-water ratio. PowerPro® MX2 jets are strategically located to deliver a bold massage, especially effective for muscles in the lower back.

Stimulates:

- 1 Neck area
- 2 Shoulders and back
- 3 Lower back
- 4 Hips
- 5 Hands and wrists
- 6 Legs
- 7 Feet



PowerPro® FX Small Jets

Based on the FX technology, the FX Small Jets are perfect for a focused massage on key pressure point areas, such as your feet. The jets are adjustable, making it easy for a perfect foot massage.

Stimulates:

- 1 Neck area
- 2 Shoulders and back
- 3 Lower back
- 4 Hips
- 5 Hands and wrists
- 6 Legs
- 7 Feet



PowerPro® RX Jets

The spinning action of the patent-pending PowerPro® RX jet is fully adjustable. Simply turn the dial on the face to customise the pressure or turn off the jet action entirely. Modest in size, the RX jet covers a sizable area, reaching the key muscles and nerves of the back for a pampering massage.

Stimulates:

- 1 Neck area
- 2 Shoulders and back
- 3 Lower back
- 4 Hips
- 5 Hands and wrists
- 6 Legs
- 7 Feet



PowerPro® FX Rotational

Using the same FX technology, the new PowerPro® FX rotational jet focuses on smaller muscle groups with a kneading effect to stimulate surrounding tissue.

Stimulates:

- 1 Neck area
- 2 Shoulders and back
- 3 Lower back
- 4 Hips
- 5 Hands and wrists
- 6 Legs
- 7 Feet



PowerPro® IX Jets

This illuminating jet creates a dramatic impact. Maximum airflow is combined with high-output LED lighting to create a unique, champagne bubble effect as the effervescent light is carried by the bubbles to the water's surface.

Stimulates:

- 1 Neck area
- 2 Shoulders and back
- 3 Lower back
- 4 Hips
- 5 Hands and wrists
- 6 Legs
- 7 Feet



PowerPro® FX Large Rotational Jets

The FX Large Rotational Jet has a wide swath that provides an exceptional massage for large muscles. A stainless steel centre shaft ensures non-corrosive and long term performance.

Stimulates:

- 1 Neck area
- 2 Shoulders and back
- 3 Lower back
- 4 Hips
- 5 Hands and wrists
- 6 Legs
- 7 Feet



PowerPro® NX2 Jets

Advanced NX2 jets effectively relieve tension and strain in the sensitive (and hard to reach) neck area with a highly focused stream of water. Change direction by adjusting the nozzle and intensity of the massage by turning the jet face.

Stimulates:

- 1 Neck area
- 2 Shoulders and back
- 3 Lower back
- 4 Hips
- 5 Hands and wrists
- 6 Legs
- 7 Feet



PowerPro® FX Large

The PowerPro® FX Large jets focuses on the middle of the back relieving tension and muscle strain, typically caused by poor posture. The FX Large jet gives a spiral action massage to the back promoting better circulation.

Stimulates:

- 1 Neck area
- 2 Shoulders and back
- 3 Lower back
- 4 Hips
- 5 Hands and wrists
- 6 Legs
- 7 Feet



PowerPro® PX Jets

The PX jets provide a gentle pulsating massage that can be adjusted in strength to suit your needs. It is perfect for smaller muscle groups including the wrists and hands.

Stimulates:

- 1 Neck area
- 2 Shoulders and back
- 3 Lower back
- 4 Hips
- 5 Hands and wrists
- 6 Legs
- 7 Feet



PowerPro® BX Jets

Often used in Jacuzzi® lounge seats, these unique jets offer a very high ratio of air to water for a softer, soothing effect across your calves.

Stimulates:

- 1 Neck area
- 2 Shoulders and back
- 3 Lower back
- 4 Hips
- 5 Hands and wrists
- 6 Legs
- 7 Feet

The path to wellness

The seats in a Jacuzzi® hot tub are designed to offer a wellness program, which ensures delivery of an effective all over massage. Detailed below are the massage effects at each stage of the wellness path:



- 1° Dive in and enjoy a moment's rest in the entrance, letting your legs sink further into the soothing warm water. You can choose to enjoy the pleasure of aromatherapy. The relaxing trickling of the waterfall in the background will help you escape the rush of everyday life. Activate the circulation pump and begin relieving the lower joints.
- 2° Now sit completely in the tub. The first session, counterclockwise, gently massages your back, focusing on the shoulders and lumbar areas. Your blood circulation is stimulated, muscles and joints loosen as the level of stress and tension is released from your body.
- 3° The next corner is a favourite. Here, the massage becomes more energetic, the jets are stronger and larger, able to effectively improve muscle tone. The jets' action rotates water flow, which improves circulation and the look of your skin.
- 4° Feel the full power of the circulation pump as you sit in the corner of your hot tub opposite the entrance. Enjoy a vigorous massage that spreads across the whole of your back, losing stiffness and relaxing the muscles.



- 5° As the wellness path reaches its peak, your muscles are unwinding and the massages start to get softer. Your stress is diminishing and your body is feeling more refreshed and stimulated.
- 6° Finally, the therapy lounge seat. In this position feel the combination of relaxing back jets with 2 rows of smaller jets that deliver a delicate massage up and down your hamstrings and calves like fingers. The jets in the footwell also invigorate your feet and ankles.
- 7° Now, with the massage jets turned off, take a moment to enjoy the peaceful warmth of the water and feel the tingly effects of your hydrotherapy massage. Fold your shoulders into the watery blanket one last time and submerge yourself in comfort.

ClearRay™

innovative peace of mind

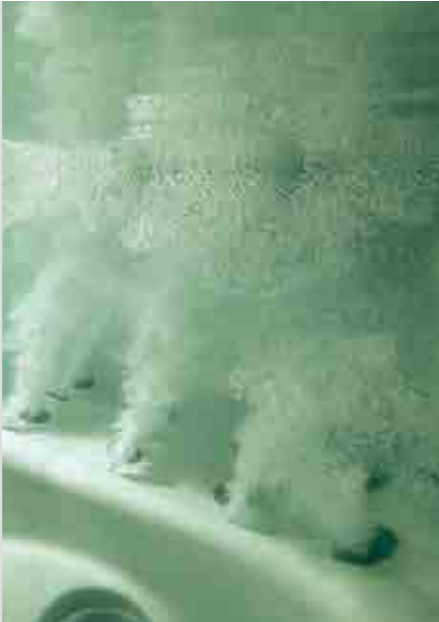

Without CLEARRAY™



With CLEARRAY™



The ClearRay™ system, standard on all Jacuzzi® hot tubs represents an evolution in water treatment. UV light has been used for years as a reliable water disinfectant. The light effectively interacts with the DNA of bacteria and viruses, destroying their ability to reproduce. It is a natural process that adds no by-product to your water. Simply designed with a long lasting, low pressure UV-C lamp and integrated in the hot tub filtration process, ClearRay treats 99.9% of waterborne pathogens. Sanitising begins in seconds, giving you crystal clear water instantly.

10 reasons to choose a Jacuzzi® hot tub

1. Spend more time with your family.

Spending quality time together as a family or a couple is one of the biggest benefits to having a Jacuzzi® hot tub in your life. Playing games or chatting to loved ones in your garden, away from the pressures of every day, really helps you appreciate the little things in life that truly matter.



2. Unwind after a full day

There's nothing more comfortable or soothing after a busy day than sinking into a warm bath of bubbly water. All your muscles relax into the warmth and our exclusive Jacuzzi® jets of water and air gently target your aching joints with a comforting massage. Help your body and mind relax properly at the end of the day.

3. Recharge and boost your energy

A regular full body massage promotes better circulation by increasing blood flow around your body. Hydrotherapy massage from a Jacuzzi® hot tub is flexible, so you can control the direction and amount of pressure, making your massage as soothing or as penetrable as you need. A healthy body is an energetic, active one and a Jacuzzi® hot tub can really support your healthy lifestyle.

4. Increase your energy, not your energy bills.

Running a hot tub can be expensive if it isn't insulated enough to maintain heat. Jacuzzi® hot tubs use innovative, latest technology and components to keep our tubs insulated better than most on the market. Jacuzzi® hot tubs boast up to four different layers of insulation. This keeps heat in more effectively and reduces running costs significantly.

5. Keep your water cleaner for longer

Hot tub water must be kept clean and safe for use. Water should circulate throughout the day to avoid it becoming stagnant. All Jacuzzi® hot tubs have programmable circulation and filtration cycles. As it circulates, the water in a Jacuzzi® hot tub is also cleaned as it passes through our ClearRay™ UV technology as well as our filtration systems. We'll save you time and effort on maintaining your Jacuzzi® hot tub by keeping it moving and filtered while it is out of use – this doesn't add to your running costs either.

6. Your Jacuzzi® hot tub will last for years!

Look inside a Jacuzzi hot tub and it is like looking under the bonnet of a luxury car. We believe in providing you the best hot tub experience and do not compromise on quality by using cheaper parts. We know you will enjoy your Jacuzzi® hot tub for years to come and we want you to have total faith in its ability. Our high standards and keen attention to detail means that we've done the hard work for you, you can relax.

7. We're here for you

Our priority is making sure your Jacuzzi® hot tub experience is better than you expect. From your first visit to one of our retailers' showrooms, through doing your research, choosing your favourite Jacuzzi® hot tub, getting it installed and even 10 or 20 years later, we want you to be proud of choosing the best: Jacuzzi®. We offer a manufacturer's guarantee for all our hot tubs for your peace of mind. A Jacuzzi® hot tub will help your life flow smoother, and so will our back up service.

8. We have over 50 years experience

The Jacuzzi family have been making hot tubs since the 1960's – in fact they designed and launched the first one! Since then, our technicians have designed and patented hundreds of new ideas and technologies. We know about hot tubs. We love hydrotherapy. We listen to our customers and use their valuable feedback to keep on building new features and better designs.

9. You already know our brand

Jacuzzi® is a brand name. Finding out that we're actually a family brand is good news. You already know which brand to trust. Whenever you want to learn more about hot tubs, hydrotherapy or investing more time into your own or your family's well being, you know who to turn to first.

10. We work with associations.

Being the market leader in hydrotherapy products, we stay close to our industry associations. We provide them with our experience and support in creating a stable foundation for selling hot tubs.

Respect for the environment

- All wood used in our hot tub comes from suppliers supporting environmental management systems.
- Backing materials on our cabinets are made from at least 80% recycled plastics.
- LEDs in our hot tubs use approximately 8% of the energy used by a comparable incandescent bulb.
- Our SmartSeal™ insulation system is made from recycled blue jeans.
- Jacuzzi® J-LXL is made with 1.5" of high density, heat-retaining backing as well as our standard insulation materials, making it the most energy efficient hot tub in its class.



The essence of our brand strength lies with our integrity. We do our utmost to bring an excellent service to all of our customers. We take responsibility for our actions along the way. For example;

- The Jacuzzi® hot tub factory is a leading modern facility, utilising a Thermal Regenerative Oxidiser during production; a greener practice that neutralises 99% of off-gasses that might ordinarily be released into the environment.
- We have built a closed loop system to recycle virtually all the water we use for testing our hot tubs.
- Excess acrylic from our hot tub shells is ground down and recycled for other products such as industrial cleaning agents.
- Our electronics do not contain lead and are non-toxic. This allows for safe disposal at the end of their lifecycle.

Understanding your Jacuzzi® hot tub

Where should I place my hot tub?

Not only is a Jacuzzi® hot tub great for your lifestyle, it also looks fantastic as a garden feature. There are a couple of considerations to be aware of before you plan a hot tub in your garden design. For example, have you left enough space around it for steps, covers and other hot tub accessories? Have you left sufficient access for upgrades or repairs to the elements inside your hot tub? What will your hot tub sit on?



The base needs to be set on a level foundation, not straight onto grass. If your hot tub is going indoors don't forget that you need sufficient ventilation too.

Who does the installation?

When you purchase a Jacuzzi® hot tub, our main priority is getting you to sit back and relax in your new hot tub at home. We'll help you decide where to put it, work out how to get it there, deliver it and install it for you. We'll get everything set up and running so you can jump straight in. Our team will even show you how to use your new hot tub and explain about keeping the water clean and safe.

How often will I need to replace the water?

A hot tub needs to be drained and re-filled up to 4 times a year. If it is well looked after and the water chemistry is managed effectively, the need to drain and refill is less frequent.

Can you use the spa in winter?

Yes, Jacuzzi® hot tubs are extremely well insulated and the water temperature is maintained throughout the year. Many customers tell us that the Jacuzzi hot tub experience is better in the colder weather.

Are the running costs of a Jacuzzi® hot tub expensive?

Jacuzzi® hot tubs remain connected to the mains, keeping water warm all year. But don't worry, high quality Jacuzzi® hot tubs have several features that keep running costs to a minimum. These include our unique Trifusion™ acrylic shell, 2 layers of insulating foam plus our new SmartSeal™ wrap on some models. Our J-LXL model is most efficient hot tub in its class, with high density insulation tucked in around all sides and the base. We've included kW ratings for all our hot tubs so you can work out running costs based on the cost of energy in your area.

Is a Jacuzzi® hot tub difficult to maintain?

Maintaining a Jacuzzi® hot tub is easy. Depending on your use, your hot tub will need refilling and cleaning 3-4 times a year. On top of that, your filters will need cleaning regularly and your hot tub water will need treating every day with a small amount of chemicals.

How do you operate the different functions?

All Jacuzzi® hot tub features are managed from an integrated control panel that is conveniently placed and easy to use. The control panel helps you manage the temperature, the lighting, the waterfall and your music system. Some Jacuzzi® hot tubs include a floating remote control.

Does a Jacuzzi® hot tub have a warranty?

Yes, every Jacuzzi® hot tub has at least a standard 2 year warranty included.

J400	JLXL	J300		J200
p. 28 J495	p. 36 JLXL	p. 42 J385	p. 47 J335	p. 52 J275 - J 245
p. 29 J480		p. 43 J375	p. 48 J315	p. 53 J235 - 210
p.30 J470		p. 44 J365		
p. 31 J465		p. 45 J355		
p. 32 J415		p.46 J345		

premium



p. 60 flow	p. 67 unique
p. 61 city spa	p. 68 alimia
p. 64 delfi	p. 72 profile
p. 65 delos	
p. 66 santorini pro	

italian design



p. 80 enjoy
p. 81 virginia experience
p. 82 sienna experience
p. 83 alimia experience

professional



All our spa baths, seat by seat

premium

♣x2

♣x3

♣x4

♣x5

♣x6

♣x7

♣x8



p. 32
J415
seating capacity 2-3



p. 53
J210
seating capacity 4



p. 31
J465
seating capacity 4-5



p. 29
J480
seating capacity 6



p. 46
J345
seating capacity 5-6



p. 45
J355
seating capacity 5-6



p. 30
J470
seating capacity 6-7



p. 28
J495
seating capacity 7-8



p. 48
J315
seating capacity 3



p. 47
J335
seating capacity 4-5



p. 43
J375
seating capacity 6



p. 44
J365
seating capacity 6



p. 52
J275
seating capacity 6



p. 42
J385
seating capacity 6-7



p. 52
J245
seating capacity 6-7



p. 36
JXL
seating capacity 5



p. 53
J235
seating capacity 6

italian design



p. 60
flow
seating capacity 2



p. 61
city spa
seating capacity 2



p. 67
unique
seating capacity 3



p. 65
delos
seating capacity 4



p. 64
delfi
seating capacity 4



p. 66
santorini pro
seating capacity 5



p. 68
alimia
seating capacity 5-6



p. 72
profile
seating capacity 5-6

professional



p. 80
enjoy
seating capacity 6



p. 81
virginia experience
seating capacity 6-7



p. 83
alimia experience
seating capacity 6-7



p. 82
sienna experience
seating capacity 7-8



⋈x3



p. 32
J415
seating capacity 2-3

⋈x5



p. 31
J465
seating capacity 4-5

⋈x6



p. 29
J480
seating capacity 6

⋈x7



p. 30
J470
seating capacity 6-7

⋈x8



p. 28
J495
seating capacity 7-8

Sit in a J400 hot tub and you'll feel extra special in minutes. These are hot tubs that will look after you and your body, treating you with a relaxing massage in the warmth. Impress your friends and invite them to try out your Jacuzzi® experience – there is no other hot tub experience like it!

J400 premium

J400

premium

Space for entertainment

All J400 series hot tubs are equipped with J-1000 LED screen control system. Simple and intuitive, it supports the exclusive BLUEWAVE™ Spa Stereo System which has a 10 metre Bluetooth connection, allowing you to manage your own playlists on your iPhone and iPod directly from the hot tub's display. In addition, it is provided with USB port, MP3 stereo and FM radio for you to immerse yourself fully in wellness, nurtured by your favourite music.



All functions can be operated and adjusted via the J-1000 control system with its illuminated LED panel. With a simple touch of your finger, you have complete control over the temperature and jets and you can store your favourite settings. You can also activate the "Eco Mode" function which allows you to control your energy consumption based upon frequency of use. You can also lock your settings.

The best hydromassage.

The Jacuzzi® PowerPro® System drives all of the jet action, soft or strong, with low-pressure, high volume pumps. Different muscle groups demand different types of massaging jet action. Each of the versatile jets in the J-400 range offers a full range of massages, from robust and stimulating to gentle and rejuvenating. Selected adjustable jets let you control the way they perform just by turning their jets individually to suit you.

Conserving energy

SmartSeal™ is available on all J-400 hot tubs. Made from recycled blue jeans, this environmentally friendly solution achieves up to 20% reduction in energy use and protects from moisture, mold and reduced noise.

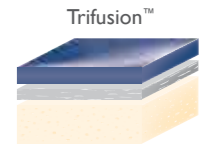

Beautiful Watercolour™ Waterfalls

The graceful raised profile design creates a dramatic cascade of water. Sit under the Watercolour™ waterfall and enjoy a soothing neck and shoulder massage.

Simple and immediate maintenance

The ProClarity™ system works together with the recirculation pump to achieve a high performance filtering system. The Logo Indicator Light intuitively displays any anomalies in the tank operation: white light - normal operation, red light - maintenance activity required.

Wrapped in a special shell

Jacuzzi® has created the special Trifusion™ shell, that is a tri-layer acrylic, vinyl ester vapour barrier and resin composite combined together, making the hot tub shell the strongest in the industry. A solution that guarantees both energy saving and solidity of structure.

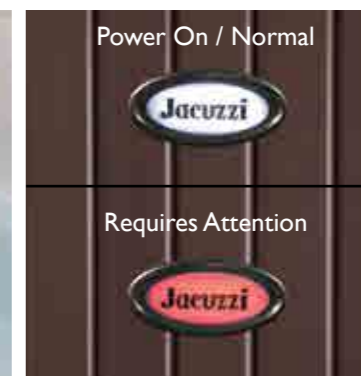

J495

Space and uncompromising performance: comfortably seats up to 9 persons.



229 x 279 x 104(115)H cm



62 POWERPRO® JETS

- MX2 3
- FX 18
- RX 11
- IX 1
- NX2 10
- FX small 8
- FX rotational 6
- FX large rotational 5

- x8-9
- Water capacity 2574 L
- Blue Wave Stereo System (optional)
- ClearRay™
- 2 Waterfalls with lights
- Multicolor

J480

Exclusive design, with curved and asymmetric lines and large capacity.



239 x 239 x 99(112)H cm



52 POWERPRO® JETS

- MX2 3
- PX 6
- FX small 8
- FX rotational 6
- FX large rotational 5
- FX 12
- RX 6
- IX 1
- NX2 4

- x6 (1 lounge)
- Water capacity 2271 L
- Blue Wave Stereo System (optional)
- ClearRay™
- 2 Waterfalls with lights
- Multicolor



J470

Comfort comes in your size, with seats in a variety of depths



231 x 231 x 99(112)H cm



43 POWERPRO® JETS

- MX2 3
- FX 10
- RX 6
- IX 1
- NX2 4
- FX small 8
- FX rotational 6
- FX large rotational 5

- x6-7
- Water capacity 2120 L
- Blue Wave Stereo System (optional)
- ClearRay™
- 2 Waterfalls with lights
- Multicolor

J465

6 seats, including a lounge seat, designed to offer unparalleled comfort and wellness.



224 x 224 x 99(112)H cm



39 POWERPRO® JETS

- MX2 5
- FX 6
- PX 4
- FX rotational 6
- FX large rotational 7
- RX 6
- IX 1
- NX2 4

- x6 (1 lounge)
- Water capacity 1931 L
- Blue Wave Stereo System (optional)
- ClearRay™
- Waterfall with lights
- Multicolor



J415

3 seats including a lounge seat:
a blend of experience and quality.



193 x 168 x 81H cm



x3
(1 lounge)



Water capacity
1098 L



Blue Wave
Stereo System
(optional)



ClearRay™



Waterfall
with lights



Multicolor



21 POWERPRO® JETS

FX
9



RX
5



NX2
2



FX
rotational
4



FX
large
rotational
1





λx5



p. 36
JLXL
seating capacity 5

You can see the Jacuzzi® difference a mile away. But get in and feel it, you'll be amazed at how wonderful you'll feel afterwards. Go on, let go and enjoy the benefits of a true Jacuzzi® hot tub hydromassage. The J-LXL delivers a wonderful massage tailored to your needs; divert the jets to your liking, control the pressure, the power is at your fingertips.

JLXL premium

JLXL

Minimalist look for the hot tub with the best energy coefficient based upon performance.



213 x 213 x 91H cm



x5
(1 lounge)



Water capacity
1839 L



Blue Wave
Stereo System



ClearRay™



Waterfall



Multicolor



38 POWERPRO® JETS

MX2
2



FX
23



RX
4



NX2
6



FX
large
rotational
3





人x3



p. 48
J315
seating capacity 3

人x5



p. 47
J335
seating capacity 4-5

人x6



p. 46
J345
seating capacity 5-6



p. 44
J365
seating capacity 6



p. 42
J385
seating capacity 6-7



p. 45
J355
seating capacity 5-6



p. 43
J375
seating capacity 6

Smile inside, knowing that warming constant in your life is sat waiting patiently for you in your garden. Come home after a long day at work or a tough workout and take yourself off to a luxury destination of your choice, without leaving your home. Now you really can holiday at home.

J300 premium

J300

NEW

premium



New Premium Design

The aesthetics of all J300 models have been lightened, refreshed and projected to a dimension of modernity. From the cutting-edge aesthetics of the filtering grid, to the filter shell, to the luminous and comfortable headrests, to the cover of the waterfall jet, every detail enhances the linearity and cleanliness of the lines.

New control panel

All J300 hot tubs have a new control system with LED touch-screen display. The renewed aesthetics and cutting-edge technology make it a fully-fledged design icon consistent with the new philosophy of the line. Even simpler and more intuitive, all its functions can be activated with a simple touch of your finger, including the ClearRay Jacuzzi® cleaning system and the exclusive BLUEWAVE™ Spa Stereo System.

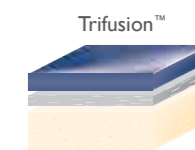

Space for entertainment

All J300 series hot tubs support a new generation audio system: BLUEWAVE™ Spa Stereo System has a 10 metre Bluetooth connection, allowing you to manage your own playlists on your iPhone and iPod directly from the hot tub's display. In addition, it is provided with USB port, MP3 stereo and FM radio for you to immerse yourself fully in wellness, nurtured by your favourite music.

Coating and shell

In addition to 3 layer insulation, we have also added SmartSeal™. Ideal for cold climates, this system also reduces noise and prevents the formation of mould and moisture. With SmartSeal™ you can save approximately 25% on your bills.

A completely renewed Premium series

Major renewals and improvements in the J300 collection. The line boasts a more modern and functional design and new jets across all models which enhance and improve the performance of the hydro-massage. The aesthetics are charmingly enhanced thanks to new colours, while the controls become even simpler and more straightforward to manage thanks to a new control system.

The new Power Pro® Therapy Seats

It is hard to improve upon perfection, but Jacuzzi® has managed it with the new seats of the J300 hot tubs. Thanks to the positioning and power of the jets, they offer an even more effective hydro-massage at the key nerve centres of the back and lumbar region. As well as enhancing its performance, Jacuzzi® has positioned a higher number of jets, especially in the lounge seats: from the neck to the shoulders, legs and feet, every area of the body is stimulated and massaged in-depth by a rotating and targeted jet which relieves tension, generating wellness.

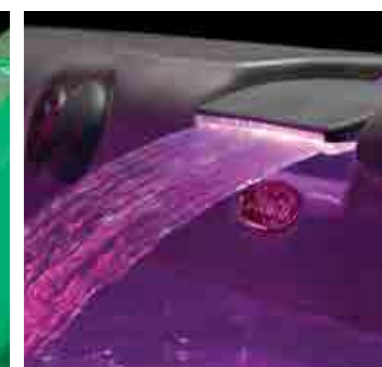

J385



A new dimension of functionality and design.



231 x 231 x 96H cm



49 POWERPRO® JETS

- MX 3
- FX 17
- NX2 8
- FX small 4
- FX rotational 7
- FX large rotational 4
- FX large 4
- BX 2

x6-7



Water capacity 2196 L



Blue Wave Stereo System (optional)



ClearRay™



Waterfall with lights



Prolites System



Unmistakeable style for an experience of total wellness.



J375



231 x 231 x 96H cm



50 POWERPRO® JETS

- MX 5
- FX 18
- NX2 4
- FX large 2
- BX 12
- FX rotational 6
- FX large rotational 3



x6 (1 lounge)



Water capacity 2196 L



Blue Wave Stereo System (optional)



ClearRay™



Waterfall with lights



Prolites System



J365

NEW

A fantastic family tub featuring four therapy seats but with 6 seats in total.



231 x 213 x 97H cm



44 POWERPRO® JETS

- MX 3
- FX 19
- NX2 4
- FX small 8
- FX rotational 4
- FX large rotational 3
- FX large 3

- x6
- Water capacity 1893 L
- Blue Wave Stereo System (optional)
- ClearRay™
- Waterfall with lights
- Prolites System

A compact design with top functions and accessories to customise your hydromassage.

NEW

J355



231 x 213 x 97H cm



42 POWERPRO® JETS

- MX 5
- FX 14
- NX2 2
- FX large 2
- BX 12
- FX rotational 4
- FX large rotational 3

- x5-6 (1 lounge)
- Water capacity 1855 L
- Blue Wave Stereo System (optional)
- ClearRay™
- Cascade with lights
- Prolites System



J345



An all seater social spa to enjoy with friends and family.



213 x 213 x 91H cm



40 POWERPRO® JETS

- MX 3
- FX 19
- NX2 4
- FX small 8
- FX rotational 4
- FX large rotational 3
- FX large 2

x5-6 (1 lounge)



Water capacity 1741 L



Blue Wave Stereo System (optional)



ClearRay™



Waterfall with lights



Prolites System



The hot tub with FX10 Therapeutic Seat for a complete wellness treatment.



J335



213 x 213 x 91H cm



40 POWERPRO® JETS

- MX 2
- FX 16
- FX rotational 4
- FX large rotational 4
- BX 12
- FX large 2



x4-5 (1 lounge)



Water capacity 1704 L



Blue Wave Stereo System (optional)



ClearRay™



Cascade with lights



Prolites System



J315

NEW

All the benefits of a large hot tub, concentrated into a small space.

x3
(1 lounge)



Water capacity
1089 L



Blue Wave
Stereo System
(optional)



ClearRay™



Waterfall
with lights



Prolites System



21 POWERPRO® JETS

193 x 168 x 81H cm

- FX 8 
- FX rotational 2 
- FX large rotational 5 
- BX 6 





♣x4

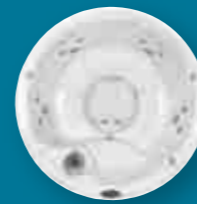

p. 53
J210
seating capacity 4

♣x6



p. 53
J235
seating capacity 6



p. 52
J275
seating capacity 6

♣x8



p. 52
J245
seating capacity 6-7

If you are looking for the reliability and quality offered by a Jacuzzi® Premium Spa at a convenient price, the J200 line is your ideal solution. 4 models with a clean-cut design and the essential accessories, offer versatility to meet all installation requirements, while guaranteeing good quality performance. A great way to introduce yourself to the Jacuzzi® brand, hours of fun for your family or yourself lie ahead.

J200 premium

J275



228 x 228 x 91H cm

45 CLASSIC JETS

x6
(1 lounge)



Water capacity
2006 L



Blue Wave
Stereo System
(optional)



ClearRay™



Waterfall



Classic
10 LED



213 x 213 x 91H cm

35 CLASSIC JETS



J235

x6
(1 lounge)



Water capacity
1741 L



Blue Wave
Stereo System
(optional)



ClearRay™



Waterfall



Classic
10 LED



J245



213 x 213 x 91H cm

35 CLASSIC JETS

x6-7



Water capacity
1779 L



Blue Wave
Stereo System
(optional)



ClearRay™



Waterfall



Classic
10 LED



Ø 198 x 91H cm

19 CLASSIC JETS



J210

x4



Water capacity
1173 L



ClearRay™















Waterfall



Multicolor



Colours and Finishings

			J495	J480	J470	J465	J415	JLXL	J385	J375	J365	J355	J345	J335	J315	J200 series
shell colours	platinum		●	●	●	●	●	●	●	●	●	●	●	●	●	●
	desert sand		●	●	●	●	●									
	silver pearl		●	●	●	●	●	●	●	●	●	●	●	●	●	
	opal			●	●	●	●	●	●	●	●	●	●	●	●	
	midnight			●	●	●			●	●	●	●	●	●		
	caribbean surf			●	●	●			●	●	●	●	●	●		
	slate green			●	●	●			●	●	●	●	●	●	●	
synthetic wood	brazilian teak		●	●	●	●	●	●	●	●	●	●	●	●	●	
	silver wood		●	●	●	●	●		●	●	●	●	●	●	●	●
	roasted chestnut			●	●	●	●	●	●	●	●	●	●	●	●	●
covers	bordeaux (leatherette)		●	●	●	●	●	●	●	●	●	●	●	●	●	●
	silver wood (leatherette)		●	●	●	●	●		●	●	●	●	●	●	●	●

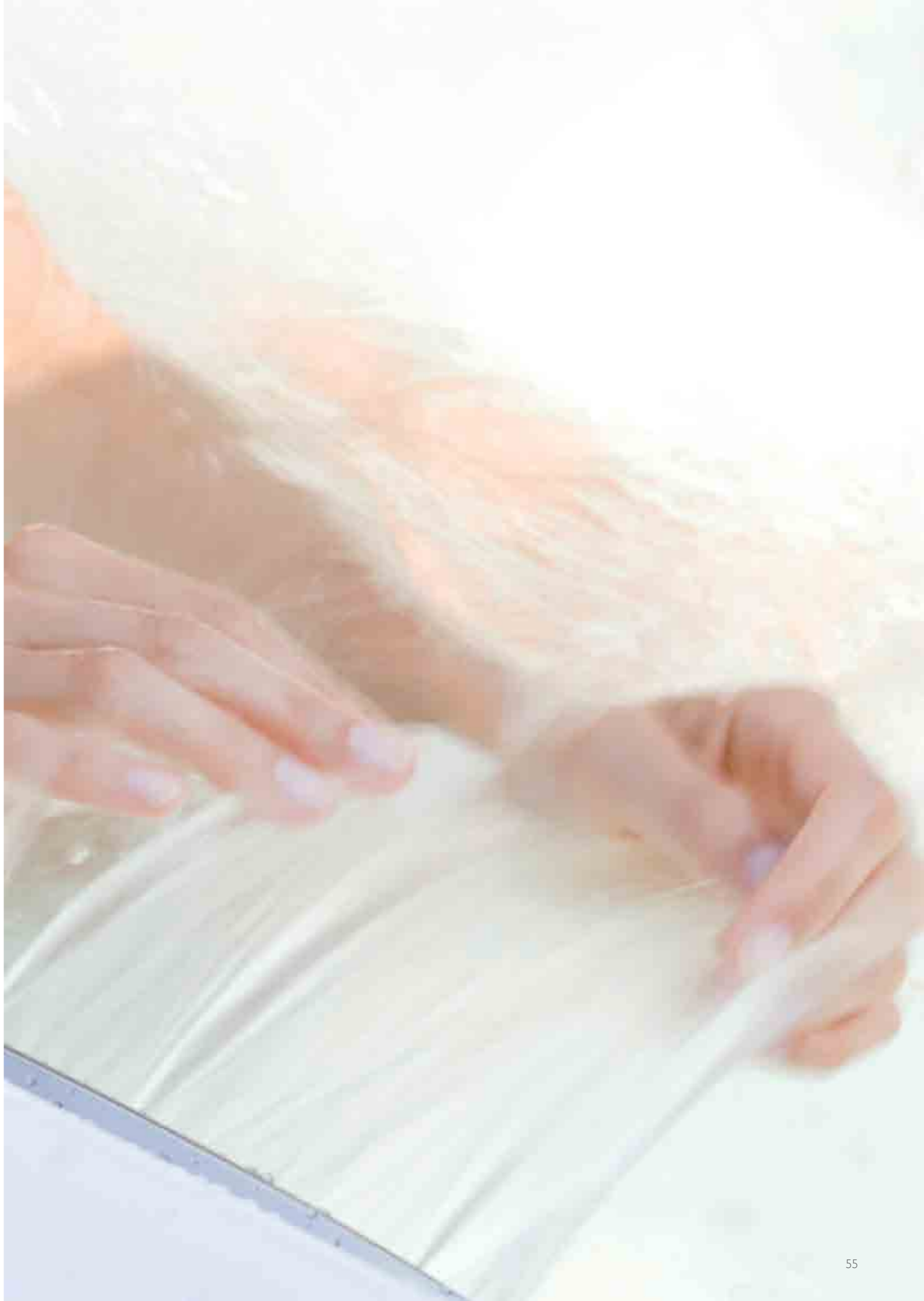



2



p. 60
flow
seating capacity 2



p. 61
city spa
seating capacity 2

3



p. 67
unique
seating capacity 3

4



p. 64
delfi
seating capacity 4



p. 65
delos
seating capacity 4

5



p. 66
santorini pro
seating capacity 5

6



p. 72
profile
seating capacity 5-6

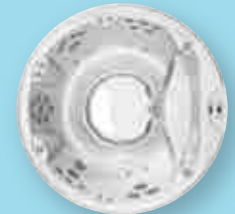

p. 68
alimia
seating capacity 5-6

The Italian Design range demonstrates the depth of our design process. See our journey come to life as sleek sophisticated curves fuse with contemporary colour and Jacuzzi® hydrotherapy expertise. Enjoy your exclusive Jacuzzi® hot tub experience knowing how our designers have blended the best in hydrotherapy with the best in iconic design. This is Jacuzzi® innovation wrapped up as exquisite garden furniture.

italian design

flow city spa

italian design



Simple and intuitive commands

The LED digital control panel on the top edge of the hot tub is a jewel of technology and design. With a simple touch of your finger, you can activate and select all the hot tub functions simply and intuitively. It thus acts as a fully-fledged wellness unit.

Say farewell to impurities

The filtering system is equipped with a skimmer to remove impurities present on the surface of the water. The ClearRay™ system with UV technology keeps the water 99% pure for much longer, thereby restricting the use of chemical products.

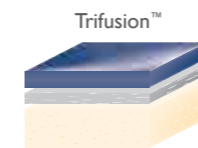

Winter Pro Kit

Our new Winter Pro kit allows you to use your hot tub during winter or in the colder weather with sensible energy savings. Based on the tests executed according to CEC standards (California Energy Commission), the energy necessary to keep water at the temperature of 39° c decreases impressively.

Perfect and constant temperature

Thanks to the electric heater, the water can be brought to the desired temperature by way of 2 programming modes that offer steady heat when required and fuel economy.

City™ Spa, the urban dimension of wellness

Inspired by the rules of space-saving, Jacuzzi® has created City™ Spa. Ideal for urban contexts, it features compact, extremely geometric aesthetic lines and its internal ergonomics are enhanced to the point of **offering two lounge seats within a space of just 2.4 m²**. In addition, thanks **to its limited floor load**, it is the first hot tub that can be installed in penthouses and on terraces. Designed to transform the home bathroom into a beauty spa, it prestigiously enhances the wellness area of even smaller gyms, hotels, gardens and shared spaces.

Flow, the most prestigious design shows off Jacuzzi® wellness

Flow is the cutting-edge hot tub that revolutionises the way of perceiving wellness. Inspired by City™ Spa and created from our collaboration with the top designer Daniel Libeskind, it is a perfect synthesis of design and functionality, elegance and technology. Its iconic, futuristic forms which open upwards like a vortex are inspired by the spas of the classical world, making it the exceptional star of prestigious urban installations, such as penthouses, terraces, patios and large bathrooms.



flow

design
Daniel Libeskind

Designed by Libeskind.
When functionality becomes art.

The pleasure of a hot tub
even on your terrace at home.

city™ spa

design
Kaluderovic & Condini







200 x 200 (Ø224) x 81H cm

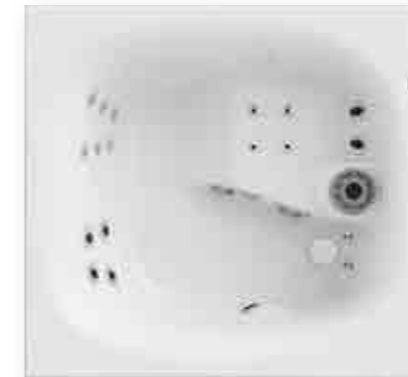

160 x 150 x 75H cm







-  x2
(2 lounge)
-  Water capacity
570 L
-  Audio System
-  ClearRay™
-  Multicolor

20 POWERPRO® JETS

-  FX
6
-  RX
2
-  NX2
8
-  BX
4

20 POWERPRO® JETS

-  FX
6
-  RX
2
-  NX2
8
-  BX
4

-  x2
(2 lounge)
-  Water capacity
570 L
-  Audio System
(optional)
-  ClearRay™
-  Multicolor



delfi delos santorini pro unique alimia

italian design



Winter Pro Kit

Our new Winter Pro kit allows you to use your hot tub during winter or in the colder weather with sensible energy savings. Based on the tests executed according to CEC standards (California Energy Commission), the energy necessary to keep water at the temperature of 39 °C decreases impressively.

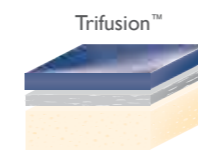

The perfect temperature

Keep your water temperature as you like it. With 2 programmable settings, you can maintain a consistent temperature or use an eco mode.

The rhythm of hydrotherapy

These hot tubs feature an MP3 player and Bluetooth facility, to enhance your moments of relaxation with your favorite music.

Keep water clear for longer

Some models feature a water skimmer that removes the larger particles from the water surface. Our ClearRay™ system with UV technology also treats 99.9% of water, so you need fewer chemicals to maintain it for longer.

The signature on hot tub design

The clean, contemporary lines of each hot tub design depict the fusion of functional hydrotherapy with European elegance.

Control at the touch of a button

The user friendly LCD or LED control panels are designed to be clear and simple. With intuitive menus, they offer immediate control to enable, disable, and adjust every aspect of the tub.

Spa-Pack Performance

Some models of the Italian Design range can be provided with the "Spa-Pack Performance" as optional. Thanks to the sand filter and to the circulation pump, the "Spa-Pack Performance" is suitable for use in semi-professional environments or for private users requiring utmost safety in hygiene for families and friends. Please refer to your local Jacuzzi® dealer for further information.



delfi

delfi, delfi pro, delfi pro sound

design
Kaluderovic & Condini

x4
(1 lounge)



Water capacity
1170 L



Spa Pack
"Performance"
(OPTIONAL)



Audio System
(PRO SOUND)



ClearRay™
(PRO SOUND)



Waterfall
(PRO,
PRO SOUND)



Multicolor
(PRO SOUND)



16 POWERPRO® JETS
10 BLOWERS (PRO SOUND)



190 x 190 x 80H cm



Exclusive design and exquisite materials for maximum capacity.

delos, delos pro, delos pro sound

design
Kaluderovic & Condini

16 POWERPRO® JETS
10 BLOWERS (PRO SOUND)

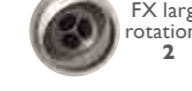

215 x 190 x 80H cm

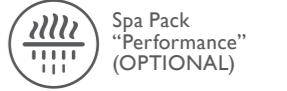
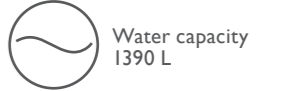

santorini pro

santorini pro, santorini pro sound

Elegant design, refined finishings and two welcoming lounge seats.

design
Kaluderovic & Condini

- x5 (2 lounge) 
- Water capacity 1800 L 
- Spa Pack "Performance" (OPTIONAL) 
- Audio System (PRO SOUND) 
- ClearRay™ 
- Waterfall 
- Multicolor 

29 POWERPRO® JETS
14 BLOWERS

- MX2 1 
- FX 11 
- RX 4 
- NX2 10 
- FX large rotational 3 



230 x 215 x 90H cm



The ideal design for any type of environment thanks to its customisable look.

unique

unique base
unique top

design
Carlo Urbinati







190 x 150 x 80H cm



14 POWERPRO® JETS
10 BLOWERS (TOP)

-  FX 4
-  RX 2
-  NX2 6
-  FX large 2

-  x3 (1 lounge)
-  Water capacity 1030 L
-  Audio System (TOP)
-  ClearRay™ (optional for BASE version)
-  Multicolor



alimia

NEW

The circular hot tub, a design icon and an oasis of wellness and happiness.

design
Jacuzzi®

Ø212 x 90H cm



x5-6



Water capacity
1650 L



ClearRay™



Multicolor



34 CLASSIC JETS





Water has no boundaries

This innovative hot tub allows you to experience the luxurious deep immersion and beauty of a commercial infinity pool in your own garden. This is the first domestic hot tub in the world that features an overflow grid and integrated compensation tank. Hidden audio system and controls contribute to the seamless surface and contemporary look.

Keep water instantly clear

The Instant Clear function allows you to boost the filtration system whenever you need it to work harder at filtering the water. This is especially useful in situations such as before or after a party with friends. Our ClearRay™ system with UV technology also treats 99.9% of water in the tub, so you need fewer chemicals to maintain it for longer.

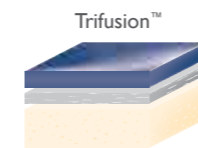

Winter Pro Kit

Our new Winter Pro kit allows you to use your hot tub during winter or in the colder weather with sensible energy savings. Based on the tests executed according to CEC standards (California Energy Commission), the energy necessary to keep water at the temperature of 39° c decreases impressively.

Lighting the way

Add to your relaxation with mood changing interior lighting. The simple LEDs offer various colours that soothe your mind as worries disappear.

The sound and smell of your hot tub

The hot tub conceals a holder for aromatherapy beads, letting you relax in the aroma of your choice. The 4 speaker audio system is also concealed with a cross-over filter and subwoofer. The system includes a radio and Bluetooth® connection with a remote control.

Stay in control

The user friendly LCD control panel is the only thing you can see. The intuitive interface lets you manage your hydromassage through the pumps, aromatherapy, lighting, and audio system.

Spa-Pack Performance

Some models of the Italian Design range can be provided with the "Spa-Pack Performance" as optional. Thanks to the sand filter and to the circulation pump, the "Spa-Pack Performance" is suitable for use in semi-professional environments or for private users requiring utmost safety in hygiene for families and friends. Please refer to your local Jacuzzi® dealer for further information.

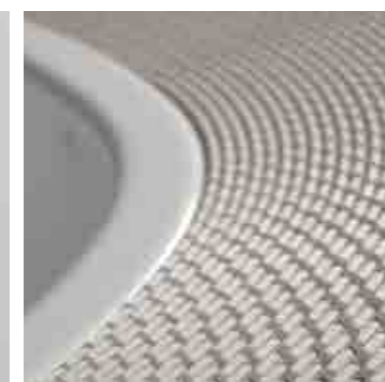

profile

design
Jacuzzi®

The experience of total immersion
at top performance.



235(239) x 211(215) x 93H cm



x5-6
(1 lounge)



Water capacity
2110 L



Spa Pack
"Performance"
(OPTIONAL)



In Sound System
(TOP)



ClearRay™



Multicolor



31 POWERPRO® JETS
14 BLOWERS

MX2
1



FX
8



RX
6



NX2
13



FX
large
3



Colours and Finishings

		Flow	City Spa	Delfi	Delfi Pro	Delfi Pro Sound	Delos	Delos Pro	Delos Pro Sound	Santorini Pro	Santorini Pro Sound	Unique	Alimia	Profile
shell colours	white	●	●	●	●	●	●	●	●	●	●	●	●	●
	cobalt			●	●	●	●	●	●	●	●		●	●
	platinum			●	●	●	●	●	●	●	●	●	●	●
customisable panels			●									●		
wood panels (colours)	sasha		●											
	teak											●		
	teak													●
	teak		●	●	●	●	●	●	●	●	●			
	veined oak				●	●		●	●	●	●			
	wenge											●		
acrylic white panels			●											
synthetic wood	sahara		●									●		
	graphite			●	●	●	●	●	●	●	●		●	●
covers	Platin (leatherette)		●											
	Ice (leatherette)		●	●	●	●	●	●	●	●	●	●	●	●
	Ice (fabric)											●		
	Ice Sunbed (fabric)											●		



🚶x6



p. 80
enjoy
seating capacity 6

🚶x7



p. 83
alimia experience
seating capacity 6-7



p. 81
virginia experience
seating capacity 6-7

🚶x8



p. 82
sienna experience
seating capacity 7-8

Beautiful and elegant, the Professional range is suitable for a wide range of commercial applications including holiday homes, wellness centres, golf clubs and small leisure clubs. Different to a domestic hot tub, installation is in-ground and involves installing a separate spa pack and compensation tank to allow water to continuously move through a quartz sand filter where it is cleaned before flowing back into the tub.

professional

professional



Professional clean water.

The quartz sand filter provides superior filtration ideal for more frequent use. Filtered water flows back into the tub through the ground drainage point. This creates an underwater fountain effect from the bottom of the hot tub, but also means that particles are collected by the jets more effectively and directed back through the overflow to the filter constantly.

Professional quiet time.

A wonderful benefit of using a Professional hot tub is that it is much quieter to run, as the working parts and the filtration processes can be positioned far from the hot tub. They can be separated to the hot tub by up to 6 meters. This allows you to enjoy your hydromassage to the fullest.

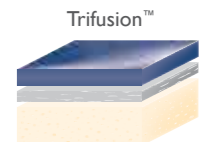

Professional recycled water.

A distinctive feature of the Professional range, is the 15° angled overflow grid around the surface of the hot tub. It 'collects' surface water, which overflows through the grid to a storage tank and filter. The cleaned water is then pumped back into the base of the hot tub and reused.

Professional colour.

There are underwater LED spotlights that illuminate the whole hot tub during your massage. Watch the colours change as your body relaxes.

Professional immersion.

Since the water level reaches the physical rim of the hot tub, you can be sure of deep immersion in your favorite Jacuzzi® hot tub massage seat. No more cold shoulders!

Professional massage.

The jets included in a Professional hot tub are strategically placed for maximum hydromassage. They are all adjustable and differ in pressure and performance. The stainless steel covers add to the character and the blowers provide a continual champagne effect.

		Enjoy	Virginia Experience	Sienna Experience	Alimia Experience
shell colours	white	●	●	●	●
	cobalt	●	●	●	●
	platinum	●	●	●	●
cover	Ice (leatherette)	●	●	●	●



Spa-Pack

The Experience hot tubs baths are also distinguished by the very low noise level of the system. The Jacuzzi® technicians have in fact designed the set of pumps, the water heating system consisting of the electric heater and of the heat-exchangers, the compressors for the blowers and an optional ionizer (indispensable to further increase water quality) in an independent technical compartment (Spa pack) that can be positioned at a distance of up to 6 metres.

Thanks to superior quality filtering, the quartz sand filter makes the Experience hot tubs ideal for professional use. The filtered water flows back to the hot tub through the ground drainage point: this method, as well as offering the visual effect of an "underwater fountain", sends the particles deposited at the bottom of the hot tub into circulation making them more likely to be captured by the jets that send the water to the filter. Although it is technically complex, the system is easy to manage even by home users by means of pneumatically controlled buttons.

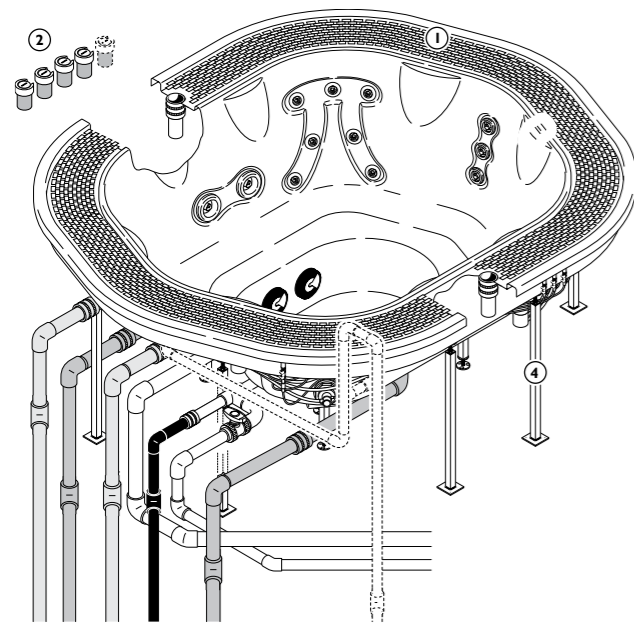

Spa and piping system

- 1 - Overflow channel with grid
- 2 - Pneumatic buttons
- 3 - Connections to plumbing
- 4 - Perimeter metal supports

Spa-PACK

- 5 - Electric wiring box
- 6 - Optional:
- 6a - Heater (12kW)
- 6b - Heat exchanger (40.000 Kcal/h)
- 7 - Hydromassage pumps (2+2 Hp)
- 8 - Filtering pump
- 9 - Quartz sand filter
- 10 - Safety switch
- 11 - Temperature sensor

Compensation tank

- 12 - Water loading/filling solenoid valve (3/4")
- 13 - Pre-filters
- 14 - Overflow
- 15 - Ground drainage points

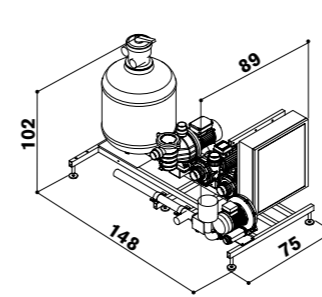
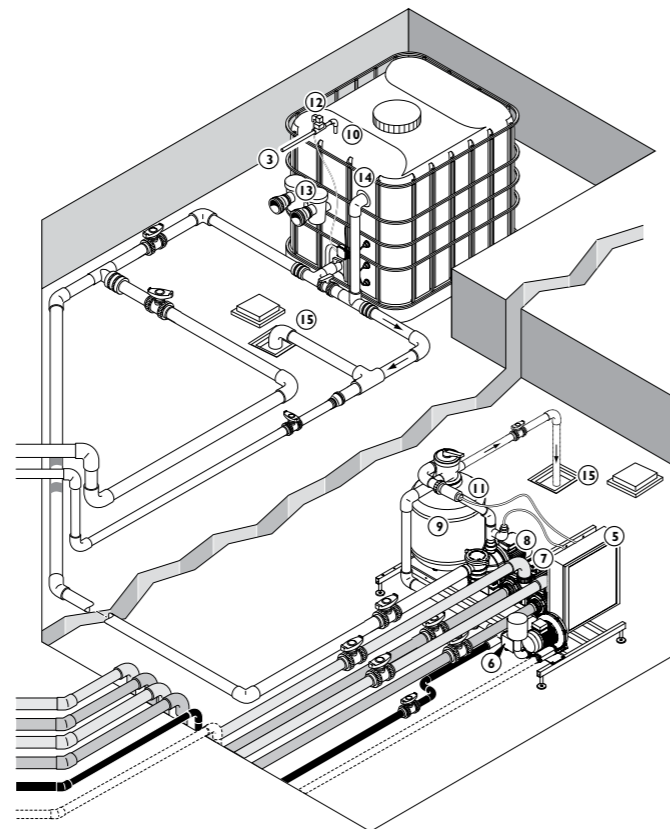

Spa-PACK

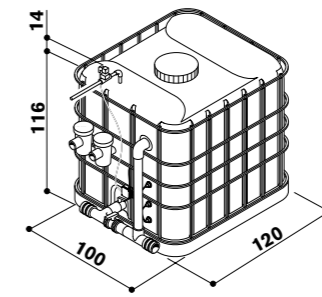

Overflow tank

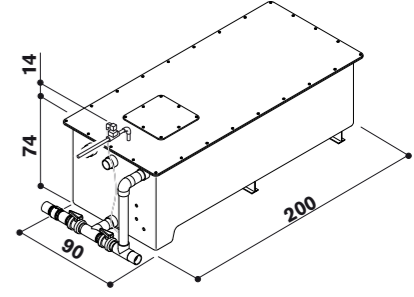

Lowered tank

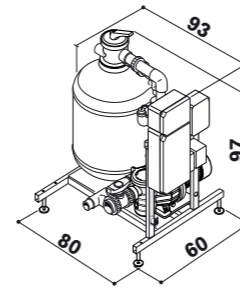

Booster Kit

Professional water analysis and control system. A completely automated system for disinfection and PH control with additional filtering section and downloadable reports.

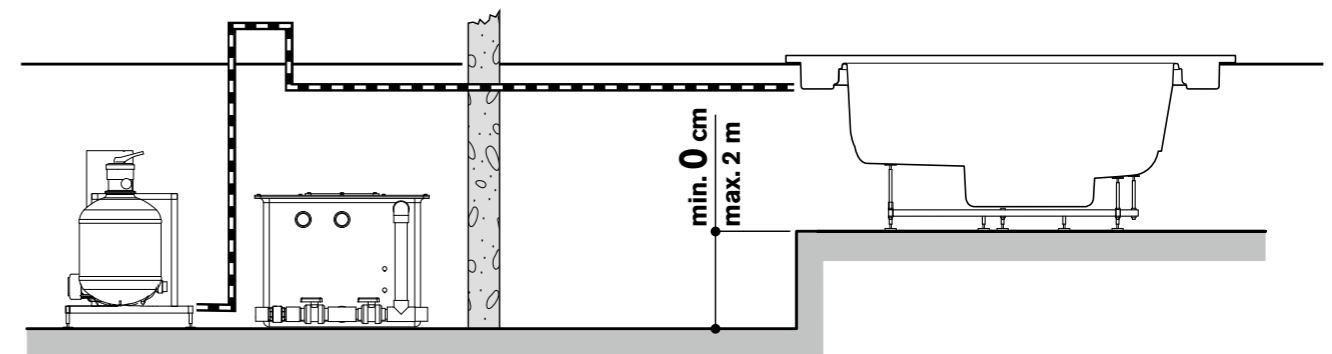
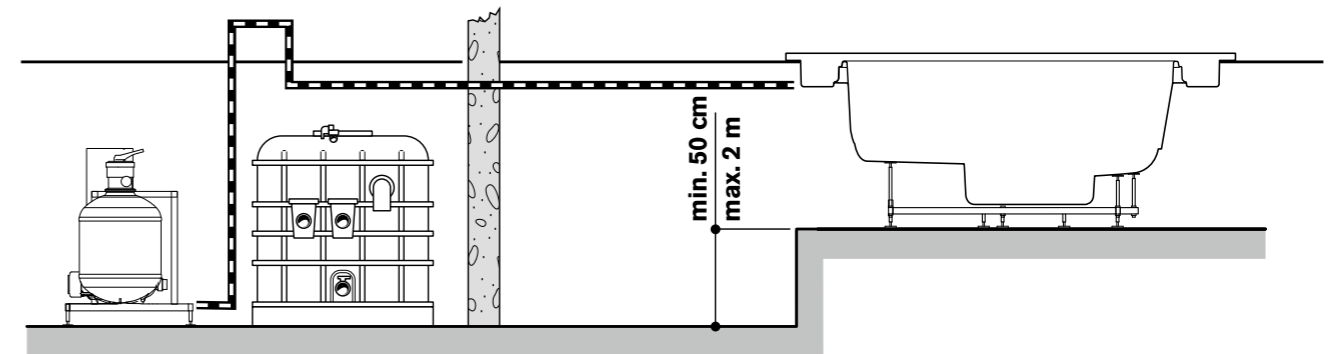

enjoy NEW

Uncompromising comfort, ergonomics and versatility for the largest professional hot tub.

design
Kaluderovic & Conдини

BASE
18 POWERPRO® JETS

FX
7



RX
2



NX2
2



FX large rotational
3



FX large
4



TOP
38 POWERPRO® JETS
15 BLOWERS

MX2
2



FX
19



RX
3



NX2
4



FX large rotational
4



FX large
6



250 x 250 x 98H cm



Versatile design and optimum capacity that seats up to 7 people.

virginia experience

design
Jacuzzi®



257 x 219 x 98H cm



34 POWERPRO® JETS
16 BLOWERS

FX
18



NX2
10



FX large
6



x6-7
(1 lounge)



Water capacity
2100 L



Spa Pack



Multicolor



x6
(1 lounge)



Water capacity
2100 L



Spa Pack



Multicolor



sienna experience

Soft lines, original shape, maximum capacity: ideal for 7/8 persons.

design
Jacuzzi®





257 x 219 x 98H cm



- x7-8 
- Water capacity 1760 L 
- Spa Pack 
- Multicolor 

30 POWERPRO® JETS
16 BLOWERS

- FX 17 
- NX2 8 
- FX large 5 

An oasis of wellness with superior technology, ideal for 7 persons.

alimia experience

design
Jacuzzi®



Ø237 x 98H cm



28 POWERPRO® JETS
16 BLOWERS

- FX 17 
- NX2 6 
- FX large 5 

- x6-7 
- Water capacity 1660 L 
- Spa Pack 
- Multicolor 



Rattan accessories

Exclusively for Italian Design series

design
Kaluderovic & Condini

delfi

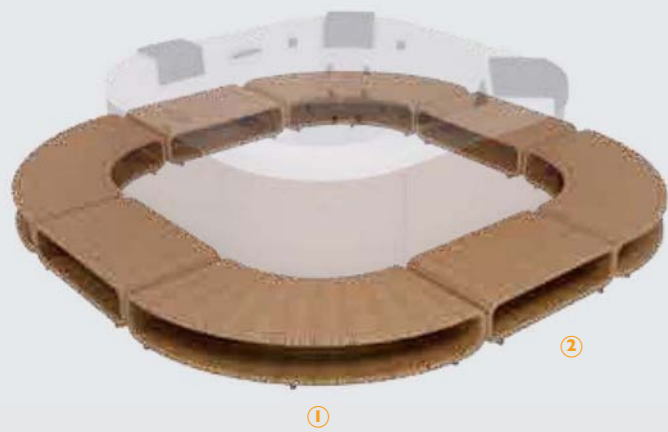

①
Corner platform
R 105 x 50 x 22.5 H cm



②
Platform
82 x 50 x 22.5 H cm

delos



③
Step
107 x 50 x 42.5 H cm

santorini pro

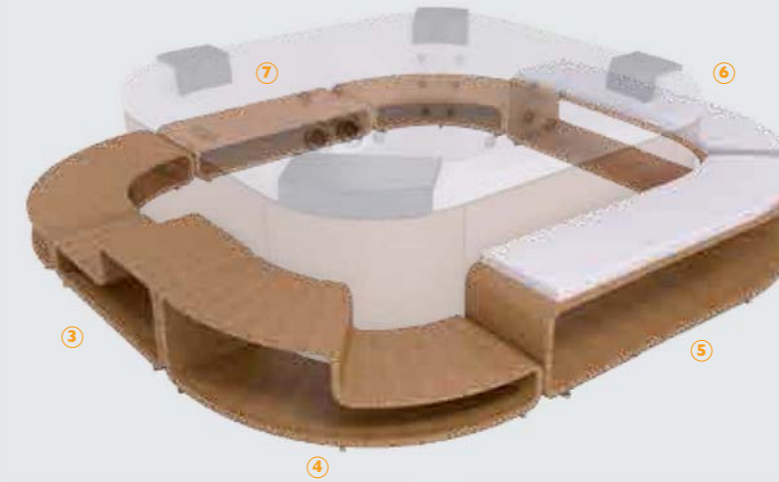

④
Corner step
R 105 x 50 x 42.5 H cm



⑤
Sofa
122 x 50 x 42.5 H Sx cm



⑦
Platform
122 x 50 x 22.5 H cm



⑥
Sofa
107 x 50 x 42.5 H Dx cm

Make a statement in your garden or conservatory with rattan style furniture that suits our Italian Design range. They look elegant and refined while offering functional style, quality and comfort. The angled pieces suit only the Santorini Pro, Delos and Delfi models. Our Rattan range is not weather resistant.

Wood accessories

Exclusively for Italian Design series

design
Kaluderovic & Condini



table

60 x 60 x 70 H cm



storage unit with lid

60 x 60 x 36 H cm



corner flower planter

58.5/58.5 x 34 x 36 H cm
R 58.5 cm

*New wood elements.



low corner step*

R 105x50x20 H cm



high/low L820 step*

82 x 50 x 40 H cm



high/low L1070 step*

107 x 50 x 40 H cm



corner platform

58.5/58.5 x 34 x 36 H cm
R 58.5 cm



tall bench

118 x 34 x 36 H cm
138 x 34 x 36 H cm
153 x 34 x 36 H cm
164 x 34 x 36 H cm
176 x 34 x 36 H cm
188 x 34 x 36 H cm



access steps

78 x 60 x 18/36 H cm
93 x 60 x 18/36 H cm
116 x 60 x 18/36 H cm
128 x 60 x 18/36 H cm

If you love real wood, then our wooden collection of garden furniture is for you. Perfect your new hot tub experience with taste and durability of the natural kind. The teak colour finish works well with our Italian Design range, whose cabinets are also a teak colour.

Synthetic wood

Exclusively for Premium series



ProEndure™ Premium steps

Your safety is our highest priority, so we always recommend accessorising your new hot tub with a set of steps. Our ProEndure™ collection of steps offers practical solutions for you to entertain and socialise around your hot tub safely. They are manufactured in synthetic materials which ensure their longevity and easy maintenance. They are also built using the same materials as the Premium hot tubs, coordinating nicely and making your garden neat and inviting.

Measures:

Step – 76 cm

Large step – 81 cm

Colours:

Brazilian Teak

Roasted Chestnut

Silver Wood

ProStep™ JLX steps

The ProStep™ complements our J-LXL hot tub perfectly. They have a lockable accessory compartment for added convenience and include a hand rail for easy entry and exit. These steps are only available in Brazilian Teak or Roasted Chestnut finish.

Covers and energy saving

These elements not only provide practical energy saving, but also protect the shell of your hot tub and maintain your required temperature of the water.

Jacuzzi® hot tub covers protect your hot tub when it's not in use and also work effectively to maintain heat. The insulation inside our covers not only ensures that your hot tub saves energy, it also helps protect the water from contamination, keeping it clean and safe. Your Jacuzzi® hot tub cover adds an extra measure of security.



Heaters

Our energy-saving heat exchangers heat your fresh hot tub water quickly, bringing it to the desired temperature more efficiently.

Insulation

The different insulation methods inside our hot tub cabinets offer the best thermal retention. From high density, water resistant panels, SmartSeal™ insulating wrap of our Premium range to our Winter Pro kit on the Italian Design range, you can be sure that your new hot tub will keep your water warm and inviting for when you need it most and also during the cold season. It'll also do it more efficiently and effectively than you expect.

Based on the CEC tests on our Winter Pro Kit, the results in terms of energy efficiency are remarkable.

Cover lifters

Exclusively for Premium series

Remove your hot tub cover with ease. The Covermate I has only one moving part and a built-in stop mechanism allowing installation to be quick and easy. It is a manual lift, which is ideal for hot tubs in gazebos or where space is limited. The Covermate III combines gas shock mechanisms which make opening covers effortless. The large aluminium mounting brackets, tubing and full bar construction provide superior strength. Ask which cover lifter will suit your Jacuzzi® hot tub.

Cleaning and Maintenance

All the products you need to keep your hot tub water pristine clean

It is really important for your hot tub water to be always clean and clear without substances and/or micro-organisms that may make it unsuitable for bathing.



For crystal-clear, pure water it is important to:

- **filter it** (this is carried out by the combined action of the pump and filter) to eliminate macroscopic particles that enter the hot tub from the surrounding environment and/or from the users. Some models are provided with paper cartridge filters while in others the filter is in quartz sand;
- **disinfect it** using specific disinfectants that prevent the proliferation of algae and/or bacteria.

Jacuzzi® has created a complete range of water treatment and hot tub cleaning products.



Jacuzzi® Oxygen Starter Kit



To maintain and treat the wooden parts of our Italian Design range, you should use ActionWood, our water resistant wood treatment.

After sales service



We are proud to work with so many Jacuzzi® authorised retailers worldwide and it is great that the number of Jacuzzi® retailers continues to grow. Your local Jacuzzi® authorised retailer will be able to help you with all your questions and enquiries regarding installation, delivery, water maintenance and any technical information you require. They may also offer credit services to help you pay for your new investment. We are available, with our retailers to help you with any questions or issues you may have. Our team of qualified engineers will visit your hot tub to repair it or service it as you require, just contact your retailer for more information. You can relax, you've got a Jacuzzi® hot tub and that means you're in safe hands.

premium



Features/Technical Data

			J495	J480
Dimensions	Length	cm	229	239
	Width	cm	279	239
	Height	cm	104/115	99/112
Weights and capacity	Average fill	l	2120	1817
	Water capacity (total volume)	l	2574	2271
	Net weight	kg	517	454
	Total max weight	Kg	3089	2724
	max floor load	Kg/m ²	498	504
Electrical requirements	Power supply		220-240V - 50Hz	220-240V - 50Hz
	Max. absorption with electric heater		8.7kW- 38A	6.5kW - 28A
	Electric heater	kW	2.7	2.7
Pumps	Pump 1		2HP/1.5kW - 1 speed	2HP/1.5kW - 1 speed
	Pump 2		2HP/1.5kW - 1 speed	2HP/1.5kW - 1 speed
	Pump 3		2HP/1.5kW - 1 speed	--
	Circulation Pump		●	●
Water Management System	Filter		ProClarity 40 sq ft filter cartridge and ProClarity load filter; ProCatch bag with ProClear 75 sq ft Filter; Floating Weir	ProClarity 40 sq ft filter cartridge and ProClarity load filter; ProCatch bag with ProClear 75 sq ft Filter; Floating Weir
	Clear Ray		●	●
Installation	Freestanding		●	●
	Built-in		--	--
Features	Seats		8/9	6
	Lounge		--	1
	Jets		62	52
	Blowers		--	--
	Lighting		Multicolor	Multicolor
	Waterfall		2 w/lights	2 w/lights
	LED Control Panel		--	--
	LCD Control Panel		●	●
	Stereo System		○	○
			Blue Wave Stereo System with docking station, aux, usb port, bluetooth, FM radio and 8 speakers	Blue Wave Stereo System with docking station, aux, usb port, bluetooth, FM radio and 8 speakers
	Remote Control (for versions w/stereo)		○	○
	Heater		●	●
	Headrests		4 lighted	4 lighted
	Smart Seal		○	○
Colours (shell)	Platinum		●	●
	Desert Sand		●	●
	Silver Pearl		●	●
	Opal		--	●
	Midnight		--	●
	Caribbean Surf		--	●
	Slate Green		--	●
Skirting	Synthetic Wood	Brazilian Teak	●	●
		Silver Wood	●	●
		Roasted Chestnut	--	●
Covers		Ice Sunbed (Fabric)	--	●
		Bordeaux (leatherette)	●	●
		Silver Wood (leatherette)	●	●

Jets ● Included ○ Please contact your local retailer for specifications

Features/Technical Data

			J470
Dimensions	Length	cm	231
	Width	cm	231
	Height	cm	99/112
Weights and capacity	Average fill	l	1703
	Water capacity (total volume)	l	2120
	Net weight	kg	431
	Total max weight	Kg	2549
	max floor load	Kg/m ²	480
Electrical requirements	Power supply		220-240V - 50 hz
	Max. absorption with electric heater		6.5kW - 28A
	Electric heater	kW	2.7
Pumps	Pump 1		2HP/1.5kW - 1 speed
	Pump 2		2HP/1.5kW - 1 speed
	Pump 3		--
	Circulation Pump		●
Water Management System	Filter		ProClarity 40 sq ft filter cartridge and ProClarity load filter; ProCatch bag with ProClear 75 sq ft Filter; Floating Weir
	Clear Ray		●
Installation	Freestanding		●
	Built-in		--
Features	Seats		6/7
	Lounge		--
	Jets		43
	Blowers		--
	Lighting		Multicolor
	Waterfall		2 w/lights
	LED Control Panel		--
	LCD Control Panel		●
	Stereo System		○
			Blue Wave Stereo System with docking station, aux, usb port, bluetooth, FM radio and 8 speakers
	Remote Control (for versions w/stereo)		○
	Heater		●
	Headrests		4 lighted
	Smart Seal		○
Colours (shell)	Platinum		●
	Desert Sand		●
	Silver Pearl		●
	Opal		●
	Midnight		●
	Caribbean Surf		●
	Slate Green		●
Skirting	Synthetic Wood	Brazilian Teak	●
		Silver Wood	●
		Roasted Chestnut	●
Covers		Ice Sunbed (Fabric)	--
		Bordeaux (leatherette)	●
		Silver Wood (leatherette)	●

Jets ● Included ○ Please contact your local retailer for specifications

premium



Features/Technical Data

			J465	J415
Dimensions	Length	cm	224	193
	Width	cm	224	168
	Height	cm	99/112	81
Weights and capacity	Average fill	l	1552	871
	Water capacity (total volume)	l	1931	1098
	Net weight	kg	411	265
	Total max weight	Kg	2340	1362
	max floor load	Kg/m ²	532	439
Electrical requirements	Power supply		220-240V - 50Hz	220-240V - 50Hz
	Max. absorption with electric heater		6.5kW - 28A	6.5kW - 28A
	Electric heater	kW	2.7	2.7
Pumps	Pump 1		2HP/1.5kW - 1 speed	2HP/1.5kW - 1 speed
	Pump 2		2HP/1.5kW - 1 speed	--
	Pump 3		--	--
	Circulation Pump		●	●
Water Management System	Filter		ProClarity 40 sq ft filter cartridge and ProClarity load filter. ProCatch bag with ProClear 75 sq ft Filter, Floating Weir	ProClarity 40 sq ft filter cartridge and ProClarity load filter. ProCatch bag with ProClear 75 sq ft Filter, Floating Weir
	Clear Ray		●	●
Installation	Freestanding		●	●
	Built-in		--	--
Features	Seats		6	3
	Lounge		1	1
	Jets		39	21
	Blowers		--	--
	Lighting		Multicolor	Multicolor
	Waterfall		1 w/lights	1 w/lights
	LED Control Panel		--	--
	LCD Control Panel		●	●
	Stereo System		○	○
			Blue Wave Stereo System with docking station, aux, usb port, bluetooth, FM radio and 8 speakers	Blue Wave Stereo System with docking station, aux, usb port, bluetooth, FM radio and 8 speakers
	Remote Control (for versions w/stereo)		○	○
	Heater		●	●
	Headrests		4 lighted	1 lighted
	Smart Seal		○	○
	Colours (shell)	Platinum		●
Desert Sand			●	●
Silver Pearl			●	●
Opal			●	●
Midnight			●	--
Caribbean Surf			●	--
Slate Green			●	●
			●	●
Skirting	Synthetic Wood	Brazilian Teak	●	●
		Silver Wood	●	●
		Roasted Chestnut	●	●
Covers		Ice Sunbed (Fabric)	●	●
		Bordeaux (leatherette)	●	●
		Silver Wood (leatherette)	●	●

Jets ● Included ○ Please contact your local retailer for specifications

Features/Technical Data

			JLXL
Dimensions	Length	cm	213
	Width	cm	213
	Height	cm	91
Weights and capacity	Average fill	l	1476
	Water capacity (total volume)	l	1893
	Net weight	kg	406
	Total max weight	kg	2298
	max floor load	kg/m ²	543
Electrical requirements	Power supply		220-240V - 50Hz
	Max. absorption with electric heater		6.5kW - 28A
	Electric heater	kW	2.7
Pumps	Pump 1		2HP/1.5kW - 2 speed
	Pump 2		2HP/1.5kW - 1 speed
	Pump 3		--
	Circulation Pump		●
Water Management System	Filter		Two 75 sq ft filter cartridges
	Clear Ray		●
Installation	Freestanding		●
	Built-in		--
Features	Seats		5
	Lounge		1
	Jets		38
	Blowers		--
	Lighting		Multicolor
	Cascade		1
	LED Control Panel		●
	LCD Control Panel		--
	Stereo System		○
			Blue Wave Stereo System with docking station, aux, usb port
	Remote Control (for versions w/stereo)		○
	Heater		●
	Headrests		3
	Smart Seal		●
	Colours (shell)	Platinum	
Silver Pearl			●
Opal			●
Slate Green			●
Skirting	Synthetic Wood	Brazilian Teak	●
		Roasted Chestnut	●
Cover		Bordeaux (leatherette)	●

Jets ● Included ○ Please contact your local retailer for specifications

premium



Features/Technical Data			J385	J375
Dimensions	Length	cm	231	231
	Width	cm	231	231
	Height	cm	96	96
Weights and capacity	Average fill	l	1893	1779
	Water capacity (total volume)	l	2196	2196
	Net weight	kg	415	407
	Total max weight	kg	2610	2601
	max floor load	kg/m ²	587	584
Electrical requirements	Power supply		220-240V - 50Hz	220-240V - 50Hz
	Max. absorption with electric heater		6.5kW - 28A	6.5kW - 28A
	Electric heater	kW	2.7	2.7
Pumps	Pump 1		2HP/1.5kW - 1 speed	2HP/1.5kW - 1 speed
	Pump 2		2HP/1.5kW - 1 speed	2HP/1.5kW - 1 speed
	Pump 3		--	--
	Circulation Pump		●	●
Water Management System	Filter		Two 60 sq ft filter cartridges	Two 60 sq ft filter cartridges
	Clear Ray		●	●
Installation	Freestanding		●	●
	Built-in		--	--
Features	Seats		6-7	6
	Lounge		--	1
	Jets		49	50
	Blowers		--	--
	Lighting		Prolites system	Prolites system
	Cascade		1 w/lights	1 w/lights
	LED Control Panel		●	●
	LCD Control Panel		--	--
	Stereo System		○	○
			Blue Wave Stereo System with docking station, aux, usb port	Blue Wave Stereo System with docking station, aux, usb port
	Remote Control (for versions w/stereo)		○	○
	Heater		●	●
	Headrests		4 lighted	4 lighted
	Smart Seal		○	○
Colours (shell)	Platinum		●	●
	Silver Pearl		●	●
	Opal		●	●
	Midnight		●	●
	Caribbean surf		●	●
	Slate Green		●	●
Skirting Synthetic Wood	Brazilian Teak		●	●
	Silver Wood		●	●
	Roasted Chestnut		●	●
Covers	Bordeaux (leatherette)		●	●
	Silver Wood (leatherette)		●	●

Jets ● Included ○ Please contact your local retailer for specifications



Features/Technical Data			J365	J355
Dimensions	Length	cm	231	231
	Width	cm	213	213
	Height	cm	97	97
Weights and capacity	Average fill	l	1666	1514
	Water capacity (total volume)	l	1893	1855
	Net weight	kg	394	379
	Total max weight	kg	2285	2233
	max floor load	kg/m ²	555	549
Electrical requirements	Power supply		220-240V - 50Hz	220-240V - 50 Hz
	Max. absorption with electric heater		6.5kW - 28A	6.5kW - 28A
	Electric heater	kW	2.7	2.7
Pumps	Pump 1		2HP/1.5kW - 1 speed	2HP/1.5kW - 1 speed
	Pump 2		2HP/1.5kW - 1 speed	2HP/1.5kW - 1 speed
	Pump 3		--	--
	Circulation Pump		●	●
Water Management System	Filter		Two 60 sq ft filter cartridges	Two 60 sq ft filter cartridges
	Clear Ray		●	●
Installation	Freestanding		●	●
	Built-in		--	--
Features	Seats		6	5-6
	Lounge		--	1
	Jets		44	42
	Blowers		--	--
	Lighting		Prolites system	Prolites system
	Cascade		1 w/lights	1 w/lights
	LED Control Panel		●	●
	LCD Control Panel		--	--
	Stereo System		○	○
			Blue Wave Stereo System with docking station, aux, usb port	Blue Wave Stereo System with remote control, docking station, aux, usb port, Bluetooth™, FM radio and 4 speakers
	Remote Control (for versions w/stereo)		○	○
	Heater		●	●
	Headrests		4 lighted	3 lighted
	Smart Seal		○	○
Colours (shell)	Platinum		●	●
	Silver Pearl		●	●
	Opal		●	●
	Midnight		●	●
	Caribbean surf		●	●
	Slate Green		●	●
Skirting Synthetic Wood	Brazilian Teak		●	●
	Silver Wood		●	●
	Roasted Chestnut		●	●
Covers	Bordeaux (leatherette)		●	●
	Silver Wood (leatherette)		●	●

Jets ● Included ○ Please contact your local retailer for specifications

premium



Features/Technical Data

			J345	J335	J315	
Dimensions	Length	cm	213	213	193	
	Width	cm	213	213	168	
	Height	cm	91	91	81	
Weights and capacity	Average fill	l	1401	1363	814	
	Water capacity (total volume)	l	1741	1704	814	
	Net weight	kg	347	342	259	
	Total max weight	kg	2087	2044	1043	
	max floor load	kg/m ²	555	549	407	
Electrical requirements	Power supply		220-240V - 50 hz	220-240V - 50 hz	220-240V - 50Hz	
	Max. absorption with electric heater		6.5kW - 28A	6.5kW - 28A	4.8kW - 21A	
	Electric heater	kW	2.7	2.7	2.7	
Pumps	Pump 1		2HP/1.5kW - 1 speed	2HP/1.5kW - 1 speed	2HP/1.5kW - 1 speed	
	Pump 2		2HP/1.5kW - 1 speed	2HP/1.5kW - 1 speed	--	
	Pump 3		--	--	--	
	Circulation Pump		●	●	●	
Water Management System	Filter		Two 60 sq ft filter cartridges	Two 60 sq ft filter cartridges	Two 60 sq ft filter cartridges	
	Clear Ray		●	●	●	
Installation	Freestanding		●	●	●	
	Built-in		--	--	--	
Features	Seats		5-6	4-5	3	
	Lounge		1	1	1	
	Jets		40	40	21	
	Blowers		--	--	--	
	Lighting		Prolites system	Prolites system	Prolites system	
	Cascade		1 w/lights	1 w/lights	1 w/lights	
	LED Control Panel		●	●	●	
	LCD Control Panel		--	--	--	
	Stereo System		○ Blue Wave Stereo System with remote control, docking station, aux, usb port, Bluetooth™, FM radio and 4 speakers	○ Blue Wave Stereo System with remote control, docking station, aux, usb port, Bluetooth™, FM radio and 4 speakers	○ Blue Wave Stereo System with remote control, docking station, aux, usb port, Bluetooth™, FM radio and 4 speakers	
	Remote Control (for versions w/stereo)		○	○	○	
	Heater		●	●	●	
	Headrests		4 lighted	4 lighted	3 lighted	
	Smart Seal		○	○	○	
	Colours (shell)	Platinum		●	●	●
		Silver Pearl		●	●	●
Opal			●	●	●	
Midnight			●	●	--	
Caribbean surf			●	●	--	
Slate Green			●	●	●	
Skirting	Synthetic Wood	Brazilian Teak	●	●	●	
		Silver Wood	●	●	●	
		Roasted Chestnut	●	●	●	
Covers	Bordeaux (leatherette)	●	●	●		
	Silver Wood (leatherette)	●	●	●		

Jets ● Included ○ Please contact your local retailer for specifications



Features/Technical Data

			J275	J245	J235	J210	
Dimensions	Length	cm	228	213	213	∅ 198	
	Width	cm	228	213	213	--	
	Height	cm	91	91	91	91	
Weights and capacity	Average fill	l	1590	1363	1363	908	
	Water capacity (total volume)	l	2006	1779	1741	1173	
	Net weight	kg	366	375	326	239	
	total max weight	kg	2371	2153	2066	1412	
	max floor load	kg/m ²	495	555	532	569	
Electrical requirements	Power supply		220-240V - 50 hz	220-240V - 50 hz	220-240V - 50 hz	220-240V - 50 hz	
	Max. absorption with electric heater		6.7 Kw - 29A	6.7 Kw - 29A	6.7 Kw - 29A	4.8Kw - 21A	
	Electric heater	kW	2.7	2.7	2.7	2.7	
Pumps	Pump 1		2 HP/1.5kW 2 speed	2 HP/1.5kW 2 speed	2 HP/1.5kW 2 speed	2 HP/1.5kW 2 speed	
	Pump 2		2 HP/1.8kW 1 speed	2 HP/1.8kW 1 speed	2 HP/1.8kW 1 speed	--	
	Pump 3		--	--	--	--	
	Circulation Pump		--	--	--	--	
Water Management System	Filter		Cartridge 1 x 50 sq ft	Cartridge 1 x 50 sq ft	Cartridge 1 x 50 sq ft	Cartridge 1 x 50 sq ft	
	Clear Ray		●	●	●	●	
Installation	Freestanding		●	●	●	●	
	Built-in		--	--	--	--	
Features	Seats		6	6-7	6	4	
	Lounge		1	--	1	--	
	Jets		45	35	35	19	
	Blowers		--	--	--	--	
	Lighting		Classic 10 leds	Classic 10 leds	Classic 10 leds	Multicolor	
	Cascade		1	1	1	1	
	LED Control Panel		●	●	●	●	
	LCD Control Panel		--	--	--	--	
	Stereo System		○ Blue Wave Stereo System with remote control, docking station, aux, usb port, Bluetooth™, FM radio and 4 speakers	○ Blue Wave Stereo System with remote control, docking station, aux, usb port, Bluetooth™, FM radio and 4 speakers	○ Blue Wave Stereo System with remote control, docking station, aux, usb port, Bluetooth™, FM radio and 4 speakers	--	
	Remote Control (for versions w/stereo)		○	○	○	--	
	Heater		●	●	●	●	
	Headrests		3	4	3	--	
	Smart Seal		--	--	--	--	
	Colours (shell)	Platinum (65)		●	●	●	●
		Silver Wood		●	●	●	●
Skirting	Synthetic Wood	Roasted Chestnut	●	●	●	●	
		Bordeaux (leatherette)	●	●	●	●	
Covers	Silver Wood (leatherette)	●	●	●	●		

Jets ● Included ○ Please contact your local retailer for specifications

italian design



Features/Technical Data

			Flow	City Spa
Dimensions	Length	cm	200	160
	Width	cm	200 (Ø 224)	150
	Height	cm	81	75
Weights and capacity	Average fill	l	470	470
	Water capacity (total volume)	l	570	570
	Net weight	kg	300	220
	Total max weight	Kg	870	790
	Spa floor load	Kg/m ²	360/385	330/350
Electrical requirements	Power supply		220-240V - 50Hz	220-240V - 50Hz
	Electric heater	kW	1.5 or 2.0	1.5 or 2.0
	Max. absorption with electric heater		4.25 Kw - 17.5 A (2kW heater)	4.25 Kw - 17.5 A (2kW heater)
			1.8kW - 8 A (1.5kW heater)	1.8kW - 8 A (1.5kW heater)
	Max. absorption without electric heater	kW	--	--
Heater exchanger	kcal/l	--	--	
Pumps	Pump 1		2.5HP/1.8kW 1 speed	2.5HP/1.8kW 1 speed
	Pump 2		--	--
	Circulation Pump		●	●
Water Management System	Skimmer tipology		Floating	Floating
	Cartridge for filter	Sq.Ft.	1 x 50	1 x 50
	Clear Ray		●	●
Installation	Freestanding		●	●
	Built-in		--	●
Features	Seats		2	2
	Lounge		2	2
	Jets		20	20
	Blowers		--	--
	Lighting		Multicolor	Multicolor
	Waterfall		--	--
	LED Control Panel		●	●
	LCD Control Panel		--	--
	Audio System with Blue Tooth		●	○
	Remote Control		--	--
	Electric heater		●	●
	Heat Exchanger		--	--
	Automatic Water fill-up		--	--
	Aromatherapy		--	--
	Headrests		--	--
Features - optional only	Winter Pro Kit		optional	optional
Colours (shell)	White		●	●
	Customisable panels		--	●
Skirting	Wood	Sasha	--	●
		Teak	--	●
	Acrylic	White	●	--
	Synthetic Wood	Sahara	--	●
Covers	Platin (leatherette)		●	--
	Ice (leatherette)		--	●

Jets

● Included

○ Please contact your local retailer for specifications

Features/Technical Data

			Delfi	Delfi Pro	Delfi Pro Sound
Dimensions	Length	cm	190	190	190
	Width	cm	190	190	190
	Height	cm	80	80	80
Weights and capacity	Average fill	l	700	700	700
	Water capacity (total volume)	l	1170	1170	1170
	Net weight	kg	270	270	270
	Total max weight	Kg	1440	1440	1440
	Spa floor load	Kg/m ²	450/460	450/460	450/460
Electrical requirements	Power supply		220-240V - 50Hz	220-240V - 50Hz	220-240V - 50Hz
	Electric heater	kW	2	3	3
	Max. absorption with electric heater		3.5kW - 16A	5.15kW - 23A	6kW - 28A
	Max. absorption without electric heater	kW	--	1.95	2.8
Pumps	Heater exchanger	kcal/l	--	26000	26000
	Pump 1		2.5HP/1.8kW 2 speed	2.5HP/1.8kW 1 speed	2.5HP/1.8kW 1 speed
Water Management System	Pump 2		--	--	--
	Circulation Pump		--	●	●
	Skimmer tipology		Rectangular cassette	Rectangular cassette	Rectangular cassette
Installation	Cartridge for filter	Sq.Ft.	2 x 50	2 x 50	2 x 50
	Clear Ray		optional	optional	●
Features	Freestanding		●	●	●
	Built-in		●	●	●
	Seats		4	4	4
	Lounge		1	1	1
	Jets		16	16	16
	Blowers		--	--	10
	Lighting		white	white	Multicolor
	Waterfall		--	●	●
	LED Control Panel		●	--	--
	LCD Control Panel		--	●	●
	Audio System with Blue Tooth		--	--	●
	Remote Control		--	--	--
	Electric heater		●	○	○
	Heat Exchanger		--	○	○
	Automatic Water fill-up		--	--	--
Aromatherapy		--	--	●	
Headrests		optional	2	2	
Features - optional only	Winter Pro Kit		optional	optional	optional
	Spa Pack performance		optional	optional	optional
Colours (shell)	Cushion		optional	optional	optional
	White		●	●	●
	Cobalt		●	●	●
	Platinum		●	●	●
Skirting	Wood	Teak	●	●	●
		Veined Oak	--	●	●
Covers	Synthetic wood	Graphite	●	●	●
	Ice (leatherette)		●	●	●

Jets

● Included

○ Please contact your local retailer for specifications

italian design



Features/Technical Data			Delos	Delos Pro	Delos Pro Sound
Dimensions	Length	cm	215	215	215
	Width	cm	190	190	190
	Height	cm	80	80	80
Weights and capacity	Average fill	l	860	860	860
	Water capacity (total volume)	l	1390	1390	1390
	Net weight	kg	250	250	250
	Total max weight	Kg	1640	1640	1640
	Spa floor load	Kg/m ²	449/459	449/459	449/459
Electrical requirements	Power supply		220-240V - 50Hz	220-240V - 50Hz	220-240V - 50Hz
	Electric heater	kW	2	3	3
	Max. absorption with electric heater		3.5kW - 16A	5.15kW - 23A	6kW - 28A
	Max. absorption without electric heater	kW	--	1.95	2.8
	Heater exchanger	kcal/l	--	26000	26000
Pumps	Pump 1		2.5HP/1.8kW 2 speed	2.5HP/1.8kW 1 speed	2.5HP/1.8kW 1 speed
	Pump 2		--	--	--
	Circulation Pump		--	●	●
Water Management System	Skimmer tipology		Rectangular cassette	Rectangular cassette	Rectangular cassette
	Cartridge for filter	Sq.Ft.	2 x 50	2 x 50	2 x 50
	Clear Ray		optional	optional	●
Installation	Freestanding		●	●	●
	Built-in		●	●	●
Features	Seats		4	4	4
	Lounge		1	1	1
	Jets		16	16	16
	Blowers		--	--	10
	Lighting		white	white	Multicolor
	Waterfall		--	●	●
	LED Control Panel		●	--	--
	LCD Control Panel		--	●	●
	Audio System with Bluetooth		--	--	●
	Remote Control		--	--	--
	Electric heater		●	○	○
	Heat Exchanger		--	○	○
	Automatic Water fill-up		--	--	--
	Aromatherapy		--	--	●
Headrests		optional	3	3	
Features - optional only	Winter Pro Kit		optional	optional	optional
	Spa Pack performance		optional	optional	optional
	Cushion		optional	optional	optional
Colours (shell)	White		●	●	●
	Cobalt		●	●	●
	Platinum		●	●	●
Skirting	Wood	Teak	●	●	●
		Veined Oak	●	●	●
	Synthetic Wood	Graphite	●	●	●
Covers		Platin (leatherette)	--	--	--
		Ice (leatherette)	●	●	●

Jets ● Included ○ Please contact your local retailer for specifications

Features/Technical Data			Santorini Pro	Santorini Pro Sound
Dimensions	Length	cm	230	230
	Width	cm	215	215
	Height	cm	90	90
Weights and capacity	Average fill	l	1250	1250
	Water capacity (total volume)	l	1800	1800
	Net weight	kg	300	300
	Total max weight	Kg	2100	2100
	Spa floor load	Kg/m ²	470/479	470/479
Electrical requirements	Power supply		220-240V - 50Hz	220-240V - 50Hz
	Electric heater	kW	3	3
	Max. absorption with electric heater		5.15kW - 23A	6kW - 28A
	Max. absorption without electric heater	kW	1.95	2.8
	Heater exchanger	kcal/l	26000	26000
Pumps	Pump 1		2.5HP/1.8kW 1 speed	2.5HP/1.8kW 1 speed
	Pump 2		2.5HP/1.8kW 1 speed	2.5HP/1.8kW 1 speed
	Circulation Pump		●	●
Water Management System	Skimmer tipology		Rectangular cassette	Rectangular cassette
	Cartridge for filter	Sq.Ft.	2 x 50	2 x 50
	Clear Ray		●	●
Installation	Freestanding		●	●
	Built-in		●	●
Features	Seats		5	5
	Lounge		2	2
	Jets		29	29
	Blowers		14	14
	Lighting		Multicolor	Multicolor
	Waterfall		●	●
	LED Control Panel		--	--
	LCD Control Panel		●	●
	Audio System with Blue Tooth		--	●
	Remote Control		--	--
	Electric heater		○	○
	Heat Exchanger		○	○
	Automatic Water fill-up		--	--
	Aromatherapy		--	●
Headrests		3	3	
Features - optional only	Winter Pro Kit		optional	optional
	Spa Pack performance		optional	optional
	Cushion		optional	optional
Colours (shell)	White		●	●
	Cobalt		●	●
	Platinum		●	●
Skirting	Wood	Teak	●	●
		Veined Oak	●	●
	Synthetic Wood	Graphite	●	●
Covers		Ice (leatherette)	●	●

Jets ● Included ○ Please contact your local retailer for specifications

italian design



Features/Technical Data		Unique		Alimia	
		Base	Top		
Dimensions	Length	cm	190	190	Ø 212
	Width	cm	150	150	
	Height	cm	80	80	90
Weights and capacity	Average fill	l	630	630	1370
	Water capacity (total volume)	l	1030	1030	1650
	Net weight	kg	240	240	290
	Total max weight	Kg	1270	1270	1940
	Spa floor load	Kg/m ²	446/552	446/552	550/626
Electrical requirements	Power supply		220-240V - 50Hz	220-240V - 50Hz	220-240V - 50Hz
	Electric heater	kW	2	2	3
	Max. absorption with electric heater		3.7kW - 16A	4.4kW - 17A	5.75kW - 26A
	Max. absorption without electric heater	kW	--	--	--
Pumps	Heater exchanger	kcal/l	--	--	--
	Pump 1		2.5HP/1.8kW 2 speed	2.5HP/1.8kW 2 speed	2.5HP/1.8kW 1 speed
	Pump 2		--	--	2.5HP/1.8kW 1 speed
Water Management System	Circulation Pump		--	--	●
	Skimmer tipology		Floating	Floating	Rectangular cassette
	Cartridge for filter	Sq.Ft.	1 x 50	1 x 50	2 x 50
Installation	Clear Ray		optional	●	●
	Freestanding		●	●	●
Features	Built-in		●	●	●
	Seats		3	3	5-6
	Lounge		1	1	--
	Jets		14	14	34
	Blowers		--	10	12
	Lighting		Multicolor	Multicolor	Multicolor
	Waterfall		--	--	--
	LED Control Panel		●	●	--
	LCD Control Panel		--	--	●
	Audio System with Blue Tooth		--	●	--
	Remote Control		--	--	--
	Electric heater		●	●	●
	Heat Exchanger		--	--	--
	Automatic Water fill-up		--	--	--
	Aromatherapy		●	●	--
Headrests		3	3	--	
Features - optional only	Winter Pro Kit		optional	optional	--
	Spa Pack performance		optional	optional	--
	Cushion		--	--	--
Colours (shell)	White		●	●	●
	Cobalt		●	●	●
	Platinum		●	●	●
Skirting	Misc.	Customisable panels	●	●	--
	Wood	Teak	●	●	--
		Wengè	●	●	--
	Synthetic Wood	Sahara	●	●	--
		Graphite	--	--	●
Covers	Ice (leatherette)		●	●	●
	Ice (Fabric)		●	●	--
	Ice Sunbed (Fabric)		●	●	--

Jets ● Included ○ Please contact your local retailer for specifications

Features/Technical Data		Profile		
		Base	Top	
Dimensions	Length	cm	235/239	235/239
	Width	cm	211/215	211/215
	Height	cm	93	93
Weights and capacity	Average fill	l	1600	1600
	Water capacity (total volume)	l	2110	2110
	Net weight	kg	400	400
	Total max weight	Kg	2510	2510
	Spa floor load	Kg/m ²	506/558	506/558
Electrical requirements	Power supply		220-240V - 50Hz	220-240V - 50Hz
	Electric heater	kW	3	3
	Max. absorption with electric heater		5.75kW - 26A	5.75kW - 26A
	Max. absorption without electric heater	kW	--	--
Pumps	Heater exchanger	kcal/l	--	--
	Pump 1		2.5HP/1.8kW 1 speed	2.5HP/1.8kW 1 speed
	Pump 2		2.5HP/1.8kW 1 speed	2.5HP/1.8kW 1 speed
Water Management System	Circulation Pump		●	●
	Skimmer tipology		External grid	External grid
	Cartridge for filter	Sq.Ft.	1 x 100	1 x 100
Installation	Clear Ray		●	●
	Freestanding		●	●
Features	Built-in		●	●
	Seats		5-6	5-6
	Lounge		1	1
	Jets		31	31
	Blowers		14	14
	Lighting		Multicolor	Multicolor
	Waterfall		--	--
	LED Control Panel		--	--
	LCD Control Panel		●	●
	Audio System with Blue Tooth		--	●
	Remote Control		--	●
	Electric heater		●	●
	Heat Exchanger		--	--
	Automatic Water fill-up		●	●
	Aromatherapy		●	●
Headrests		--	--	
Features - optional only	Winter Pro Kit		optional	optional
	Spa Pack performance		optional	optional
	Cushion		--	--
Colours (shell)	White		●	●
	Cobalt		●	●
	Platinum		●	●
Skirting	Wood	Teak	●	●
	Synthetic Wood	Graphite	●	●
Cover	Ice (leatherette)		●	●

Jets ● Included ○ Please contact your local retailer for specifications

professional



Enjoy

Features/Technical Data

			Base	Top		
Dimensions	Length	cm	250	250		
	Width	cm	250	250		
	Height	cm	98	98		
	SPA Pack length x width	cm	153 x 82	153 x 82		
	SPA Pack height	cm	106/110	106/110		
	SPA Pack max distance	m	6	6		
	Low compensation tank dimension	cm	200x90x62	200x90x62		
	Low compensation tank capacity	l	850	850		
	Standard compensation tank dimension	cm	100x120x130	100x120x130		
	Standard compensation tank capacity	l	850	850		
Weights and capacity	Average fill	l	1700	1700		
	Water capacity (total volume)	l	2100	2100		
	Net weight	kg	250	250		
	Total max weight	kg	2350	2350		
	Spa floor load	kg/m ²	2080	2080		
	spa pack floor load	kg/m ²	285	285		
	low compensation tank load	kg/m ²	450	450		
	standard compensation tank load	kg/m ²	770	770		
Electrical requirements	Spa Pack		Single-phase	Single-phase	Threephase	
	Power supply European Standard		380/415V 3F+N	380/415V 3F+N	380/415V 3F+N	
	Power supply Others		220/240V F+N	220/240V 3F	220/240V 3F	
	Max. absorption with electric heater	kW	5.7	5.7	17	
	Max. absorption without electric heater	kW	2.6	2.6	5	
	Electric heater	kW	3	3	12	
Heater exchanger	kcal/l	2.6	2.6	5		
Pumps	Pump 1		2.5 HP/1.8kW - 1 speed	2.5 HP/1.8kW - 1 speed	3 HP/2.2kW - 1 speed	
	Pump 2		--	2.5 HP/1.8kW - 1 speed	3 HP/2.2kW - 1 speed	
	Filtration Pump		0.75HP/0.56kW	0.75HP/0.56kW	0.75HP/0.56kW	
Water Management System	Skimmer Typology		External Grid	External Grid	External Grid	
	Filters		Sand Filter - 1 l m ³ /h	Sand Filter - 1 l m ³ /h	Sand Filter - 1 l m ³ /h	
Features	Installation		●	●	●	
	Seats		6	6	6	
	Lounge		1	1	1	
	Jets		18	38	38	
	Blowers		--	15	15	
	Light System (multicolor)		●	●	●	
	Automatic Water fill-up		●	●	●	
	Aromatherapy		--	●	●	
	w/compensation tank (standard)		●	●	●	
	w/compensation tank (lowered)		●	●	●	
	w/o compensation tank		●	●	●	
	Spa pack single phase w/o heater		●	●	●	
	Spa pack single phase w/heater		●	●	●	
	Spa pack single phase w/heat exchanger		●	●	●	
	Spa pack three phase w/o heater		--	●	●	
	Spa pack three phase w/heater		--	●	●	
	Spa pack three phase w/heat exchanger		--	●	●	
	Optional features	Ozone generator		optional	optional	
		Spa Pack booster kit		optional	optional	
Colours (shell)	White		●	●	●	
	Cobalt		●	●	●	
	Platinum		●	●	●	
Covers	Ice (leatherette)		●	●		

Jets ● Included ○ Please contact your local retailer for specifications

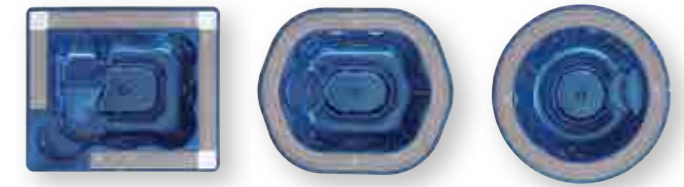

Features/Technical Data

			Virginia Experience	Sienna Experience	Alimia Experience	
Dimensions	Length	cm	257	257	Ø 237	
	Width	cm	219	219		
	Height	cm	98	98	98	
	SPA Pack length x width	cm	153 x 82	153 x 82	153 x 82	
	SPA Pack height	cm	106/110	106/110	106/110	
	SPA Pack max distance	m	6	6	6	
	Low compensation tank dimension	cm	--	--	--	
	Low compensation	l	--	--	--	
	Standard compensation tank dimension	cm	120x100x116	120x100x116	120x100x116	
	Standard compensation tank capacity	l	800	800	800	
Weights and capacity	Average fill	l	1700	1430	1350	
	Water capacity (total volume)	l	2100	1760	1660	
	Net weight	kg	250	200	180	
	Total max weight	kg	2350	1960	1840	
	Spa floor load	kg/m ²	2063	1643	2080	
	spa pack floor load	kg/m ²	260	260	260	
	low compensation tank load	kg/m ²	--	--	--	
	standard compensation tank load	kg/m ²	770	770	770	
Electrical requirements	Spa Pack		Threephase	Threephase	Threephase	
	Power supply European Standard		380/415V 3F+N	380/415V 3F+N	380/415V 3F+N	
	Power supply Others		220/240V 3F	220/240V 3F	220/240V 3F	
	Max. absorption with electric heater	kW	17	17	17	
	Max. absorption without electric heater	kW	5	5	5	
	Electric heater	kW	12	12	12	
Heater exchanger	kcal/l	5	5	5		
Pumps	Pump 1		3 HP/2.2kW - 1 speed	3 HP/2.2kW - 1 speed	3 HP/2.2kW - 1 speed	
	Pump 2		3 HP/2.2kW - 1 speed	3 HP/2.2kW - 1 speed	3 HP/2.2kW - 1 speed	
	Filtration Pump		0.75HP/0.56kW	0.75HP/0.56kW	0.75HP/0.56kW	
Water Management System	Skimmer Typology		External Grid	External Grid	External Grid	
	Filters		Sand Filter - 1 l m ³ /h	Sand Filter - 1 l m ³ /h	Sand Filter - 1 l m ³ /h	
Features	Installation		--	--	--	
	Built-in		●	●	●	
	Seats		6-7	7-8	6-7	
	Lounge		1	--	--	
	Jets		34	30	28	
	Blowers		16	16	16	
	Light System (white)		--	--	--	
	Light System (multicolor)		●	●	●	
	Automatic Water fill-up		●	●	●	
	Aromatherapy		●	●	●	
	w/compensation tank (standard)		●	●	●	
	w/compensation tank (lowered)		--	--	--	
	w/o compensation tank		●	●	●	
	Spa pack three phase w/o heater		●	●	●	
	Spa pack three phase w/heater		●	●	●	
	Spa pack three phase w/heat exchanger		●	●	●	
	Optional features	Ozone generator		optional	optional	optional
		Spa Pack booster kit		optional	optional	optional
	Colours (shell)	White		●	●	●
Cobalt			●	●	●	
Platinum			●	●	●	
Covers	Ice (leatherette)		●	●	●	

Jets ● Included ○ Please contact your local retailer for specifications

JACUZZI EUROPE S.p.A.

Socio Unico
Direzione e Coordinamento
Jacuzzi Brands, Corp. (USA)
S.S. Pontebbana Km 97,200
33098 Valvasone (PN) Italia
Tel. +39-0434-859111
Fax +39-0434-85278
www.jacuzzi.eu
info@jacuzzi.it

JACUZZI BATHROOM ESPAÑA S.L.

Sociedad unipersonal
A Company of
Jacuzzi Brands, Corp. (USA)
Comte Urgell, 252
08036 Barcelona
Telf. +34 93 2385031
Fax +34 93 2385032
www.jacuzzi.es
info-es@jacuzzi.it

JACUZZI SPA & BATH LIMITED

Jacuzzi Spa and Bath Limited
Old Mill Lane
Low Road
Hunslet
Leeds
LS10 1RB
Tel. +44 (0)113 272 7441
www.jacuzzi.co.uk
hottubsales@jacuzziemea.com

JACUZZI WHIRLPOOL GmbH

Humboldtstr. 30/32
D-70771 Leinfelden-Echterdingen
Deutschland
Tel. +49 (0)711 933247-40
Fax +49 (0)711 933247-50
www.jacuzzi.de
info-de@jacuzzi.it

JACUZZI FRANCE SAS

8, route de Paris
03305 CUSSET
FRANCE
Tél: +33 (0)4 70 30 90 50
Fax +33 (0)4 70 97 41 90
www.jacuzzi-france.com
info@jacuzzi-france.com

To install product always refer to the technical datasheets and instructions manuals available for download from www.jacuzzi.eu

The data and information given here are not binding for Jacuzzi, which reserves the right to make any modifications necessary without prior notice or replacements.

Foto: Gianni Antoniali/Ikon, Alessandro Paderni/Eye Studio
Render 3D: Neiko srl
Concept and graphic project: The Ad Store Italia

