

MATERIAL SPECIFICATION

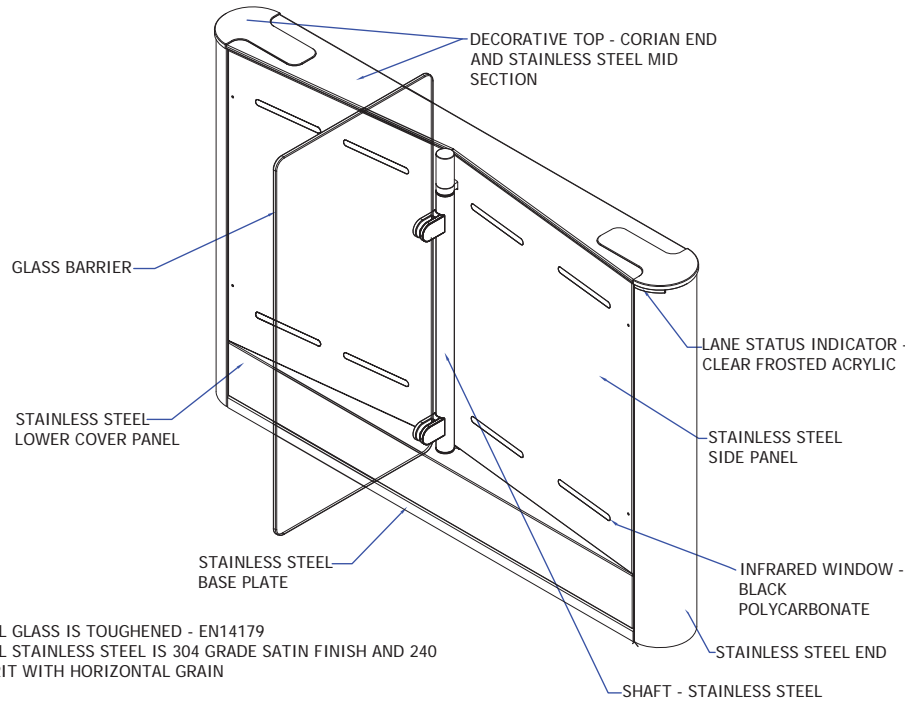

LANE LAYOUT & GENERAL DIMENSIONS

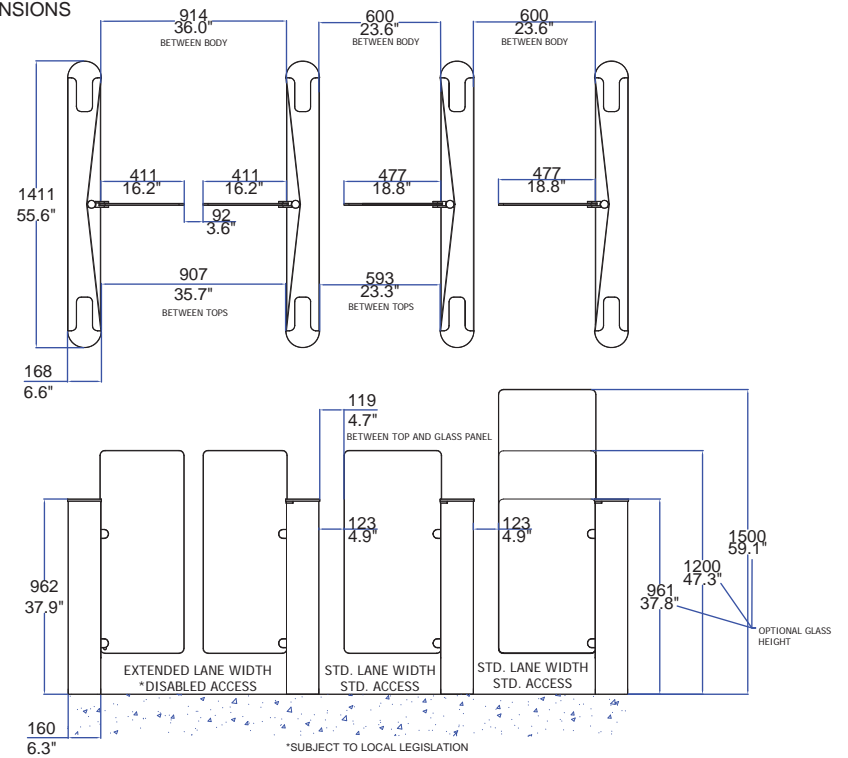

READER MOUNTING OPTIONS

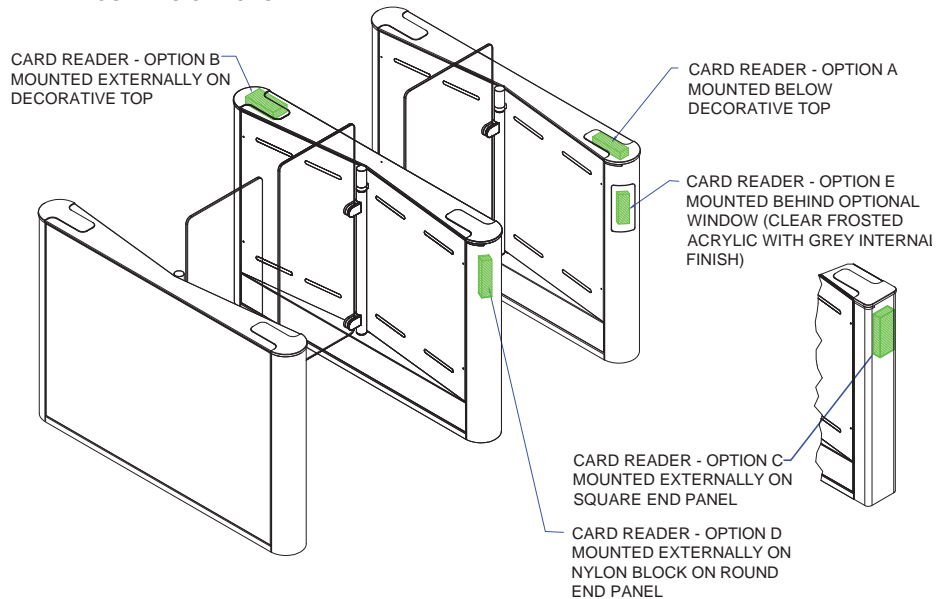

PEDESTAL FOOTPRINT

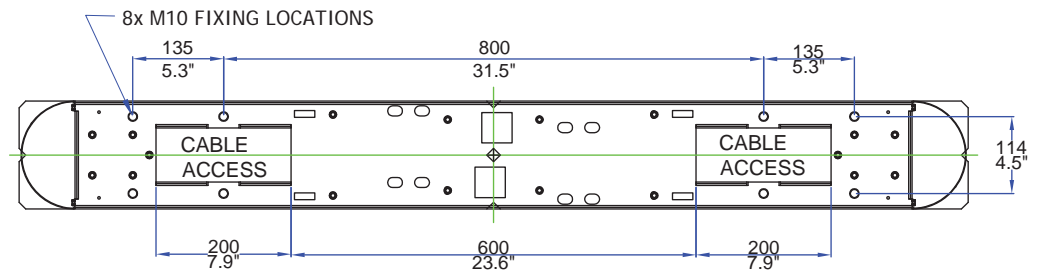

PRODUCT: GLASSGATE 200

TITLE: GENERAL INFORMATION

DRAWING No: GG200V3_A1

FOR SALES INFORMATION ONLY-SUBJECT TO CHANGE
 ALL DIMENSIONS +/-2mm

This document is the copyright of Integrated Design LTD

