

# installation and servicing

## **i**max xtra

Your Ideal installation and servicing guide

See reverse for **i**max xtra users guide

**Models F320, F400, F480, F560**

When replacing any part on this appliance, use only spare parts that you can be assured conform to the safety and performance specification that we require. Do not use reconditioned or copy parts that have not been clearly authorised by Ideal Boilers.

August 2010 UIN 202863 A07

**i** Ideal BOILERS  
The High Efficiency Pioneers

# GENERAL

**Table 1 Performance Data**

Boiler			F320	F400	F480	F560
Boiler output (non-condensing)	Max	kW	311.6	390.8	469.0	547.2
		Btu/h	1,063,200	1,333,400	1,600,200	1,867,000
Mean 70°C	Min	kW	67.8	97.7	105.5	107.7
		Btu/h	231,300	333,400	360,000	367,500
Boiler output (condensing)	Max	kW	329.0	415.6	498.8	581.8
		Btu/h	1,122,500	1,418,000	1,701,900	1,985,100
Mean 40°C	Min	kW	75.3	107.5	116.1	118.3
		Btu/h	256,900	366,800	396,100	403,600
Boiler Input Max Rate	Net	kW	320	400	480	560
		Btu/h	1,091,800	1,364,800	1,637,800	1,910,700
	Gross	kW	355.4	444.2	533.0	621.8
		Btu/h	1,212,600	1,515,600	1,818,600	2,121,600
Boiler Input Min Rate	Net	kW	70	100	108	110
		Btu/h	238,800	341,200	368,500	375,300
	Gross	kW	77.6	110.9	119.8	122.0
		Btu/h	264,800	378,400	408,800	416,300
Maximum Gas Rate		m³/h	32.2	40.2	48.4	56.4
		ft³/h	1138	1420	1710	1992
Approx. flue gas volume (@80°C) i.e. non-condensing	@ max. rate	m³/h	484	604	726	846
		ft³/h	17,100	21,380	25,640	29,920
Max. Flue Resistance		Pa	145	145	145	145
Flue Gas CO <sub>2</sub> G20/LNG	@ Max Rate	%	9.3/9.8	9.3/9.8	9.3/9.8	9.3/9.8
	@ Min. Rate	%	9.1/9.6	9.1/9.6	9.1/9.6	9.1/9.6
NOx with O <sub>2</sub> = 0%		mg/kWh	35	26	26	26
		ppm	20	15	15	15
Seasonal Boiler Efficiency (Building Regs L2)			95.1	95.2	95.2	95.2

**Table 2 General Data**

Boiler			F320	F400	F480	F560
Gas supply			2H - G20 - 20mbar			
Gas supply connection	(in. BSP)		2 x R1	2 x R1	2 x R1	2 x R1
Flow connection	(in. BSP)		2 x R2	2 x R2	2 x R2	2 x R2
Return connection	(in. BSP)		2 x R2	2 x R2	2 x R2	2 x R2
Hydraulic Resistance @ 20°C (with optional water header pack fitted)		mbar	100	105	110	120
Max Press (sealed system)		bar (psi)	6 (87)	6 (87)	6 (87)	6 (87)
Maximum Static Head		m (ft)	61 (200)	61 (200)	61 (200)	61 (200)
Boiler Electricity Supply			230V - 50Hz			
Boiler Fuse Rating			2 x External 5A supplies Internal 2AT.4AT (x2)			
Power Consumption (boiler only)		W	800	800	800	800
Air Inlet	O/D	m m	110x2	110x2	110x2	110x2
Flue Size dia		m m	200	250	250	250
Condensate drain		m m	2x21.5	2x21.5	2x21.5	2x21.5
Boiler dry weight (unpacked exc. headers)		kg (lb)	336 (740)	396 (874)	430 (948)	466 (1028)
Water Content		l (gal)	35 (7.8)	36.8 (8.2)	48.0 (10.6)	54.4 (12.0)

Electricity supply and Fuse rating for pumps etc. refer to manufacturer's instructions.

\* **OPTIONAL HEADER PACK HAS DN80 CONNECTIONS FOR FLOW AND RETURN AND 2" BSP GAS CONNECTION**

**Note.**

Natural gas consumption is calculated using a calorific value of 37.8MJ/m<sup>3</sup> (1038Btu/ft<sup>3</sup>) gross or 34 MJ/m<sup>3</sup> (910 Btu/ft<sup>3</sup>) nett at 15°C and 1013.25 mbar.

- a. For l/s divide the gross heat input (kW) by the gross C.V. of the gas (MJ/m<sup>3</sup>)
- b. For ft<sup>3</sup>/h divide the gross heat input (Btu/h) by the gross C.V. of the gas (Btu/ft<sup>3</sup>).

**HEALTH & SAFETY DOCUMENT NO. 635**

The electricity at work regulations, 1989. The manufacturer's notes must NOT be taken, in any way, as overriding statutory obligations.

**IMPORTANT.** These appliances are CE certified for safety and performance. It is, therefore, important that no external control devices, e.g. flue dampers, economisers etc., are directly connected to these appliances unless covered by these Installation and Servicing Instructions or as otherwise recommended by **Ideal Stelrad Group** in writing. If in doubt please enquire.

Any direct connection of a control device not approved by **Ideal Stelrad Group** could invalidate the certification and the normal appliance warranty. It could also infringe the Gas Safety Regulations and the above regulations.

**CAUTION. To avoid the possibility of injury during the installation, servicing or cleaning of this appliance, care should be taken when handling edges of sheet steel components.**

## CONTENTS

Boiler Assembly - exploded view .....	11
Boiler Clearances .....	9
Boiler Dimensions .....	7,8,9
Commissioning and Testing .....	37
Electrical Connections .....	18
Electrical Supply .....	6
Fault Finding .....	50
Flue Installation .....	5
Gas Safety Regulations .....	4
Gas Supply .....	4
Hydraulic Resistance .....	5
Initial Lighting .....	37
Installation .....	11
Option Kits .....	4
Performance Data .....	2
Servicing .....	38
Short List of Parts .....	54
Ventilation .....	9
Water Circulation .....	6
Water Connections .....	17
Water System Requirements .....	10
Water Treatment .....	6
Wiring Diagrams .....	21,22

### **imax xtra**

**Natural Gas only**

**PI No. 0063 BR 3123**

**Destination Countries: GB, IE**

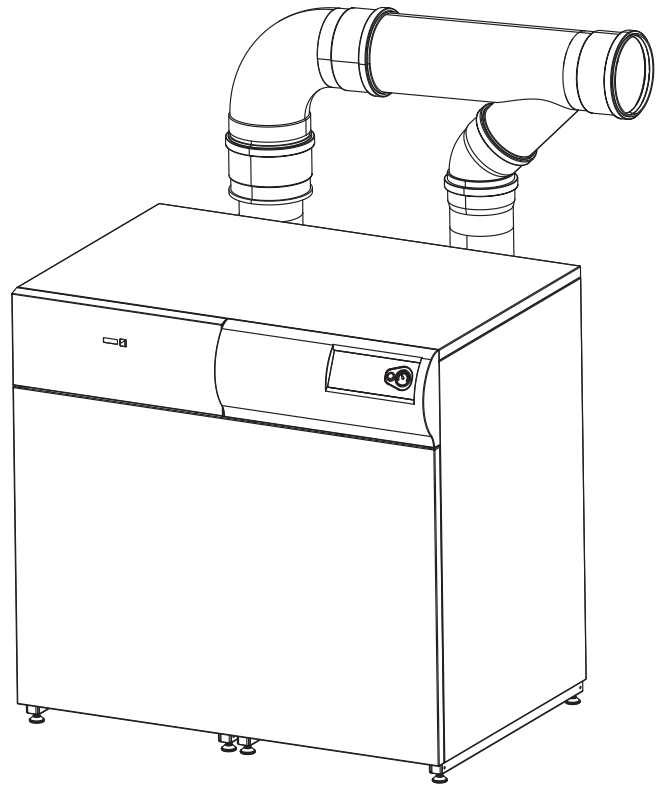

#### **Key to symbols**

- IE = Ireland, GB = United Kingdom (Countries of destination)
- PMS = Maximum operating pressure of water
- C53 = A room sealed appliance which is connected via its separate ducts to two terminals that may terminate in zones of different pressure.
- C63 = A room sealed appliance intended to be connected to a separately approved and marketed system for the supply of combustion air and discharge of combustion products. The fan is up stream of the combustion chamber.
- B23 = An appliance intended to be connected to a flue which evacuates the products of combustion to the outside of the room containing the boiler. The combustion air is drawn directly from the room. The fan is up stream of the combustion chamber.

**NOTE TO THE INSTALLER: LEAVE THESE INSTRUCTIONS ADJACENT TO THE GAS METER.**

## INTRODUCTION

The **imax xtra** boilers are fully automatically controlled, floor standing, fanned, super efficient condensing appliances.

The imax xtra comprises of 2 modules, Master and Slave.

The comprehensive boiler controls built into the appliance include:

- 0-10V Boiler control input
- Volt free 'alarm' contacts (lockout)
- Volt free 'boiler run' contacts
- Burner hours run meters
- System temperature indication

The boilers can draw their combustion air from the room or via ducting from outside.

Through a sophisticated control system combined with premix burner technology and an aluminium heat exchanger, the boilers are capable of high operating efficiencies of 93% (gross) and low emissions.

These boilers are certified to meet the requirements of the EC Gas Appliance Directive, Boiler Efficiency Directive, EMC and Low Voltage Directive.

## OPTIONAL EXTRA KITS

- **Modulating Sequencer**
    - DHW Sensor
    - Room Sensor
  - **Programmable Room Stat**
  - **Outside Sensor**  
(only suitable for use in conjunction with Prog. Room Stat)
  - **Water and Gas Header Pack**
  - **RS Air Duct Connector** (F320 and F400 only)
  - **Horizontal Flue Header \***
  - **Vertical Flue Header \***
- \* A flue header kit (horizontal or vertical) must be fitted to boiler.

## SAFETY

Current Gas Safety (Installation and Use) Regulations or rules in force

The appliance is suitable only for installation in GB and IE and should be installed in accordance with the rules in force.

In GB, the installation must be carried out by a CORGI Registered Installer or in IE by a competent person. It must be carried out in accordance with the relevant requirements of the:

- Gas Safety (Installation and Use) Regulations
- The appropriate Building Regulations either The Building Regulations, The Building Regulations (Scotland), Building Regulations (Northern Ireland).
- The Water Fittings Regulations or Water byelaws in Scotland.
- The Current I.E.E. Wiring Regulations.

Where no specific instructions are given, reference should be made to the relevant British Standard Code of Practice.

In IE, the installation must be carried out by a Competent Person and installed in accordance with the current Building Regulations and reference should be made to the current ETCl rules for electrical installation.

The boilers have been tested by Gastec and conform to EN483 and EN677 for use with Natural Gas.

Detailed recommendations are contained in the following Standards and Codes of Practice:

BS. 5854	Flue and flue Structures in Buildings.
BS. 6644	Installation of gas fired hot water boilers of rated inputs between 70kW and 1.8MW (net) (2nd and 3rd family gases).
BS. 6880	Low temperature hot water heating systems of output greater than 45kW.
Part 1	Fundamental and design considerations.
Part 2	Selection of equipment.
Part 3	Installation, commissioning and maintenance.
IGE/UP/1	Soundness testing and purging of industrial and commercial gas installations.
IGE/UP/2	Gas installation pipework, boosters and compressors on industrial and commercial premises.
IGE/UP/10	Installation of gas appliances in industrial and commercial premises.

## SAFE HANDLING OF SUBSTANCES

No asbestos, mercury or CFCs are included in any part of the boiler or its manufacture.

## FOUNDATION / LOCATION OF BOILER

The boiler must stand on a floor which must be flat, level and of a suitable load bearing capacity to support the weight of the boiler (when filled with water) and any ancillary equipment.

Ideally the boiler should be placed on a plinth exceeding the plan area of the boiler by 75mm on each side and at least 100mm high.

**The boiler must not be fitted outside.**

## GAS SUPPLY

The local gas supplier should be consulted, at the installation planning stage, in order to establish the availability of an adequate supply of gas. An existing service pipe must NOT be used without prior consultation with the local gas supplier.

A gas meter can only be connected by the local gas supplier or by a registered CORGI engineer or in IE by a competent person.

An existing meter should be checked, preferably by the gas supplier, to ensure that the meter is adequate to deal with the rate of gas supply required. A minimum working gas pressure of 15mbar MUST be available at the boiler inlet for Natural gas.

Do not use pipes of smaller size than the boiler inlet gas connection.

The complete installation MUST be tested for gas soundness and purged in accordance with the appropriate standards.

### Gas Boosters

A gas booster is required if the gas pressure available at the boiler is lower than that required by the boiler manufacturer to attain the flow rate for maximum burner input rating.

Location of the booster requires careful consideration but should preferably be closer to the burner rather than the gas meter. Ventilation should also be considered to ensure ambient temperature do not exceed designed recommendations. Further guidance is provided in IGE/UP/2.

## FLUE INSTALLATION

The appropriate Ideal Flue Header Kit (vertical or horizontal) must be fitted to these boilers.

**IMPORTANT.** It is the responsibility of the installer to ensure, in practice, that products of combustion discharging from the terminal cannot re-enter the building or any other adjacent building through ventilators, windows, doors, other sources of natural air infiltration, or forced ventilation / air conditioning.

If this should occur the appliance **MUST** be isolated from the gas supply and labelled as 'unsafe' until corrective action can be taken.

### Terminal Position

Due to the high efficiency of the boilers pluming will occur.

Particular care should be taken in the case of large output boiler installations, and complying with the requirements of the Clean Air Act.

The flue must be installed in accordance with the appropriate Building Regulations and standards listed on page 4 and in compliance with BS6644. In IE refer to I.S.820:2000.

## FLUE SYSTEM DESIGN

Due to the high efficiency of these boilers, the flue gas temperatures are low and the buoyancy in the stack will be relatively small. The boiler is supplied with an integral fan which is fully matched to the boiler in each case to provide correct combustion air flow and overcome the flue resistance.

The power of this fan is such that there is a large reserve of pressure available to overcome a significant length of flue without affecting the combustion performance of the boiler. The maximum pressure available at the base of the flue to overcome flue resistance is 145Pa (0.58" w.g.) for F320, F400, F480 and F560. This includes the resistance of any air ducts used to connect the air inlet direct to outside air. Care should be taken with tall flue systems to ensure excess buoyancy is not created. A negative pressure must not be created at the boiler flue outlet.

See table below for approximate maximum straight flue length.

Boiler	F320	F400	F480	F560
Flue Size (mm)	Ø200	Ø250	Ø250	Ø250
Approx. max. Straight Flue Length (m)	109	235	162	116

If the high level air inlet kit, supplied with this appliance, is to be utilised, the following table shows the approximate maximum straight flue lengths and pressures available.

Boiler	F320	F400	F480	F560
Flue Size (mm)	Ø200	Ø250	Ø250	Ø250
Approx. max. Straight Flue Length (m)	57	129	67	40
Flue Pressure (Pa)	76	80	60	50

The addition of elbows and their positions in the flue will have a significant effect on the maximum allowable flue and air duct lengths. Consult with your flue supplier for detailed design work.

### IMPORTANT NOTE.

**If combustion air is drawn from within the boiler room, ensure no dust or airborne debris can be ingested into the appliance. Dusty concrete flooring should be sealed to reduce the presence of dust. Ideally where possible duct the air supply into the boiler room from a clean source outside the boiler room / building.**

### Material

With no requirement for buoyancy to discharge flue products and with low flue gas temperatures, single wall flues are suitable for most installations. Care should still be taken to maintain compliance with building regulations and relevant standards.

The flue used should be a suitably approved flue for use on a pressurised condensing flue system. Materials choice includes plastic, aluminium and 316 grade stainless steel. **Unless the flue is manufactured from aluminium, the condensate from the flue must be collected and drained before entering the sump of the boiler** (when employing the vertical combined flue outlet header, a flue condensate drain is provided for this purpose). Advice regarding the availability of proprietary types of flue system can be obtained by contacting **Ideal Stelrad Group**. All joints or connections in the flue system must be impervious to condensate leakage. Low points in the flue system should be drained using pipe of material resistant to condensate corrosion. All drains in the flue should incorporate a water trap.

Care should also be taken in the selection of flue terminals as these tend to accentuate the formation of a plume and could freeze in cold weather conditions.

Care should be taken to ensure the specification of the chimney is suitable for the application by reference to the manufacturers literature.

# GENERAL

## WATER CIRCULATION SYSTEM

A circulation pump **MUST** be connected to the boiler, see below.

The boiler must **NOT** be used for direct hot water supply. The hot water storage cylinder **MUST** be of the indirect type.

Single feed, indirect cylinders are not recommended and **MUST NOT** be used on sealed systems.

The appliances are **NOT** suitable for gravity central heating nor are they suitable for the provision of gravity domestic hot water.

The hot water cylinder and ancillary pipework, not forming part of the useful heating surface, should be lagged to prevent heat loss and any possible freezing - particularly where pipes run through roof spaces and ventilated underfloor spaces.

The boiler must be vented. There must be no low points between the boiler flow connection and a system vent point, which should be positioned as close as practically possible to the boiler flow connection.

Draining taps **MUST** be located in accessible positions, which permit the draining of the whole system - including the boiler and hot water storage vessel. They should be at least 1/2" BSP nominal size and be in accordance with BS. 2879. Do not use the boiler drain tap to drain the system as this can induce sludge into the heat exchanger.

The central heating system should be in accordance with the relevant standards listed on page 4.

Due to the compact nature of the boiler the heat stored within the castings at the point of shutdown of the burner must be dissipated into the water circuit in order to avoid overheating. In order to allow pump operation after burner shutdown the boiler control box incorporates a 5 minute pump overrun facility. In order to make use of this, a pump must be supplied from the terminals inside the boiler. Note: for pumps requiring greater than 1.0 amp current, they must be connected via a relay.

When sizing pumps, reference should be made to the Hydraulic Resistance Table on page 6 which show the boiler resistance against flow rates, to achieve the required temperature differential.

Flow rates for common systems using either 11°C or 20°C temperature differentials are given in the table below.

	Water flow rate temp. difference 11°C (20°F)		Water flow rate temp. difference 20°C (36°F)	
	l/s	m³/h	l/s	m³/h
<b>F320</b>	7.14	25.70	3.93	14.15
<b>F400</b>	9.02	32.47	4.96	17.86
<b>F480</b>	10.83	38.99	5.96	21.46
<b>F560</b>	12.63	45.47	6.95	25.02

### Note.

- *With the boiler firing at maximum rate, the temperature differential should not be less than 10°C. Higher flow rates required for lower temperature differentials could lead to erosion of the heat exchanger water ways.*
- *With the boiler firing at minimum rate, the temperature differential should not be greater than 35°C. Lower flow rates generating higher temperature differentials will lead to lock out of the boiler.*
- *The lower the return temperature to the boiler, the higher the efficiency. At return temperatures of 55°C and below, the difference becomes marked because the water in the flue gases starts to condense, releasing its latent heat.*

In installations where all radiators have been provided with thermostatic radiator valves, it is essential that water circulation through the boiler is guaranteed. A mixing header will perform this task. Alternatively this can be best achieved by means of a differential pressure valve, which is installed in a bypass

between the flow and return pipes. The bypass should be fitted at least 6m from the boiler, and should be capable of allowing a minimum flow rate to achieve a temperature differential of no greater than 35°C at minimum rate.

## WATER TREATMENT

**These boilers incorporate an ALUMINIUM heat exchanger.**

**IMPORTANT.** The application of any other treatment to this product may render the guarantee of **Ideal Stelrad Group** INVALID.

**Ideal Stelrad Group** recommend Water Treatment in accordance with Guidance Notes on Water Treatment in Central Heating Systems.

**Ideal Stelrad Group** recommend the use of Fernox Copal or MB1 or GE Betz Sentinel X100 inhibitors and associated water treatment products, which must be used in accordance with the manufacturers' instructions.

For further information contact:

**Fernox Manufacturing Co. Ltd.**, Cookson Electronics, Forsyth Road, Sheerwater, Woking, Surrey, GU21 5RZ  
Tel: +44 (0) 1799 521133 or

**Sentinel Performance Solutions.**,

The Heath Business & Technical Park, Runcorn, Cheshire, WA7 4QX  
Tel: 0800 389 4670. [www.sentinel-solutions.net](http://www.sentinel-solutions.net)

1. *It is most important that the correct concentration of the water treatment products is maintained in accordance with the manufacturers' instructions.*
2. *If the boiler is installed in an existing system any unsuitable additives **MUST** be removed by thorough cleansing.*
3. *In hard water areas, treatment to prevent limescale may be necessary - however the use of artificially softened water is **NOT** permitted.*
4. *Under no circumstances should the boiler be fired before the system has been thoroughly flushed.*

## ELECTRICAL SUPPLY

**WARNING. This appliance must be earthed.**

Wiring external to the appliance **MUST** be in accordance with the current I.E.E. (BS7671) Wiring Regulations and any local regulations which apply. For Ireland reference should be made to the current ETCI rules for electrical installations.

The point of connection to the mains should be readily accessible and adjacent to the boiler.

## CONDENSATE DRAIN

Condensate drains are provided on the boiler. These drains must be connected to a drainage point on site. All pipework and fittings in the condensate drainage system **MUST** be made of plastic - no other materials may be used.

**IMPORTANT.** Any external runs must be insulated to avoid freezing in cold weather causing blocking.

## HYDRAULIC RESISTANCE - (with optional water header pack fitted)

Boiler	Pressure Drop (mbar) @ 20°C	Pressure Drop (mbar) @ 11°C
F320	100	327
F400	105	354
F480	110	388
F560	120	425

**1 BOILER DIMENSIONS AND CONNECTIONS - HORIZONTAL FLUE CONNECTION KIT FITTED**

All dimensions shown in mm

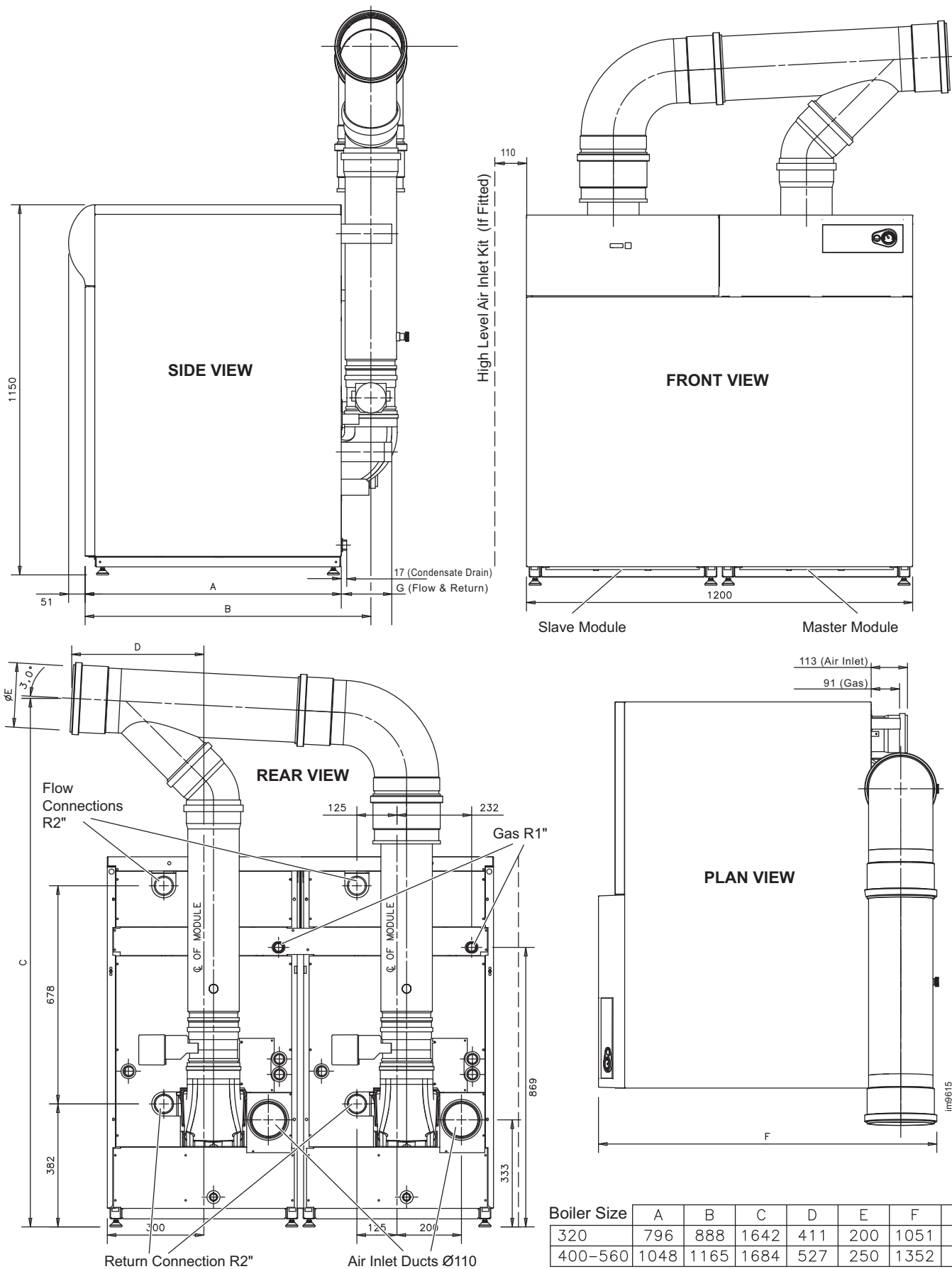

Boiler Size	A	B	C	D	E	F	G
320	796	888	1642	411	200	1051	157
400-560	1048	1165	1684	527	250	1352	227

# GENERAL

## 1 CONT'D...BOILER DIMENSIONS AND CONNECTIONS - VERTICAL FLUE CONNECTION KIT FITTED

All dimensions shown in mm

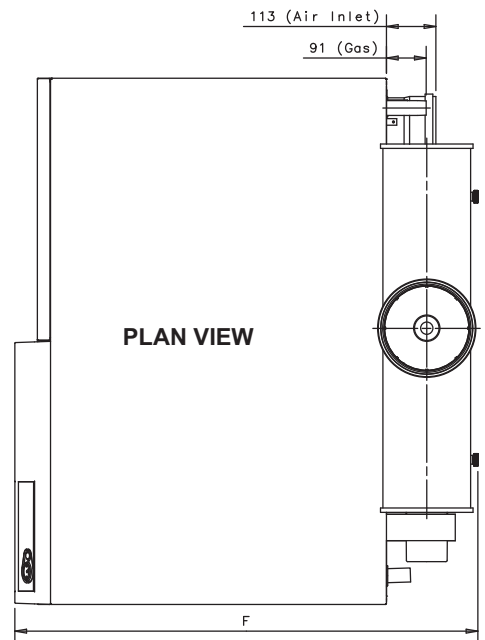
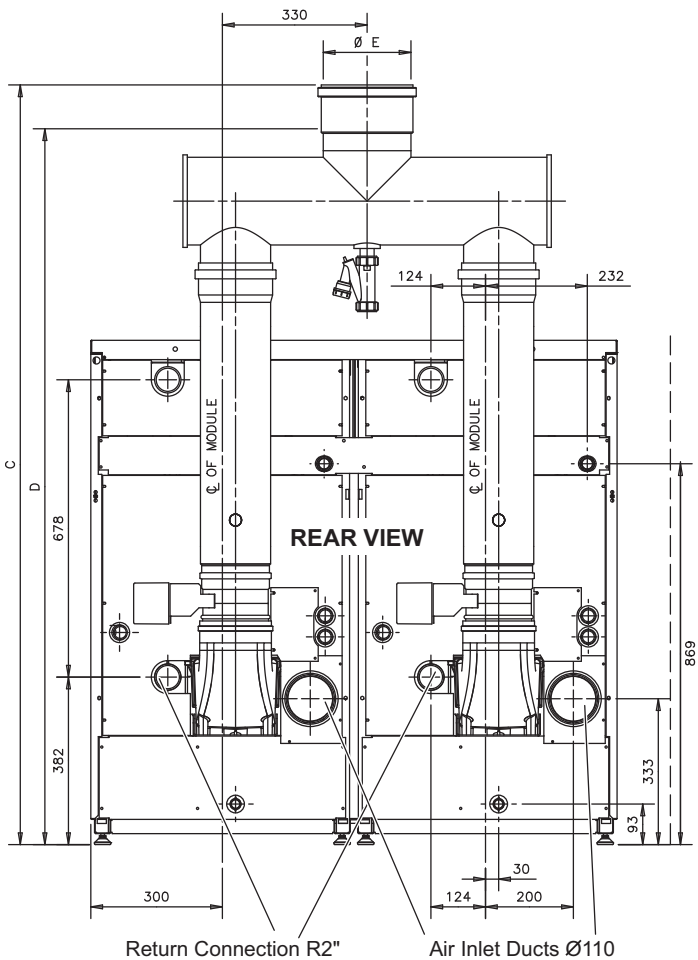
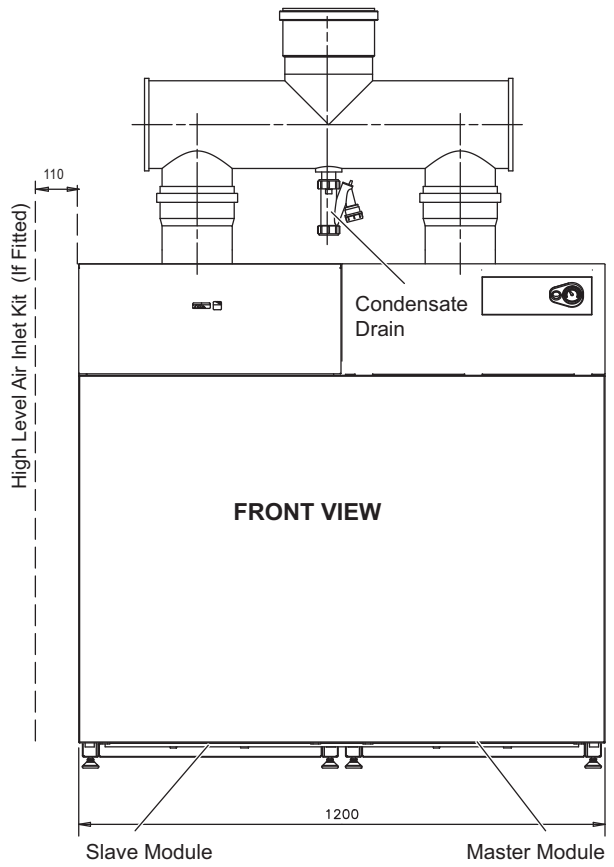
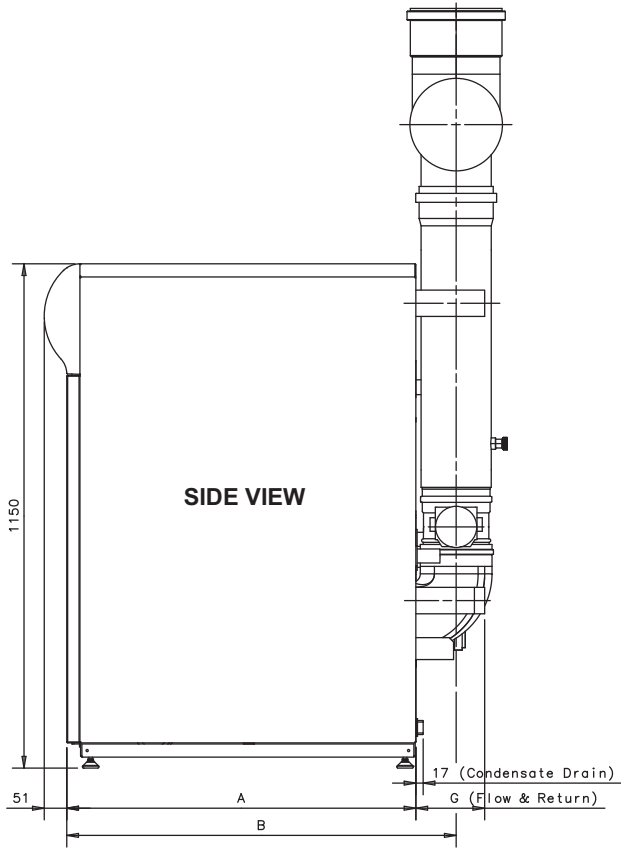

Boiler Size	A	B	C	D	E	F	G
320	796	888	1732	1632	200	1056	157
400-560	1048	1165	1524	1424	250	1353	227

im9616

# GENERAL

## 2 BOILER DIMENSIONS AND CONNECTIONS

(Optional water and gas header kit and rs air duct connector (F320 & F400 only) fitted)

Note. F320 Model shown

All dimensions shown in mm

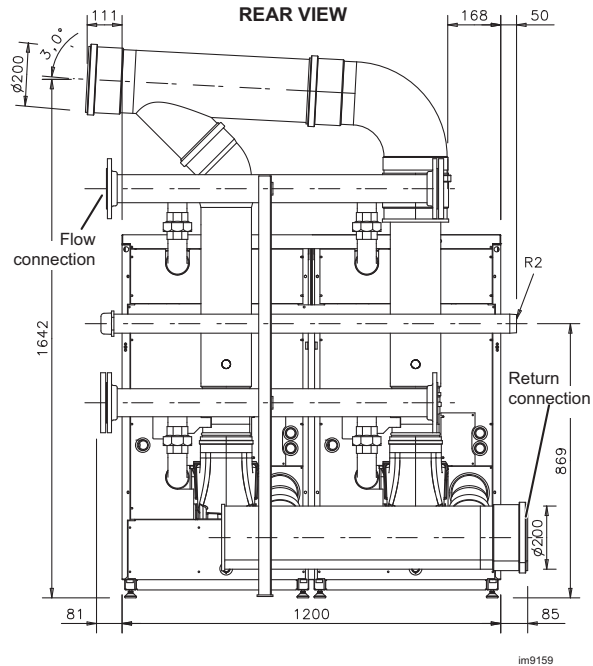
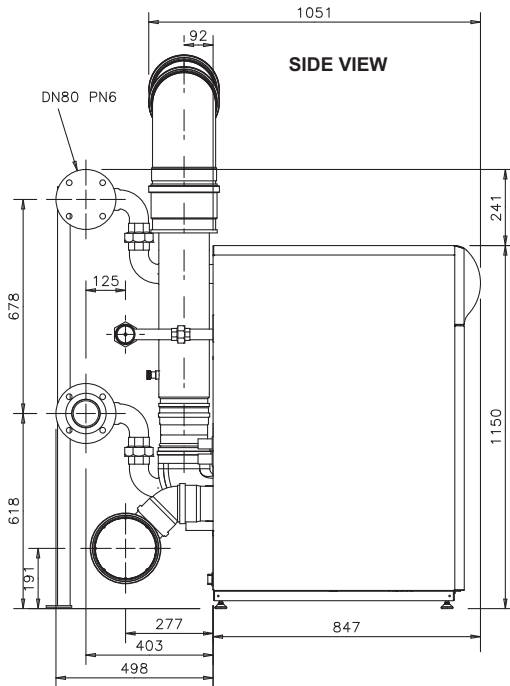

## 3 BOILER CLEARANCES

The minimum dimensions as indicated must be respected to ensure good access around the boiler.

Recommended minimum clearances are as follows.

**Rear:** 1000mm or adequate space from the rear of the jacket to make the flue connections and access to the flue sample point, drain connection, flue and any safety or control devices.

**Left Side:** 450mm

**Right Side:** 450mm

**Front:** 600mm; except, access doors may be closer, but not less than 200mm and 600mm must still be available for service across the width of the boiler.

**Top:** 500mm.

## 4 VENTILATION

The ventilation requirements of these boilers are dependant on the type of flue system used, and their heat input. All vents must be permanent with no means of closing, and positioned to avoid accidental obstructions by blocking or flooding.

Detail reference should be made to BS. 6644 for inputs between 70kW and 1.8MW (net). In IE refer to the current edition of I.S.820. The following notes are for general guidance only:

Dust contamination in the combustion air may cause blockage of the burner slots. Unless the boiler room provides a dust free environment then direct connection of the air intake via ducting to clean outside air should be used.

### IMPORTANT NOTE.

**If combustion air is drawn from within the boiler room, ensure no dust or airborne debris can be ingested into the appliance. Dusty concrete flooring should be sealed to reduce the presence of dust.**

The temperature within a boiler room shall not exceed 25°C within 100 mm of the floor, 32°C at mid height and 40°C within 100 mm of the ceiling.

### Open Flued Installations

If ventilation is to be provided by means of permanent high and low vents communicating direct with outside air, then reference can be made to the sizes below. For other ventilation options refer to BS. 6644. In IE refer to the current edition of I.S.820.

### Required area (cm<sup>2</sup>) per kW of total rated input (net)

	Boiler Room	Enclosure
Low level (inlet)	4	10
High level (outlet)	2	5

Note: Where a boiler installation is to operate in summer months (e.g. DHW) additional ventilation requirements are stated, if operating for more than 50% of time (refer to BS6644).

### Room Sealed Installations

A minimum of 2cm<sup>2</sup> free area per kW of net heat input at both high and low level is required for boiler rooms. For enclosures refer to BS6644.

## 5 OPEN VENTED SYSTEM REQUIREMENTS

Detail reference should be made to the appropriate standards listed on page 4.

The information and guidance given below is not intended to override any requirements of the above publications or the requirements of the local authority, gas or water undertakings.

The vertical distance between the pump and feed/expansion cistern **MUST** comply with the pump manufacturer's minimum requirements, to avoid cavitation. Should these conditions not apply either lower the pump position or raise the cistern above the minimum requirement specified by **Ideal Stelrad Group**. The isolation valves should be fitted as close to the pump as possible.

The information provided is based on the following assumptions:

1. An independent open vent/safety pipe connection is made immediately after the system flow pipe connection.
2. An independent cold feed/expansion pipe connection is made immediately after the open vent/safety pipe connection.
3. The maximum flow rate through the boiler is based on a temperature difference of 11°C at full boiler output.
4. The boiler is at the highest point of circulation in the system. Systems designed to rise above the boiler flow tappings will automatically require a minimum static head higher than that shown.
5. The position of the open vent/safety pipe above the expansion cistern water level is given as a guide only. The final position will depend upon the particular characteristics of the system. Pumping over of water into the expansion cistern must be avoided.
6. Both open vent/safety pipe and cold feed/expansion pipes must be of adequate diameter to suit the output of the boiler. Refer to Tables below and BS 6644:2005.

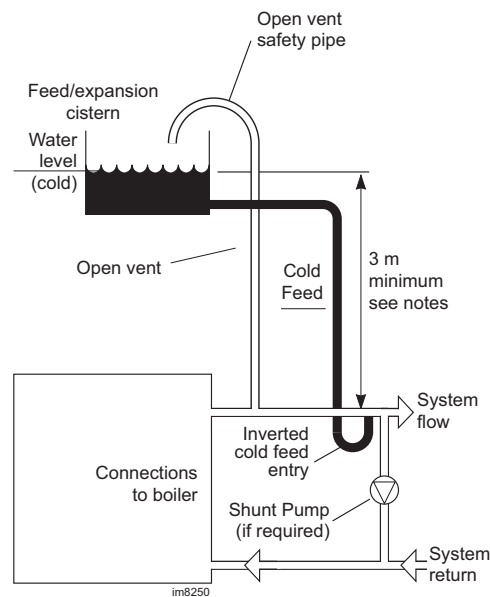

**Note.**

- With a cold feed head of <8m, the pump must be fitted on the return to the boiler.
- This diagram does not show safety valves, water flow switches, etc. necessary for the safe operation of the system.

### Open Vent Pipe Sizes

Rated output kW	Minimum bore mm	Nominal Size (DN) in
301 to 600	50	2

'Steel pipe sizes complying with medium or heavy quality or BS 1387.

### Cold Feed Pipe Sizes

Rated output kW	Minimum bore mm	Nominal Size (DN) in
301 to 600	38	1 1/2

'Steel pipe sizes complying with medium or heavy quality or BS 1387.

**Note.** Refer to Frame 29 for typical system arrangements.

## 6 SEALED SYSTEM REQUIREMENTS

### Working pressure 6 bar maximum.

Particular reference should be made to BS. 6644 and Guidance note PM5 "Automatically controlled steam and hot water boilers" published by the Health and Safety Executive.

The information and guidance given below is not intended to override any requirements of either of the above publications or the requirements of the local authority, gas or water undertakings.

In general commercial closed pressurised systems are provided with either manual or automatic water make up.

In both instances it will be necessary to fit automatic controls intended to protect the boiler, circulating system and ancillary equipment by shutting down the boiler plant if a potentially hazardous situation should arise.

Examples of such situations are low water level and operating pressure or excessive pressure within the system. Depending on circumstances, controls will need to be either manual or automatic reset. In the event of a shutdown both visual and audible alarms may be necessary.

Expansion vessels used must comply with BS. 4814 and must be sized on the basis of the total system volume and initial charge pressure.

Initial minimum charge pressure should not be less than 0.5 bar (7.2psi) and must take account of the static head and specification of the pressurising equipment. The maximum water temperatures permissible at the point of minimum pressure in the system are specified in Guidance Note PM5.

When make up water is not provided automatically it will be necessary to fit controls which shut down the plant in the event of the maximum system pressure approaching to within 0.35bar (5psi) of the safety valve setting.

Other British Standards applicable to commercial sealed systems are:

- BS. 6880: Part 2
- BS. 1212
- BS. 6281: Part 1
- BS. 6282: Part 1
- BS. 6283: Part 4

## 7 BOILER ASSEMBLY

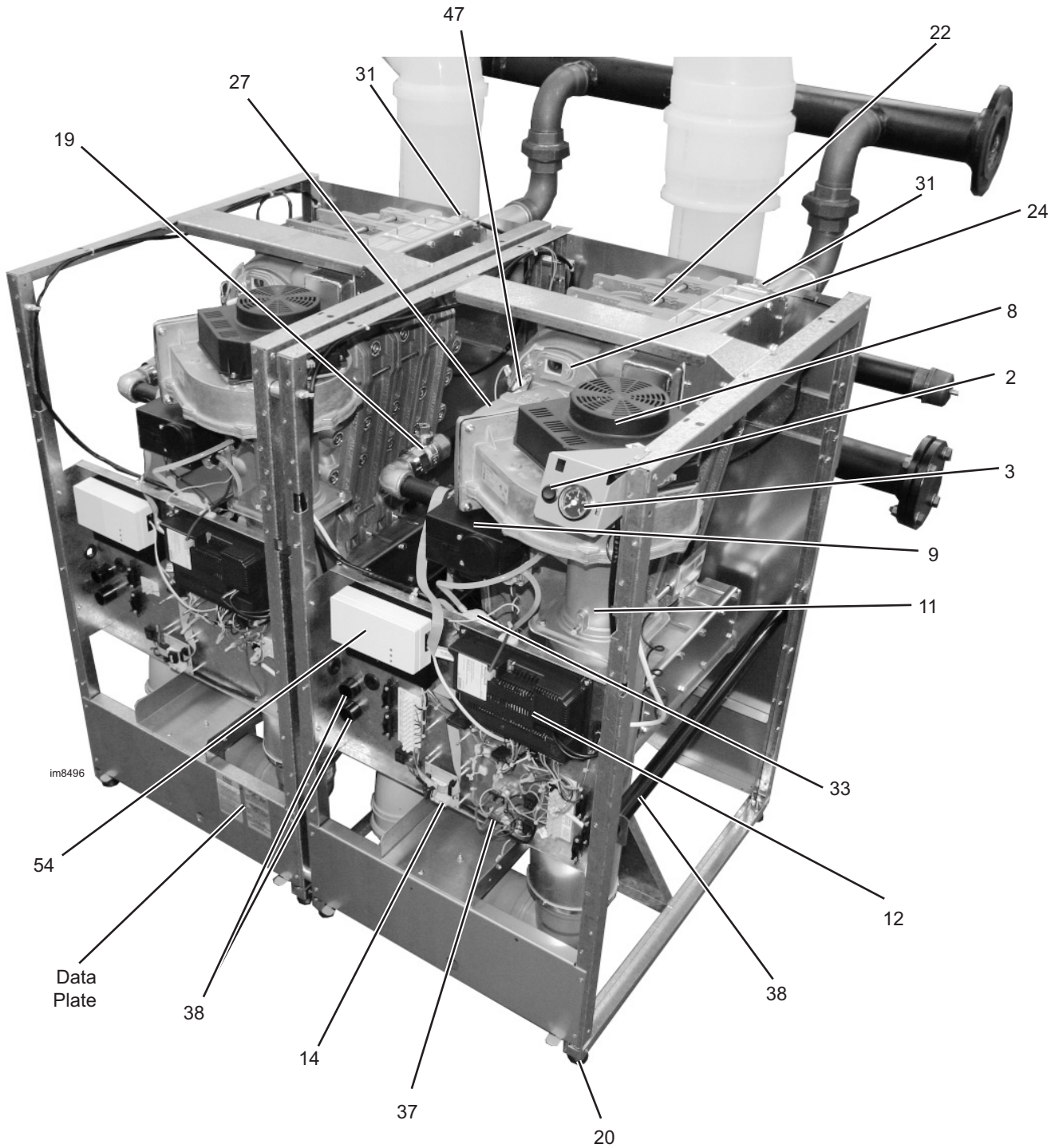

**Legend**

- |  |   |   |
|--|---|---|
| <ul style="list-style-type: none"> <li>2. Burner switch</li> <li>3. Pressure gauge</li> <li>8. Fan</li> <li>9. Gas Valve</li> <li>11. Venturi</li> <li>12. Control Module</li> </ul> | <ul style="list-style-type: none"> <li>14. Damper Relay Board</li> <li>19. Union Gas cock</li> <li>20. Levelling feet</li> <li>22. Heat exchanger</li> <li>24. Sightglass</li> <li>27. Burner manifold</li> </ul> | <ul style="list-style-type: none"> <li>31. Thermistor (flow)</li> <li>33. Air pressure switch</li> <li>37. Relay</li> <li>38. Cable conduit</li> <li>47. Ignition / detection electrode</li> <li>54. OT Center</li> </ul> |
|--|---|---|

# INSTALLATION

## 8 PACKAGING REMOVAL / REMOVAL FROM PALLET

The boiler comprises of an equally sized Master and Slave Module, separately packed on their own pallets. This allows the boiler to be handled by a forklift.

The packaged boiler will pass through a 930mm wide opening. Removing the casing assembly pack from the Master Module will allow Modules through a 700mm wide opening.

### To unpack the modules:

- Carefully remove the straps, and lift off the casing assembly pack - master only.
- Open Master Module box and remove literature pack.
- Remove the protective cardboard fittings.
- Safely dispose of all packing materials.

### To remove the Modules from base:

1. Remove 2 screws securing casing support outrigger and discard item (Master only).
2. Remove the 3 front screws (2 screws on 320 model) on both sides leaving the 2 rear screws in place.
3. Rotate bottom battens outwards allowing the front of the base to rest on the floor.
4. Remove 4 screws and retaining brackets.
5. Slide the module off the base.

*Repeat Steps 2 - 5 for slave module.*

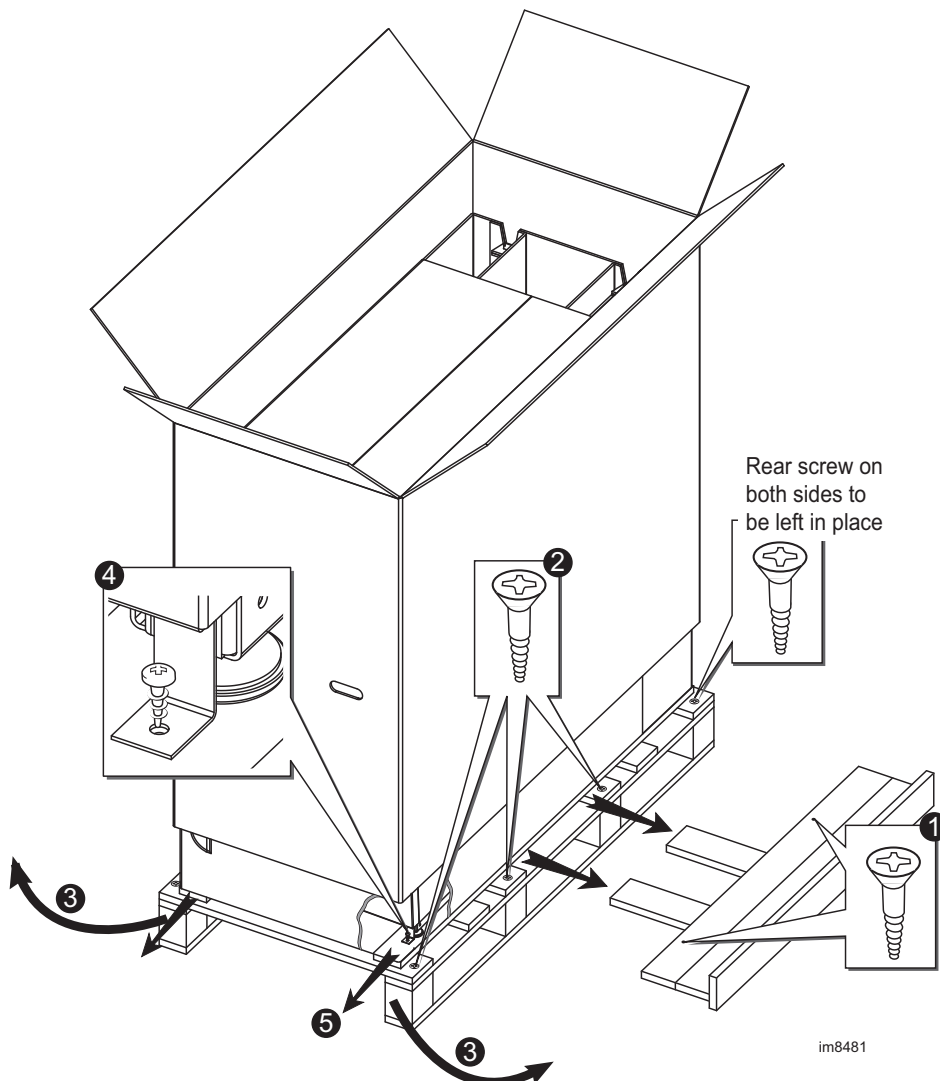

## 9 ASSEMBLING THE MODULES

1. Fit spacers x 4 to the LH side corners of the Master Module chassis (located inside casing assembly pack).

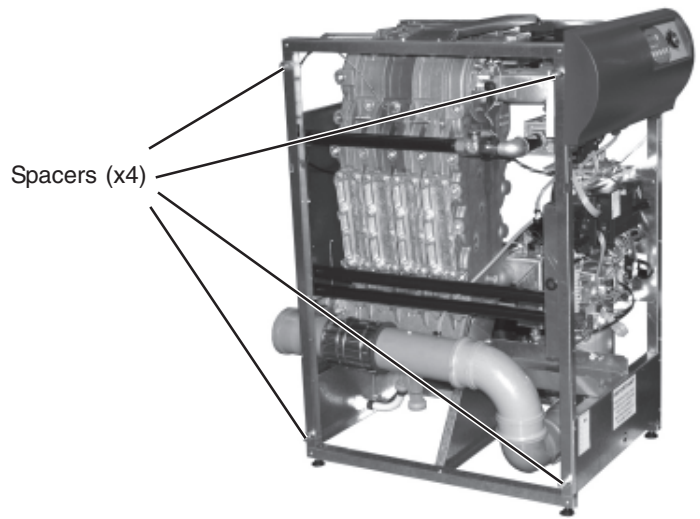
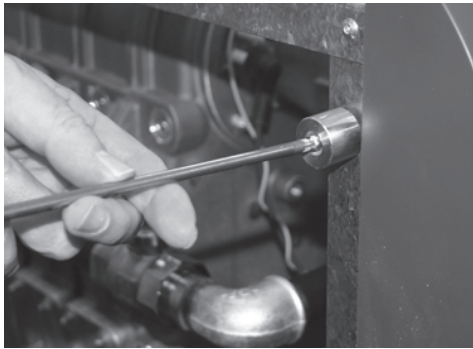

2. **Control Fascia Panel - Master Module:** Remove the 2 screws securing the control fascia panel. Carefully lift it slightly and lower the top forwards allowing it to rest on the hinge lugs.



3. Release the ribbon cable from the display board. Raise control fascia slightly and withdraw. Store safely.

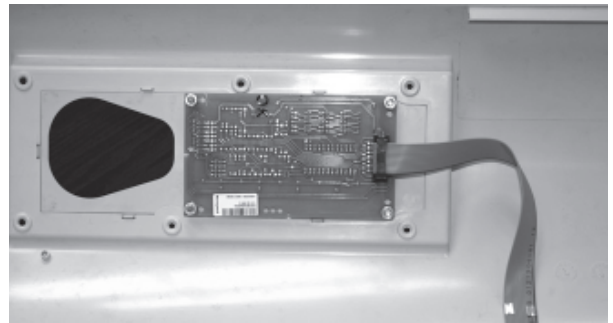

4. **Control Fascia Panel - Slave Module:** Remove 2 screws securing the outer fascia panel. Lift and remove fascia, store safely.



5. Remove 2 screws securing inner fascia panel. Lift and support panel while releasing ribbon cable from the display board. Remove fascia and store safely.



6. Remove and discard fascia retaining bracket (x 4) from Slave and Master modules.

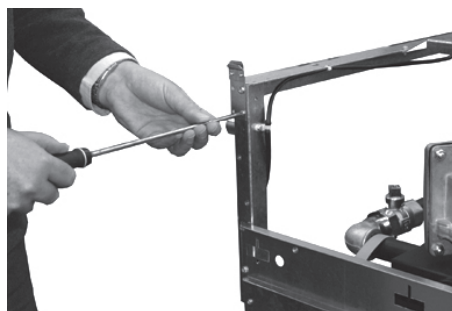

# INSTALLATION

## 10 ASSEMBLING THE MODULES .... CONTINUED

7. Position Master Module and level feet using a 13mm spanner. Check module with spirit level.

**IMPORTANT. ENSURE MODULE IS LEVEL IN BOTH DIRECTIONS TO ENSURE SATISFACTORY ASSEMBLY.**

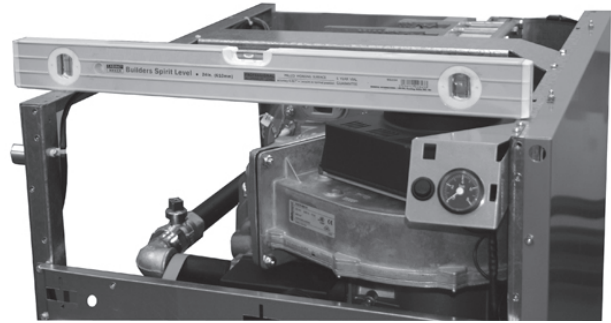

8. Position Slave Module to LH side of Master Module (ensuring not to disturb levelled Master Module) and repeat levelling process.



9. Remove 4 screws on each control box support channel and discard channels.

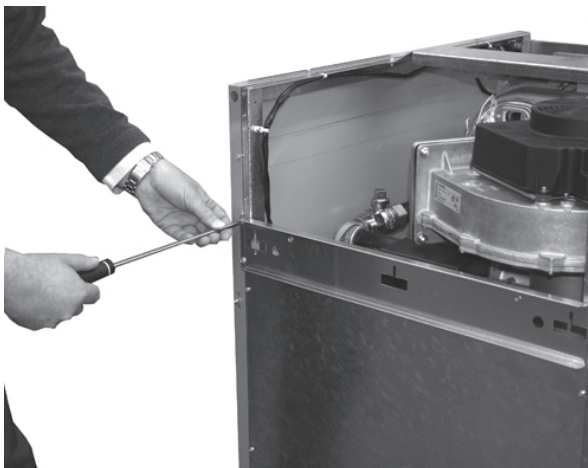

10. Replace with the one piece front controls channel and secure with 6 screws (located in casing assembly pack).

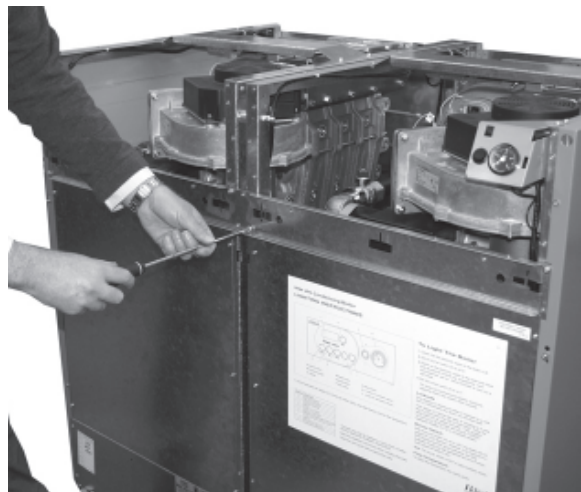

## 11 ASSEMBLING THE MODULES .... CONTINUED

11. Remove 4 screws on each rear gas pipe support channel and discard channels.

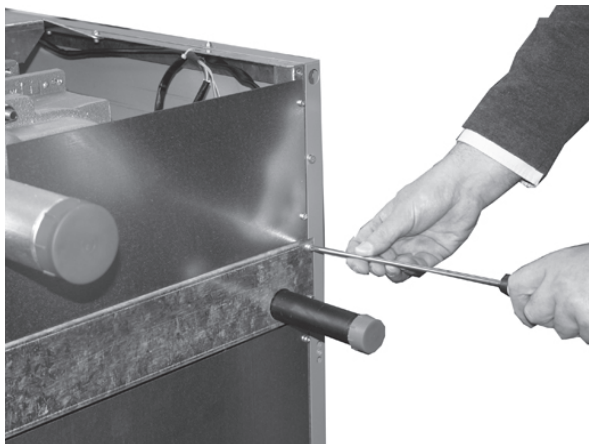

12. Replace with the one piece rear gas pipe support channel and secure with 6 screws (located in casing assembly pack).



13. Tie support the thermistor harnesses on each boiler module. The thermistor harness is located towards the rear of each boiler module. Using the 4 tie wraps supplied in the casing assembly pack, tie the harnesses to the 4 holes located on the inside face of the rear support channel.

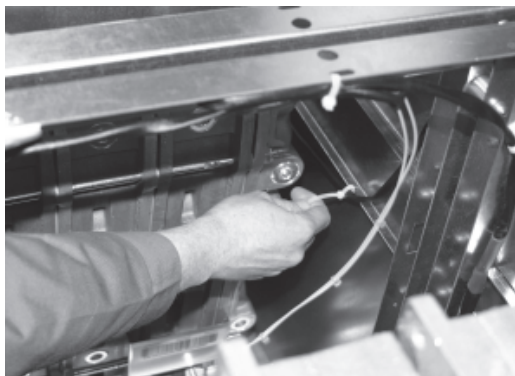

14. Place top panel onto both modules and secure at rear with 2 x M5 screws (supplied).

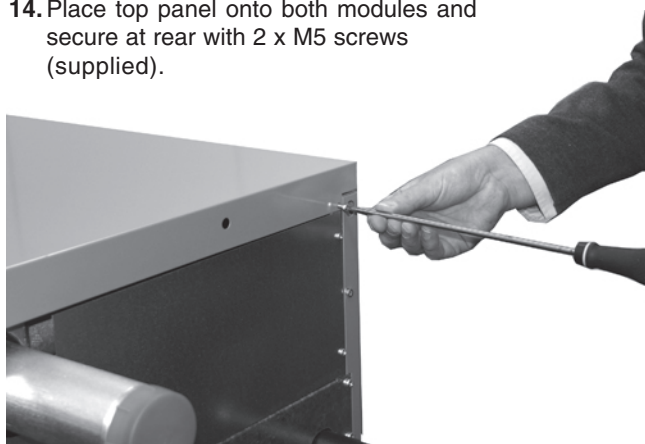

15. Fit master fascia panel securing with 2 x M4 screws. Ensure ribbon cable is re-fitted.



16. Fit Slave inner fascia panel to Slave Module securing with 2 x M5 screws whilst re-fitting ribbon cable to display board.



# INSTALLATION

## 12 FLUE / AIR DUCT INSTALLATION

See Table on page 5 for guidance on maximum permissible flue and air duct system design.

### FLUE

Construct either the horizontal or vertical combined flue outlet ductwork to create the manifold arrangement depicted. The horizontal combined flue outlet can be installed with its outlet facing left or right dependent upon the demands of each particular installation.

A tube of ductwork seal lubricant is provided within the flue kit. To ease flue connections lubricate all flue seals before assembly. Flue sampling points are fitted within the ductwork legs A and B as depicted to facilitate flue products sampling of each boiler module.

### IMPORTANT NOTES.

1. The flue manifold should be supported in such a way as not to place load on the boiler module flue outlet sockets. Propriety flue duct brackets must be used to provide support as appropriate.
2. Unless the connecting flue is manufactured from aluminium the condensate generated within the flue must be collected and drained before entering the combined flue outlet ductwork. When employing the vertical combined flue outlet header, a flue condensate drain is provided for this purpose.

### HORIZONTAL FLUE HEADER ARRANGEMENT

KEY	
A	Flue Tube
B	Flue Tube
C	Bend x 87°
D	Bend x 45°
E	Connector
F	Adaptor

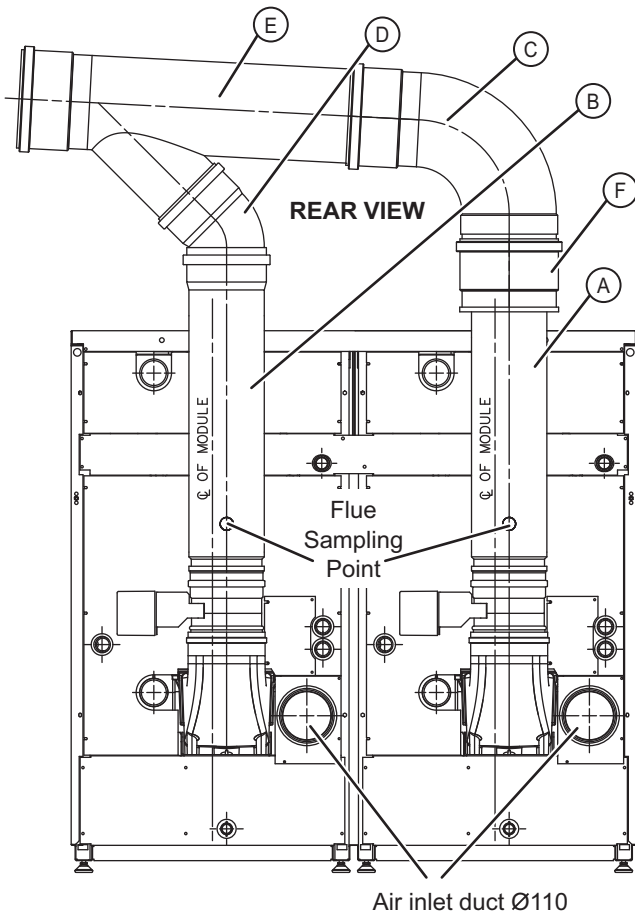

### VERTICAL FLUE HEADER ARRANGEMENT

KEY	
A	Flue Tube
B	Flue Tube
C	Flue Tee Manifold
D	Flue Condensate Drain Trap

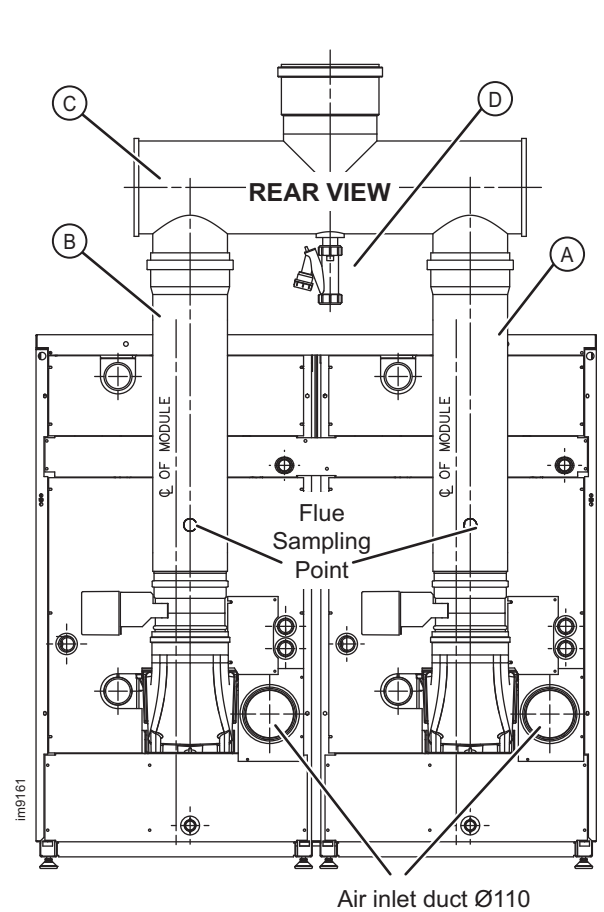

### AIR DUCT

Combustion air can be drawn directly from the boiler room using the high level air inlet kit provided or ducted in from outside the building in which the boiler is installed.

**IMPORTANT NOTE.** If combustion air is drawn from within the boiler room, ensure no dust or airborne debris can be ingested into the appliance. Dusty concrete flooring should be sealed to reduce the presence of dust. Ideally where possible duct the air supply into the boiler room from a clean source outside the boiler room / building.

To draw air direct from outside, connection can be made using separate ducts to each boiler Module. This can be done using any propriety 110mm soil / drain pipe. Expansion to a larger diameter may be required to reduce resistance, dependant on total flue / air duct lengths required. (See Flue System Design on Page 5). The air duct should be terminated with a suitable fixed grille to prevent entry to vermin. This terminal should be positioned as such to avoid blockages or entry of water.

An optional RS duct connector kit allows for the two individual module air inlet connections to be combined into a single 200mm boiler air supply connection to simplify installation and increase permissible air duct length (F320 and F400 only)

## 12 AIR DUCT CONT'D....

Where ducting the air from outside is not practical it can be drawn from the boiler room by assembling the air inlet pipework as follows into the configuration shown in fig 1 & 2.

1. Fit the 93° elbow into the boiler air inlet pipe.
2. Fit the 112.5° bend into the 93° elbow.
3. Fit the 110 dia. tube into the 112.5° bend.
4. Fit the air inlet grille to 110 dia. tube and fix with the 3 off self tapping screws provided.
5. Using the existing screws holding the upper or centre back panel to the boiler, fit the support bracket assembly and re-tighten the screws.
6. With the air inlet pipe assembly in position, retain it with the pipe clamp, fixed with the 2 off M5 screws provided.

With this kit fitted the maximum straight flue length available and maximum pressure available at the base of the flue to overcome flue resistance will change, refer to the appropriate table on page 5.

fig 1

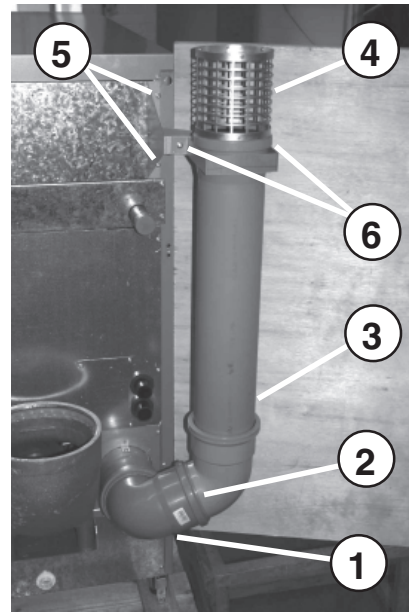
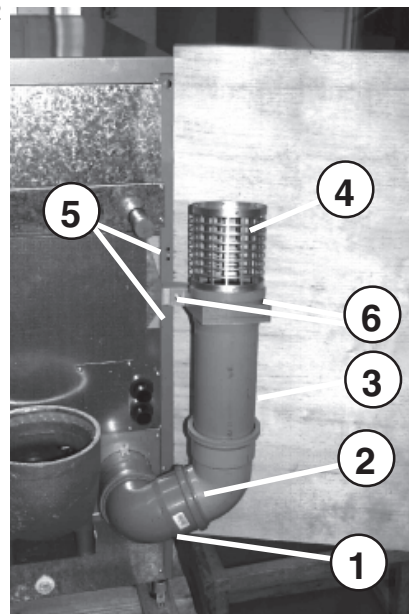

fig 2



## INSTALLATION

### 13 CONDENSATE DRAIN (Slave and Master)

A condensate drain must be connected to the condensate bulk head connector on the back of each module and then connected to a drainage point, preferably within the building.

The pipe size from the condensate connector on the lower rear panel is 21.5mm.

The routing of the drain must be made to allow a minimum fall of 1 in 20 away from the boiler, throughout its length.

If the vertical flue header is specified the flue manifold condensate drain connection must also be connected in the same manner.

**IMPORTANT.** Any external runs must be kept to a minimum and insulated. This is to avoid freezing in cold weather causing blocking.

All pipework and fittings in the condensate drain system must be made of plastic. No other materials may be used.

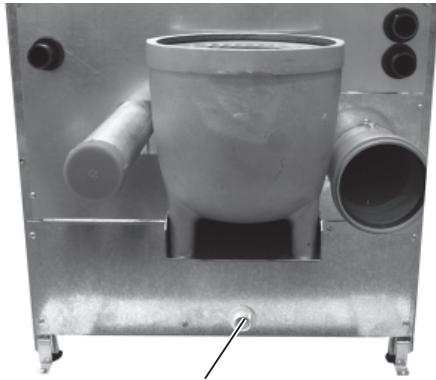

Condensate Bulkhead Connector

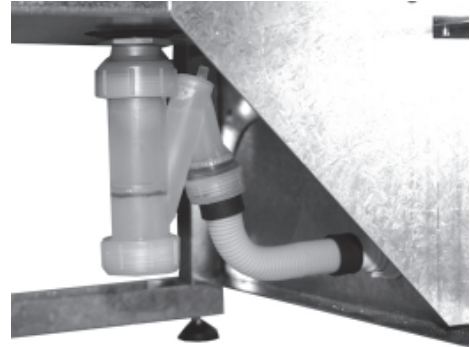

### 14 BOILER WATER CONNECTIONS

The boiler flow and return pipes are terminated with 2 x R2" BSP male connections at the rear of the appliance. Water returning from the system should be connected to a lower header pipe, with the flow water connection coming from a top header pipe. An optional pre-fabricated header pipe kit is available.

Refer to Frames 1 and 2 for dimensional positions.

All flow and return pipework must be independently supported.

Plastic plugs fitted on the open ends of the flow and return pipes must be removed before connecting the system pipework.

An air vent must be provided immediately after the flow connection.

If installing the boiler onto an existing system it is strongly recommended that the system be thoroughly flushed before connecting the boiler. When connecting to a new system it is still important to flush the whole system in accordance with the relevant standards.

**Note.**

*Connection to the boilers using manifolds must use a reverse return principle to ensure equal flow distribution through both of the modules, see example below.*

*Connection of opposing flow and return points can be made either on the LH side or RH side, dependent upon the particular needs of the boiler installation.*

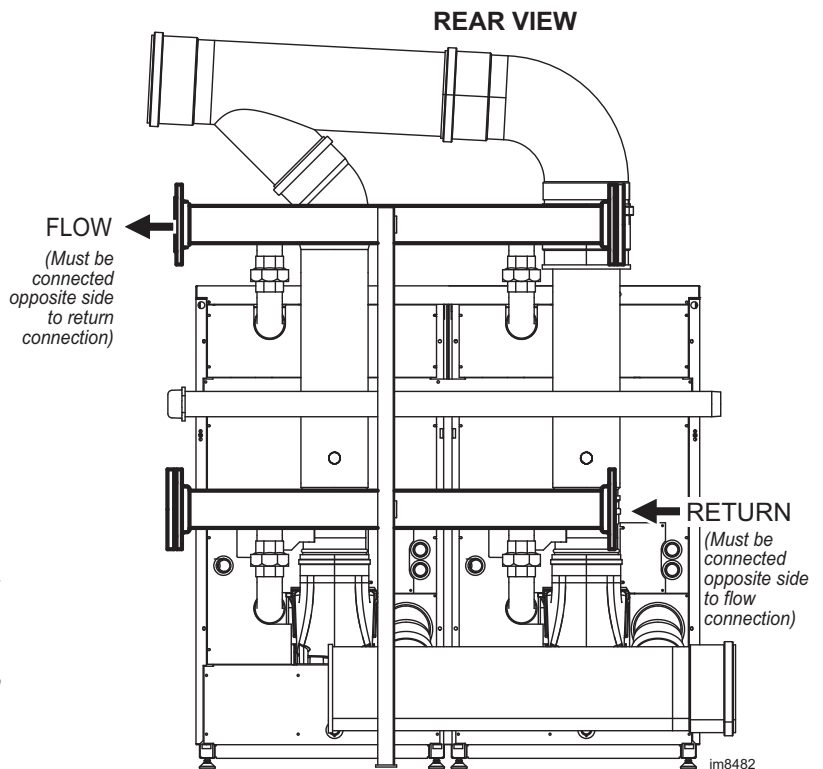

## 15 FROST PROTECTION

The boiler has built into its control system the facility to protect the boiler only against freezing.

If the boiler flow temperature  $T_1$ , falls below 7°C the pump will be activated without the boiler firing.

If the flow temperature falls below 5°C the boiler will fire until the flow temperature exceeds 10°C. The pump will stay running for a further 5 minutes.

Central heating systems fitted wholly inside the building do not normally require frost protection as the building acts as a 'storage heater' and can normally be left at least 24 hours without frost damage. However, if parts of the pipework run outside the building or if the boiler will be left off for more than a day or so, then frost protection for the system is recommended.

## 16 GAS CONNECTIONS

The boiler gas supply pipe is terminated in 2 x R1" BSP male taper connections on the left-hand sides of the modules.

A gas header kit is available to combine the inlet connections to a 2" manifold.

All gas supply pipework must be independently supported. A minimum working gas pressure of 15mbar (6" w.g.) must be available at the boiler inlet with the boiler firing. Fit a gas supply pipe NOT LESS THAN 2" BSP to the boiler.

## 17 ELECTRICAL CONNECTIONS

**Warning.** This appliance MUST be efficiently earthed.

A mains supply of 230V 50Hz is required to be fitted to both the Master and Slave Modules (see terminals marked 'Mains In' Frame 19). External controls should NOT be wired in series with these mains inputs. Controlling the boiler in this way will prevent the pump over-run sequence and may cause damage to the modules. The supply wiring MUST be suitable for mains voltage. Wiring should be 3 core PVC insulated cable NOT LESS than 0.75mm<sup>2</sup> (24 x 0.2 mm) and to BS. 6500, Table 16. The fuse rating should be 7A.

Wiring external to the boiler MUST be in accordance with the current I.E.E. (BS7671) wiring Regulations and any local regulations. For Ireland reference should be made to the current ETCI rules for electrical installations.

Connection should be made in a way that allows complete isolation of the electrical supply - such as a double pole switch, having a 3mm (1/8") contact separation in both poles, or a plug and unswitched socket serving only the boiler and system controls. The means of isolation must be accessible to the user after installation.

When making mains electrical connections to the modules it is important that the wires are prepared in such a way that the earth conductor is longer than the current carrying conductors, such that if the cord anchorage should slip the current carrying conductors become taut before the earthing conductor.

**WARNING. Sensor cables must be separated from cables in the 230V circuit. For this purpose three conduits are provided. Refer to Frame 19 for terminal strip connections.**

## 18 INSTALLING THE MAINS AND CONTROL WIRING (MASTER AND SLAVE MODULES)

1. Route all 230V circuits in at the rear, through conduit no. 1 on both Master and Slave Modules.
2. Route all low voltage remote sensor/control cables for the master module through conduit no. 2.
3. Secure the cables with the cable clamps provided on the main controls panel.

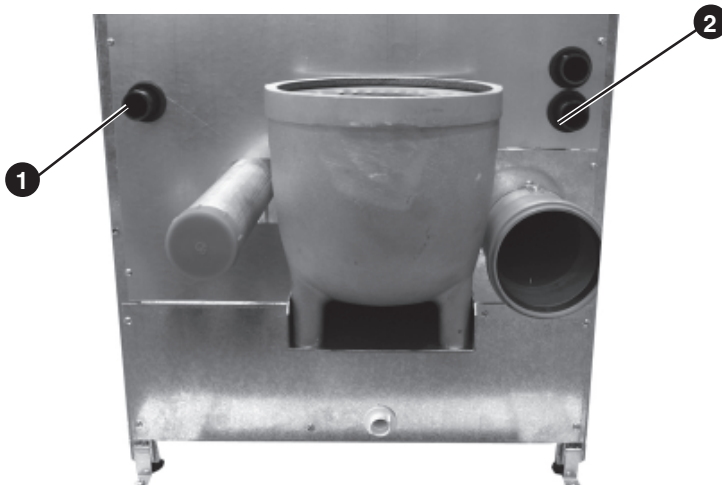

# INSTALLATION

## 19 INSTALLER CONNECTIONS

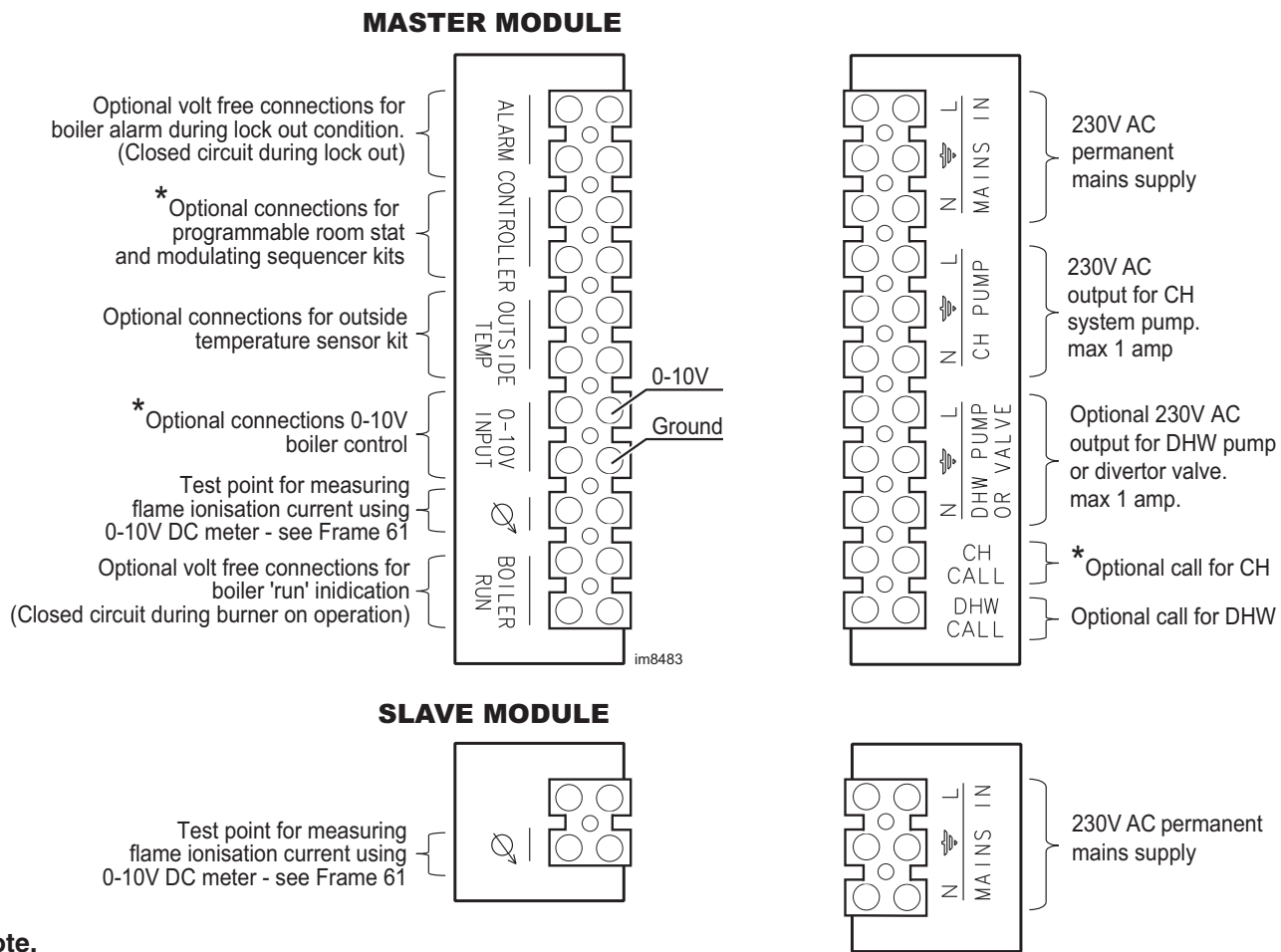

**\* Note.**

**BOTH OT CENTERS MUST BE CONFIGURED IN ACCORDANCE WITH BOILER CONTROL INPUT OPTION CHOSEN.**  
(See Frame 22 for details)

## 20 CH CONTROL CONNECTIONS

Input terminals are available for connecting a variety of system controls for central heating demand. Only one method should be employed on an individual boiler. OT Centers to be configured in accordance with choice mode (see to Frame 22).

Heating demand can be controlled by:

- 1. ON/OFF using a 230V switched live to 'CH call' terminal. (e.g. programmer and/or room thermostat).**  
A call for heat will cause the boiler to run and maintain a set flow temperature controlled by parameter 4\* (see Frame 31).  
Connect switched live to Master Module terminal marked 'CH CALL'.
- 2. Programmable Room Thermostat Kit.**  
The programmable room thermostat kit incorporates a room temperature sensor and a programmer capable of controlling the heat output from the boiler to satisfy different temperature requirements at different time periods. The addition of an Outside Sensor Kit will enable a weather compensated flow temperature (see Instructions with kit for more details).  
Connect Programmable Room Thermostat to Master Module using terminals marked 'CONTROLLER'. Wires have no polarity and are low voltage control cables.

**3. Modulating Sequencer Kit.**

A Modulating Sequencer Kit is capable of controlling the heat demand on up to 5 boilers simultaneously. (See instructions with kit for more details.)

Connect Modulating Sequencer Kit to Master Module using terminals marked 'CONTROLLER'. Wires have no polarity and are low voltage control cables.

**4. 0-10V**

A call for heat can be generated using a 0-10V input with the flow temperature setpoint controlled by the voltage signal. 10V generates a maximum flow temperature top limited by parameter 4\* (see Frame 31).

Connect 0-10V signal to Master Module using terminals marked '0-10V INPUT'. The ground wire should be connected to the lower terminal and the 0-10V modulating signal to the upper terminal.

**CH Pump**

Output terminals marked 'CH PUMP' are provided for a circulating pump which must be connected to allow the pump overrun function to operate. A pump requiring more than 1 amp supply current must be connected via a relay.

\* Changes to parameter 4 must be carried out in common to both Master and Slave Modules.

# INSTALLATION

## 21 DHW CONTROLS CONNECTIONS

If the boiler is providing both CH and DHW, and the CH circuit is to operate for periods at a reduced temperature (i.e. weather compensated), then it is necessary to differentiate between CH and DHW heat demands. For this purpose a DHW demand can be placed on the boiler using the method shown below.

A demand for DHW has priority over CH by parameter 43 (see Frame 38).

A call for DHW will cause the boiler to run and maintain a set flow temperature of 80°C.

DHW heat demand can be controlled by:

- ON/OFF using a 230V switched to live 'DHW call' terminal (e.g. a cylinder thermostat and/ or programmer).**

A call for heat will cause the boiler to run and maintain a set flow temperature of 80°C.

Output terminals are provided for a DHW pump or valve. This output can be used to control the diversion of flow to the DHW circuit. A pump or valve requiring more than 1 amp supply current must be connected via a relay.

*\* Changes to parameter 4 must be carried out in common to both Master and Slave Modules.*

## 22 OT CENTER CONFIGURATION

The OT Centers on each module are factory pre-set as master and slave units for CH ON/OFF call for heat.

To check the settings or to configure for alternative control options remove the OT Center and set switches "S1 and "S2" according to the tables below (See Frame 67 for details of how to remove and replace OT Centers).

Position S2	Function
1	Master - Module
2	Slave Module

Position S1	Function
1	N/A
2	N/A
3	OpenTherm programmable room stat or sequencer kit
4	CH ON-OFF call for heat
5	0 to 10 V Input

### Note.

*Both OT Centers (Master and Slave Modules) must be configured similarly.*

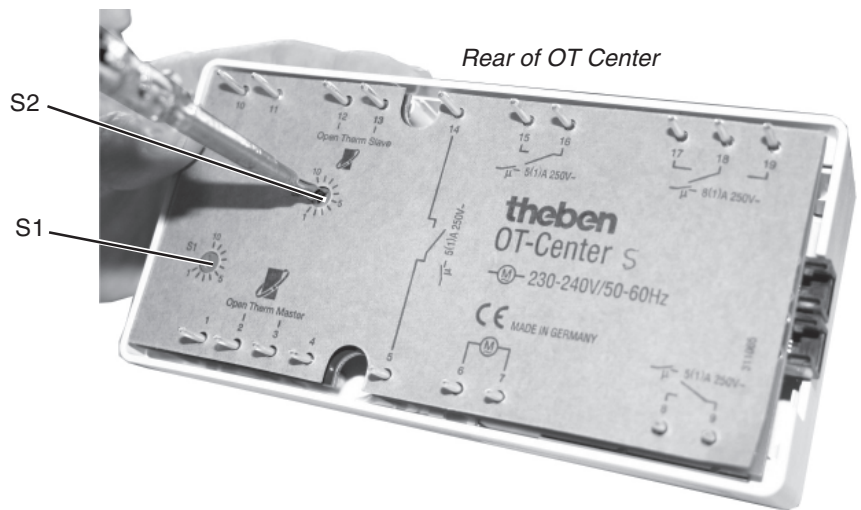

## 23 FITTING OT CENTER

- Locate the communication lead attached to the OT Center on the Master Module.
- Route cable through grommet, and across behind control panels and back out through grommet.
- Plug remaining end into either socket on Slave Module OT Center.

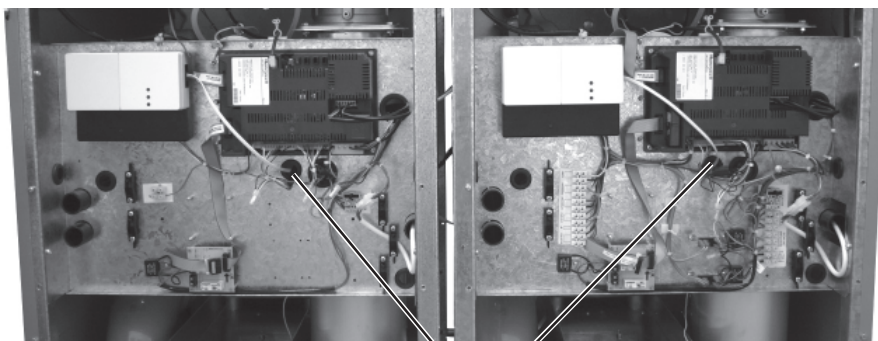

# INSTALLATION

## 24 PICTORIAL WIRING DIAGRAM (MASTER BOILER)

INSTALLATION

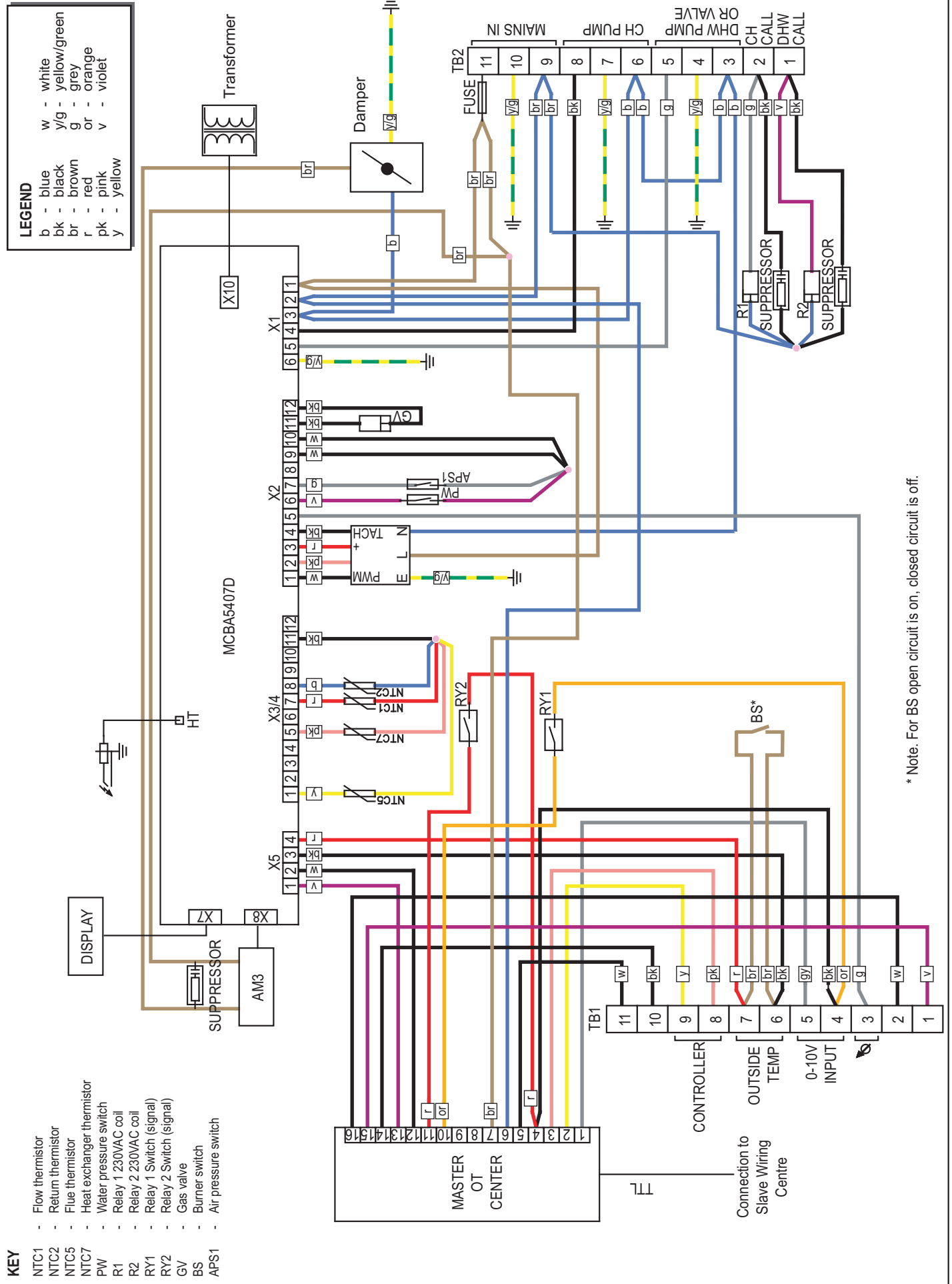

\* Note. For BS open circuit is on, closed circuit is off.

# INSTALLATION

## 25 PICTORIAL WIRING DIAGRAM (SLAVE BOILER)

LEGEND	
w	- white
b	- blue
bk	- black
br	- brown
r	- red
pk	- pink
y	- yellow
y/g	- yellow/green
g	- grey
or	- orange
v	- violet

- KEY**
- Flow thermistor
  - Return thermistor
  - Flue thermistor
  - Heat exchanger thermistor
  - Water pressure switch
  - Relay 1 230VAC coil
  - Relay 2 230VAC coil
  - Relay 1 Switch (signal)
  - Relay 2 Switch (signal)
  - Gas valve
  - Burner switch
  - Air pressure switch

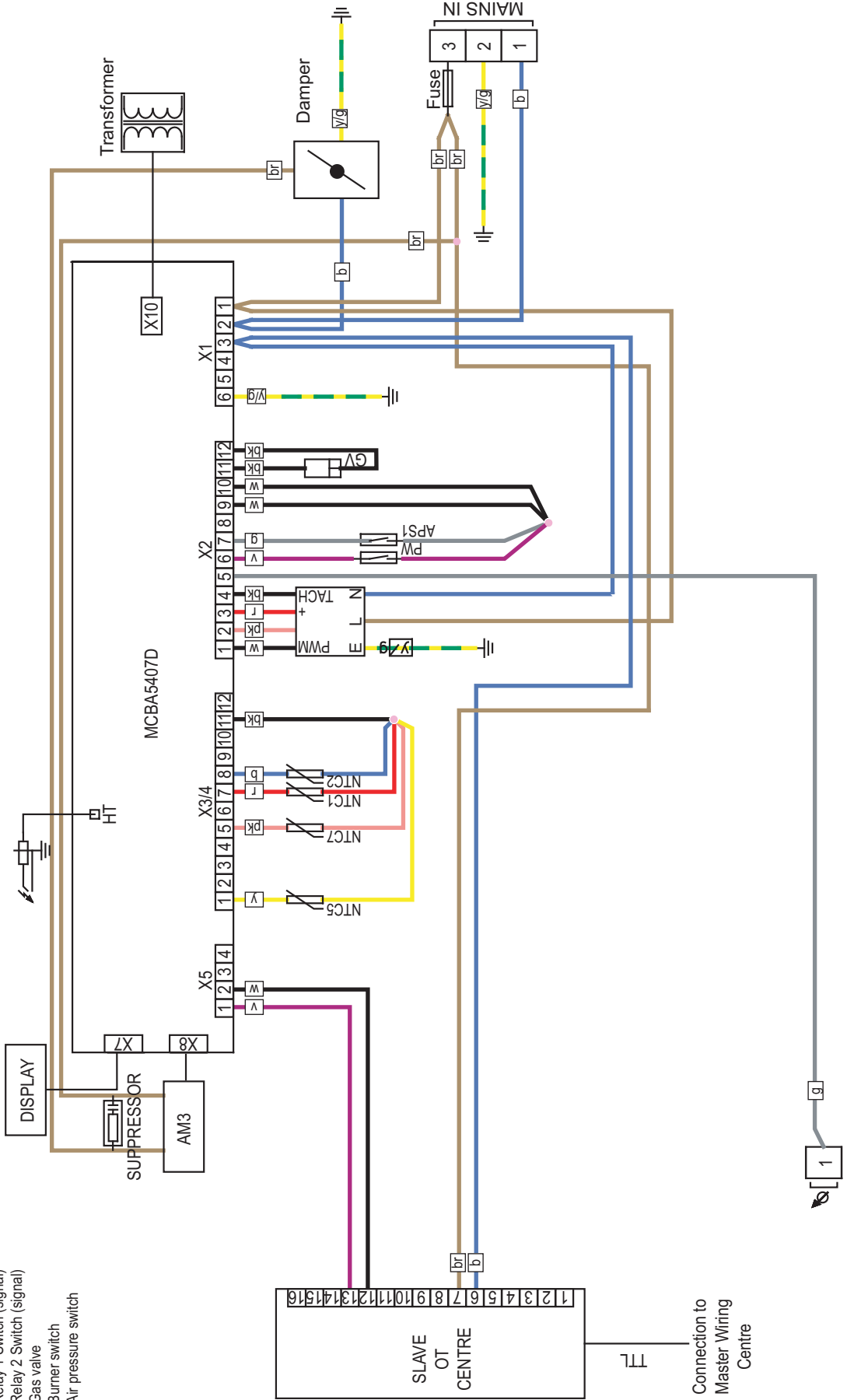

# INSTALLATION

INSTALLATION

## 26 CH ON/OFF NO SEPARATE DHW DEMAND

For simple ON/OFF control of the boiler with a fixed flow temperature setpoint (see parameter 4 Frame 31), then the following method should be used for connecting the boiler.

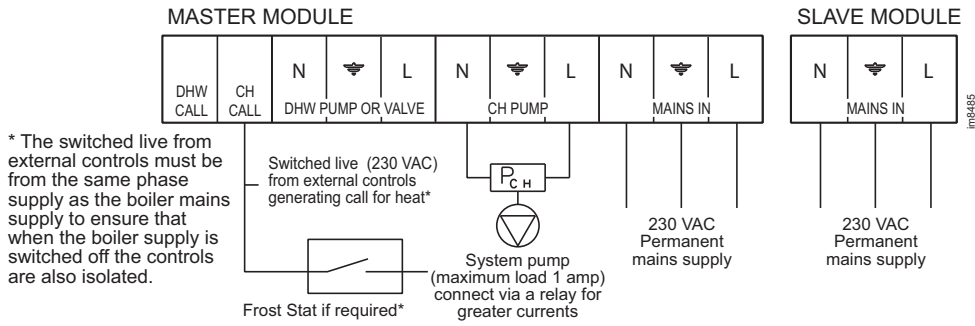

**No parameter modifications are required.**

## 27 MAINS VOLTAGE CH AND DHW CONTROLS WITH DHW PUMP OUTPUT

This system provides heating to one zone at a time with DHW priority controlled by parameter 43. To heat more than one zone simultaneously, use zone thermostats to energise individual zone valves with all calls for heat applied to 'CH CALL'. The boiler will be limited to responding with a set flow temperature set by parameter 4 (see Frame 31).

If all zones are fitted with individual zone valves a hydraulic bypass will be required to allow pump overrun. See pages 6 and 10 for details.

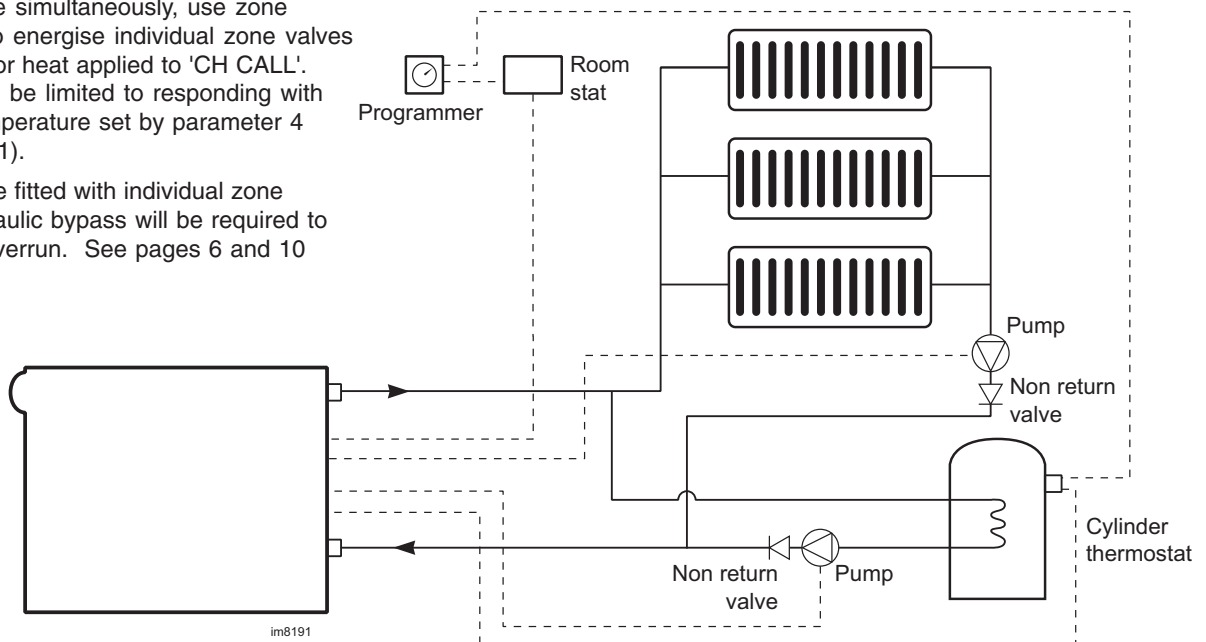

**No parameter modifications are required.**

**Alternatives:** The Ideal programmable room thermostat and outside sensor kit provides enhanced user comfort. Full instructions provided with kits.

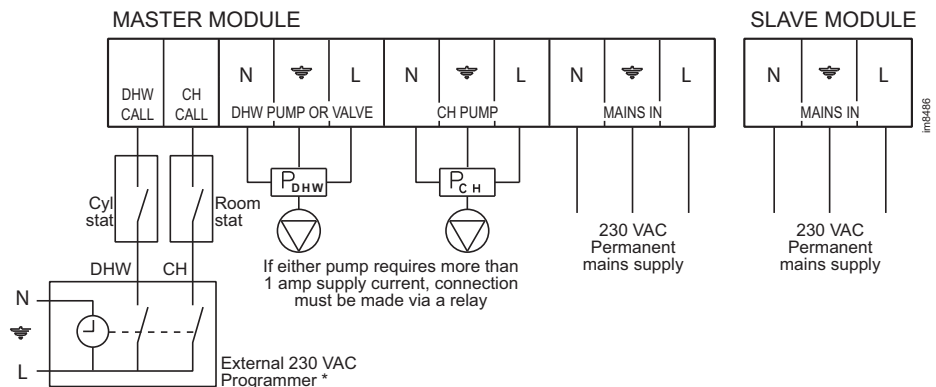

\* The switched live from external controls must be from the same phase supply as the boiler mains supply to ensure that when the boiler supply is switched off the controls are also isolated.

# INSTALLATION

## 28 MAINS VOLTAGE CH AND DHW CONTROLS WITH DHW VALVE OUTPUT

This system provides heating to one zone at a time with DHW priority controlled by parameter 43. To heat more than one zone simultaneously, use zone thermostats to energise individual zone valves with all calls for heat applied to 'CH CALL'. The boiler will be limited to responding with a set flow temperature set by parameter 4 (see Frame 31).

If all zones are fitted with individual zone valves a hydraulic bypass will be required to allow pump overrun. See page 6 and 10 for details.

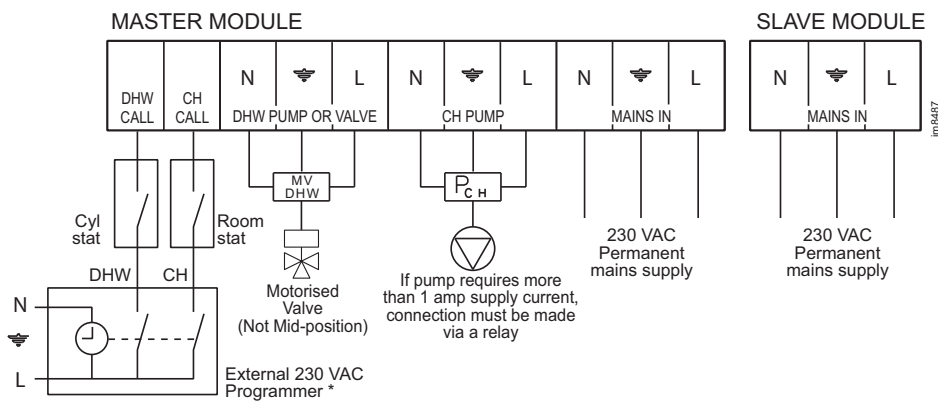
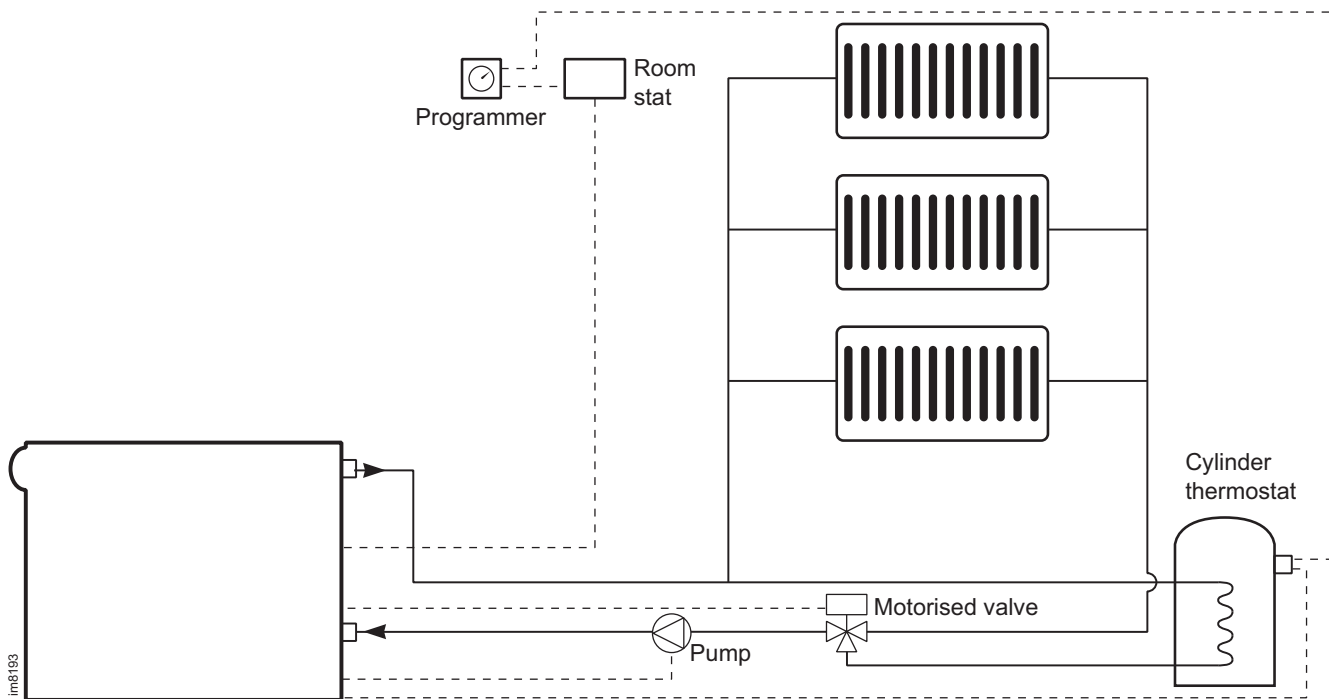

\* The switched live from external controls must be from the same phase supply as the boiler mains supply to ensure that when the boiler supply is switched off the controls are also isolated.

Parameter modifications see Frames 35 to 39.

Parameter 46 = 03 If a live output is required for positioning of the valve to satisfy CH demand.

Parameter 46 = 23 If a live output is required for positioning of the valve to satisfy DHW demand.

**Alternatives:** The Ideal programmable room thermostat and outside sensor kit provides enhanced user comfort. Full instructions provided with kits.

# INSTALLATION

## 29 EXAMPLES OF HEATING SYSTEMS

Heating system with DHW production (storage tank Output = Boiler Output) and mixing header.

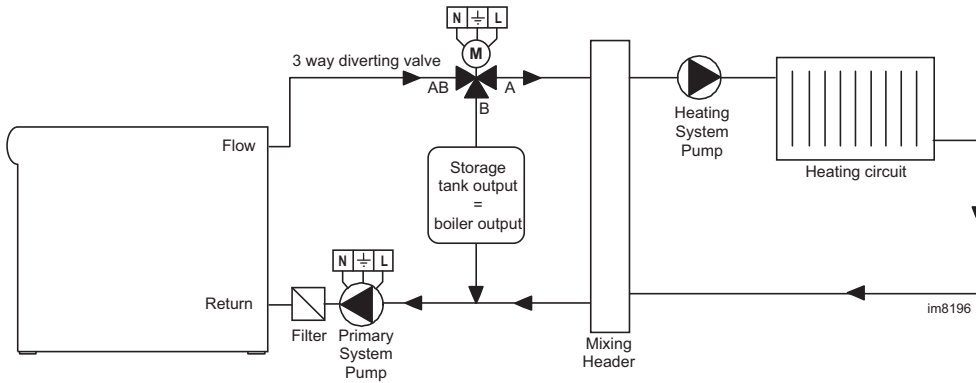

**Note.**

If PARA '46' 1st digit is set to 2, it means you wish to have a 3 way valve normally open towards the CH circuit (radiator circuits from AB to A). Upon DHW request, terminal 'L' on 'DHW PUMP OR VALVE' is energised which, through a relay, powers the 3-way valve, thus closing port A and opening port B. Simultaneously terminal 'L' on 'CH PUMP' is energised which, through another relay, powers the primary system pump.

If PARA '46' 1st digit is set to 0, it means you wish to have a 3 way valve normally open towards the storage tank (DHW circuit from AB to B). Upon CH request, terminal 'L' on 'DHW PUMP OR VALVE' is energised which, through a relay, powers the 3-way valve, thus closing port B and opening port A. Simultaneously terminal 'L' on 'CH PUMP' is energised which, through another relay, powers the primary system pump.

Heating system with one group of radiators (controlled by thermostatic valves)

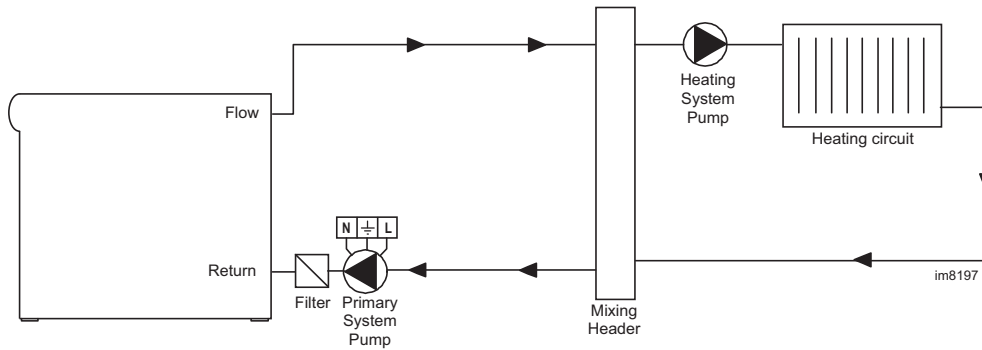

DHW storage tank with DHW pump installed on the secondary circuit, in parallel with the heating circuit

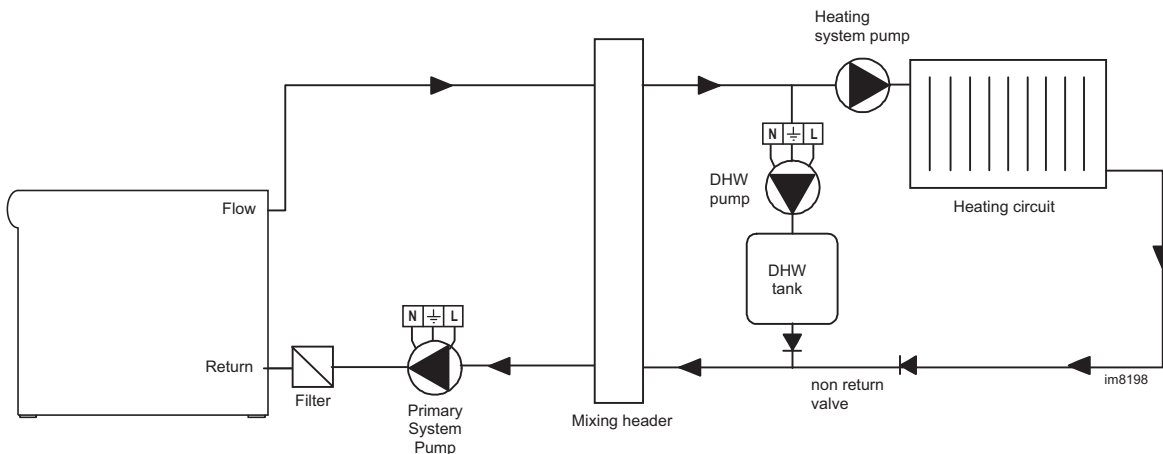

**Note.**

The primary system pump would be off while the DHW pump is running with PARA '46' 1st digit set to '1x'. This would only give adequate circulation if the DHW pump was connected into the primary circuit, shown to the left of the mixing header above. However, in the case shown it will be necessary to run the primary system pump with the DHW pump for correct circulation. To achieve this set PARA '46' 1st digit '2x'.

# INSTALLATION

## 30 BASIC CONTROLS DISPLAY (MASTER PANEL SHOWN)

Both Master and Slave Modules employ a control panel.

Slave control panel can be fully accessed by first removing cover (see Frame 52).

- A. Burner switch
- B. Pressure gauge
- C. Display
- D. Reset button
- E. Mode button
- F. Step button
- G. Store button
- H. + button (to increase values)
- I. - button (to decrease values)

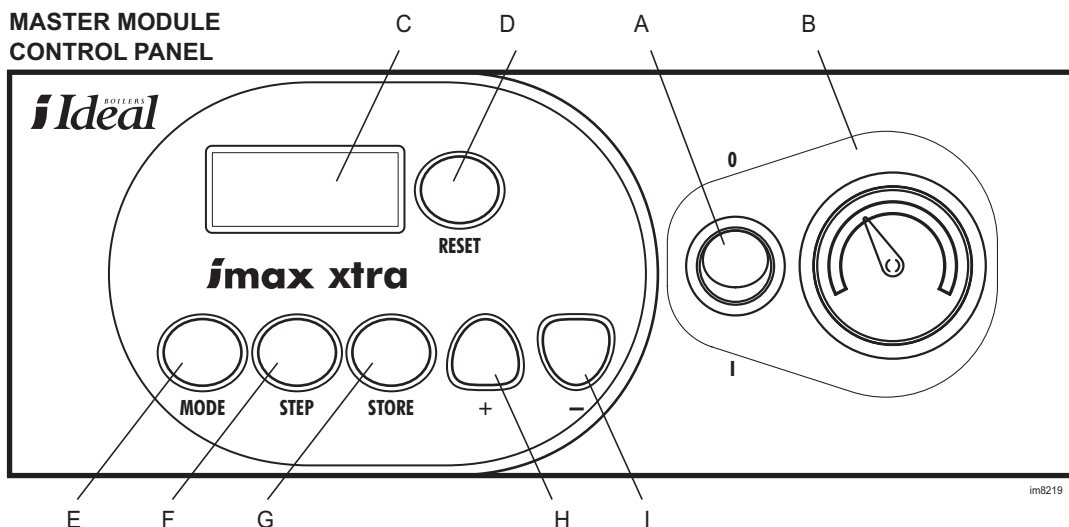

Sequence	Boiler Status
A	DHW valve energised
0	Standby, no heat request
1	Pre-purge, post purge
2	Ignition
3	Burner on in CH mode
4	Burner on in DHW mode
5	Waiting for air pressure switch to open or close
6	Burner off because a set value has been reached
7	Pump overrun in CH mode
8	Pump overrun in DHW mode

During the operation of the **iMax xtra**, the status of the appliance can be determined by the display.

### 1. Normal Operation Mode

The unit will either be in standby or in operation. The first digit on the display shows the boiler status (see table). The last 3 digits show the flow temperature.

### 2. Blocking Mode

The Module will enter blocking mode under certain fault conditions. Whilst in blocking mode the burner is switched off. Once the fault conditions are clear the boiler will automatically reset itself. In blocking mode the display will alternate between showing a '9' in digit one, along with the flow temperature in digits 2, 3 and 4.

e.g. 9 9 6

Followed by the blocking code 'bxx'. Refer to page 54 for Blocking Code references.

b 1 8

### 3. Error Mode

In error mode the display will show the error code.

E 3 6

Refer to Page 52 for error codes.

The Module will enter error mode under certain fault conditions. The unit will be inoperative until the fault is rectified. The reset button is used to reset the Module control box after an error has occurred.

### Self Check and Anti-seize Modes

After switching on the mains power or after a reset, the boiler performs a selfcheck, i.e. the DHW valve is energised and the CH pump is switched on for 10 seconds. This cycle repeats itself every 24hrs, as long as no heat request is given in 24hrs.

### Burner on/off switch

With the burner switch set to 'off' the boiler will not respond to a CH demand. However, it will respond to a DHW demand and the pump anti-seize and frost protection modes are still operational any one of which could cause the boiler to fire. Note. The burner switch is NOT a mains isolation switch.

### CH/DHW Systems

In standby mode pressing and holding the '+' button for 3 seconds turns the CH system on/off.

In standby mode pressing and holding the '-' button for 3 seconds turns the DHW system on/off.

## 31 STANDARD CONTROLS ACCESS

### Modes of Operation

The standby, parameter and information modes are accessible without the service code.

#### Standby Mode

Stby

The standby mode will be shown after start up or reset of the Module control box. If no buttons are pressed for 20 minutes the display will automatically be set to standby mode. If new parameters have been stored they will then become active.

#### Parameter Mode

PARA

In parameter mode it is possible to change the settings of the Module control box. The following settings can be changed.

**NOTE. Changes to these parameters MUST be done in common to both Master and Slave Modules.**

1.	DHW Temperature (T3)
2.	DHW System ON/OFF
3.	CH System ON/OFF
4.	Flow Temperature (T1)





Parameter settings and limits are listed below.

Parameter mode is entered from standby mode by pressing the 'mode' button once.

Press	Display
	<span style="border: 1px solid black; padding: 2px;">PARA</span>

Press the 'step' button until the desired parameter is displayed.

The dot after the 1st digit is illuminated to indicate that the boiler is in 'PARA' mode.

Press	Display	Description	Lower Limit	Upper Limit	Factory Setting
	<span style="border: 1px solid black; padding: 2px;">1. 6 0</span>	NA	Do not adjust	Do not adjust	60
	<span style="border: 1px solid black; padding: 2px;">2. 0 1</span>	<b>DHW System</b> 00 = Off 01 = On 02 = Off + pump continuous 03 = On + pump continuous			01
	<span style="border: 1px solid black; padding: 2px;">3. 0 1</span>	<b>CH System</b> 00 = Off 01 = On 02 = Off + pump continuous 03 = On + pump continuous			01
	<span style="border: 1px solid black; padding: 2px;">4. 8 2</span>	<b>CH Flow Temperature (°C) (T1)</b>	20	90	82

Press the '+' or '-' buttons to change the values.

The parameter setting can be stored by pressing and releasing the 'store' button, the new setting flashes twice to show it has been accepted. The new setting will become active when the parameter mode is left.



*continued.....*

## 32 STANDARD CONTROLS ACCESS CONT'D











### Info Mode

**INFO**

Info mode is entered from standby mode by pressing the 'mode' button twice.

Press	Display
	<b>PARA</b>
	<b>INFO</b>

Press the step button until the desired information is displayed. The dot after the 1st digit will be flashing indicating the Module is in 'info' mode. No settings can be changed in 'info' mode.



Press	Display	Description
	Flashing <b>1. 2 1</b>	Actual Flow Temperature T1 (°C)
	<b>2. 2 1</b>	Actual Return Temperature T2 (°C)
	<b>3. - 3 6</b>	NA
	<b>4. - 3 6</b>	OUTSIDE Temperature T4 (°C) (-36 displayed if outside sensor kit not fitted)
	<b>5. 7 0</b>	FLUE GAS Temperature T5 (°C)
	<b>6. 8 2</b>	Set Flow Temperature (°C)
	<b>7. 0.0</b>	Rate of Flow Temperature Rise (°C/s)
	<b>8. 0.0</b>	Rate of Return Temperature Rise (°C/s)
	<b>9. 0.0</b>	NA
	<b>A. - 3 6</b>	NA

*continued.....*

# INSTALLATION

## 33 STANDARD CONTROLS ACCESS CONT'D



Info mode cont'd.....

Press	Display	Description
	<b>b.</b> 0.0	N/A
	<b>C.</b> 82	Heat Exchanger Temperature T7 (°C)
	<b>d.</b> 0.1	Rate of increase in Temperature T7 (°C/s)
	<b>E.</b> 0.1	Ionisation Current (micro amps)
	<b>F.</b> 0.0	N/A
	<b>G.</b> 0.0	N/A
	<b>H.</b> 35	Boiler Control Module Internal Temperature (°C)
	<b>I.</b> 00	Number of Ignitions, CH 100 thousands/10 thousands
	<b>i.</b> 00	Number of Ignitions, CH thousands/hundreds
	<b>i.</b> 00	Number of Ignitions, CH tens/units
	<b>J.</b> 00	Burner Run Hours, CH 100 thousands/10 thousands
	<b>i.</b> 00	Burner Run Hours, CH thousands/hundreds
	<b>i.</b> 00	Burner Run Hours, CH tens/units
	<b>L.</b> 00	Number of Ignitions, DHW 100 thousands/10 thousands
	<b>i.</b> 00	Number of Ignitions, DHW thousands/hundreds
	<b>i.</b> 00	Number of Ignitions, DHW tens/units

*continued.....*

## 34 STANDARD CONTROLS ACCESS CONT'D

Info mode cont'd.....

Press	Display	Description
	<b>N. 0 0</b>	Burner Run Hours, DHW 100 thousands/10 thousands
	<b>. 0 0</b>	Burner Run Hours, DHW thousands/hundreds
	<b>. 0 0</b>	Burner Run Hours, DHW tens/units

### Service Mode



**L 6 0**      or      **H 8 0**

It is possible for servicing purposes to run the boiler on maximum or minimum loads.

This mode is entered from normal operating mode.



Press	Display	Description
	<b>X X X X</b>	As found
 several times	<b>S t b y</b>	Standby display
Wait a few seconds	<b>0 2 8</b>	Normal Display

Press the 'mode' and '-' button simultaneously for 3 seconds.

Press	Display	Description
 	<b>L 6 0</b> *	'Min. Load'. Run for 15 mins

OR

Press the 'mode' and '+' button simultaneously for 3 seconds.

Press	Display	Description
 	<b>H 8 0</b> *	'Max. Load'. Run for 15 mins

\*Last 3 digits are actual flow temperature

This mode will end automatically after 15 minutes. Alternatively to escape sooner press the '+' and '-' simultaneously.

In order to set the Module to a fixed fan speed proceed to CODE MODE (Page 32) and select 'PARA' mode 47 (Page 28).

## 35 ADVANCED CONTROLS ACCESS

There is little requirement for advanced controls access as factory preset values are satisfactory for most parameters. If parameter changes are required with the optional kits then further instructions are provided with them.

This mode must only be entered by a competent engineer. This level of access **MUST NOT** be entered by the user.



### Code Mode

**CODE**

By entering the service code the following additional features are accessible:

- Parameters 5 to 53
- Fan Speed Mode
- Communication Mode
- Error Mode



Code Mode is entered from 'standby' mode by pressing and holding the 'mode' and 'step' buttons. When the display shows 'CODE' release the buttons.

Press	Display
 	<b>CODE</b>

Press the 'step' button once and the display will show 'C' as the first digit and a random number in the 3rd and 4th digits.

Press	Display
	<b>C X X</b>

Use the '+' or '-' button to change the Code to 54.

Press	Display
 <span style="margin: 0 10px;">or</span> 	<b>C 5 4</b>

Press and release the 'store' button, the display flashes to show the code has been accepted.















Press	Display
	<b>C 5 4</b> <small>FLASHING</small>

Press the 'mode' button until the mode you want is displayed.

*continued.....*

# INSTALLATION











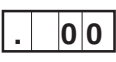

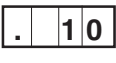

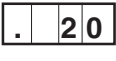



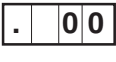

## 36 ADVANCED CONTROLS ACCESS CONT'D

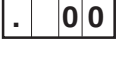
	Press	Display	Description	Lower Limit	Upper Limit	Factory Setting
		<b>PARA</b>				
1		<b>1. 60</b>	N/A	Do not adjust	Do not adjust	60
2		<b>2. 01</b>	<b>DHW System</b> 00 = Off 01 = On 02 = Off + pump continuous 03 = On + pump continuous			01
3		<b>3. 01</b>	<b>CH System</b> 00 = Off 01 = On 02 = Off + pump continuous 03 = On + pump continuous			01
4		<b>4. 82</b>	<b>CH flow temperature (°C) T1 (max.)</b>	20	90	82
Steps 5 to 9 are not accessible.						
10		P10 appears for 1 second then <b>. 20</b>	<b>CH flow temperature (min) (°C)</b> Lowest set flow temperature on the warmest day (para 12)	15	60	25
11		P11 <b>. -05</b>	<b>Minimum outside temperature (°C)</b> Coldest outside temp. the system is designed to work against	-20	10	-05
12		P12 <b>. 20</b>	<b>Maximum outside temperature (°C)</b> Warmest outside temp. the system is designed to work against	15	25	20
13		P13 <b>. -02</b>	<b>Outside temperature (°C)</b> (at which frost protection starts)	-30	10	-02
14		P14 <b>. 00</b>	<b>Outside temperature correction (°C)</b> (for boiler reading of outside temperature)	-05	05	00
15		P15 <b>. 80</b>	N/A	20	45	40
16		P16 <b>. 25</b>	N/A	10	40	20
17		P17 <b>. 10</b>	N/A	01	30	03
18		P18 <b>. 25</b>	<b>Blocking CH flow temperature (°C)</b> Boiler will not fire if the CH flow temperature set point is less than this note 00 = Off	Do not adjust	Do not adjust	25

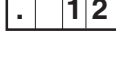
*continued.....*

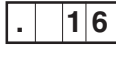
# INSTALLATION



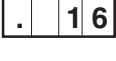









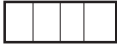

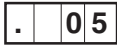

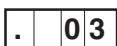

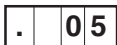

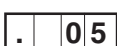

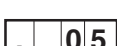

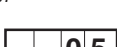

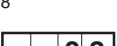

## 37 ADVANCED CONTROLS ACCESS CONT'D

	Press	Display	Description	Lower Limit	Upper Limit	Factory Setting
19		P19 	<b>Booster time (minutes)</b> note 00 = Off	00	30	00
20		P20 	<b>CH flow parallel shift</b> For use with outside temperature sensor	00	80	10
21		P21 	NA	Do not adjust	Do not adjust	20
22		P22 	<b>Maximum fan speed CH (hundreds)</b>	F320 F400 F480 F560	Do not adjust	52 52 55 55
23		P23 	<b>Maximum fan speed CH (units)</b>	F320 F400 F480 F560	Do not adjust	00 00 00 00
24		P24 	<b>Maximum fan speed DHW (hundreds)</b>	F320 F400 F480 F560	Do not adjust	52 52 55 55
25		P25 	<b>Maximum fan speed DHW (units)</b>	F320 F400 F480 F560	Do not adjust	00 00 00 00
26		P26 	<b>Minimum fan speed (hundreds)</b>	F320 F400 F480 F560	Do not adjust	18 20 19 17
27		P27 	<b>Minimum fan speed (units)</b>	F320 F400 F480 F560	Do not adjust	00 00 00 00
28		P28 	<b>Ignition fan speed (hundreds)</b>	F320 F400 F480 F560	Do not adjust	35 25 25 25
29		P29 	<b>Fan speed during forced low time (x100rpm)</b>	F320 F400 F480 F560	Do not adjust	20 20 20 20

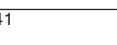
*continued.....*

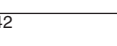
# INSTALLATION

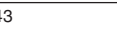

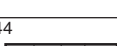



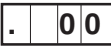

## 38 ADVANCED CONTROLS ACCESS CONT'D

	Press	Display	Description	Lower Limit	Upper Limit	Factory Setting
30		P30 	<b>Forced low time</b> (x 9 seconds)	Do not adjust	Do not adjust	6
31		P31 	TIME - Temp. differential between flow temp & set point at which slow start ends.	0	15	10
			TIME - Modulation rate in slow start X 400rpm/min	0	15	02
32		P32 	<b>CH post pump time</b> (minutes) Note 0 = 10 seconds Do not set below 05	00	99	05
33		P33 	<b>DHW post pump time</b> (x 10 seconds)	00	30	11
34		P34 	<b>CH modulation hysteresis on</b> (°C)	Do not adjust	Do not adjust	05 (Master) 02 (Slave)
35		P35 	<b>CH modulation hysteresis off</b> (°C)	Do not adjust	Do not adjust	05 (Master) 10 (Slave)
36		P36 	<b>DHW modulation hysteresis on</b> (°C)	Do not adjust	Do not adjust	03 (Master) 02 (Slave)
37		P37 	<b>DHW modulation hysteresis off</b> (°C)	Do not adjust	Do not adjust	03 (Master) 10 (Slave)
38		P38 	N/A	Do not adjust	Do not adjust	03
39		P39 	N/A	Do not adjust	Do not adjust	03
40		P40 	<b>Blocking time CH</b> (seconds) Minimum off period between CH demands to reduce cycling	00	30	00
41		P41 	<b>Blocking time DHW</b> (seconds) Minimum off period between DHW demands to reduce cycling	00	30	00
42		P42 	<b>Blocking time DHW to CH</b> (seconds) 0=switch with burner on (x10.2 seconds)	0	30	05
43		P43 	<b>DHW priority time over CH (secs)</b> 0 = DHW always has priority 1-120 mins The DHW has priority over CH until priority is switched back to CH.	0	120	30
44		P44 	<b>RMCI address</b> Note -01=RMCI off	Do not adjust	Do not adjust	00

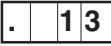
*continued.....*

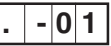
# INSTALLATION

## 39 ADVANCED CONTROLS ACCESS CONT'D



	Press	Display	Description	Lower Limit	Upper Limit	Factory Setting
45		P45 	<b>CH type</b>	Do not adjust	Do not adjust	00
46		P46 	<b>DHW type</b> x0=N/A x1=N/A x2=N/A x3=N/A x4=N/A x5=N/A x6=N/A x7=N/A x8=N/A x9=DHW ON/OFF call for heat 0x=3 way valve normally open 1x=hot water pump 2x=3way valve normally closed			19
47		P47 	<b>Manual fanspeed (for service use)</b> Note -1=off 00 = min fan speed 50 = mid rate 100 = max fan speed	-01	100	-01
48 49 50 51			<b>N/A</b>			
53			<b>Low/Off cycle</b> x0=off x1=on <b>Special pump function CH/DHW</b> 0x=CH normal pump function, DHW normal pump function 1x=CH pump off during heat request, DHW normal pump function 2x=CH pump normal function, DHW pump 5 sec on delay after heat request 3x=CH pump off during heat request, DHW pump 5 sec on delay after heat request			00
54			N/A	Do not adjust	Do not adjust	70
56			Slow start 0=CH only 1=CH & DHW	0	1	1

## 40 INFORMATION MODE (with code)



See Frame 32.

# INSTALLATION







## 41 FAN MODE (with code)

Press	Display	Description
	<b>FAN</b>	Fan speed
	<b>4800</b>	Actual fan speed e.g. 5500rpm

## 42 COMMUNICATION MODE (with code)

Press	Display	Description
	<b>CONN</b>	In this mode the communication between the boiler control module, optional control interface.
	<b>     </b>	No communication
	FLASHING <b>     </b>	There is only communication between the boiler control module and controls interface kit.
	FLASHING <b>     </b>	There is communication between all devices.

## 43 ERROR MODE (with code)

Press	Display	Description
	<b>ERRO</b>	In error mode the last error is shown, and the boiler status and readings at that time are available The 1st digit flashes and shows the current step. The last two digits show the error code.
	FLASHING <b>1 36</b>	Error code (see Table on pages 52 and 53 for full list)
	<b>2 00</b>	Boiler sequence at time of error (refer to Frame 30)
	<b>3 00</b>	Flow temperature T1 at time of error
	<b>4 00</b>	Return temperature T2 at time of error
	<b>5 - 36</b>	DHW temperature T3 at time of error
	<b>6 - 36</b>	Heat exchanger block temperature T4 at time of error

## 44 RETURN TO NORMAL OPERATING MODE

Press	Display	Description
	<b>0 21</b>	Press the reset button, or press 'MODE' several times, to return to (Stby) normal operating mode or if no buttons are touched the boiler will automatically reset after 15 mins.

# INSTALLATION

## 45 COMMISSIONING AND TESTING

### A. ELECTRICAL INSTALLATION

1. Checks to ensure electrical safety should be carried out by a competent person.
2. ALWAYS carry out the preliminary electrical system checks, i.e. earth continuity, polarity, resistance to earth and short circuit, using a suitable meter.

### B. GAS INSTALLATION

1. The whole of the gas installation, including the meter, should be inspected and tested for soundness and then purged in accordance with the recommendations of the relevant standards listed on page 4.

In IE refer to I.S.820:2002.

**WARNING.** Whilst effecting the required gas soundness test and purging air from the gas installation, open all windows and doors, extinguish naked lights and DO NOT SMOKE.

## 46 INITIAL LIGHTING

### NOTE.

#### MASTER MODULE LEADS THE SLAVE MODULE WITH SYNCHRONISED FIRING

1. Check that the system has been filled and the boiler is not air locked - air in the boiler could damage the heat exchanger. For this reason if an automatic air vent has been fitted it must never be off.
2. Check that all the drain cocks are closed and any valves in the flow and return are open.
3. Check that the GAS SERVICE COCKS ARE OPEN.
4. Check the indication on the pressure gauge. If the pressure is less than 0.8 bar the installation should be filled up first (sealed system only).
5. Switch the electricity supply ON to both modules and check that all the external controls are calling for heat. Check burner switch is set to on (Master module only).
6. The Master module will commence the ignition sequence. The circulation pump is energised, whilst operating a DHW valve if required. The fan is run up to starting speed and the air pressure switch activated. The fan then carries out a pre-purge before moving to ignition speed. A spark is started and the gas valve opens. Ignition must occur in 3 seconds and once detected the module starts operating.
7. The Slave module will now start to operate as described in no. 6, follow the sequence to ignition and operation. After the stabilisation period both modules modulate to achieve the set flow temperature at a restricted ramp up rate. As each module gets within 10°C of the set point it is free to modulate at normal rate.  
If after 5 attempts the module has failed to light then it will lock out. Press the reset button to restart the ignition sequence.
8. The gas valves are preset at the factory to nominal values. Dependant on site installation conditions (e.g. flue length) the module performance can vary slightly. To check the performance, measure the CO<sub>2</sub> values at maximum and minimum rates whilst adjusting the gas valves if necessary (Refer to Frame 51).
9. Operate the boiler for 10 minutes and check the gas rate (Table 1). You should obtain a value at least 90% of the nominal.
10. Set all the Module parameters (Master and Slave) to appropriate settings (refer to Frame 35).
11. Fit outer fascia panel to Slave Module and secure with 2 x M5 screws.
12. Fit the front panel by engaging the bottom retaining lugs and then pushing home.

## 47 GENERAL CHECKS

Make the following checks for correct operation.

1. The correct operation of ANY secondary system controls should be proved. Operate each control separately and check that the main burner or circulating pump, as the case may be, responds.
2. Water circulation system;
  - a. With the system HOT examine all water connections for soundness.
  - b. With the system still HOT, turn off the gas, water and electricity supplies to the boiler and drain down to complete the flushing process.
  - c. Refill and vent the system, clear all air locks and again check for water soundness.
  - d. Balance the system.
3. Check the condensate drain for leaks and check it is discharging correctly.
4. Finally set the controls to the User's requirements.

**Note.** If optional kits are fitted then refer to the instructions supplied with the kits.

## 48 HANDING OVER

### ROUTINE OPERATION

Full instructions covering routine lighting and operation of the boiler are given on the Lighting and Operation Instruction Label located behind the lower front door.

Draw the attention of the boiler owner or his representative to the Lighting and Operating Instruction Label. Give a practical demonstration of the lighting and shutting down of the boiler.

Describe the function of the boiler and system controls and show how they are adjusted and used.

Hand these Installation and Servicing Instructions/User's Instructions and Log book to the customer and request him to keep them in a safe place for ready reference. For IE, it is necessary to complete a "Declaration of Conformity" to indicate compliance to the appropriate standard.

### IMPORTANT.

Point out to the owner that the boiler must have regular maintenance and cleaning, at least annually, in order to ensure reliable and efficient operation. Regular attention will also prolong the life of the boiler and should preferably be performed at the end of the heating season.

After servicing, complete the service section of the log book and return to the owner or their representative.

Recommend that a contract for this work should be made with the regional gas authority or a CORGI registered heating installer. In IE servicing work must be carried out by a competent person.

## 49 SAFETY

It is the law that any service work must be carried out by a registered CORGI installer. In IE service work must be carried out by a competent person.

**WARNING. Always turn off the gas supply at the gas service cock, and switch off and disconnect the electricity supply to the appliance and any external controls before servicing or replacing components.**

**NOTE.** When the burner switch is in the off position the boiler control module remains live.

**IMPORTANT. After completing the servicing or replacement of components always:**

- Test for gas soundness.
- Test the burner manifold flanges for soundness. This can be done with leak detection spray whilst operating the boiler. The gas valve and controls must be shielded from the spray.

- Check the water system is correctly filled and free of air. Air in the boiler could cause damage to the heat exchanger. For this reason if an automatic air vent is fitted it must never be shut off.
- Check the inner front and outer jacket panels are correctly fitted.
- With the system hot examine all water connections for soundness.
- Check the gas rate and measure the combustion CO/CO<sub>2</sub> content. Refer to Frame 51 for reference on how to force the burner to maximum and minimum gas rates. The CO/CO<sub>2</sub> ratio of the flue gas on each module should not be greater than 0.004 ratio. The CO<sub>2</sub> values should be correct to the figures in Table 1 on Page 2.
- Carry out functional checks as appropriate.

## 50 SERVICING SCHEDULE

To ensure the continued safe and efficient operation of the appliance it is recommended that it is checked at regular intervals and serviced as necessary. The frequency of servicing will depend upon the installation condition and usage but should be carried out at least annually.

**Ideal Stelrad Group** does not accept any liability resulting from the use of unauthorised parts or the repair and servicing of appliances not carried out in accordance with the Company's recommendations and specifications.

### Note.

*Some aluminium oxide build-up within the heat exchanger assembly is quite usual with this type of condensing boiler. Though removal and cleaning is recommended annually, the heat exchanger, sump and condensate trap must be inspected and cleaned after a maximum of 2 years operation.*

1. Light the boiler and carry out function checks, noting any operational faults.
2. Run the boiler for 10 minutes and then check the gas consumption rate. Refer to Frame 51 for reference on how to force the burner to maximum and minimum rates.
3. For correct boiler operation the CO/CO<sub>2</sub> ratio of the flue gas on each module should not be greater than 0.004 ratio and the CO<sub>2</sub> values should be correct to the figures in Table at front of book. If this is the case and the gas input is at least

90% of the nominal, once compliance with the note above is ensured, then no further action need be taken. If not proceed to 4. Refer to Frames 52 to 58 for guidance.

4. Refer to Frame 49.
5. Remove and inspect the fan/venturi assembly. Refer to Frame 53.
6. Remove the burner manifold and inspect the electrodes and sightglass. Refer to Frames 54 and 61.
7. Remove and clean the burner. Refer to Frame 55.
8. Inspect the heat exchanger through the burner opening. Optionally remove the inspection covers on the left hand side of the heat exchanger. If there are signs of aluminium oxide build up, spray water down the flueways taking care not to get water on the gas valve and controls. Refer to Frame 56.
9. Remove the sump cover and scrape out any deposits. Refer to Frame 57.
10. Clean the condensate trap. Refer to Frame 58.
11. Check that the flue terminal and air inlet are unobstructed and that the fluing and ducting are correctly sealed.

### REPEAT PROCEDURE FOR BOTH SLAVE AND MASTER MODULES.

12. After servicing refer to Frame 49 for final safety checks.

## 51 GAS VALVE ADJUSTMENT

The boiler contains 2 Modules with individual gas valves. Both must be adjusted.

### Maximum rate adjustment

1. Switch the boiler on and operate for 10 minutes.
2. To ensure the boiler operates at maximum rate without modulating set the fan speeds to maximum.
3. Remove the outer fascia panel on the Slave Module (see Frame 52).
4. To set the fan speed to maximum. Press and hold in the 'mode' and '+' buttons simultaneously on the Master Module. The display will show 

H			
---	--	--	--

 as the first digit indicating the boiler is operating at maximum rate.  
Repeat on the Slave Module.
5. Connect a suitable flue analyser to the flue sampling point of the Master Module (see Frame 12).
6. Using the maximum rate adjustment screw, adjust the master module gas valve until the CO<sub>2</sub> measures 9.7% ± 0.2 (nb. clockwise reduces CO<sub>2</sub>).
7. Connect a suitable flue analyser to the flue sampling point of the Slave Module (see Frame 12).
8. Using the maximum rate adjustment screw, adjust the Slave Module gas valve until the CO<sub>2</sub> measures 9.7% ± 0.2 (nb. clockwise reduces CO<sub>2</sub>).

### Note.

*It is possible to switch off the CH/DHW systems if the mode and +/- buttons are not held simultaneously. Refer to Frame 30 under the heading CH/DHW Systems for guidance.*

### Minimum rate adjustment

9. To ensure the boiler operates at minimum rate without modulating, set the fan speeds to minimum.
10. To set the fan speed to minimum. Press and hold in the 'mode' and '-' buttons simultaneously on the Master Module. The display will show 

L			
---	--	--	--

 as the first digit indicating the boiler is operating at minimum rate.  
Repeat on the Slave Module.
11. Connect a suitable flue analyser to the flue sampling point of the Master Module - see Frame 12.
12. Remove the protective cap and then using the offset adjustment screw, adjust the valve on the master module until the CO<sub>2</sub> value measures 9.5% ± 0.2 (nb. anti-clockwise reduces CO<sub>2</sub> level). The offset adjustment is a lot more sensitive than the throttle adjustment.
13. Connect a suitable flue analyser to the flue sampling point on the Slave Module (see Frame 12).
14. Remove the protective cap and then using the offset adjustment screw, adjust the valve on the Slave Module until the CO<sub>2</sub> value measures 9.5% ± 0.2 (nb. anti-clockwise reduces CO<sub>2</sub> level).
15. Re-check the CO<sub>2</sub> level at maximum rate and repeat steps 3 to 15 if necessary.
16. Press the '+' and '-' buttons simultaneously to return to normal operating mode.
17. Seal adjustment screw with tamper proof paint.

Maximum Rate Adjustment Screw  
(Firstly remove plastic cap for access)

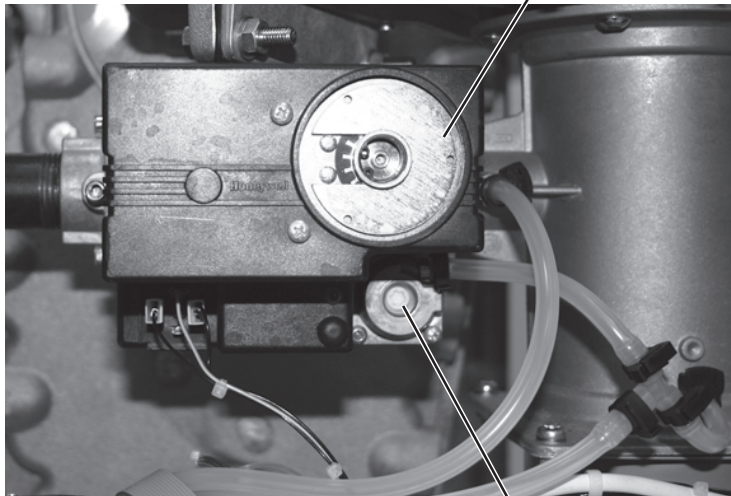

Offset Adjustment Screw  
(Firstly remove plastic cap for access)

## 52 CASING REMOVAL AND ACCESS

### Front Panels

1. Pull the front panel forwards at the top, lift off the bottom retaining lugs and remove.



2. Loosen 3 screws on one side of the inner front panel and undo the 3 screws from the other side. The panel will now slide to one side for removal. **REPEAT PROCEDURE FOR SLAVE MODULE.**



### Control Fascia Panel (MASTER MODULE)

3. Remove the 2 screws securing the control fascia panel. Carefully lift it slightly and lower the top forwards allowing it to rest on the hinge lugs.

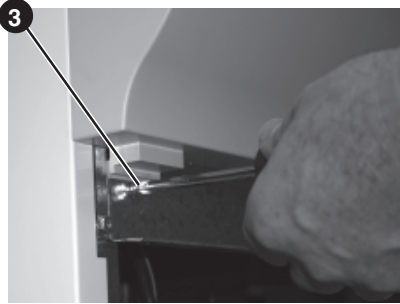

4. To remove completely, release the ribbon cable from the display board, raise slightly and withdraw.

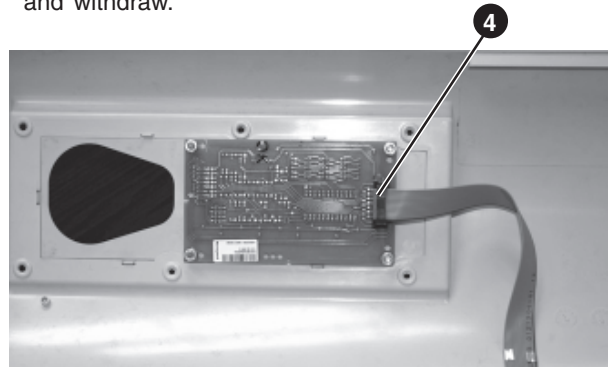

### Control Fascia Panel (SLAVE MODULE)

5. Remove 2 screws securing the outer fascia panel. Lift and remove fascia.



6. Remove 2 screws securing inner fascia panel. Lift and support panel and remove ribbon cable and remove fascia.



### Top Panel

7. Remove 2 screws from rear top panel. Lift and remove panel

### Side Panels

8. Remove 2 screws from rear and 2 screws from front of each side panel. Lift from Frame and remove.

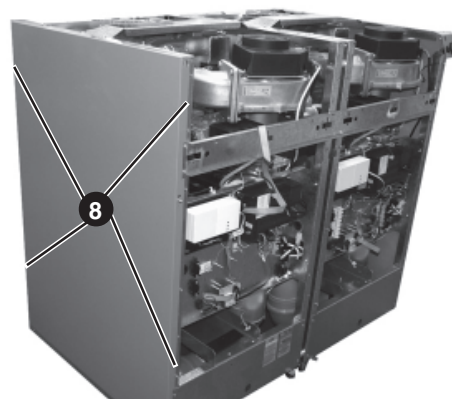

## 53 REMOVAL OF FAN / VENTURI INSPECTION

1. Refer to Frame 49.
2. Remove the jacket front, inner front, jacket right, jacket top and controls fascia panels. (Refer to Frame 52).
3. Disconnect the electrical connections from the fan.
4. Remove 4 bolts securing inlet air pipe/silencer to the venturi taking care to retain O ring seal.
5. Whilst providing temporary support for the gas valve remove the 4 screws securing the gas valve to the venturi
6. Remove sensing pipe from venturi.
7. Whilst providing temporary support for the fan/venturi remove the 4 fasteners securing the fan outlet connection. Lift the fan/venturi assembly clear of the boiler taking care to retain the fan outlet gasket.
8. Remove the 4 screws securing the venturi to the fan inlet, taking care to retain the O ring.
9. Re-assemble in reverse order replacing any seals/gaskets which show signs of wear.

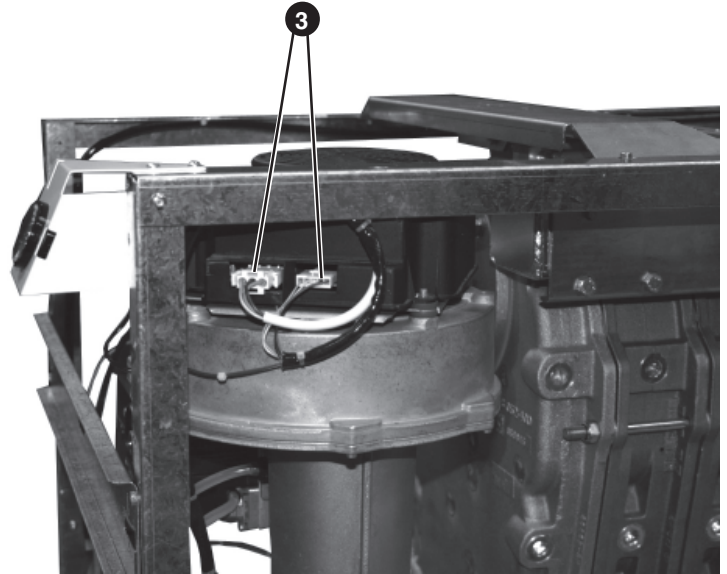

**REPEAT PROCEDURE FOR SLAVE MODULE.**

10. Refer to Frame 49 for final safety checks.

## 54 REMOVAL OF BURNER MANIFOLD

1. Refer to Frame 49.
2. Refer to Frame 53 for removal of fan/venturi assembly.
3. Disconnect the ignition and earth lead from the electrodes.
4. Whilst providing temporary support for the burner manifold remove the 4 retaining nuts.
5. Withdraw the burner manifold from the boiler taking care not to damage the electrodes.
6. Re-assemble in reverse order, replacing any seals/gaskets which show signs of wear. The nyloc nuts should be renewed. Ensure the short earth lead is secured under the top LH nut.

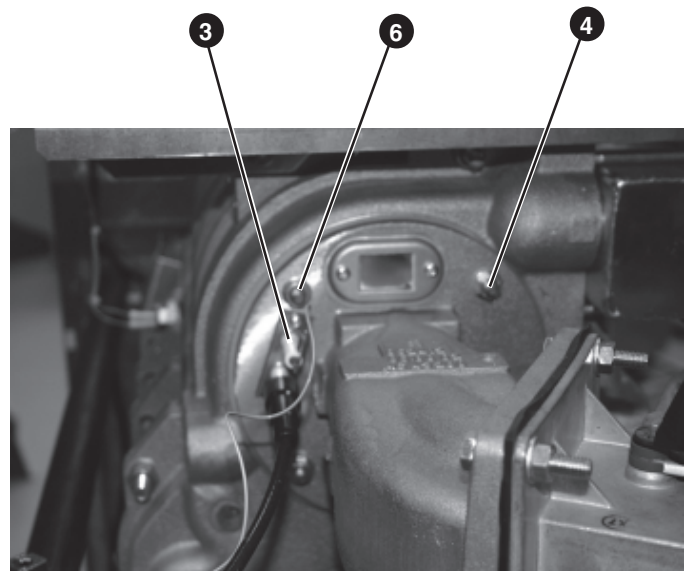

**REPEAT PROCEDURE FOR SLAVE MODULE.**

7. Refer to Frame 49 for final safety checks.

## 55 REMOVAL / CLEANING OF BURNER

1. Refer to Frame 49.
2. Refer to Frame 54 for removal of burner manifold.
3. Remove the gasket from the 4 studs.
4. Draw the burner out of the heat exchanger.
5. The burner can be cleaned on the inside surface using a soft brush and/or vacuum. The metal fibre outer surface must not be brushed. If the burner is showing signs of damage it must be replaced.
6. Re-assemble in reverse order replacing any seals/gaskets which show signs of wear. When re-fitting the burner there are 2 small lugs cast into the end of the combustion chamber which support the end of the burner.

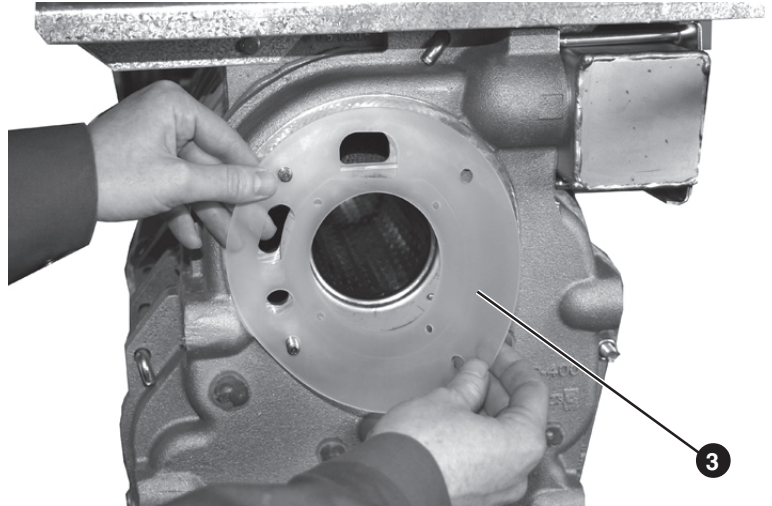

### **REPEAT PROCEDURE FOR SLAVE MODULE.**

7. Refer to Frame 49 for final safety checks.

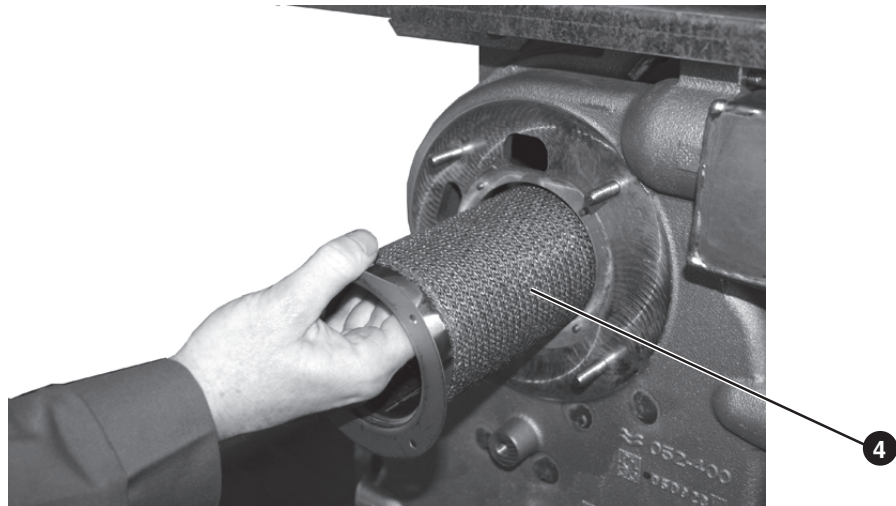

## 56 REMOVAL OF HEAT EXCHANGER INSPECTION COVERS

1. Refer to Frame 49.
2. Remove the jacket front, inner front, controls fascia, top and left side panels. (Refer to Frame 52).
3. Remove the 6 securing nuts on each inspection cover and withdraw, taking care to retain the gasket.
4. Re-assemble in reverse order replacing the gasket if it is showing signs of wear.
5. Refer to Frame 49 for final safety checks.

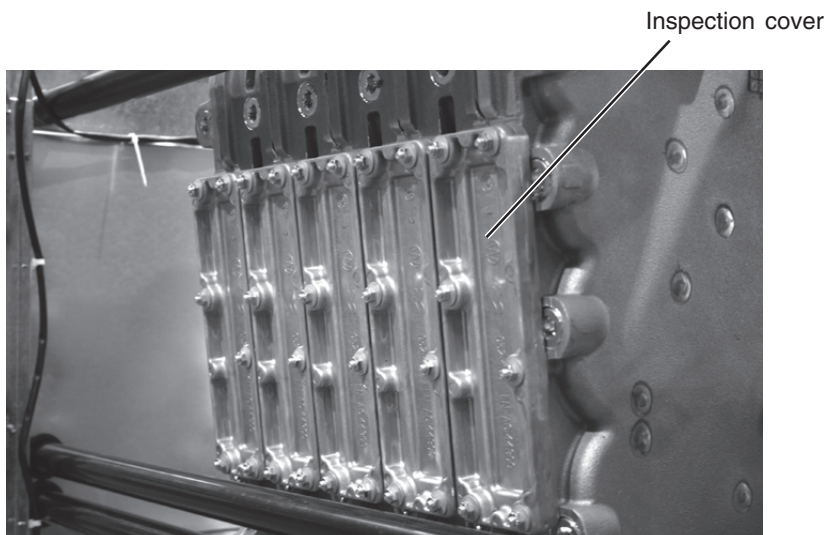

## 57 REMOVAL OF SUMP COVER

1. Refer to Frame 49.
2. Remove the jacket front and inner front panels. (Refer to Frame 52).
3. Remove the 6 nuts and withdraw the sump cover plate taking care to retain the gasket.
4. Scrape out any deposits within the sump.
5. Re-assemble in reverse order replacing the sump cover plate gasket if it is showing signs of wear.

**REPEAT PROCEDURE FOR SLAVE MODULE.**

6. Refer to Frame 49 for final safety checks.

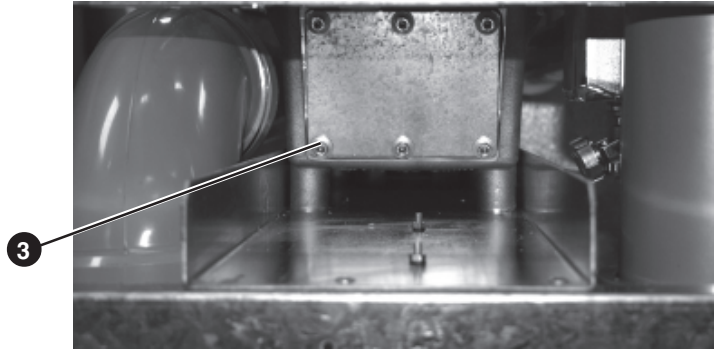

## 58 CLEANING CONDENSATE TRAP

1. Refer to Frame 49.
2. Remove the jacket front, inner front, controls fascia, top and side panels. (Refer to Frame 52).
3. Place a container beneath the condensate trap to collect the condensate contained within.
4. Remove bottom nut/plug from the condensate trap whilst collecting the condensate which will drain out.
5. Withdraw the cartridge and ball from within the condensate trap. Thoroughly clean the cartridge and ball by flushing with water.
6. If deposits are visible in the condensate trap body, it can be removed by unscrewing the inlet and outlet nuts. Thoroughly flush the body with water.
7. Re-assemble in reverse order, replacing the condensate trap if there are signs of wear to any seals or the ball.

**REPEAT PROCEDURE FOR SLAVE MODULE.**

8. Refer to Frame 49 for final safety checks.

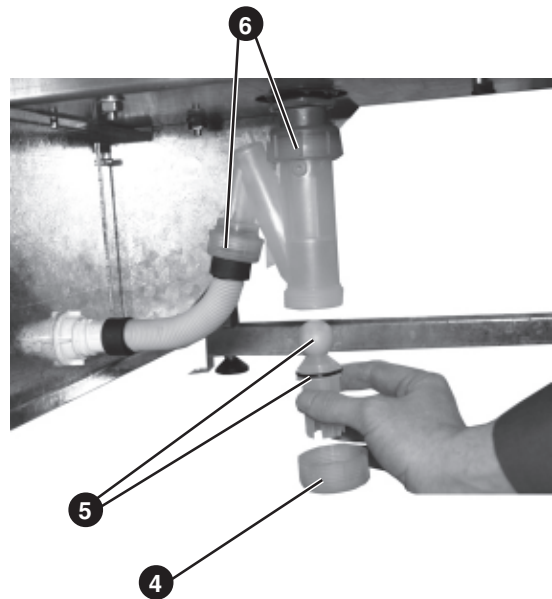

## 59 GAS VALVE REPLACEMENT

1. Refer to Frame 49.
2. Remove the jacket front, inner front and control fascia panels. (Refer to Frame 52).
3. Remove the 4 screws securing the controls fascia support bracket and withdraw.
4. Disconnect the electrical connections from the gas valve.
5. Release the securing clip and disconnect the pressure sensing tube from the gas valve.
6. Whilst providing temporary support for the inlet gas pipe, remove the 4 screws securing the inlet flange.
7. Whilst providing temporary support for the gas valve, remove the 4 screws securing the gas valve outlet.
8. Withdraw the gas valve taking care to retain the inlet and outlet O rings.
9. Re-assemble in reverse order. Re-secure the clip over the pressure sensing tube using pliers to apply the grip. Replace gas valve inlet/outlet O rings if showing signs of wear.
10. Refer to instruction sheet with spare gas valve for correct setting procedure.
11. Refer to Frame 49 for final safety checks.

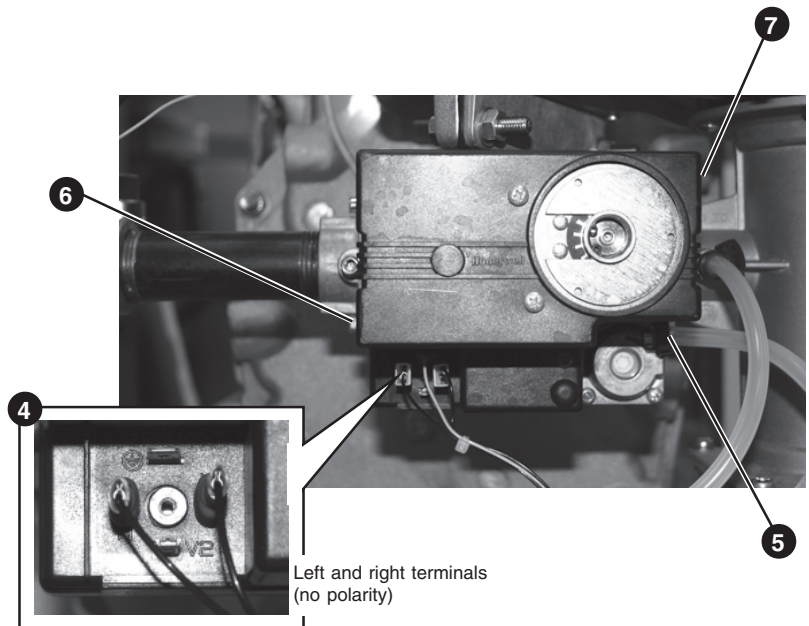

## 60 AIR PRESSURE SWITCH REPLACEMENT

1. Refer to Frame 49.
2. Remove the jacket front and inner front panels. (Refer to Frame 52).
3. Remove the 2 electrical connections from the air pressure switch (no polarity) which is located at the top rear of the main control panel.
4. Release the securing clips and disconnect the pressure sensing tubes.
5. The air pressure switch can now be unclipped from its supporting cradle.
6. Re-assemble in reverse order. Connect the sensing tube from the T-piece to P1 and the sensing tube from the gas valve outlet elbow to P2.
7. Refer to Frame 49 for final safety checks.

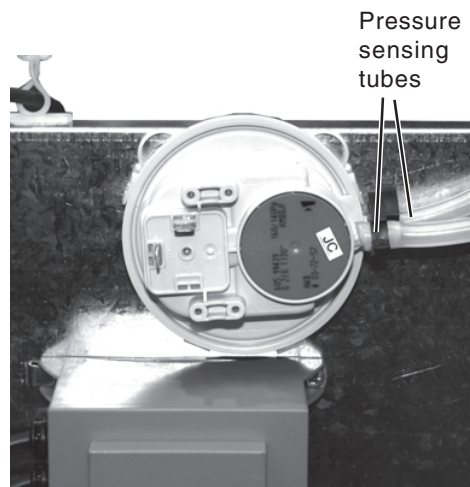

## 61 IGNITION/DETECTION ELECTRODE TESTING/REPLACEMENT

1. Refer to Frame 49.
2. Remove the jacket front and inner front panels. Refer to Frame 52.
3. It is possible to measure the ionisation current with a voltmeter set at 0-10VDC. (0-10VDC = 0-10 micro amps ionisation current).
4. With the boiler running, connect a meter between the terminal marked  $\varnothing$  and earth.
5. A reading below 3V indicates a fault.
6. To replace the ignition/detection electrode remove the controls fascia, pull off the HT and earth leads from the spark/detection electrode.
7. Remove the 2 nuts and washers.
8. Check the electrode gap is 4.0mm.
9. Replace the electrode using the new gasket provided.
10. Re-assemble in reverse order.
11. Refer to Frame 49 for final safety checks.

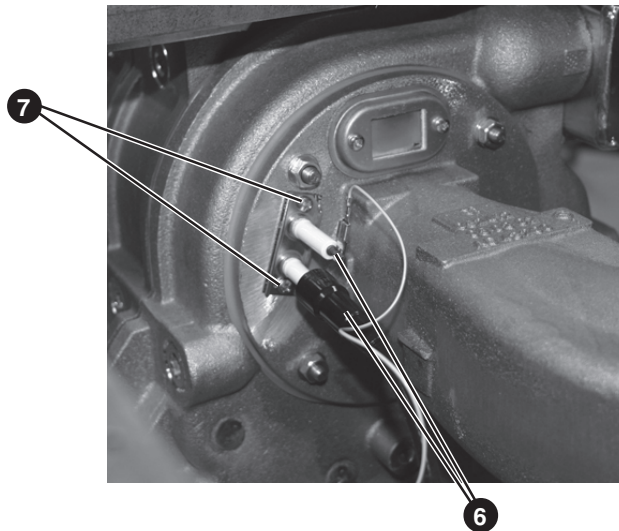

## 62 PRESSURE GAUGE REPLACEMENT (MASTER BOILER ONLY)

1. Refer to Frame 49, then:
2. Remove the jacket front, control fascia, top, and right side panels. (Refer to Frame 52).
3. Unscrew the nut retaining the capillary from the self sealing fitting. (Refer to 'A' in Frame 63).
4. Compress the retaining lugs and push forwards to remove the gauge from the bracket.
5. Replace the pressure gauge.
6. Reassemble in reverse order.
7. Refer to Frame 49 for final safety checks.



## 63 WATER PRESSURE SWITCH REPLACEMENT

1. Refer to Frame 49.
2. Remove the jacket front, control fascia, top and side panel. (Refer to Frame 52).
3. Isolate water circuit and drain boiler.
4. Pull off the electrical connections (no polarity) from the pressure switch.
5. Unscrew the water pressure switch
6. Fit the new water pressure switch.
7. Re-assemble in reverse order.
8. Re-fill the system ensuring all the air in the heat exchanger is vented.
9. Refer to Frame 49 for final safety checks.

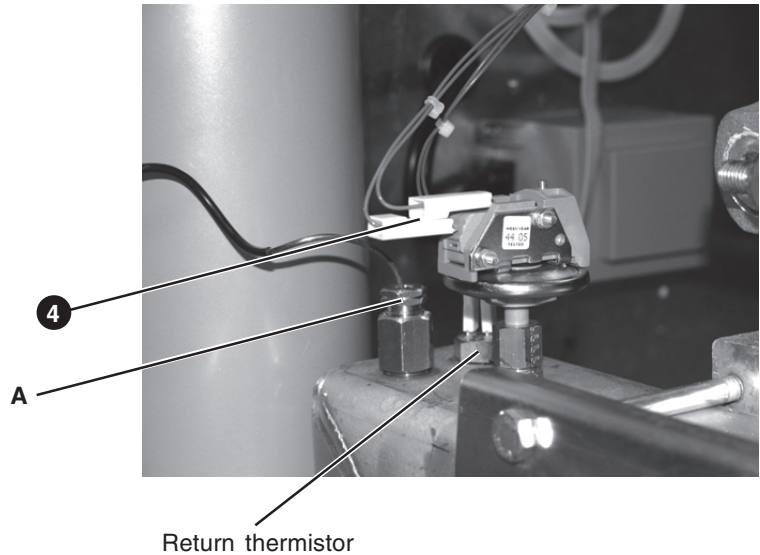

## 64 FLOW / RETURN / HEAT EXCHANGER / FLUE THERMISTOR REPLACEMENT

1. Refer to Frame 49.
2. Remove the jacket panels as appropriate. (Refer to Frame 52).
3. Isolate water circuit and drain boiler.
4. Pull off the electrical connections from the thermistor.
5. Unscrew the thermistor.
6. Fit the new thermistor with built in 'O' ring seal. Do not overtighten.
7. Re-assemble in reverse order.
8. Refill the system ensuring all the air in the heat exchanger is vented.
9. Refer to Frame 49 for final safety checks.

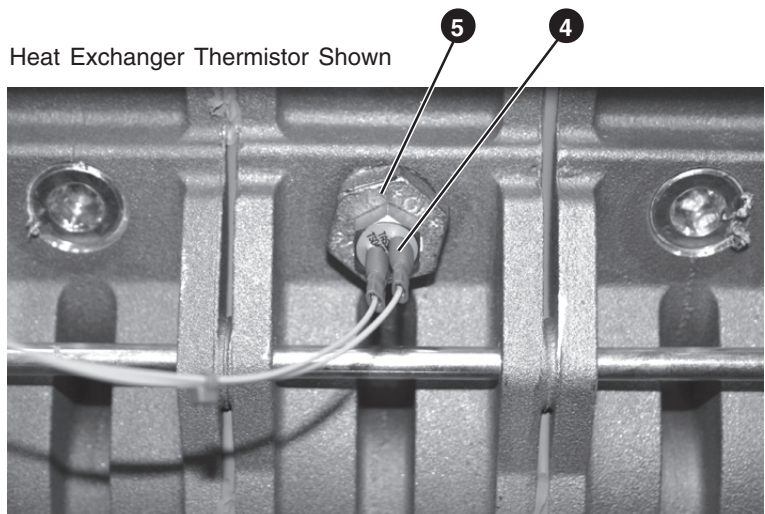

## 65 TRANSFORMER REPLACEMENT

1. Refer to Frame 49.
2. Remove the jacket front, inner front, controls fascia and top panels. (Refer to Frame 52).
3. Disconnect the transformer connection from the boiler control module. (Refer to 'A' in Frame 66).
4. Remove the 2 screws on the left side of the transformer whilst supporting its weight.
5. Disengage the transformer from the 2 retaining lugs by moving it to the left. Remove from boiler.
6. Re-assemble in reverse order.
7. Refer to Frame 49 for final safety checks.

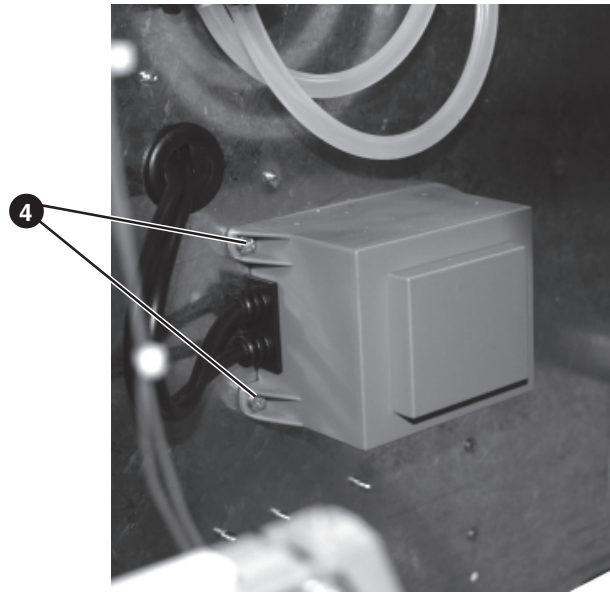

## 66 CONTROL MODULE REPLACEMENT

1. Refer to Frame 49.
2. Remove the front and inner front panels. (Refer to Frame 52).
3. Disconnect the electrical connections from the module.
4. Remove the 4 screws securing the control module to the main control panel.
5. Re-assemble in reverse order.
6. Refer to Frame 49 for final safety checks.

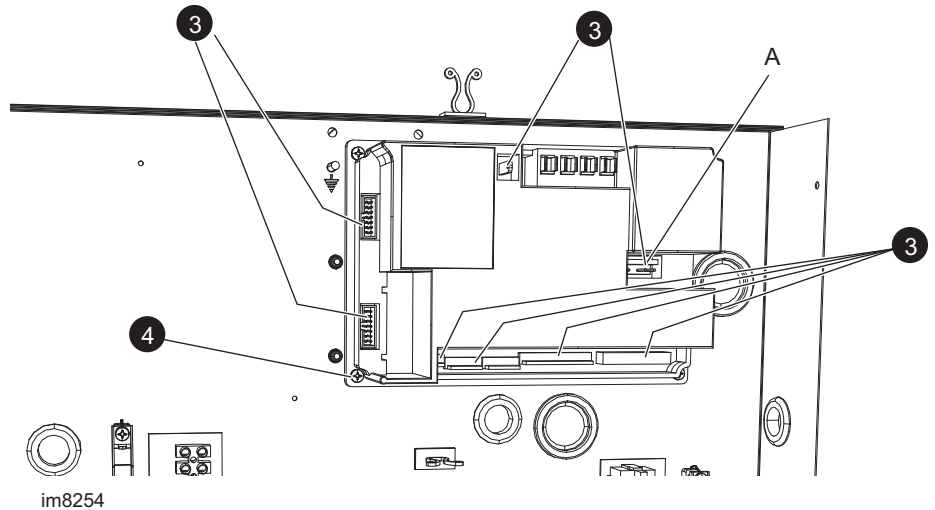

**Note.** Control module must be fitted with clip-in Opentherm interface device.

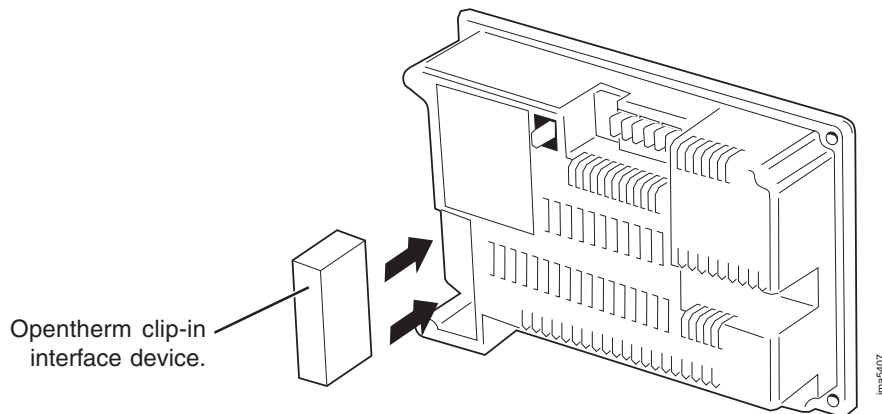

## 67 OT CENTER REPLACEMENT

1. Refer to Frame 49.
2. Remove the front and inner front panels (Refer to Frame 52).
3. Squeeze tab and pull to remove connection lead.
4. Firmly pull up and down on module to remove.
5. Replace with new module after setting switches 'S1' and 'S2' according to Frame 22.
6. Plug in communication lead to either common socket.
7. Re-assemble in reverse order ensuring OT Center module is pushed fully home to its backing plate.
8. Refer to Frame 49 for final safety checks.

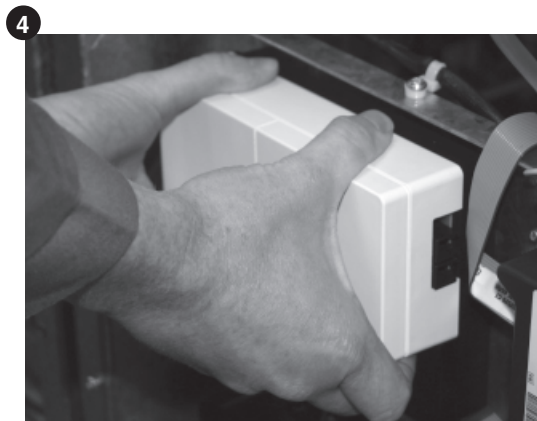

## 68 DISPLAY BOARD REPLACEMENT

1. Refer to Frame 49.
2. Remove the front and inner front panels. Lower the controls fascia. (Refer to Frame 52).
3. Disconnect the electrical connection from the display board.
4. Undo and remove the 4 plastic nuts.
5. Lift the display board from the 4 studs.
6. Fit the new display board and re-assemble in reverse order.
7. Refer to Frame 49 for final safety checks.

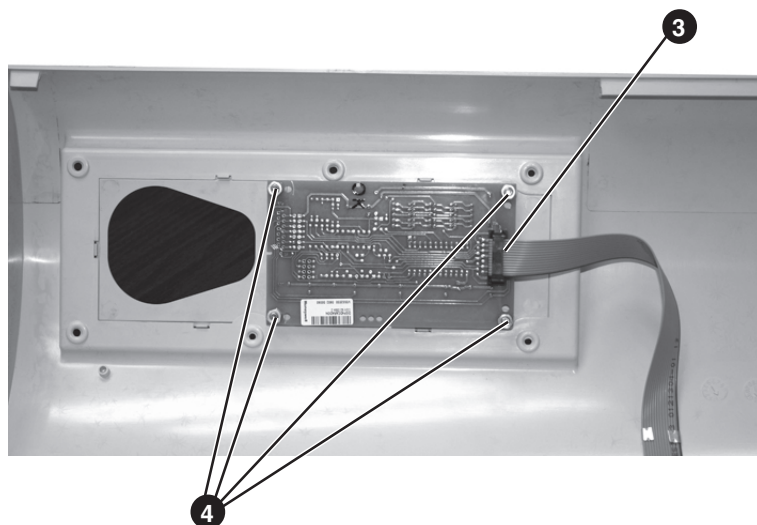

## 69 MOTORISED DAMPER MOTOR REPLACEMENT

1. Refer to Frame 49.
2. Loosen 2 securing screws from motor cover and remove cover.
3. Disconnect electrical connections.
4. Remove 2 x M5 nuts and washers located behind mounting plate and remove motor.
5. Replace with new motor.
6. Re-assemble and re-wire in reverse order.
7. Refer to Frame 49 for final safety checks.

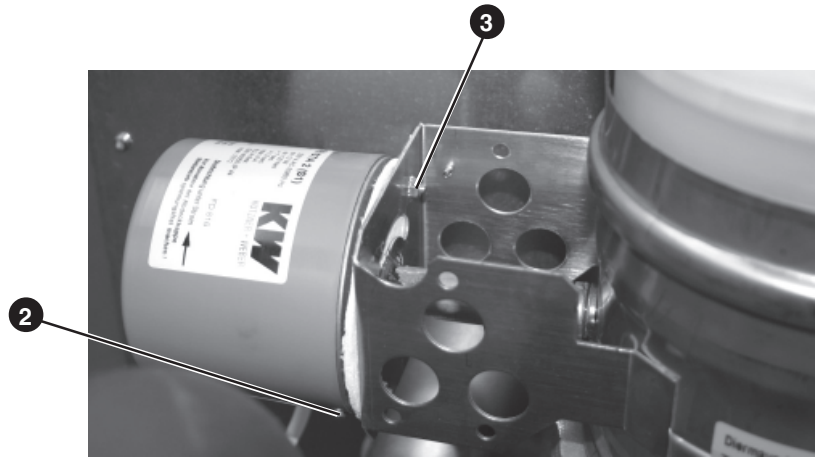

## 70 AIR DAMPER REPLACEMENT

1. Refer to Frame 49.
2. Remove front and inner front panels (Refer to Frame 52).
3. If replacing Slave Module air damper first remove boiler LHS panel (Refer to Frame 52).
4. Remove 4 x M6 nuts, bolts and washers locating air duct flange to venturi assembly on the module that the air damper is to be removed.
5. Remove 2 x M5 nuts retaining air duct lower support bracket on module that the air damper is to be removed. Remove bracket.
6. Pull air duct assembly forward and pull air duct flanges out of automatic air duct inlet and outlet connections.

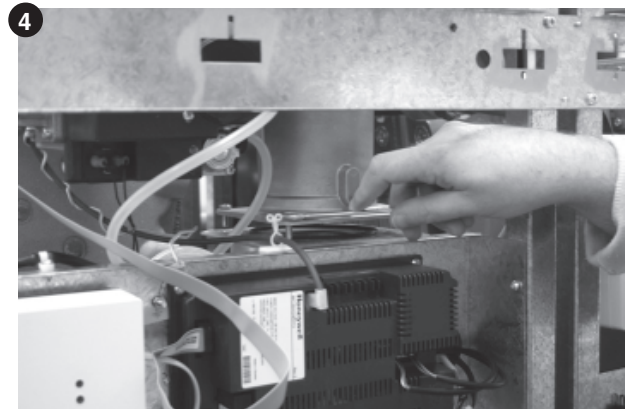

### Inspection and Replacement:

7. Check butterfly flaps within air damper move freely without sticking. Remove any dust/debris with a soft brush. Check integrity of O-ring seals within flange connectors.
8. Re-fit damper ensuring it is orientated such that the butterfly flaps open inwards towards the front of the boiler module. Also ensure inspection window faces uppermost.
9. Re-fit ductwork in reverse order to disassembly. Check venturi flange O-ring seal is in good condition and correctly located in its groove during assembly.
10. Refer to Frame 49 for final safety checks.

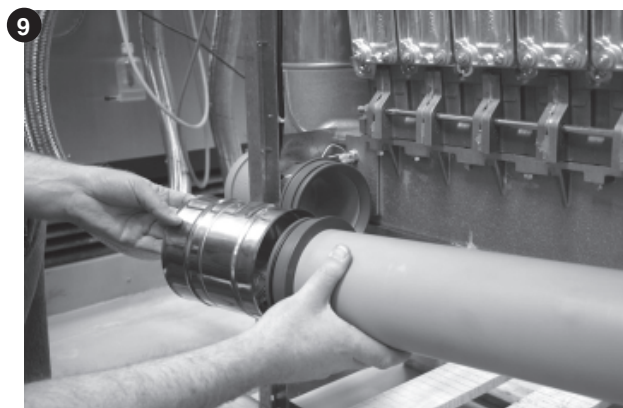
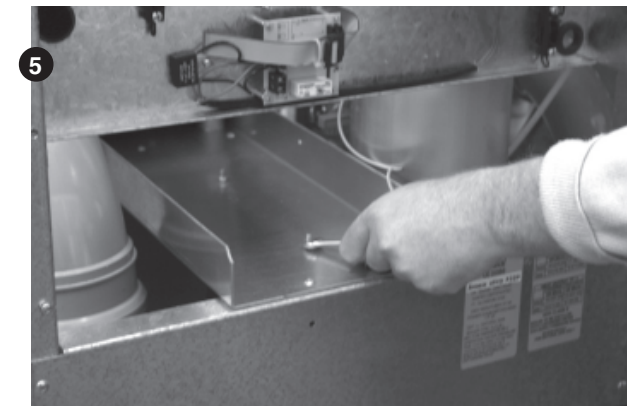





## FAULT FINDING

### MASTER AND SLAVE BOILER CONTROL MODULE ERROR CODES CONTINUED

Code	Description	Action
29	Incorrect tacho signal from fan	Check wiring to fan. If wiring OK replace fan.
30	Flow/return temperature differential too high	Check no air in system or boiler Check adequate flow of water through boiler
31	Flow thermistor short circuit	Check wiring Disconnect terminals from thermistor & confirm short circuit using meter Replace thermistor
32	Return thermistor short circuit	Check wiring Disconnect terminals from thermistor & confirm short circuit using meter Replace thermistor
33	Tank sensor short circuit	Not fitted check parameter 46 settings
35	Flue thermistor short circuit	Check wiring Disconnect terminals from thermistor & confirm short circuit using meter Replace thermistor
36	Flow thermistor open circuit	Check wiring Disconnect terminals from thermistor & confirm open circuit using meter Replace thermistor
37	Return thermistor open circuit	Check wiring Disconnect terminals from thermistor & confirm open circuit using meter Replace thermistor
38	Tank sensor open circuit	Not fitted check parameter 46 settings
40	Flue thermistor open circuit	Check wiring Disconnect terminals from thermistor & confirm open circuit using meter Replace thermistor
44	Internal Failure	Check wiring harness & connections If wiring OK replace control module
52	Flue gas temperature too high	Check no air in system or boiler Check adequate flow of water through boiler
60	Error reading parameters	Press reset. If fault keeps re-occurring replace control module.
61	Air pressure switch closed when it should be open	Check for blockages in air pressure switch sensing pipes Check air pressure switch and replace if necessary
107	Heat exchanger thermistor short circuit	Check wiring Disconnect terminals from thermistor & confirm short circuit using meter
108	Heat exchanger thermistor open circuit	Check wiring Disconnect terminals from thermistor & confirm open circuit using meter Replace thermistor
109	Heat exchanger temperature too high	Check no air in system or boiler Check adequate flow of water through boiler
110	Heat exchanger temperature too low	Check no air in system or boiler Check adequate flow of water through boiler
111	Heat exchanger to return temperature differential too high	Check no air in system or boiler Check adequate flow of water through boiler
112	Heat exchanger temperature rise too fast	Check no air in system or boiler Check adequate flow of water through boiler
113	No valid mains frequency detected	Check power supply to boiler
114	Invalid or conflicting cascade address	Press reset. If fault keeps re-occurring replace control module.
115	Internal error	Check wiring harness & connections If wiring OK replace control module



## SHORT LIST OF PARTS

The following are parts commonly required as replacements, due to damage or expendability.

A full list of spares is held by **Ideal Stelrad Group** distributors and merchants.

Their failure or absence will affect the safety and/or performance of this appliance.

When ordering spare parts please quote:

1. Boiler model
2. Boiler serial no. (refer to the data plate on boiler\*)
3. Boiler P.I. No. (refer to the data plate on boiler\*)
4. Description
5. Quantity
6. Part no.

*\* Note. Data plate, (refer to Frame 7), can be accessed by removing front panel, (refer to Frame 52).*

When replacing any part on this appliance use only spare parts that you can be assured conform to the safety and performance specification that we require. Do not use reconditioned or copy parts that have not been clearly authorised by Ideal boilers.

**Note.** Each spares kit ordered contains only one replacement part.

Key No.	Description	Qty. Per Module	Part No.
3	Pressure Gauge	1	172 669
8	Fan	1	174 376
9	Gas Valve	1	174 378
	F320	1	174 378
	F400-F560	1	174 379
12	Control Module	1	174 667
	F320 Master	1	174 667
	F320 Slave	1	174 668
	F400 Master	1	174 669
	F400 Slave	1	174 670
	F480 Master	1	174 671
	F480 Slave	1	174 672
	F560 Master	1	174 673
	F560 Slave	1	174 674
13	Display Board	1	172 660
14	Alarm / Boiler Run Relays Board	1	174 391
21	Water Pressure Switch	1	172 667
26	Burner	1	174 407
	F320	1	174 407
	F400	1	174 408
	F480	1	174 409
	F560	1	174 410
28	Gasket - Burner Manifold	1	174 412
29	Gasket - Fan	1	174 413
31	Thermistor (temperature sensor)	4	174 415
33	Air Pressure Switch	1	174 418
36	Transformer	1	172 657
37	Relay	2	172 658
47	Ignition / Detection Electrode	1	174 432
51	Control Module Fuses	1	172 663
52	Mains Fuse	1	174 449
54	OT Center	1	174 679
59	Flue Damper Actuator	1	174 686

# SHORT LIST OF PARTS

## 72 SHORT LIST

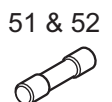
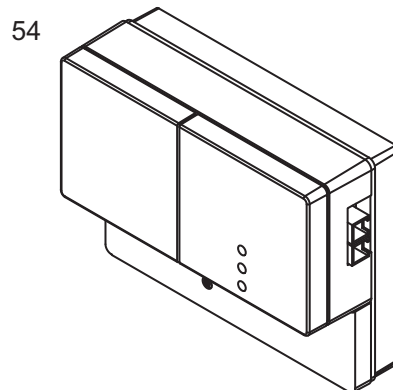
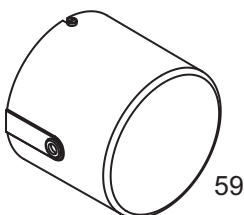
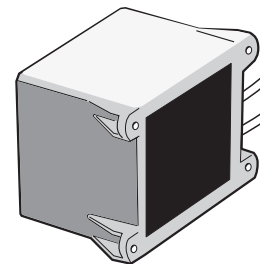
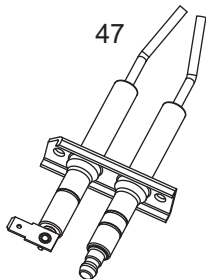
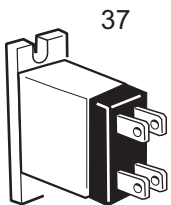
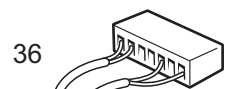
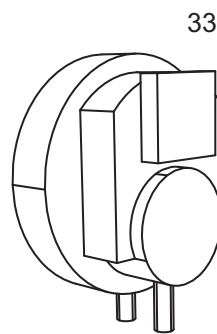
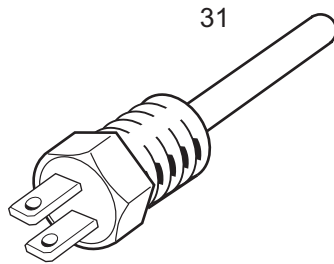
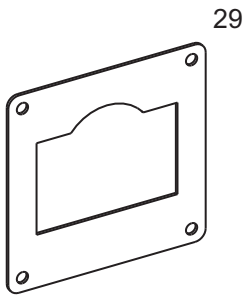
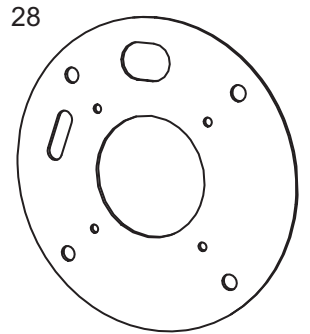
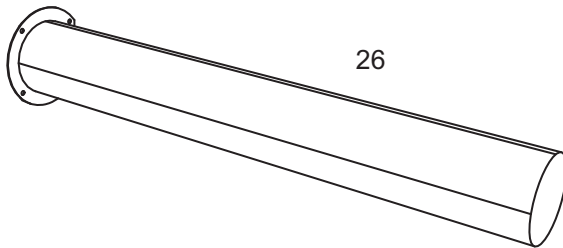
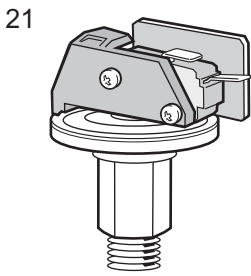
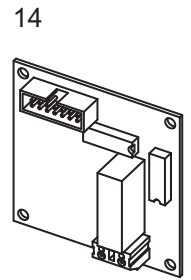
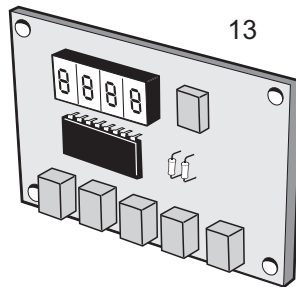
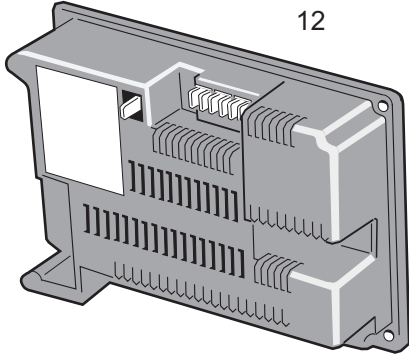
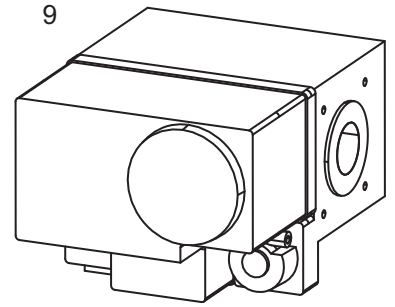
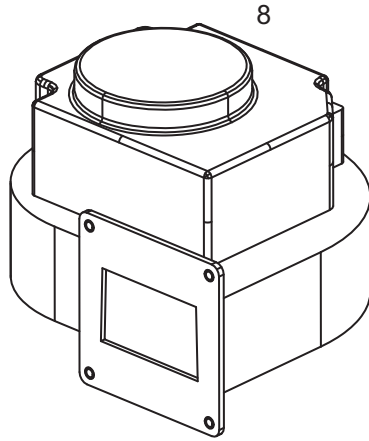
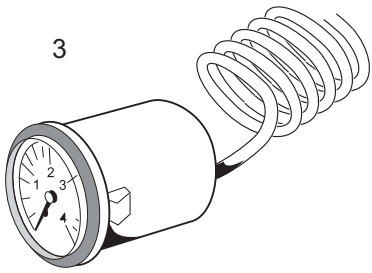

im8475b

**NOTES**

## NOTES

# NOTES

### **Technical Training**

The Ideal Boilers Technical Training Centre offers a series of first class training courses for domestic, commercial and industrial heating installers, engineers and system specifiers. For details of courses please ring: ..... 01482 498 432

**Ideal Boilers**, P.O. Box 103, National Ave, Kingston upon Hull, HU5 4JN. Telephone: 01482 492 251 Fax: 01482 448 858. Registration No. London 322 137.

**Ideal Stelrad Group** pursues a policy of continuing improvement in the design and performance of its products. The right is therefore reserved to vary specification without notice.



***i* Ideal** BOILERS  
The High Efficiency Pioneers



Ideal Stelrad Group

***Ideal Installer/Technical Helpline: 01482 498 376***  
***www.idealboilers.com***

# users guide

## **i**max xtra

Your Ideal users guide

See reverse for **i**max xtra installation & servicing guide

**Models F320, F400, F480, F560**

When replacing any part on this appliance, use only spare parts that you can be assured conform to the safety and performance specification that we require. Do not use reconditioned or copy parts that have not been clearly authorised by Ideal Boilers.

**i** Ideal BOILERS  
The High Efficiency Pioneers

## **imax xtra**

**Natural Gas only**

**PI No. 0063 BR 3123**

**Destination Countries: GB,IE**

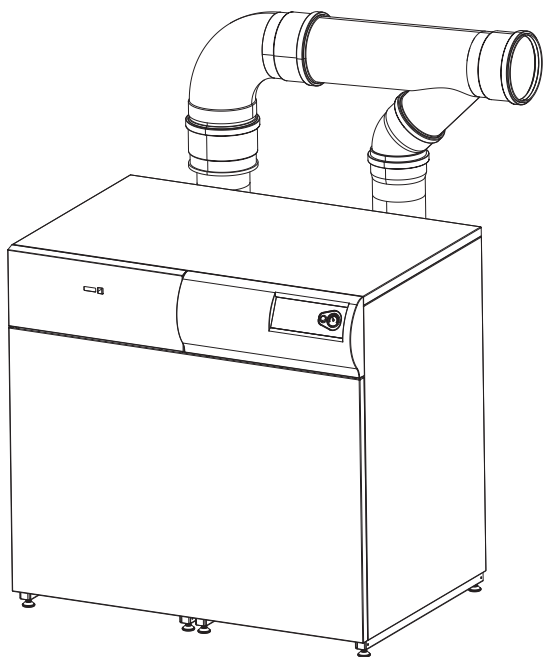

## **Introduction**

The **imax xtra** boilers are fully automatically controlled, floor standing, fanned, super efficient condensing appliances.

Due to the very high efficiency, condensate is produced from the flue gases and this is drained to a suitable disposal point through the plastic waste pipe at the bottom of the boiler. A condensate 'plume' will also often be visible at the flue terminal.

## **Safety**

### **Current Gas Safety (Installation & Use) Regulations or rules in force.**

In your own interest, and that of safety, it is the law that this boiler must be installed and maintained by a CORGI registered installer or in IE a competent person, in accordance with the above regulations.

The appliance should be serviced at least once a year by a CORGI registered installer or in IE a competent person.

*It is essential that the instructions in this booklet are strictly followed, for safe and economical operation of the boiler.*

## **Electricity Supply**

The appliance must be earthed.

Supply 230 V - 50 Hz. The fusing should be 7A for F320-F560.

This appliance is intended to be connected to the supply via two double-pole switches, having a 3mm contact separation in both poles, serving only the boiler and system controls. Alternatively, two 3-pin UNSWITCHED sockets may be used.

## **Important Notes**

- This appliance must not be operated without the casing correctly fitted.
- Do not store objects around or on the boiler, and keep access clear at all times.
- Do not obstruct ventilation ducts, grilles or openings in the boiler room, room space or compartment that the appliance is installed in, or the passage of combustion and ventilation to the boiler.
- Do not turn off the boiler if it is to be left unattended in frosty weather.
- If it is known or suspected that a fault exists on the boiler then it **MUST NOT BE USED** until the fault has been corrected by a CORGI registered installer or in IE a competent person.
- Flammable materials must not be placed in close proximity to the appliance. Materials giving off flammable vapours must not be stored in the same room as the appliance.

In cases of repeated or continuous shutdown a CORGI registered installer or in IE a competent person should be called to investigate and rectify the condition causing this and carry out an operational test after each intervention on the device. Only the manufacturers original parts should be used for replacement.

## **Minimum Clearances**

### **Rear:**

1000mm or adequate space from the rear of the jacket to make the flue connections and access to the flue sample point, drain connection, flue and any safety or control devices.

### **Left Side:**

450mm.

### **Right Side:**

450mm.

### **Front:**

600mm; except, access doors may be closer, but not less than 200mm and 600mm must still be available for service across the width of the boiler.

### **Top:**

500mm.

## **To light the boiler (Refer to Frame 1)**

1. CHECK THAT THE ELECTRICITY SUPPLY TO THE BOILER IS OFF.
2. Set the burner on/off switch (A) to off.
3. Switch on the electricity supply to the boiler and check that all external controls, e.g. programmer, room thermostat etc. are on. Allow the boiler to carry out a self check.
4. Set the burner on/off switch (A) to ON.

The boiler will commence the ignition sequence, supplying heat to the system when required.

All CORGI Registered Installers carry a CORGI ID card, and have a registration number. Both should be recorded in your Log Book. You can check your installer by calling CORGI direct on 01256 372 300.

**CAUTION. To avoid the possibility of injury during the installation, servicing or cleaning of this appliance care should be taken when handling edges of sheet steel components.**

# 1 BOILER CONTROLS / DISPLAY (MASTER PANEL SHOWN)

## LEGEND

<b>A.</b> Burner switch	<b>E.</b> Mode button
<b>B.</b> Pressure gauge	<b>F.</b> Step button
<b>C.</b> Display	<b>G.</b> Store button
<b>D.</b> Reset button	<b>H.</b> + button (to increase values)
	<b>I.</b> - button (to decrease values)

SLAVE MODULE CONTROL PANEL

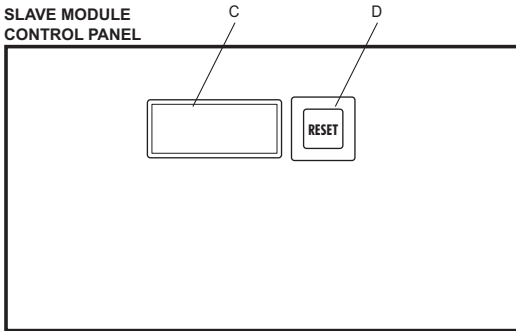

MASTER MODULE CONTROL PANEL

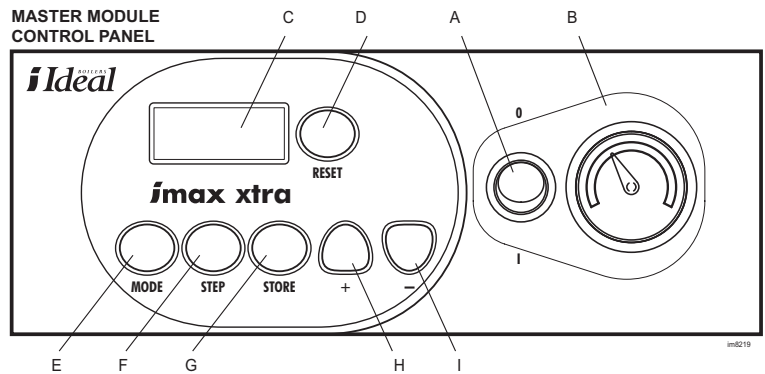

## Operation

Sequence	Boiler Status
A	DHW valve energised
0	Standby, no heat request
1	Pre-purge, post purge
2	Ignition
3	Burner on in CH mode
4	Burner on in DHW mode
5	Waiting for air pressure switch to open or close
6	Burner off because a set value has been reached
7	Pump overrun in CH mode
8	Pump overrun in DHW mode

In normal operation the display (C) shows the boiler status (see table above) and the water system flow temperature.

### Blocking Mode

The boiler will enter blocking mode under certain fault conditions. Whilst in blocking mode the burner is switched off. Once the fault conditions are clear the boiler will automatically reset itself. In blocking mode the display will alternate between showing a '9' in digit one, along with the flow temperature in digits 2, 3 and 4, e.g.

9 96

Followed by the blocking code 'bxx', e.g.

b 18

### Error Mode

In error mode the display will flash on and off with the error code shown, e.g.

E 36

The boiler will enter error mode under certain fault conditions. The unit will be inoperative until the fault is rectified. The reset button is used to reset the boiler control module after an error has occurred.

### Self Check and Anti-Seize Modes

After switching on the mains power or after a reset, the boiler performs a selfcheck, i.e. the DHW valve (if connected) is energised first for 15 seconds then the CH pump is switched on for a further 10 seconds. This cycle repeats itself every 24hrs, as long as no heat request is given in 24hrs.

### Burner on/off Switch

With the burner switch set to 'off' the boiler will not respond to a CH demand. However, it will respond to a DHW demand and the pump anti-seize and frost protection modes are still operational any one of which could cause the boiler to fire. Note. The burner switch is NOT a mains isolation switch.

### CH/DHW Systems

In standby mode pressing and holding the '+' button for 3 seconds turns the CH system on/off.

In standby mode pressing and holding the '-' button for 3 seconds turns the DHW system on/off.

## **To shut Down the Boiler**

### **1. For short periods**

Set the external controls to OFF. Wait 10 minutes and then isolate the mains supply to the boiler.

### **2. For longer periods**

Set the external controls to OFF. Wait 10 minutes and then isolate the mains supply to the boiler. For longer periods the entire system should be drained, including the domestic hot water supply.

## **To Relight the Boiler**

Refill the system if it has been drained, taking care to ensure no air is in the boiler or system.

Repeat the procedure detailed in 'To light the boiler'.

## **Frost Protection**

The **imax xtra** boiler has built into its control system the facility to protect the boiler only against freezing.

### **Note.**

This may not protect remote parts of the system, in which case a separate frost protection should be fitted.

## **Boiler Overheat**

Boiler overheating is detected by electrical sensors connected to the boiler control module. If the boiler overheats it will shut down and the display will show E18. Press the 'reset' button (D) and the boiler will relight. If the fault recurs turn off the boiler and consult a CORGI registered installer or in IE a competent person.

## **Condensate Drain**

The condensate drain must not be modified or blocked.

Blockage of the condensate drain, caused by debris or freezing, can cause automatic shutdown of the boiler or leakage from the condensate trap mounted on the bottom of the boiler.

If freezing is suspected and the pipe run is accessible an attempt may be made to free the obstruction by pouring hot water over the exposed pipe and clearing any blockage from the end of the pipe. If this fails to remedy the problem the assistance of a CORGI registered installer or in IE a competent person should be sought.

## **Escape of Gas**

Should a gas leak or fault be suspected contact your local gas supplier without delay.

Do NOT search for gas leaks with a naked flame.

## **Cleaning**

For normal cleaning simply dust with a dry cloth.

To remove stubborn marks and stains use a damp cloth and mild detergent.

DO NOT use abrasive cleaning materials.