

HunterDouglas

Installation • Operation • Care



Heritage® Hardwood Shutters
NewStyle® Hybrid Shutters

CONTENTS

Getting Started

Installation Overview	1
Unpacking	1
Tools and Materials Needed	1
Fasteners	2

Frame Assembly

Assemble the Frame	3
--------------------------	---

Installation

Standard Panel Systems	4
Hang Strip Installation	7
Bi-Fold Track Systems	10
Bypass Track Systems	16
French Door Shutters	23
Corner Windows	26
Bay Windows	29
Unframed Specialty Shapes	33
Framed Specialty Shapes	37
Arch Top and Angle Top Panels	40
Finish Work.....	43

Operation and Care

Operation	45
Care.....	45

Troubleshooting

Louver and Louver Pin Replacement.....	46
--	----

If you have any questions about installation, application, operation, or care and cleaning, Hunter Douglas Customer Service Shutter Specialists are available at 1-888-727-5230 toll-free. Shutter Specialists are available from 6:00 a.m. to 5:00 p.m. Mountain Standard Time, Monday through Friday.

Hunter Douglas shutters are built using the highest quality materials. When properly installed, these shutters will provide a lifetime of beauty and performance.

IMPORTANT: These installation instructions are intended for professional installers who have been certified after attending Hunter Douglas shutter training.

Installation Overview

Panel shutters come in many configurations — individually hinged, bi-fold panels, with and without T-posts, track systems comprised of from one to many panels, and with a variety of frames for inside or outside mounting.

Whatever the configuration, installation procedures are basically the same. The frame is assembled and fastened to the window at two points. Then the shutter panels are individually installed and racked, during which time frame attachment is completed. Magnet mounting, caulking, and other finish work complete the installation.

Unpacking

Carefully unpack the shutters. The package will include:

- Shutter panels
- Disassembled frames
- Miscellaneous hardware

Tools and Materials Needed

Tools

- Flat blade, Phillips, and Robertson #1 screwdrivers
- Measuring tape
- Power drill and drill bits
- Pencil
- Finish nailer
- Level
- Rubber mallet
- Awl





Materials

- Canvas drop cloth large enough for unpacking and pre-drilling
- Clean fabric cloth and a mild cleaning spray solution
- Shim materials
- Finishing supplies (caulk, fill-sticks, etc.)
- An extra supply of assorted Hoffman keys

GETTING STARTED

Fasteners

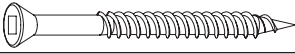
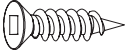
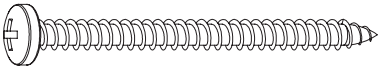
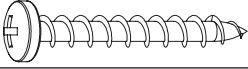
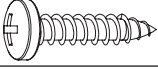
Screws of varying lengths and types are required to install shutters. The chart below shows the standard fasteners, what each is used for, and the driver needed to secure them. Other types of installation screws may be needed if mounting into concrete, metal, or similar surfaces.

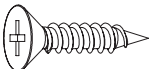
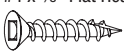
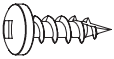
<p>#8 x 3½" Installation Screw — #1 Robertson</p> 	<p>Attaches L11 L-frame with two build-outs or L35 3¾" L-frame</p>
<p>#8 x 3" Installation Screw — #1 Robertson</p> 	<p>Attaches L11 L-frame with one build-out or L-34 2¾" frame</p>
<p>#6 x 2¼" Installation Screw — #1 Robertson</p> 	<p>Attaches frame to mounting surface</p>
<p>#6 x 1⅝" Installation Screw — #1 Robertson</p> 	<p>Attaches sill frame to side frames and T-post</p>
<p>#6 x ⅝" Hinge Screw — #1 Robertson</p> 	<p>Attaches hinges, interpanel clips, and NewStyle® panel ramps</p>
<p>#8 x 2" Pan Head Screw — #2 Phillips</p> 	<p>Attaches bi-fold or bypass support bracket to opening</p>
<p>#8 x 1¼" Pan Head Screw — #2 Phillips</p> 	<p>Attaches bi-fold and bypass carrier hardware to panels</p>
<p>#8 x ¾" Pan Head Screw — #2 Phillips</p> 	<p>Attaches bi-fold or bypass track to frame or opening</p>
<p>#6 x ⅝" Pan Head Screw — #2 Phillips</p> 	<p>Attaches L-bracket to bi-fold or bypass frame and valance</p>
<p>#8 x 1" Flat Head Screw — #2 Phillips</p> 	<p>Attaches bi-fold pivot pin to panel</p>
<p>#8 x ¾" Flat Head Screw — #2 Phillips</p> 	<p>Attaches bi-fold pivot bracket to frame</p>
<p>#4 x ⅝" Flat Head Screw — #1 Robertson</p> 	<p>Attaches magnet strike plate</p>
<p>#6 Screw — #1 Robertson</p> 	<p>Attaches magnets</p>

CAUTION: Hunter Douglas recommends pre-drilling holes with wood shutters and especially hybrid shutters to avoid splitting the material with the fasteners.

Assemble the Frame

1. Lay out the frame sections on a soft surface. The frame sections are labeled left, right, top, and bottom. Match up the corners.
 - Special attention should always be paid to assure that the correct frame pieces are adjoined.



IMPORTANT: Correct matching of corners is especially critical for Heritage® shutters with the handcrafted, burnished technique because the burnishing is unique to each miter.

2. Use Hoffman keys (see image below) to connect the four corners of the frame. If necessary, tap the keys securely in place using a rubber mallet, or a standard hammer and wood block.

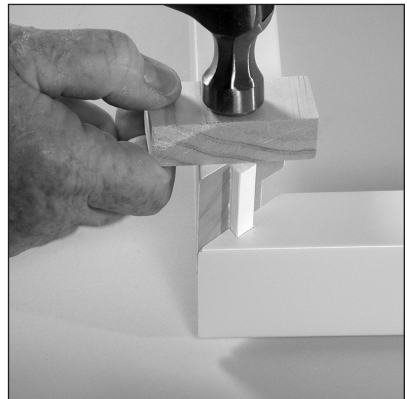
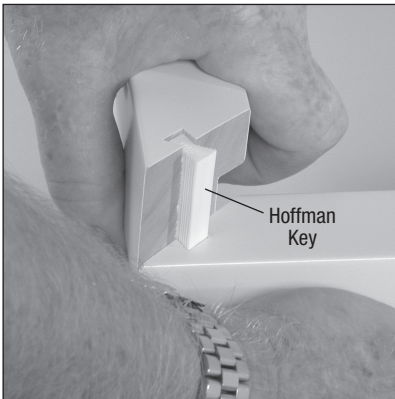

IMPORTANT: Be careful when moving assembled frames; support weight evenly to avoid placing torque on the joined corners.

- 3a. If build out or trim casing spacer was ordered, attach it to the assembled frame using either the fasteners that were sent or your nail gun.
- 3b. If one or more T-posts are used, mount them to the frame using **one** of the pre-drilled holes in the T-post and frame. The top of the T-posts are marked, and multiple T-posts are numbered, with number one starting at the left side of the frame and progressing right.
4. After the frame is assembled with the T-post(s) and before mounting in the window, it is recommended that you place the panels in the frame to make sure the T-post location is accurate. Adjust T-post location if necessary.
5. Secure the T-post(s) in place with the remaining screws.

IMPORTANT: For installations with multiple T-posts, it is recommended that you begin your racking at the center most section and work your way out to each end.

Standard Panel Systems



Step A. Install the Frame

1. Position the frame for mounting.

- **Outside (OM) Mount.** Center the frame over the opening. There should be a ¼" reveal on all four sides (or an equal reveal if a larger or smaller reveal was specified on the original order).
- **Inside (IM) Mount.** Center the frame in the opening. Insert temporary shims between the shutter frame and the window to hold the frame centered.

2. Attach the **side frames** within 3" of the top corners.



Step B. Mount the Panels

1. Place the panels into the frame by fitting the pin end of the hinges into the hinge barrels.
 - If necessary, tap up the hinge pins on one or more of the hinges in order to easily install the panels.
2. After the panels are installed, tap the pins down.
 - Be sure to use a tapping block to avoid damage to the panel or the pin.



3. Close the panels and check for proper alignment. If panels are misaligned, rack the shutters by grasping the frame at the bottom corners and move it from side to side until proper alignment is achieved.

NOTE: In the following procedures, after each fastener is placed, close the panels and check the alignment. If the alignment is lost, remove the fastener, re-align the panels, and then re-install the fastener.

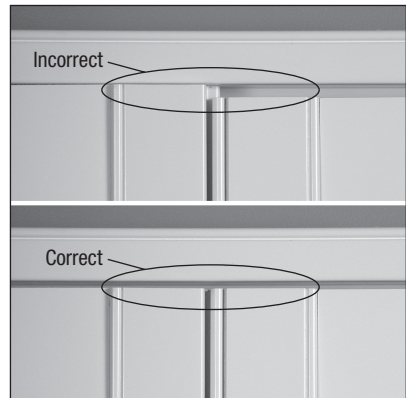

IMPORTANT: For installations with multiple T-posts, it is recommended that you begin your racking at the center most section and work your way out to each end.

NEWSTYLE® HYBRID SHUTTERS ONLY: Ramp caps are standard on the bottom of every panel on the non-hinged stile.

4. Hold the frame in the aligned position.

- **Outside (OM) Mount.** Use a fastener to secure the center of the bottom frame. Check alignment, and then secure the side frames within 3" of the bottom corners.

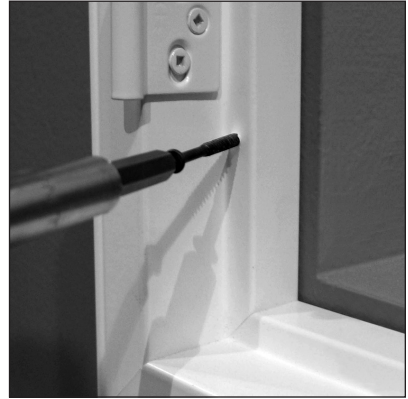

- **Inside (IM) Mount.** Use fasteners to secure the side frames within 3" of the bottom corners.



5. Use fasteners to secure the frame near each hinge.

IMPORTANT: Add fasteners at the bottom and top frame center. If using two or more panels, place a screw in the top and bottom frame, close to where the panels meet. (The screw should be slightly offset from the center so it will be less conspicuous.)

6. Perform any necessary finish work to complete the installation (see page 43).

Hang Strip Installation



Hang Strip Behind (HSB)

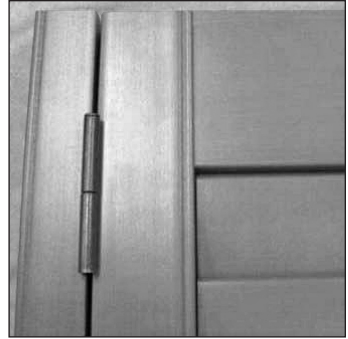

Hang Strip to the Side (HSS)

Hang Strip Behind (HSB) — Outside (OM) Mount

We suggest that light stop be installed on opening sides that do not have Hang strip. Generally, top and Bottom. Designed to minimize light gaps and provide a place to install the magnet base. If light stop is not ordered, a magnet spacer will be sent automatically.

Step A. Install the Frame

1. Attach the hinged hang strip first.

- The wide side of the hang strip should be against the mounting surface so that the hang strip projection is 1½".

NOTE: To hold and mount the panel with the hang strip simultaneously, attach the two by placing a rubber band around the two hinge barrels.

Step B. Mount the Panel(s)

1. Attach the panel(s) and check panel alignment with the hang strip.

- Adjust the hinges if necessary.
- If hinge adjustment is not sufficient, shims may be needed between the wall and the hang strip for final adjustment.

2. Align the other hang strip with the panel and attach it to the wall.

- The narrow side should be against the mounting surface so that the projection of the hang strip is 1¾".

NOTE: This will provide a light gap at the top and bottom of 1¾". If this light gap is not acceptable, you should order an FD frame or an L-frame.

Hang Strip Behind (HSB) — Inside (IM) Mount

Step A. Install the Frame

1. Attach both hang strips to the desired depth.

IMPORTANT: The panel(s) can be flush, but not inset inside the opening.

- If both hang strips will be hinged, they should be the same depth into the window.
- If only one side will be hinged, the non-hinged side should be placed ¼" closer to the panel than the hinged side so that the panel will engage the hang strip.

NOTE: To hold and mount the panel with the hang strip simultaneously, attach the two by placing a rubber band around the two hinge barrels.

2. Attach the light stop, top and bottom, at the desired locations.

Step B. Mount the Panel(s)

1. Attach the panel(s) and check panel alignment with the hang strips.

- Adjust the hinges if necessary.
- If hinge adjustment is not sufficient, shims may be needed between the wall and the hang strip for final adjustment.

Hang Strip to the Side (HSS) — Outside (OM) Mount Only

Hinges on One Side Only

Step A. Install the Frame

1. Attach the hang strip with the hinges first.

- Mark the desired location of the hang strips, centered over the opening.
- The wide side of both hang strips should be against the mounting surface so that their projection is 1 1/8".

NOTE: To hold and mount the panel with the hang strip simultaneously, attach the two by placing a rubber band around the two hinge barrels.

Step B. Mount the Panel(s)

1. Attach the panel(s) and check panel alignment with the hang strip.

- Adjust the hinges if necessary.

2. Align the other hang strip with the panel (a 3/32" gap between the hang strip and panel is ideal) and attach it to the wall.

Hang Strip to the Side (HSS) — Outside (OM) Mount Only

Hinges on Both Hang Strips**Step A. Install the Frame**

1. Attach the hang strips.
 - Mark the desired location of the hang strips, centered on the opening.
 - Attach each hanging strip with one screw above the top hinge.

NOTE: To hold and mount the panel with the hang strip simultaneously, attach the two by placing a rubber band around the two hinge barrels.

Step B. Mount the panels

1. Attach the panel(s) and check panel alignment with the hang strip.
 - Adjust the hinges if necessary.

Step C. Racking and Securing

1. Rack the panels to the desired location and mark the bottom placement of each hang strip.
2. Attach each hang strip with a screw above the bottom hinge.
 - Close the panels and adjust if necessary.
 - Attach all remaining screws, checking panel alignment after each screw is attached.
3. Perform any necessary finish work to complete the installation (see page 43).

Bi-Fold Track Systems



Step A. Assemble the Frame

- See “Assemble the Frame” on page 3. Note that most bi-fold track systems have three-sided frames.
- If build-out is required, mount it to the frame.
- If an aluminum track is attached to the top frame, remove it before proceeding.

Step B. Install the Frame

1. Position the frame for mounting.
 - **Outside (OM) Mount.** Center the frame over the opening. There should be a ¼" reveal on all three sides (or an equal reveal if a larger or smaller reveal was specified on the original order).
 - **Inside (IM) Mount.** Center the frame in the opening. Insert temporary shims under the side frames to hold the top frame piece against the jamb.

2. Attach the **top frame** first, starting within 3" of the **highest corner**.

IMPORTANT: Install all mounting screws into studs or window header.

3. Place a four foot level on the top frame and secure the second fastener in the top frame within 3" of the other corner. Be sure the top frame is level.
 - If necessary, shim inside mount shutters to level the top frame.



- Secure a fastener at the center of the top frame, making sure the top frame is level across its full width.

INCORRECT (Gap in Center)

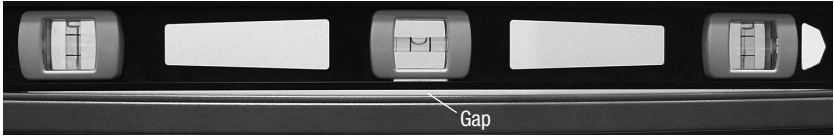

CORRECT (No Gap)

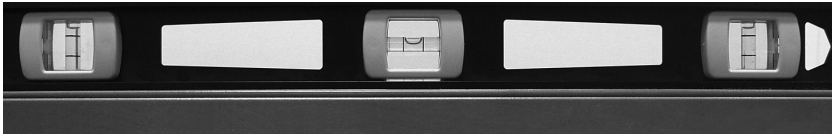

- Finish attaching the top frame by securing one screw at each stud, 16" to 24" apart, depending on the type of construction (no more than 30" between screws if mounting into header).
- Now secure **one pivot** side frame using a level for alignment.

IMPORTANT: If there are two pivot sides, still only secure **one** side. The other side will be secured after final adjustment.

Step C. Install the Frame Installation Support Brackets (Outside Mount Only)

Attach support brackets to wall studs (or header) and the top of the bi-fold frame. Brackets should be attached within 36" of each end and spaced no more than 36" apart.

- Using two screws, secure the first support to the wall stud (or header) nearest the corner.
- Now secure the next support to the wall stud (or header) nearest the opposite corner.
- Continue securing any additional supports.
- Attach the supports to the top frame.

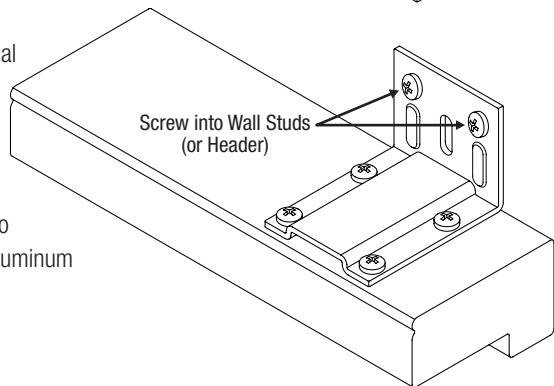
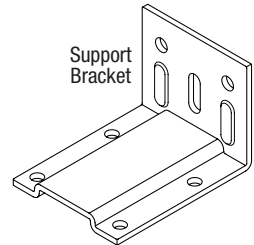

IMPORTANT: Be careful not to place screws in line with the aluminum track screw holes.

Step D. Attach the Aluminum Track to the Frame

1. Before attaching the track, make sure that you have inserted the correct number of carriers, top pivot brackets, and snubbers. For one way operation, one pivot pin and one snubber is required. For split operation, two pivot pins are required, **but no snubbers**.

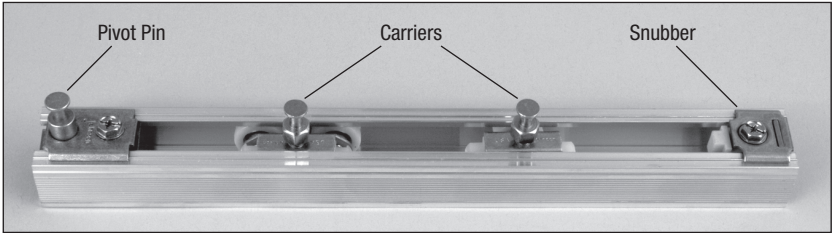

IMPORTANT: Carriers have three wheels. Each carrier can be loaded into the track with one wheel to the front or two wheels to the front.

2. After inserting the carriers, check that the carrier heights are the same as the pivot pin height (see photo below). Adjust as necessary.

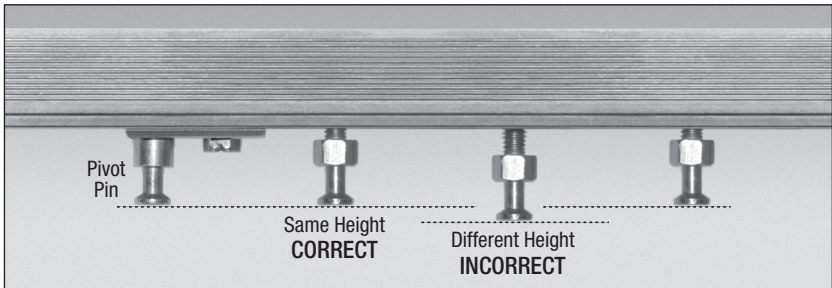
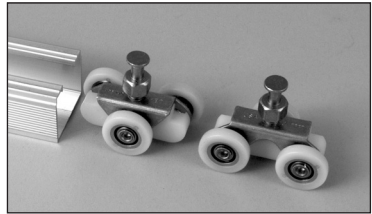

3. If the track arrived attached, use the same holes and re-attach the aluminum track to the top frame with the screws supplied. Be sure the holes line up correctly. Make sure there is a track screw within 3" of each end of the track.

➤ If the track did not arrive attached, attach it 1/32" in from the front edge of the frame.

Step E. Attach the Shutter Panels

1. Set the pivot pin(s) in the track so that the center of the pivot pin is $1\frac{5}{8}$ " from the side frame.

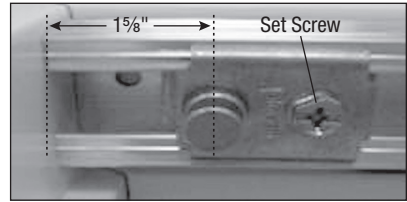

2. Mount the bottom pivot bracket(s) using the pre-drilled hole for the slotted screw.

- If the hole is not pre-drilled, drill a hole $1\frac{5}{16}$ " ($1\frac{13}{16}$ " with the bottom track) from the bottom of the side frame and 1" from the light stop.
- Install the bottom pivot bracket.

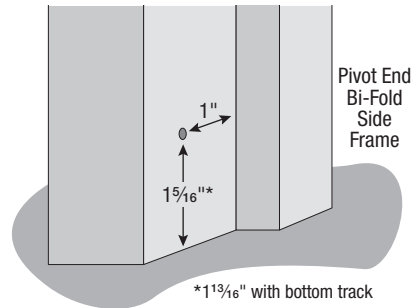

3. Mount the first panel per side into the bottom pivot pin receiver first and then the top pivot pin receiver.
 - When both sides have pivot pin receivers, install the first panel on the other side as well.
 - If adjustment is necessary, mark the correct position of the top and/or bottom receiver(s). Use a $\frac{5}{16}$ " socket to adjust the bottom receiver if it is too tight for the wrench.

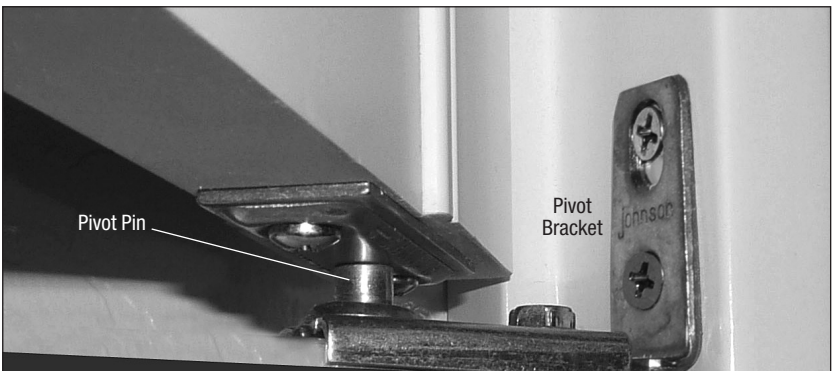

4. Insert the remaining shutter panels into the hinges and receivers.
 - Using labels and hinges for correct panel positioning, lock all panels into place by rotating the lever on the receiver.
 - If panels are uneven make any minor adjustments with the carrier bolts using the wrench provided.

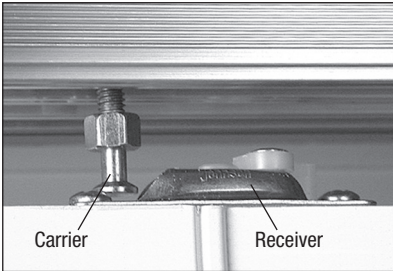

Step F. Finalize the Adjustment

1. **For one-way operation:** Secure the snubber for proper tension. Then locate the unsecured frame to its adjacent panel and secure it.
2. **For two-way operation:** Hold the loose side frame so the center split panels come together. Then adjust the carriers if necessary. Finally, mark the position of the side frame and secure it. (If a bottom track is ordered, place the aluminum track before attaching the side frame.)

Step G. Install the Optional Bottom Track

1. Place the bottom track directly under the bottom pivot bracket. If both sides have pivots, repeat on the opposite side.
2. Secure the aluminum track to the floor across the full opening width.
3. Attach the finish quarter round strips to both sides of the track. The quarter rounds must be notched on site to clear the bottom pivot bracket.

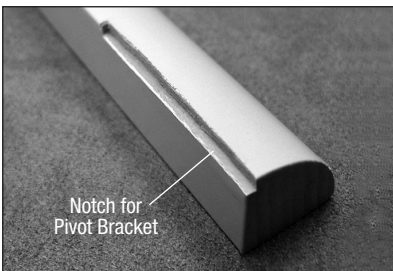

Step H. Attach the Optional Valance

IMPORTANT: Two valances are available, standard (3½") and decorative (5"), and both are mounted in a similar manner.

1. There should be approximately ¼" space between the bottom of the valance and the top of the panels. A simple way to achieve this clearance is to place two stacked ⅛" wood slat shims onto the open panels in several places to support the valance during installation.
2. **Attachment Method 1:** Once the proper valance location is determined to cover the hardware, secure the valance in place with finishing nails through the face into the top frame. If a nail gun is not available, use a tack hammer and finishing nails.

IMPORTANT: With NewStyle® shutters, when using a tack hammer and nail set to secure the finishing nails, pre-drill through the valance and frame first.

3. **Attachment Method 2:** If space allows, use L-brackets and screws, as shown.
4. Perform any necessary finish work to complete the installation (see page 44).

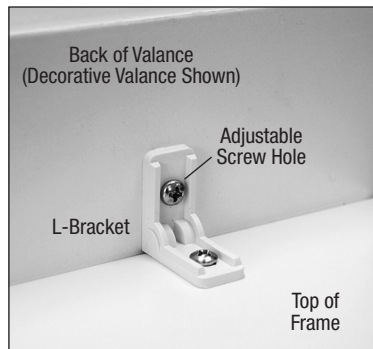

Bypass Track Systems



Step A. Assemble the Frame

- See “Assemble the Frame” on page 3. Note that most bypass track systems have three-sided frames.
- If aluminum tracks are attached to the top frame, remove them before proceeding.

Step B. Install the Frame

1. Position the frame for mounting.
 - **Outside (OM) Mount.** Center the frame over the opening. There should be a $\frac{1}{4}$ " reveal on all three sides (or an equal reveal if a larger or smaller reveal was specified on the original order).
 - **Inside (IM) Mount.** Center the frame in the opening. Insert temporary shims under the side frames to hold the top frame piece against the jamb.
2. Attach the **top frame** first, starting within 3" of the **highest corner**.

IMPORTANT: Install all mounting screws into studs or window header.



- Place a four foot level on the top frame and secure the second fastener in the top frame within 3" of the other corner. Be sure the top frame is level.
- If necessary, shim inside mount shutters to level the top frame.
- Secure a fastener at the center of the top frame, making sure the top frame is level across its full width.

INCORRECT (Gap in Center)

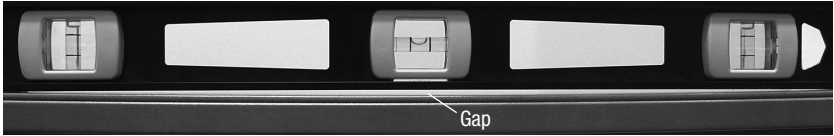

CORRECT (No Gap)

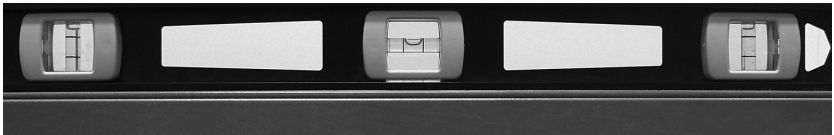

- Finish attaching the top frame by securing one screw at each stud, 16" to 24" apart, depending on the type of construction (no more than 30" between screws if mounting into header).

Step C. Install the Frame Installation Support Brackets (Outside Mount Only)

Attach support brackets to wall studs (or header) and the top of the bypass frame. Brackets should be attached within 36" of each end and spaced no more than 36" apart.

- Using two screws, secure the first support to the wall stud (or header) nearest the corner.
- Now secure the next support to the wall stud (or header) nearest the opposite corner.
- Continue securing any additional supports.
- Attach the supports to the top frame.

IMPORTANT: Be careful not to place screws in line with the aluminum track screw holes.

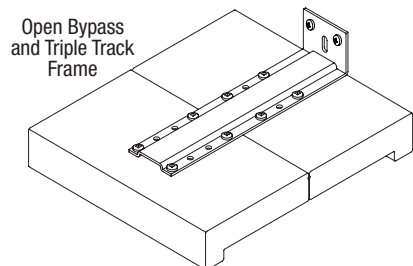
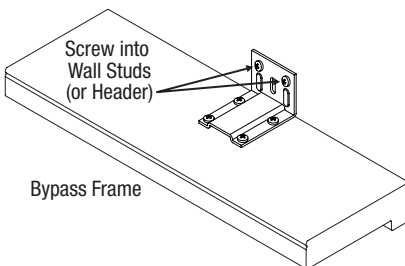

Step D. Attach the Track to the Frame

1. Before attaching the tracks, make sure that you have inserted the correct number of carriers (two carriers for each panel) into each track.

IMPORTANT: Carriers have three wheels. Each carrier can be loaded into the track with one wheel to the front or two wheels to the front.

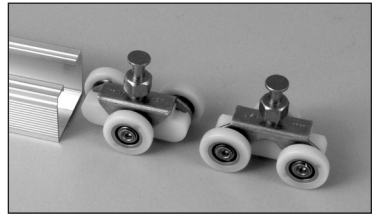

2. Check that the carrier heights are consistent from carrier to carrier (see photo below). Adjust as necessary.

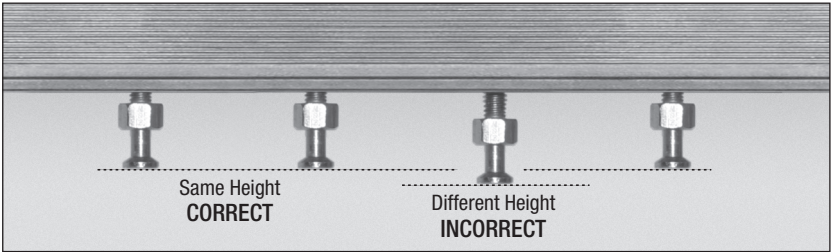

3. If the tracks arrived attached, use the same holes and re-attach the aluminum tracks to the top frame with the screws supplied. Be sure the holes line up correctly. If the tracks did **not** arrive attached:
 - **Standard Bypass Systems:** Attach one track against the light stop and the other track flush with the front edge of the top frame.
 - **Open Bypass Systems:** Attach one track against the front light stop and one track against the back light stop.
 - **Triple Track Systems:** Attach the front and back tracks against the front and back light stops. Attach the middle track centered between the front and back tracks.

Step E. Attach Privacy Strips (Triple Track and Open Bypass Only)

1. Remove the liner from the adhesive on the privacy strips.
2. Position the privacy strips on the panels as needed for the opening (see illustrations).

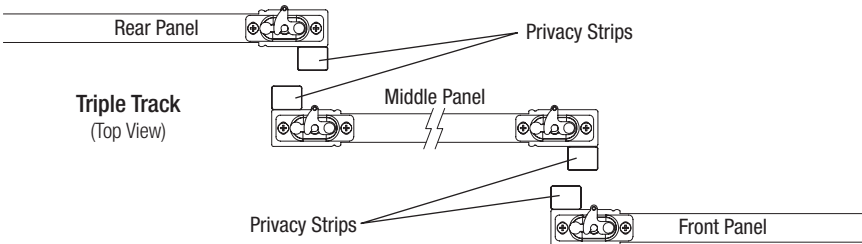

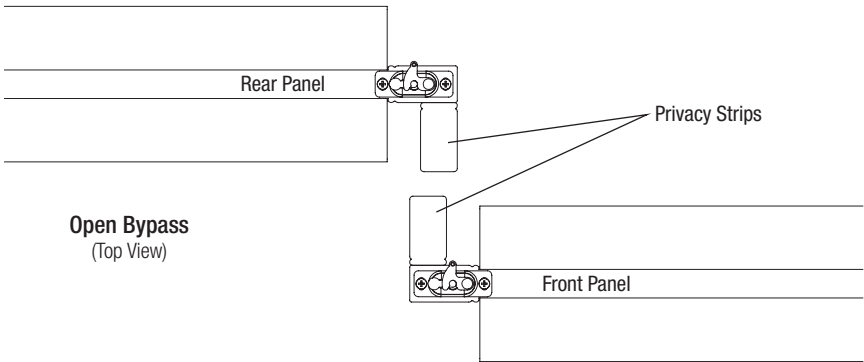

3. Press each privacy strip firmly against the stile. Be sure to apply pressure at several places along the full length of the privacy strips. Secure each strip with two screws (provided).

Step F. Attach the Shutter Panels

1. Mount the panels onto the carriers and lock them in place by rotating the lever on the receiver. Continue until all panels are secure.

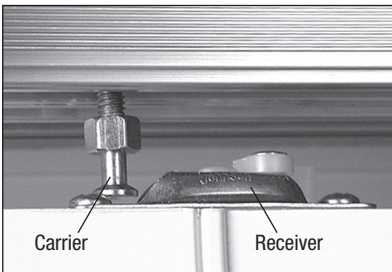

2. Check that floor clearance is acceptable. If not, lower or raise the panel by adjusting both of its carrier bolts the same amount. Use the wrench provided.
3. If panels are to be paired, attach inter-panel clips (if not already attached) and snap the panels together.

Step G. Check for Alignment

1. If carriers were not adjusted previously, adjust the carrier bolts so that all panels are at the same height.
2. Open the louvers of the back panel where panels overlap and slide the front panel until the stile is adjacent to or touching the open louvers. If gaps appear between the front panel stile and the open louvers at the top or bottom, adjust the carrier bolts in pairs: the two middle carriers or the left and right end carriers.

NOTE: If panels are married, carriers should always be adjusted up.



Step H. Attach Side Frames

1. Finalize alignment by locating the side frames to their adjacent panel and secure to the wall with fasteners.

Step I. Install the Optional Floor Guide(s)

1. Attach one or more floor guides at the appropriate location(s) using the proper fasteners. Typically, one guide is required wherever two panels overlap.
2. Turn the center guide post to its widest position to insure proper panel spacing.



IMPORTANT: Use caution when operating the panels to avoid panel damage where the guides contact the stiles.

Step J. Install the Optional Bottom Tracks**Standard Bypass Systems (Two Tracks)**

1. Place the rear track $\frac{1}{4}$ " from the light stop of the side frame and secure to the floor.
2. Place the center wood spacer against the rear track holding it in place by securing the front track to the floor.
3. Attach the finish quarter round strips to the front of the front track and the back of the rear track.

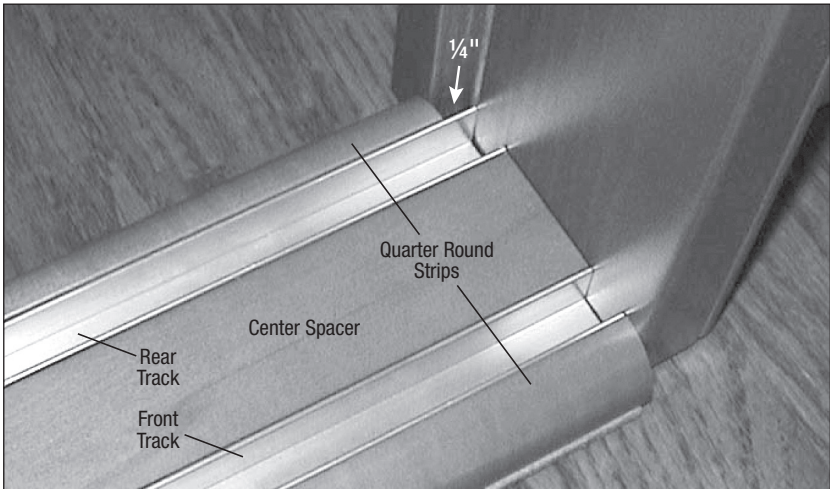
**Open Bypass Systems (Two Tracks)**

1. Place the rear track $\frac{1}{4}$ " from the rear light stop of the side frame and secure to the floor.
2. Place the front track $\frac{1}{4}$ " from the front light stop of the side frame and secure to the floor.
3. Attach the finish quarter round strips to the front and back of the each track.

Triple Bypass Systems (Three Tracks)

1. Place the rear track $\frac{1}{4}$ " from the rear light stop of the side frame and secure to the floor.
2. Place the front track $\frac{1}{4}$ " from the front light stop of the side frame and secure to the floor.
3. Center the middle track between the front and rear tracks and secure to the floor.
4. Attach the finish quarter round strips to the front and back of the each track.

Step K. Attach the Optional Valance

IMPORTANT: Two valances are available, standard (3½") and decorative (5").

1. Position the valance to cover the hardware.
2. **Attachment Method 1:** Secure the valance in place with finishing nails through the face into the top frame. If a nail gun is not available, use a tack hammer and finishing nails.

IMPORTANT: With NewStyle® shutters, when using a tack hammer and nail set to secure the finishing nails, pre-drill through the valance and frame first.

3. **Attachment Method 2 (decorative valance only):** If space allows, use L-brackets and screws, as shown.
4. Perform any necessary finish work to complete the installation (see page 44).

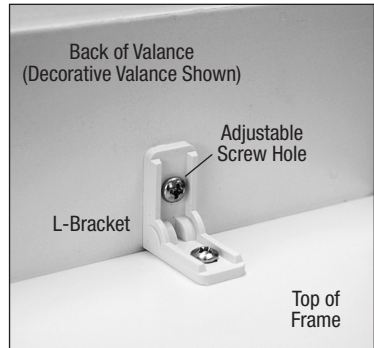

French Door Shutters

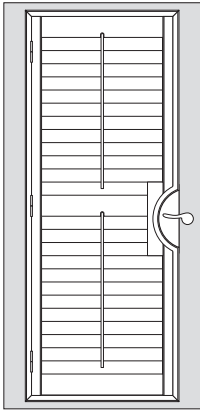

Framed French Door Panel with 3½" Cut-Out (FDC)

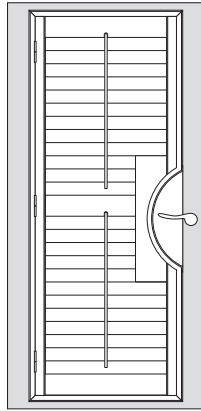

Framed French Door Panel with 5" Cut-Out (FDC)

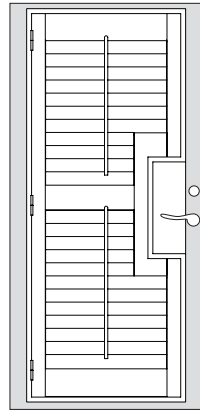

Framed French Door Panel with rectangular Cut-Out (FDC)

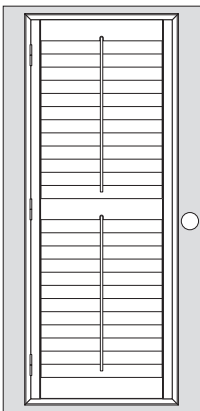

French Door Panel with L-Frame

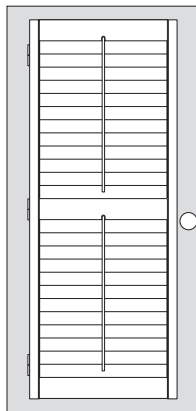

French Door Panel with Four-Sided Hang Strip Behind (FD Frame)

Step A. Assemble the Frame

■ See "Assemble the Frame" on page 3.

Step B. Install the Frame

IMPORTANT: Angle or toe the screws on French door installations to make sure you do not break the glass. In addition, screw placement must not interfere with the door handle hardware and lock mechanisms.

1. Pre-drill for all fasteners approximately 1" above each hinge and at the same heights on the opposite side frame. Use a long 3/32" drill bit. (Fasteners on the top and bottom may also be needed for final adjustment.)

- It is highly recommended that you pre-drill from the back to the front of the frame to get the greatest angle possible. (If possible, use a piece of scrap wood on the face to limit splitting of the face.)

2. Secure the side frame next to the knob.

- Center the frame on the opening.
- Place the first screw by the door knob, second screw near the top, and third screw near the bottom.
- Make sure that the overlap (if any) is the same in the middle, top, and bottom. This will assure that the vertical line of the door will match the vertical line of the shutter.

IMPORTANT: Place the cut-out in the appropriate location to fit around the door hardware.

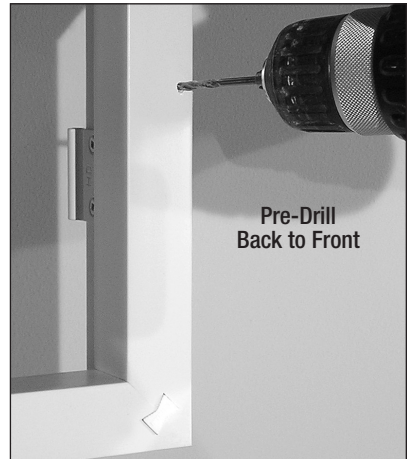

Step C. Mount the Panel

1. Carefully support the frame while inserting the panel into the hinges.

- Use supports under the hinged side of the frame to support the weight of the panel.
- If necessary, tap up the hinge pins on one or more of the hinges in order to easily install the panels.

2. After the panels are installed, tap the pins down.

- Be sure to use a tapping block to avoid damage to the panel or the pin.

Step D. Racking and Securing

1. Close the panel and check for proper alignment.

- If the panel is misaligned, grasp the hinged side of the frame and rack up and down until proper alignment is achieved.
- Open the panel and insert a screw above the top hinge in the pre-drilled hole.
- Close the panel and check alignment. If misaligned, remove the screw and re-align.

2. Secure the bottom of the side frame through the pre-drilled holes.
3. Close the panel and adjust the center of the hinged side frame so that the gap between the other side frame and the panel is consistent. Mark the proper position of the frame, open the panel, and attach the frame through the pre-drilled hole.
4. Attach all remaining fasteners.

IMPORTANT: With each fastener that is placed, close the panel and check the alignment. If the alignment is lost, remove the fastener, re-align the panel, and re-install the fastener.

Step E. Magnet Mounting — French Door Cut-Out (FDC) and L-frame

- Magnets may be pre-installed, if not see “No-Measure Magnet Mounting” on page 43.

IMPORTANT: A minimum of two magnets are required on all French Door installations. An additional magnet may be needed at the center of the panel.

Step F. Magnet Mounting — French Door with Hang Strip Frame (FD Frame)

- Magnets for French door shutters with hang strip frame will not be pre-installed.

IMPORTANT: A minimum of two magnets are required on all French door installations.

1. Mark the top and bottom frame where the rail and the stile meet, as shown below.
2. Using the flat head screw provided, position the strike plate flush with the edge of shutter rail and tight against the stile. Make sure the head of the screw is flush with or below the surface of the strike plate.
3. Mount magnets to the top and bottom of the hang strip frame.

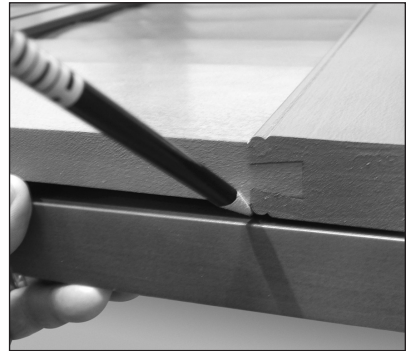

- Position the magnet base so that the edge of the magnet is aligned with your pencil mark, on the hinge side of the mark.
 - Attach the magnets using the pan head screws provided. Place the screw in the center of the slot to allow the magnet to move if adjustment is required.
4. A third magnet may be needed at the center of the panel.
 5. Perform any necessary finish work to complete the installation (see page 44).

Corner Windows



Step A. Assemble the Frames

- See "Assemble the Frame" on page 3.

After the two frames are assembled, attach them together. Use a hang strip to join the corner L-frames.

1. Attach a hang strip $\frac{1}{32}$ " in from the surface of the corner L-frame for the left opening.
 - Use three $1\frac{1}{8}$ " screws. Start the screw through the L-frame and into the hang strip.

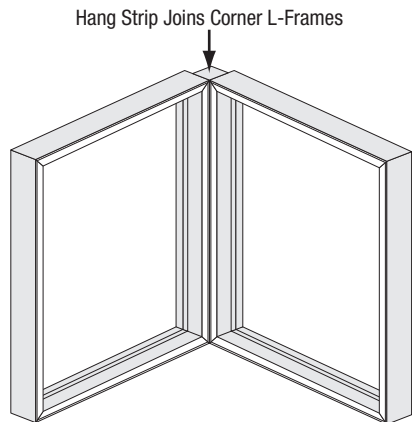
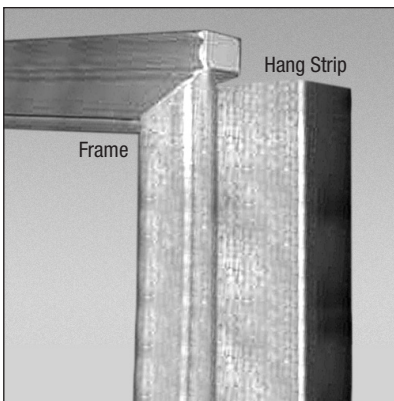

2. Attach the corner L-frame of the right frame to the hang strip as you did in Step 1 for the left frame.
 - Butt the corner L-frame for the right opening to the L-frame of the left opening.
 - For Z/L frame combinations, file the profile of the Z-frame edge where the Z-frames meet on the top and bottom to ensure a tight fit of the L-frames.
 - For applications with bottom and/or top sill frame, trim the corners of the sill frame(s) so that the left and right frames will abut properly.

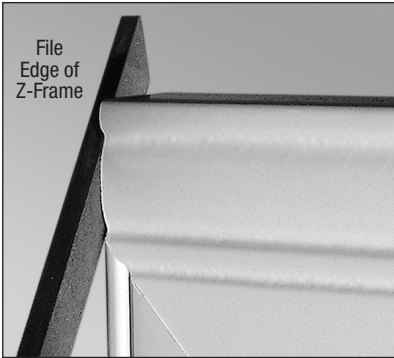

IMPORTANT: Make sure that the tops are flush, and the bead edge of the butting L-frames are aligned properly and **do not** overlap.

Step B. Install Frames (Inside or Outside Mount)

1. Center the attached frames (L-frame and Z/L frame combinations) over or into the openings and even out your reveal, using shims as necessary.
2. Secure the top and bottom inside corners of the left and right frame.

Step C. Mount the Left Corner Panel(s)

1. Support the left side of the frame with support blocks (OM) or shims (IM) before inserting the panel(s).



2. Place the panel(s) into the left frame by fitting the pin end of the hinges into the hinge barrels.
 - If necessary, tap up the hinge pins on one or more of the hinges in order to easily install the panels.
3. After the panels are installed, tap the pins down.
 - Be sure to use a tapping block to avoid damage to the panel or the pin.

Step D. Rack and Secure the Left Corner Panel(s)

1. After mounting the panel(s), close the panel(s) and check for proper alignment.
 - If misaligned, grasp the left side of the left frame at the top and bottom, and move the frame up and down until proper alignment is achieved.
 - Mark the position of the frame on the wall and open the panel(s).



2. Attach the frame at the left-side top corner, making sure the frame lines up with your mark.
3. Close the panel(s) and check alignment.
4. Secure the balance of the frame. There should be one screw within 3" of each corner and no more than 30" between fasteners.

IMPORTANT: With each fastener that is placed, close the panels and check the alignment. If the alignment is lost, go back to the fastener, remove, re-align, and re-install.

Step E. Mount the Right Corner Panel(s)

- Repeat Step C for the right panel(s).

Step F. Rack and Secure the Right Corner Panel(s)

- Repeat Step D for the right panel(s).
- Perform any necessary finish work to complete the installation (see page 43).

Bay Windows



Step A. Assemble the Frames

- See "Assemble the Frame" on page 3.

Step B. Install the Middle Bay Frame (Inside or Outside Mount)

1. Center the frame of the middle bay over (OM) or into (IM) the opening.
 - For Z/L frame combinations, file the profile of the Z-frame edge where the Z-frames meet on the top and bottom to ensure a tight fit of the L-frames. After filing, touch up the material with matching paint or stain.
 - For applications with bottom and/or top sill frame, trim the corners of the sill frame(s) so that the frames will abut properly.

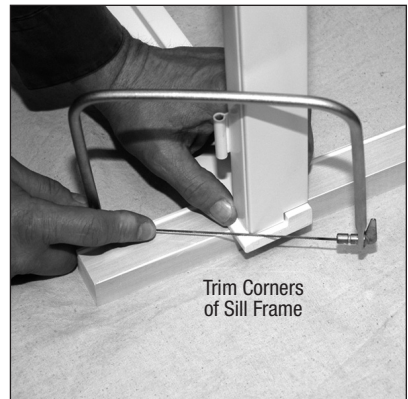
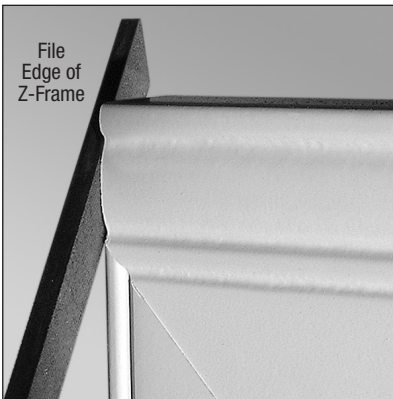

2. Attach the top of the middle frame within 3" of each corner.
3. Place the left and right bay frames in the opening to check if the middle bay frame needs to be shimmed out. Shim if needed.



Step C. Mount the Middle Bay Panel(s)

1. Place the panel(s) into the middle bay frame by fitting the pin end of the hinges into the hinge barrels.
 - If necessary, tap up the hinge pins on one or more of the hinges in order to easily install the panels.
2. After the panels are installed, tap the pins down.
 - Be sure to use a tapping block to avoid damage to the panel or the pin.

Step D. Rack and Secure the Middle Bay Panel(s)

1. After mounting the panel(s), close the panel(s) and check for proper alignment.
 - If misaligned, grasp the bottom frame and move it side-to-side until proper alignment is achieved.
 - Mark the position of the frame on the wall and open the panel(s). Marking the position is particularly important with larger shutters.
2. Attach the frame to the wall within 3" of the bottom corner, making sure the frame lines up with your mark.
3. Close the panel(s) and check alignment.
4. Secure the balance of the frame. There should be one screw within 3" of each corner and no more than 30" between fasteners.

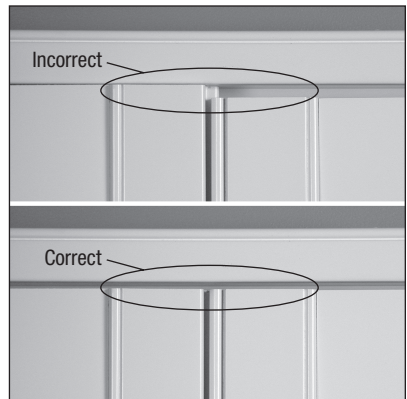

IMPORTANT: With each fastener that is placed, close the panels and check the alignment. If the alignment is lost, go back to the fastener, remove, re-align, and re-install.

Step E. Install the Left Bay Frame

1. Align the right side of the left bay with the left side of the middle bay frame.
 - For Z/L frame combinations or sill frames, file or trim the right side of the frame as described in Step B.

IMPORTANT: Make sure that the tops are flush, and the bead edge of the butting L-frames are aligned properly and **do not** overlap.

2. Attach the top and bottom of the frame within 3" of the right corners.

Step F. Mount the Left Bay Panel(s)

1. Support the left side of the frame with support blocks (OM) or shims (IM) before inserting the panel(s).



2. Place the panel(s) into the left frame by fitting the pin end of the hinges into the hinge barrels.
 - If necessary, tap up the hinge pins on one or more of the hinges in order to easily install the panels.
3. After the panels are installed, tap the pins down.
 - Be sure to use a tapping block to avoid damage to the panel or the pin.

Step G. Rack and Secure the Left Bay Panel(s)

1. After mounting the panel(s), close the panel(s) and check for proper alignment.
 - If misaligned, grasp the left side of the left frame at the top and bottom, and move the frame up and down until proper alignment is achieved.
 - Mark the position of the frame on the wall and open the panel(s).
2. Attach the frame at the left-side top corner, making sure the frame lines up with your mark.
3. Close the panel(s) and check alignment.
4. Secure the balance of the frame. There should be one screw within 3" of each corner.

IMPORTANT: With each fastener that is placed, close the panel(s) and check the alignment. If the alignment is lost, go back to the fastener, remove, re-align, and re-install.

Step H. Install the Right Bay Frame

- Repeat Step E for the right frame.

Step I. Mount the Right Bay Panel(s)

- Repeat Step F for the right panel(s).

Step J. Rack and Secure the Right Bay Panel(s)

- Repeat Step G for the right panel(s).

NOTE: A center screw may be needed between the L-frame sides to maintain an even bead between the L-frames from top to bottom. Remember to always pre-drill to avoid splitting the wood or hybrid material.

- Perform any necessary finish work to complete the installation (see page 43).

Unframed Specialty Shapes



Stand-Alone Unframed Specialty Shapes

Step A. Install the Specialty

IMPORTANT: Unframed specialty shapes are recommended as outside (OM) mounts. Inside (IM) mounting can result in light gaps that may need to be concealed. Caulk and weather strip are two possible ways to conceal the light gaps.

Unframed specialty shapes may be attached with button catches or with screws or finishing nails.

Option 1: Button Catch Installation

Button catches consist of a button that attaches to the rail around the shape and a catch that attaches to the wall or window casement.

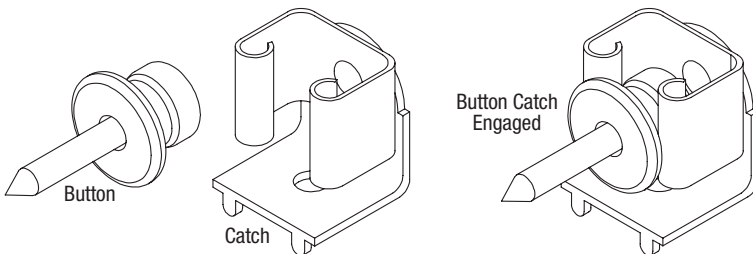

1. Mount catches 3" from where the bottom corners of the shape will be located.
 - For inside flush mounts, the front edge of the catch should be at least 1 1/8" back from the edge of the opening.
 - Refer to the illustration on the following page.

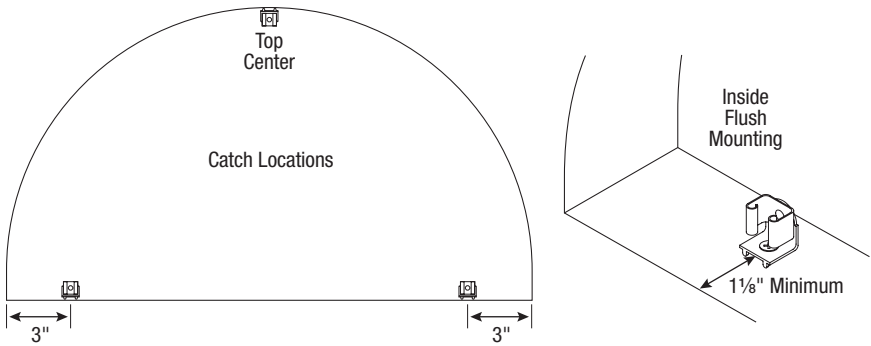

2. Mount a catch where the center top of the shape will be located.
 - For larger shapes, additional catches can be mounted every 18".
3. Place buttons in all the installed catches.
4. Insert the specialty shape into the opening. Push firmly at each catch location to create an indentation in the shape's rail.
5. Remove the buttons from the catches and screw them into the rail at each indentation.
6. Insert the specialty shape back into the opening and push until all button catches are snapped in place.

Option 2: Installation with Screws or Finishing Nails

1. If using screws, pre-drill four holes in the bottom of the rail, as well as at the top center of arches (12:00) or at the angles of angled shapes. Drill through the inside of the rail, being careful not to interfere with the louver pin holes.



2. If using a finishing nail gun, nail through the groove next to the bead in the rail.

3. Center the shape over the opening.
 - To help center arches, first determine the location of the top center (12:00) of the arch opening and place a pencil mark on the wall. This should be at least 1 $\frac{3}{8}$ " to 2 $\frac{1}{8}$ " above the opening, depending on the overlap desired.
4. Secure the rail with screws or finishing nails.

IMPORTANT: If using screws, be careful not to distort the shape of the rail. Do not overtighten the screws.
5. Check for light gaps and place additional fasteners, if needed.

Step B. Install the Louvers

1. From the glass side of the shape, insert the narrow end of the louver into the hub. Depress the spring and align the outer end of the louver with the louver pin hole. The louver should now be in place.
2. Insert the remaining louvers in the same manner.
3. Perform any necessary finish work to complete the installation (see page 44).



Unframed Specialty Shapes Over Shutter in a Continuous Opening

Step A. Install the Specialty

1. First, install the standard panel shutter using the installation instructions for standard panel systems. (See pages 3 through 6.)
2. Attach the bottom of the shape's rail to the top frame of the shutter.
 - Rest the base of the shape's rail on the top frame of the bottom shutter and check the alignment of the shape.
 - Pre-drill through the top frame of the bottom shutter into the bottom rail of the shape (or vice-versa). Drill in a minimum of four places.
 - Using screws of appropriate length, attach the shape's bottom rail to the frame through the pre-drilled holes.

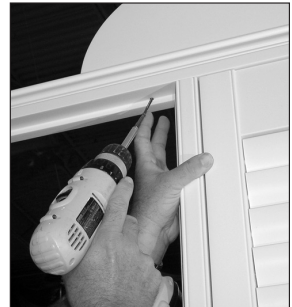

IMPORTANT: If mounting over a Z-frame, a finish nailer is recommended.

3. Secure the top portion of the shape's rail. Place fasteners at the top center of arches (12:00) or at the angles of angled shapes.
 - If using screws, pre-drill holes. Drill through the inside of the rail, being careful not to interfere with the louver pin holes.
 - If using a finishing nail gun, nail through the groove next to the bead in the rail.



IMPORTANT: If using screws, be careful not to distort the shape of the rail. Do not overtighten the screws.

4. Check for light gaps and place additional fasteners, if needed.
5. Other methods of installation may include brackets, wood blocks, or catches.

Step B. Install the Louvers

1. From the glass side of the shape, insert the narrow end of the louver into the hub. Depress the spring and align the outer end of the louver with the louver pin hole. The louver should now be in place.
2. Insert all of the remaining louvers in the same manner.
3. Perform any necessary finish work to complete the installation (see page 44).



Unframed Horizontal Louver Specialty Shapes

1. Unframed horizontal louver specialty shapes may be installed with finish nails or catches.
2. If using catches, be certain to place enough catches to ensure the specialty shape is safely and securely in place after installation.
3. Perform any necessary finish work to complete the installation (see page 44).

Framed Specialty Shapes



Stand-Alone Framed Specialty Shapes

Step A. Install the Specialty

1. Position the frame for mounting.
 - **Outside (OM) Mount.** Center the frame over the opening so that there is an equal reveal inside the shape.
 - **Inside (IM) Mount.** Center the frame in the opening. Insert temporary shims between the shutter frame and the window to hold the frame centered.
2. Attach the frame as you would a standard panel shutter. Place fasteners within 3" of all corners and angles, as well as at the top center of arches (12:00).

IMPORTANT: When placing screws, be careful not to distort the shape of the frame. Do not overtighten the screws.

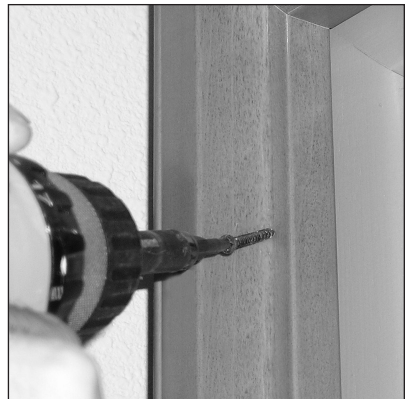

Step B. Mount the Panel (Without Louvers)

1. Place the panel into the frame by fitting the pin end of the hinges into the hinge barrels.
2. Close the panel and check for proper alignment. If misaligned, adjust the frame or hinge position.

Step C. Install the Louvers

1. From the glass side of the shape, insert the narrow end of the louver into the hub. Depress the spring and align the outer end of the louver with the louver pin hole. The louver should now be in place.
2. Insert all of the remaining louvers in the same manner.
3. Perform any necessary finish work to complete the installation (see page 44).

Framed Specialty Shapes Over Shutter in a Continuous Opening

Step A. Install the Specialty

1. First, install the standard panel shutter using the installation instructions for standard panel systems. (See pages 3 through 6.)
2. Attach the bottom of the shape's rail to the top frame of the shutter.
 - Rest the base of the shape's rail on the top frame of the bottom shutter and check the alignment of the shape.
 - Pre-drill through the top frame of the bottom shutter into the bottom rail of the shape (or vice-versa). Drill in a minimum of four places.
 - Using screws of appropriate length, attach the shape's bottom rail to the frame through the pre-drilled holes.

IMPORTANT: If mounting over a Z-frame, a finish nailer is recommended.

3. Secure the top portion of the shape's rail. Place fasteners within 3" of all corners and angles, as well as at the top center of arches (12:00).

IMPORTANT: When placing screws, be careful not to distort the shape of the frame. Do not overtighten the screws.

Step B. Mount the Panel (Without Louvers)

1. Place the panel into the frame by fitting the pin end of the hinges into the hinge barrels.
2. Close the panel and check for proper alignment. If misaligned, adjust the frame or hinge position.

Step C. Install the Louvers

1. From the glass side of the shape, insert the narrow end of the louver into the hub. Depress the spring and align the outer end of the louver with the louver pin hole. The louver should now be in place.
2. Insert all of the remaining louvers in the same manner.
3. Perform any necessary finish work to complete the installation (see page 44).

Framed Horizontal Louver Specialty Shapes

1. Framed horizontal louver specialty shapes (T1-T4) cannot be hinged. Catches will be sent, in lieu of hinges, for these specialty shapes.
2. Be certain to place enough catches to ensure specialty shape is safely and securely in place after installation.
3. Perform any necessary finish work to complete the installation (see page 44).

Arch Top and Angle Top Panels

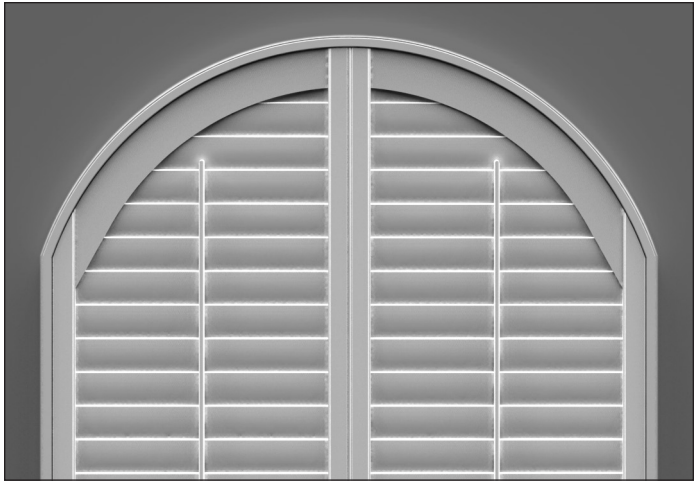

Step A. Assemble the Frame

IMPORTANT: Be careful when moving assembled frames; support weight evenly to avoid placing torque on the joints.

1. Use Hoffman keys (see image below) to connect the bottom corners of the frame. If necessary, tap the keys securely in place using a rubber mallet, or a standard hammer and wood block.

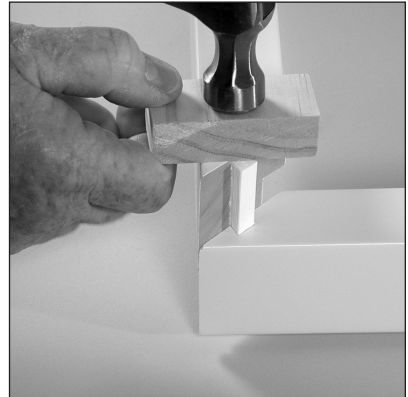
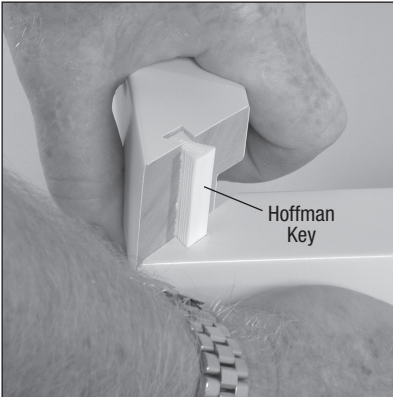

2a. If the curved or angled segments of the frame were spliced using a lap joint, align two segments and attach them using the provided screws.

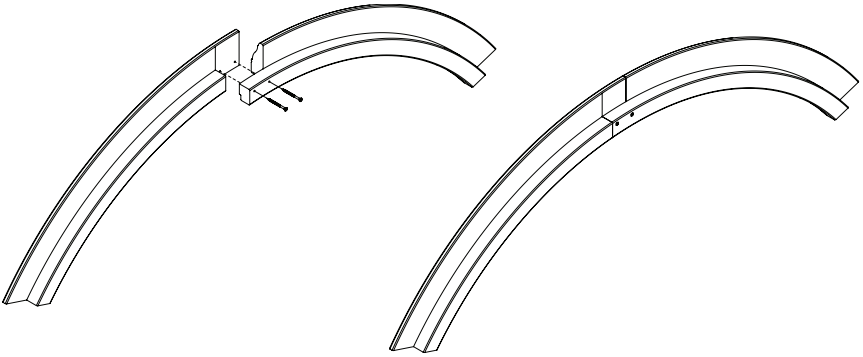

2b. If the curved or angled segments of the frame were spliced using a dowel and pocket screw combination, follow the steps below to attach the segments.

- Insert the dowels on one segment into the dowel holes on the other. Press the segments together as tightly as possible.

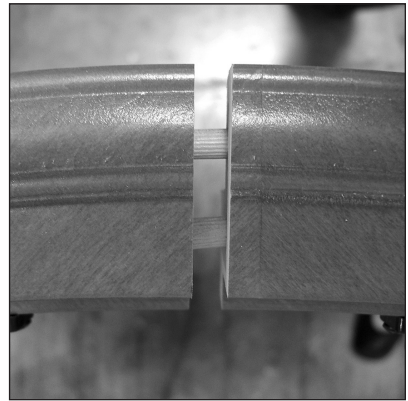
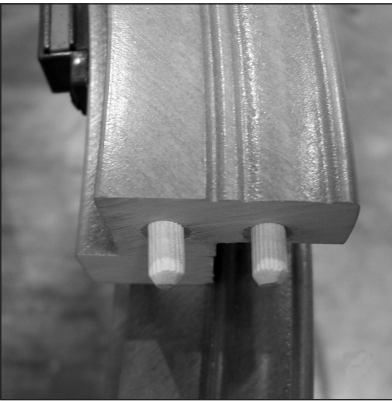

- Finish securing the frame segments by installing a screw in the pre-drilled hole on one side of the dowels. Tighten the screw until the frame segments are tightly flush against each other.

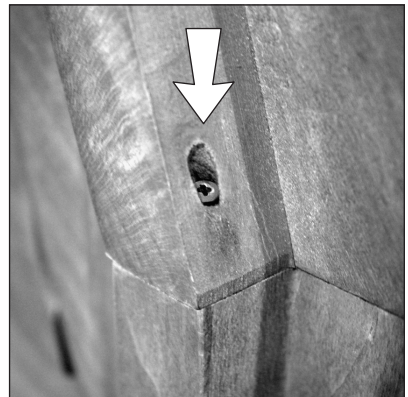

Step B. Install the Frame

1. Center the frame over (OM) or into (IM) the opening.
2. Attach the bottom frame and bottom side frames first, using screws through pre-drilled holes as you would for a standard panel shutter.
3. Spread the side frames at the shoulders if narrower than the bottom so that the panel(s) will have sufficient closure space.
 - It's common for the frame to be narrower at the shoulder compared to the bottom width.
 - Secure the side frames just below the shoulder. Be sure the side frames are vertical. With outside mounts, there should be an equal reveal top to bottom.

IMPORTANT: When placing screws, be careful not to distort the shape of the frame. Do not overtighten the screws.

Step C. Mount the Panel(s)

1. Place the panels into the frame by fitting the pin end of the hinges into the hinge barrels as you would for a standard panel shutter.
2. Close the panel(s) and check for proper alignment. If misaligned, use the shoulder screws to square the panel(s).
3. Secure the arch or angle area. Move the arch or angle portion of the frame to match the top of the squared panel(s).
4. Perform any necessary finish work to complete the installation (see page 43).

No-Measure Magnets

Most shutters come with magnets attached. If they are not attached, follow the mounting procedure described below:

1. Mark the frame top and bottom where the panel's rail and stile meet.



2. Using the flat head screw provided, mount the strike plate to the rail.
 - Position the strike plate flush with the edge of the shutter rail and tight against the stile.
 - Attach the strike plate with the screw as shown. Make sure the head of the screw is flush with or below the surface of the strike plate.

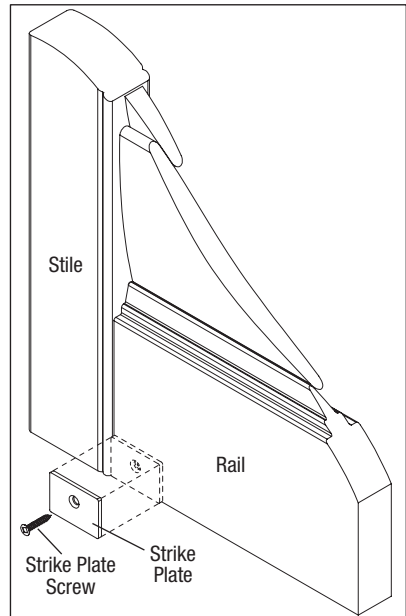

3. Mount the magnet base to the frame's light stop.
 - Position the base so that the edge of the magnet is aligned with your pencil mark, and the magnet "face" is on the hinged side of the mark.
 - Use the pan head screws provided and place the screws in the center of the slots to allow the magnet to move if adjustment is required.
 - For unframed applications where light stop will not be installed top and bottom, a magnet spacer will be sent. Attach the spacer to the magnet base then use the long magnet screws to mount the magnets.

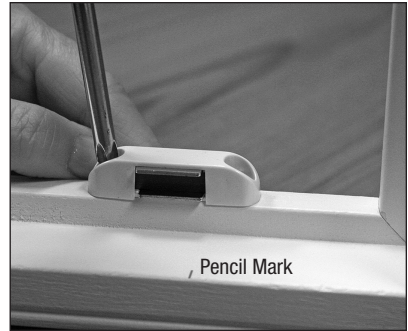

Touch-Up and Inspection

1. Fill all visible nail holes and/or countersunk screw holes. Clean up any excess wax.



2. Invite the home owner to inspect the installation.
3. Give the homeowner the Hunter Douglas warranty card.
4. Demonstrate proper operation of the shutters (see page 45).
5. Show the customer the location of their individual authenticity plate serial number.

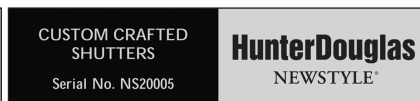
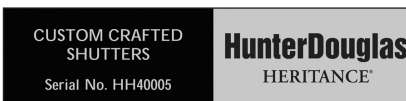

6. With installations of Heritage® hardwood shutters, give the homeowner the Heritage Arbor Day Certificate.

Operation

- Tilt the louvers by grasping one louver and moving it. **Do not** use the tilt bar to tilt the louvers.
 - With arches and other specialty shapes, the louvers operate independently. To tilt the louvers, grasp and gently turn. Work left to right and align all louvers in a sunburst design.
- Open the shutter panel by grasping the stile through open louvers and pulling out. **Do not** use the tilt bar to open the shutter panel.
- Standard bypass track system must have louvers closed before operating panels.

IMPORTANT: To open the panels on a bi-fold track system, collapse the first set of panels at the pivot side followed by each successive set of panels until all panels are collapsed.

IMPORTANT: When using floor guides with a bypass track system, use caution when operating panels to avoid panel damage where the guides contact the stiles.

Care

- Clean using a dry and soft feather duster, clean cloth, dust cloth or dusting mitt. A vacuum with the soft brush attachment can also be used.
- Ultrasonic cleaning or use of chemical solvents and scrubbing cleansers are not recommended. This will damage the product.
- Protect all fine wood and wood hybrid products from exposure to steam or high moisture areas, rain, or outside irrigation systems to ensure their long life.
- When cleaning any window, spray glass cleaner on a cloth rather than spraying directly on the window. This will prevent damage to the wood finish by splattering cleaner.

Louver and Louver Pin Replacement

Louvers connect to stiles via two louver pins, one at each end of the louver. There are three types of louver pins:

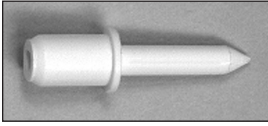

Standard Louver Pin
Provides no tension

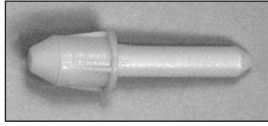

Tension Louver Pin
Provides louver tension

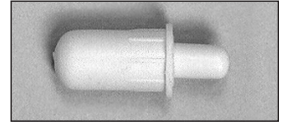

Replacement Louver Pin
Spring-loaded for louver replacement

Step A. Remove the Louver

1. Lay the panel on a flat surface and cut through a louver pin on either end of the louver using a painter's putty knife and a hammer or rubber mallet.
 - The putty knife should have a thin but rigid shaft with a sharp beveled edge.
 - Position the putty knife between the stile and louver. Strike the putty knife with the hammer or mallet to cut through the louver pin.
2. Detach the louver from the tilt bar.



- **Front tilt:** The front tilt bar connects to the louver with interlocked staples. Use offset needle nose pliers to remove the staple from the **front of the louver**. (If the staple is to be reused, lay it aside.)
- **Rear tilt:** The rear tilt bar connects to the notched end of the louver with a knurled pin. Loosen the pin by gently pulling the rear tilt bar away from the louver, then pull it out using needle nose pliers. (If the pin is to be reused, lay it aside.)

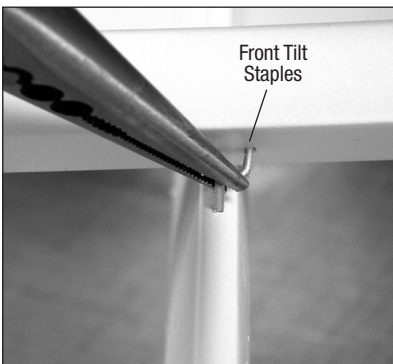

3. Raise the free end of the louver and remove it from the panel.
4. Carefully remove the remaining piece of the louver pin from the stile with the sharp tip of a knife or other tool.

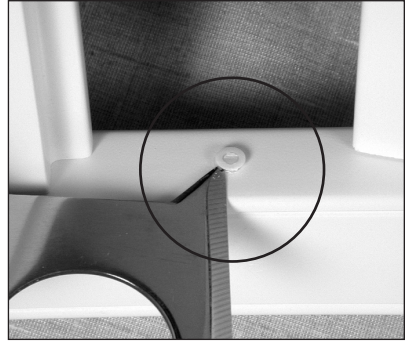

Step B. Replace the Louver

1. If you are reusing the louver that was removed, start by removing the remaining section of broken pin from the end of the louver. Use either a sharp tip or a drill bit.
2. Insert the correct type of louver pin into one end of the louver. Seat a **replacement pin** into the **stile** at the opposite end.

- **If you have removed the louver to add tension:** Insert a **tension pin** into the louver.
- **If you have removed the louver to reduce tension:** Insert a **standard pin** into the louver.



IMPORTANT: Most louvers have a slight bow or crown. With **front tilt** systems, orient the crown of the replacement louver to align with the louvers above and below.

3. Insert the louver pin on the louver into the stile opposite the replacement pin.
4. Using the tip of a thin putty knife, depress the spring section of the replacement pin. Slide the louver over the pin and pull out the putty knife.
5. Slowly move the louver across the pin until the stem seats into the louver hole. Wiggle the louver to check that it is secure.



TROUBLESHOOTING

6. Re-attach the louver to the tilt bar.

- **Front tilt:** Replace the staple into the louver.
 - a. Place a small dab of super glue gel on the ends of the staple.
 - b. Insert the staple through the tilt rod staple and into the louver.
 - c. Press the staple into the louver until it matches the depth of the other staples in the panel.
 - d. Tilt the louvers to check for proper operation.

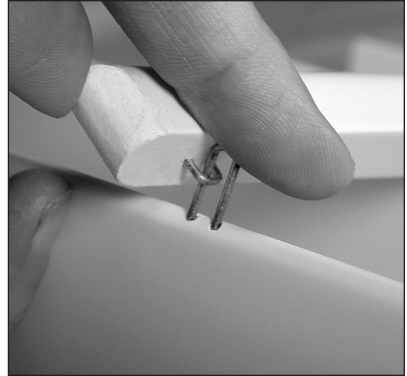

- **Rear tilt:** Replace the knurled pin.
 - a. Place a small dab of super glue gel on the tip of the knurled pin.
 - b. Press the pin through the tilt bar eye and into the hole that is located on the notch of the louver.
 - c. Tilt the louvers to check for proper operation.

LIFETIME GUARANTEE

The Hunter Douglas® Lifetime Guarantee is an expression of our desire to provide a thoroughly satisfying experience when selecting, purchasing and living with your window fashion products. If you are not thoroughly satisfied, simply contact Hunter Douglas at (888) 501-8364 or visit hunterdouglas.com. In support of this policy of consumer satisfaction, we offer our Lifetime Limited Warranty as described below.

COVERED

BY A LIFETIME LIMITED WARRANTY

- Hunter Douglas window fashion products are covered for defects in materials, workmanship or failure to operate for as long as the original retail purchaser owns the product (unless shorter periods are provided below).
- All internal mechanisms.
- Components and brackets.
- Fabric delamination.
- Operational cords for a full 7 years from the date of purchase.
- Repairs and/or replacements will be made with like or similar parts or products.
- Hunter Douglas motorization components are covered for 5 years from the date of purchase.

NOT COVERED

BY A LIFETIME LIMITED WARRANTY

- Any conditions caused by normal wear and tear.
- Abuse, accidents, misuse or alterations to the product.
- Exposure to the elements (sun damage, wind, water/moisture) and discoloration or fading over time.
- Failure to follow our instructions with respect to measurement, proper installation, cleaning or maintenance.
- Shipping charges, cost of removal and reinstallation.

Hunter Douglas (or its licensed fabricator/distributor) will repair or replace the window fashion product or components found to be defective.

TO OBTAIN WARRANTY SERVICE

1. Contact your original dealer (place of purchase) for warranty assistance.
2. Visit hunterdouglas.com for additional warranty information, frequently asked questions and access to service locations.
3. Contact Hunter Douglas at (888) 501-8364 for technical support, certain parts free of charge, for assistance in obtaining warranty service or for further explanation of our warranty.

NOTE: In no event shall Hunter Douglas or its licensed fabricators/distributors be liable or responsible for incidental or consequential damages or for any other indirect damage, loss, cost or expense. Some states do not allow the exclusion or limitation of incidental or consequential damages, so the above exclusion or limitation may not apply to you. This warranty gives you specific legal rights, and you may also have other rights which vary from state to state.

Different warranty periods and terms apply for commercial products and applications.

HunterDouglas



hunterdouglas.com

