

Not To Scale

Drawing by : MZM	Checked by : AEM	Approved by : Date :	Material : Stainless Steel Grade 316 to AISI/ASTM
 HAZ METAL FIXING SYSTEMS HAZ METAL Sanayi ve Ticaret A.S PO Box 241 31200 Iskenderun / Turkey Tel: +90 326 6262050 Faks: 6262045 info@hazmetal.com / www.hazmetal.com.			Title : Isometric
			Product Code : HA01 - 454
Date : 5/14/2016		Sheet 1 / 4	
Last Modification :			

PARTS LIST

ITEM	QTY	PART NUMBER
1	1	Through Bolt
2	1	Flanged Pin
3	1	Anchor Body
4	1	Serrated Washer
5	1	Plastic Tube
6	1	Round Washer
7	1	Nut

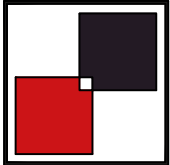
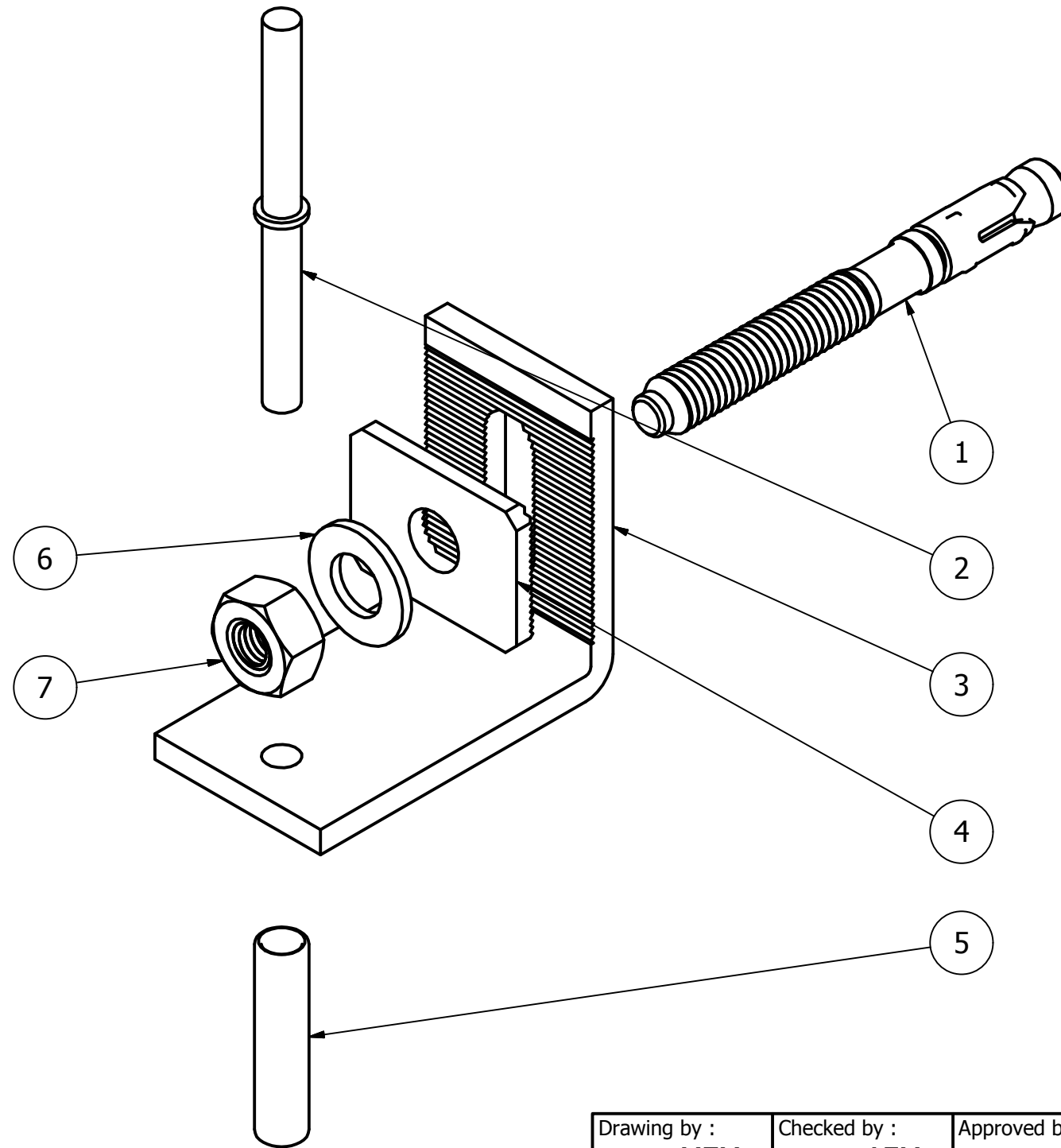

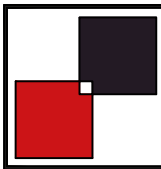
Drawing by : MZM	Checked by : AEM	Approved by : Date :	Material : Stainless Steel Grade 316 to AISI/ASTM
 HAZ METAL FIXING SYSTEMS HAZ METAL Sanayi ve Ticaret A.S PO Box 241 31200 Iskenderun / Turkey Tel: +90 326 6262050 Faks: 6262045 info@hazmetal.com / www.hazmetal.com.			Title : Explode Assembly
			Product Code : HA01 - 454
Date : 5/14/2016	Sheet 2 / 4		
Last Modification :			

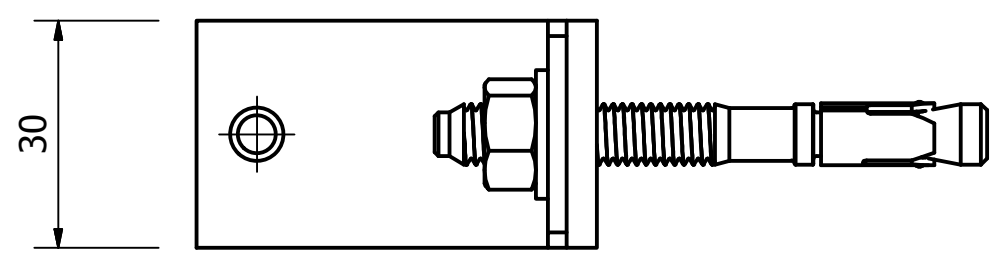
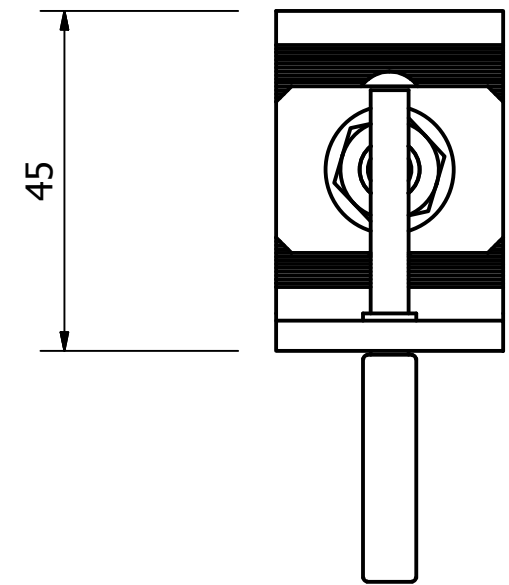
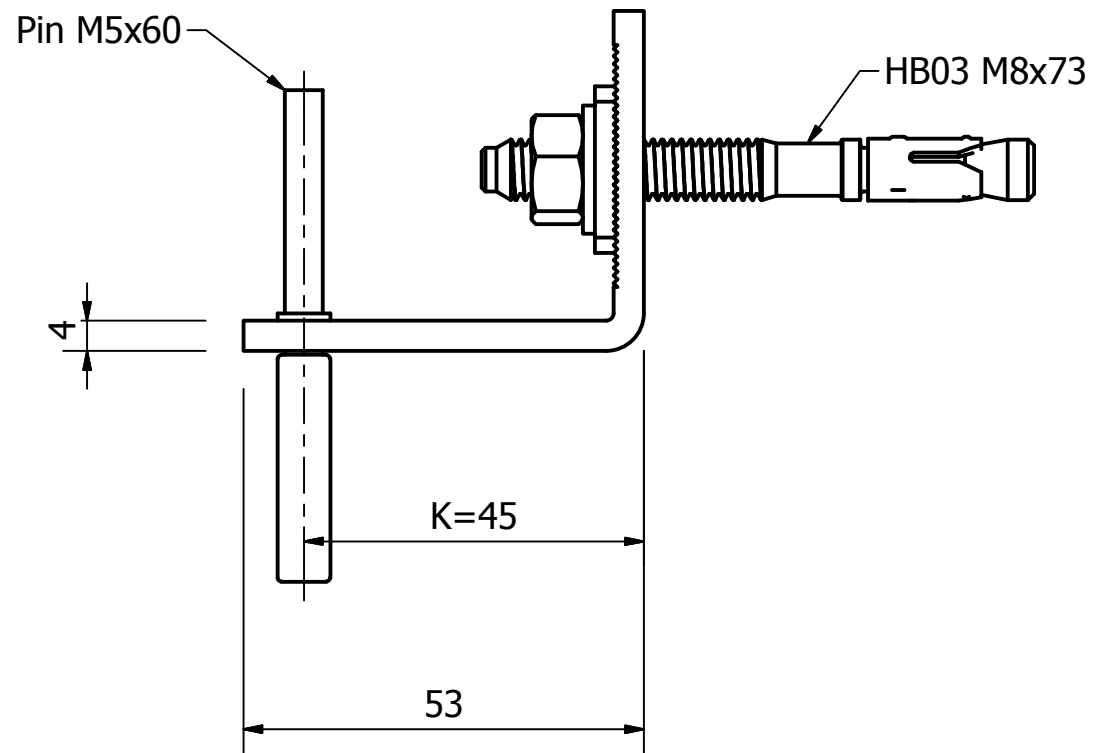

All dimensions are in millimetres u.n.o.

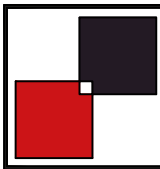
Drawing by : MZM	Checked by : AEM	Approved by : Date :	Material : Stainless Steel Grade 316 to AISI/ASTM
 HAZ METAL FIXING SYSTEMS HAZ METAL Sanayi ve Ticaret A.S PO Box 241 31200 Iskenderun / Turkey Tel: +90 326 6262050 Faks: 6262045 info@hazmetal.com / www.hazmetal.com.			Title : Orthographic Projections
			Product Code : HA01 - 454
Date : 5/14/2016		Sheet 3 / 4	
Last Modification :			

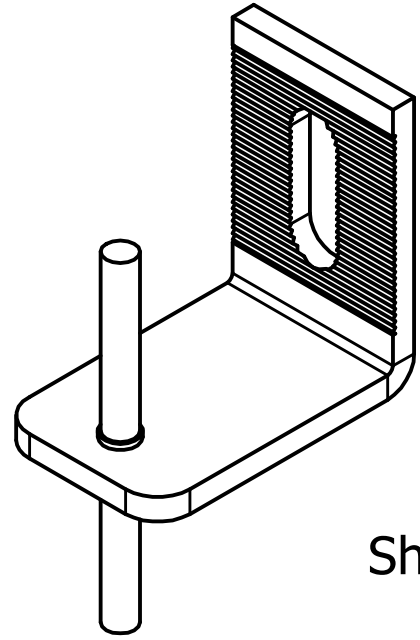

Shape A

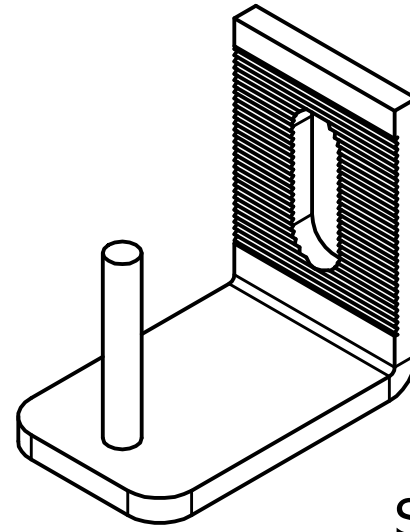

Shape B

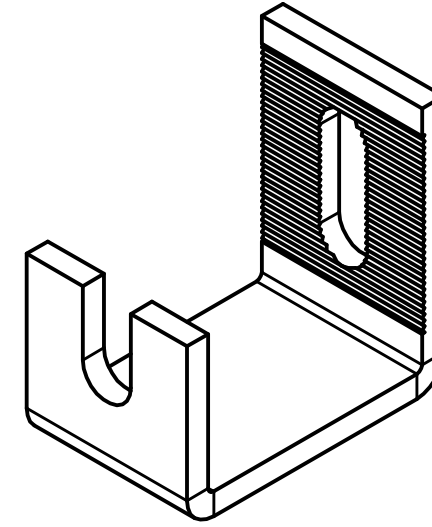

Shape C

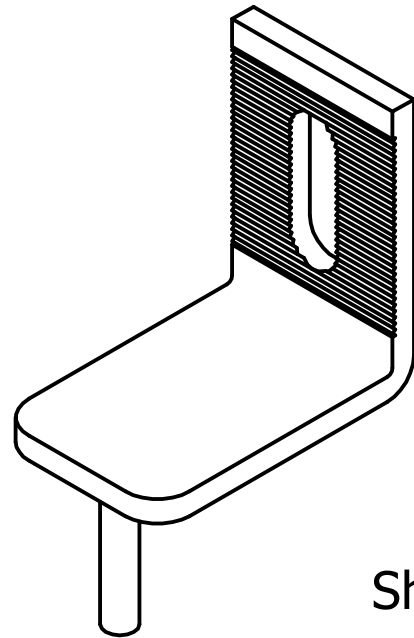

Shape D

Not To Scale

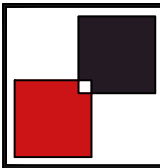
Drawing by : MZM	Checked by : AEM	Approved by : Date :	Material : Stainless Steel Grade 316 to AISI/ASTM
 HAZ METAL FIXING SYSTEMS HAZ METAL Sanayi ve Ticaret A.S PO Box 241 31200 Iskenderun / Turkey Tel: +90 326 6262050 Faks: 6262045 info@hazmetal.com / www.hazmetal.com.			Title : Anchor Variations
			Product Code : HA01 - 454
Date : 5/14/2016	Sheet 4 / 4		
Last Modification :			