

FLEET SERIES BOILERS

**Floor Standing, Condensing , Room Sealed,
Fully Modulating, Pre-Mix,
Gas Fired Boilers for Heating & Domestic
Hot Water Installations**

Installation, Commissioning and Operating Instructions

Models: F175V, F200V, F250V, F300V & F350V

NATURAL GAS I_{2H}

IMPORTANT NOTE

**THESE INSTRUCTIONS MUST BE READ
AND UNDERSTOOD BEFORE INSTALLING,
COMMISSIONING, OPERATING OR
SERVICING EQUIPMENT**

Customer After Sales Services

Telephone: **0845 450 2866** E-mail: **aftersales@hamworthy-heating.com** Fax: **01202 662522**

Technical Enquiries

To supplement the detailed technical brochures, technical advice on the application and use of products in the Hamworthy Heating range is available from our technical team in Poole and our accredited agents.

Site Assembly

Hamworthy offer a service of site assembly for many of our products in instances where plant room area is restricted. Using our trained staff we offer a higher quality of build and assurance of a boiler built and tested by the manufacturer.

Commissioning

Commissioning of equipment by our own engineers, accredited agents or specialist sub – contractors will ensure the equipment is operating safely and efficiently.

Maintenance Agreements

Regular routine servicing of equipment by Hamworthy service engineers inspects the safety and integrity of the plant, reducing the risk of failure and improving performance and efficiency. Maintenance agreements enable our customers to plan and budget more efficiently.

Breakdown service, repair, replacement

Hamworthy provide a rapid response breakdown, repair or replacement service through head office at Poole and accredited agents throughout the UK.

Spare Parts

A comprehensive spare parts service is operated from our factory in Poole, providing replacement parts for both current and discontinued products. Delivery of parts and components is normally from stock within seven days. However, a next day delivery service is available for breakdowns and emergencies.

FLEET SERIES BOILERS

**Floor Standing, Condensing , Room Sealed,
Fully Modulating, Pre-Mix,
Gas Fired Boilers for Heating & Domestic
Hot Water Installations**

Installation, Commissioning and Operating Instructions

**Models: F175V, F200V, F250V,
F300V, & F350V**

NATURAL GAS I_{2H}

**NOTE: THESE INSTRUCTIONS MUST BE READ AND UNDERSTOOD BEFORE
INSTALLING, COMMISSIONING, OPERATING OR SERVICING EQUIPMENT.**

THE FLEET BOILER IS INTENDED FOR USE AS A COMMERCIAL APPLIANCE AND IS NOT
CERTIFIED FOR USE IN DOMESTIC APPLICATIONS.

**THIS BOILER IS FOR USE ON GROUP H NATURAL GAS (2ND FAMILY) I_{2H} PLEASE
ENSURE RELEVANT INFORMATION REQUIRED WITHIN DOCUMENT IS FOUND
BEFORE FIRING BOILER.**

COUNTRY OF DESTINATION : UNITED KINGDOM & REPUBLIC OF IRELAND

THIS BOILER COMPLIES WITH ALL RELEVANT EUROPEAN DIRECTIVES.
PRODUCT IDENTIFICATION No. 86CM36

**PUBLICATION NO. 500001217
ISSUE 'F'
MARCH 2013**

CONTENTS

	PAGE
1.0 INTRODUCTION	1
2.0 SUPPLY AND DELIVERY	2
3.0 SIZE AND SPACE REQUIREMENTS	4
4.0 SITE LOCATION AND PREPARATION.....	7
4.1 Site Location	
4.2 Gas Supply	
4.3 Flue System	
4.4 Water Supply - including heat exchanger warranty conditions	
4.5 Condensate Connections	
4.6 Electrical Supply	
5.0 BOILER ASSEMBLY	14
5.1 General	
5.2 Water Connections	
5.3 Flue Connections	
5.4 Electrical Connections	
6.0 PRE-COMMISSIONING	15
6.1 Gas Supply	
6.2 Ventilation	
6.3 Pipework, Valves and Pump	
6.4 Flue	
6.5 Electrical	
7.0 CHECKS PRIOR TO LIGHTING	16
7.1 Boiler Gas System Leak Check	
7.2 Checks Prior to Lighting the Boiler	
7.3 Initial Lighting	
7.4 Combustion Checks	
7.5 User Instructions	
8.0 BOILER CONTROLS	20
8.2 Controls Operation	
8.3 Functions	
9.0 FAULT FINDING	36
10.0 SERVICING	38
11.0 REPLACEMENT OF FAILED COMPONENTS	40
12.0 RECOMMENDED SPARES	41

APPENDICES

APPENDIX A	GAS DATA	43
APPENDIX B	ELECTRICAL CONNECTIONS AND CONTROLS	44
APPENDIX C	FLUE DATA	47
APPENDIX D	VENTILATION	49
APPENDIX E	WATER DATA	51
APPENDIX F	HYDRAULIC DIAGRAMS - CASCADE CONTROL	70

PICTORIAL AND DIAGRAMMATICAL DATA

Figure 2.1	Boiler Packaging	2
Figure 2.2	Boiler Package Dimensions	3
Figure 3.1.1	Dimensions and clearances	4
Table 3.1.2	Dimensions and clearances	5
Figure 3.2.1	Water pipe work kit 3 high installation F175V - F250V	5
Figure 3.2.2	Water pipe work kit 3 high installation F300V - F350V	6
Figure 4.2	Gas connection	7
Figure 4.4	Water connections	9
Figure 4.5.1	Boiler condensate connection	12
Figure 4.6	Wiring schematic	13
Figure 7.1	Gas system leak check	16
Figure 7.2.1	On / OFF Switch	18
Figure 7.6	Combustion analyser probe position	18
Figure 7.6.1	Combustion settings	19
Figure 8.2	System configuration with LMU	20
Figure 8.2.1.1	Fascia Legend	21
Figure 8.1.6	General overview of boiler controls	22
Figure 8.2.1.2	Info display parameters	24
Figure 8.2.1.3	Operation and display philosophy	25
Figure 8.2.2	Screen legend	26
Figure 8.2.3.1	Default display	27
Figure 8.2.3.2	Display of status codes	27
Figure 8.2.4	Lockout display	28
Figure 8.2.5	Heating circuit setpoint	28
Figure 8.2.6	Overview of end user parameters	29
Figure 8.2.9	Operating mode	30
Figure 8.2.10	LMU Error codes	32
Figure 8.3.10	LMU Error log	33
Figure 8.3.11	Operating phases	34
Figure 8.3.12	Operating phases	35
Figure 9.2	Water flow switch	36
Figure 9.3.1	Wiring Schematic	37
Figure 10.2	Combustion chamber	39
Figure 10.2.1	Spark electrode position	39
Figure 10.2.2	Flame sensing probe position	39

APPENDIX	PAGE
Figure A1	Gas Data 43
Figure B1	Electrical Supply 44
Figure B1.2	External Control Wiring for Multiple Boiler Installation 45
Figure B1.3	Sensor resistance values 46
Figure C1	Flue Data 47
Table C6.1	B23 flue equivalent lengths 48
Figure D1	Mechanical Ventilation Flow Rates 50
Figure E1	Water Data 51
Figure E1.1	Typical Piping Layouts 53
Figure E1.4	Cold Feed & Vent Sizes 53
Figure E1.7	Pump performance curves 54
Figure E2	Typical pipe kit system connections 55
Figure F1	Hydraulic diagram 80 56

1.0 INTRODUCTION

1.1 This boiler must be installed by a competent person. All installations **MUST** conform to the relevant Gas Safety and Building Regulations. Health & Safety requirements must also be taken into account when installing any equipment. Failure to comply with the above may lead to prosecution.

1.2 This boiler is intended for use on Group H Natural Gas (2nd Family). The firing information is to be found in Appendix 'A'. Boilers **MUST NOT** use gas other than that for which they are designed and adjusted.

1.3 The 'Fleet' is a gas fired, fully modulating, pre-mix, condensing, room sealed central heating / hot water boiler, comprising of 8 models covering the range of 40 - 150kW output, which can be configured vertically in two or three high units (V series) upto three units wide, sharing common water pipe work - optional HHL supply. See figures 3.2.1 - - 3.2.5, for typical schematic layout.

1.3.1 Using the latest gas / air ratio control technology it is able to provide clean efficient operation across a large output range via the Merley Boiler Sequence Controller, ideally suited to installations that do not have a dedicated controls installation.

The Merley control provides cascade management for multiple boilers and simultaneous management of three different circuits operating at different temperatures. (radiators, dhw & under-floor heating).

Operation is initiated and controlled by a LMU boiler management system with a user interface LCD display for accessing and changing boiler parameters.

1.3.2 Each of the boiler models is designed for direct connection to a plastic flue system - HHL supply. The Technical Data for the various arrangements is given in Appendix C.

The flue outlets from individual modules are linked by a vertical flue manifold which may be connected to a single chimney (not HHL supply) up to a maximum length refer to Appendix C

No draught diverter is fitted to the boiler nor is a fixed diverter required in the flue system.

However, for B23 applications, the Hamworthy air inlet filter **MUST** be used to provide the correct clean air supply to the boiler. Refer to Appendix C.

1.3.3 The Fleet is intended for the heating of Commercial and Industrial premises, or large residential properties. It may also be used to supply hot water for these premises via an indirect cylinder.

1.3.4 The Fleet has a low water content and is fitted with an integral circulating pump to ensure that water flow rates are achieved - refer to Appendix E for available pump head to the system.

Accordingly in a primary circuit - refer Appendix E there is no need for a primary circulating pump.

1.4 The boiler is suitable for connection to open vented and un-vented (pressurised) heating system, care must be taken to ensure all extra safety requirements are

satisfied and that the relevant interlocks will shut the boiler (s) off should a high or low pressure fault occur.

The pressurisation unit must also incorporate a low level water switch which protects the water pumps and will directly or indirectly shut down the boiler plant should a low water condition occur. Consideration should also be given to the maximum working pressure of the boiler as given in Appendix 'E'. Consult Hamworthy Heating Technical Department for help or assistance if in doubt.

1.5 The Fleet boiler is not suitable for direct connection to domestic hot water supplies.

1.6 BOILER MODELS

2 or 3 high models

Fleet F175V - 350 or 525.	- output 350 or 525kW
Fleet F200V - 400 or 600.	- output 400 or 600kW
Fleet F250V - 500 or 750.	- output 500 or 750kW
Fleet F300V - 600 or 900.	- output 600 or 900kW
Fleet F350V - 700 or 1050.	- output 700 or 1050kW

1.7 Each Fleet boiler module is supplied with a vfc contact output for Normal Run and General Fault outputs, and 0~10v analogue control input compatibility.

1.8 Options - refer to individual kit instructions for details

1.8.1 Optional water pipe work kits are available for two or three high vertical units upto three units wide. These kits are free-standing allowing installation to the system prior to installing the boiler and incorporate all necessary valves, inter connecting pipework, and flow and return headers. Refer to individual kit instructions 500005134 for details.

1.8.2 Controls peripherals

The LMU boiler management system has the potential to accept the following control options:

1.8.2.1 External sensor

Allows direct weather compensation for multiple boiler systems.

1.8.2.2 Clip in module (LPB Bus)

Allows communication with multiple boilers under the control of a Merley Boiler Sequence Controller

1.8.2.3 Merley Boiler Sequencer Controller

Allows cascade management of up to 16 boilers, and interface with a BMS system.

2.0 SUPPLY AND DELIVERY

The boiler is despatched to site as a pre-assembled and tested unit. Each boiler is delivered by a tail lift vehicle and lowered to ground level. It is the installers responsibility to convey the boiler to the plantroom.

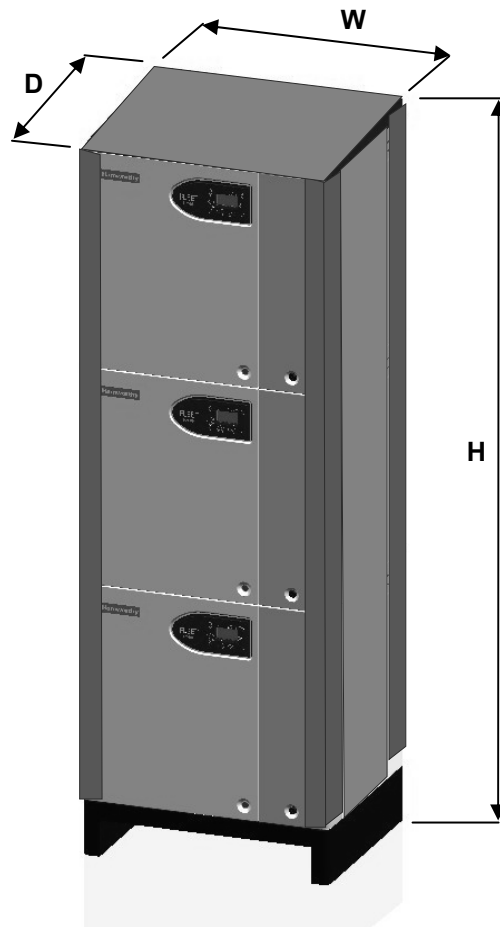

Figure 2.1 - Boiler Packaging

NOTE: The Fleet V series boilers **MUST** not be stacked. Once removed from the packaging, all boilers can be manoeuvred on a standard pallet truck. However, when handling and manoeuvring the boiler care must be taken to avoid damage to the casing. The flue system is packaged separately.

The boiler must be kept upright during handling.

The flue manifold connecting the vertical modules is supplied separately to the boiler - refer to Appendix C.

Warranty

Full warranty assistance will be covered when the appliance is commissioned by Hamworthy Heating Ltd, see Terms & Conditions for full details.

Hamworthy Heating Ltd will not accept any liability resulting from damage due to tampering, improper use, handling, installation errors, operation and maintenance. It is important to check for damage upon receipt of product, which if found must be notified to Hamworthy Heating Ltd immediately.

In the event of failure or breakdown, isolate the equipment and contact Hamworthy Technical Support
Tel - 0845 450 2866

Figure 2.2 - Boiler Packaged Dimensions

Model	H mm	W mm	D mm	Weight (kg)
F175V-350	1505	880	1235	414
F200V-400	1505	880	1235	432
F250V-500	1505	880	1235	492
F300V-600	1505	880	1515	581
F350V-700	1505	880	1515	643
F175V-525	2110	880	1235	598
F200V-600	2110	880	1235	628
F250V-750	2110	880	1235	728
F300V-900	2110	880	1515	854
F350V-1050	2110	880	1515	942
Flue manifold	900	300	300	10

Delivery Verification

When taking delivery please ensure that you have received the correct number of boilers and individual flue kits to fulfil your order. If any item is missing please contact our after sales service team. Please provide details of your order such as order number and contract number as well as a detailed description of the missing item.

Frame Set and Pipe work Header Kits

Where pipe work kits are supplied, these are packaged separately from the boilers. All ancillary items such as isolation valves and boiler make-up connectors are factory fitted and tested. The whole is shrink wrapped for security and basic protection. Refer to Kit instructions 500005134 for specific information.

3.0 SIZE AND SPACE REQUIREMENTS

3.1 The Fleet boiler range has been designed to utilise minimum floor space, therefore it is important that the plant room has sufficient ceiling height to allow for installation and connection to the flue system allowing for sufficient access at sides and behind boiler for pipe work connections. See Figure 3.1

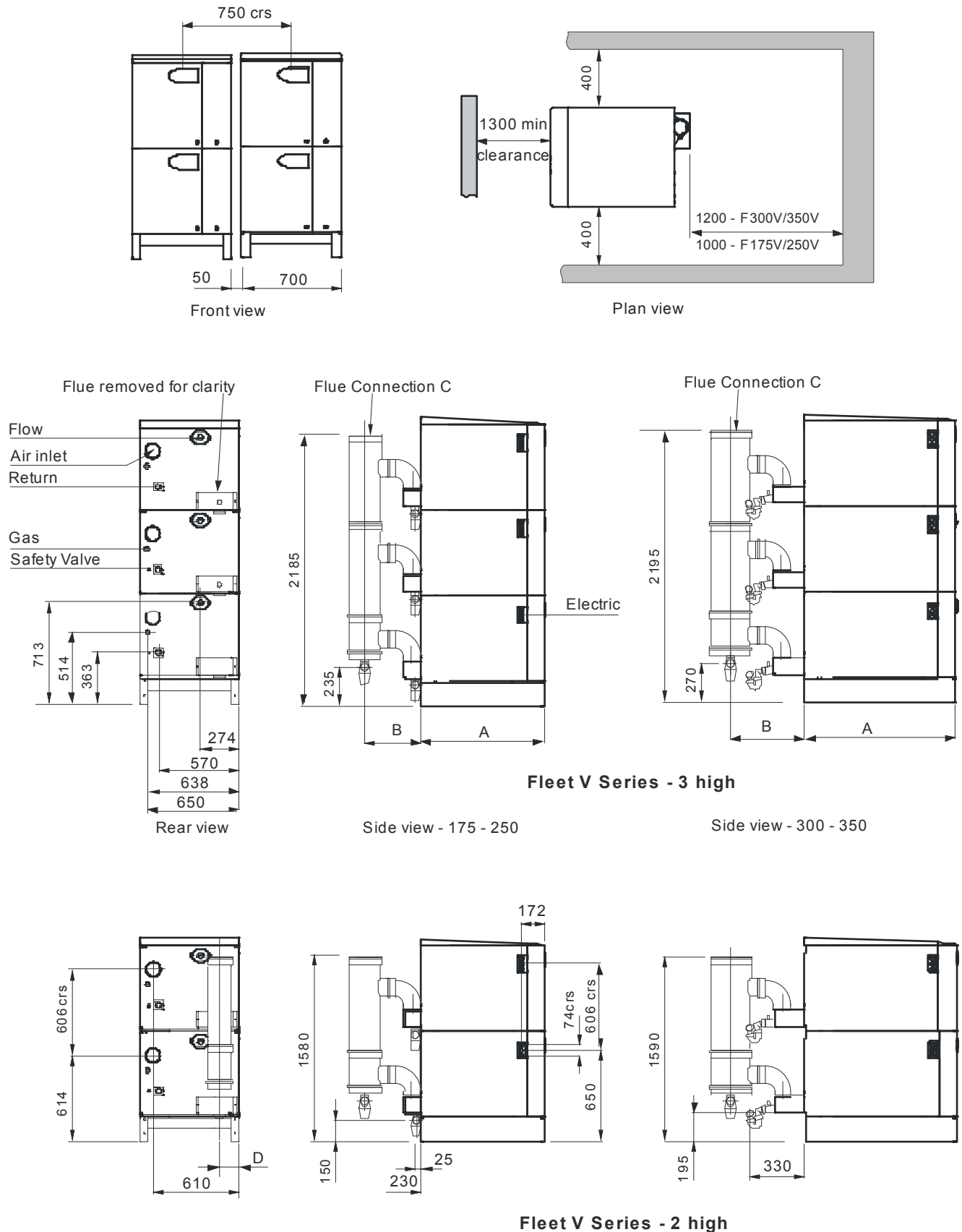

Figure 3.1.1 - Dimensions and Clearances

Dimension	BOILER MODEL			
	F175V -F250V		F300V—F350V	
	Two high	Three high	Two high	Three high
A	950	950	1145	1145
B	282	282	439	439
C	200	200	250	300
D	140	140	84	84

- C* - 200Ø flues can be adapted to 250Ø & 250Ø flues can be adapted to 300Ø using the HHL supplied adaptors.
- C** - A 250-300Ø adapter is standard fit on 300/900V & 350/1050V models

Table 3.1.2 - Dimensions and clearances

3.2 The Hamworthy Heating Ltd frame set and pipe work kit is designed to provide a compact solution for connecting the boilers to the gas supply and flow and return water connections. The kit locates the pipe work above the boiler casing. Refer to kit instructions 500005133 for specific information

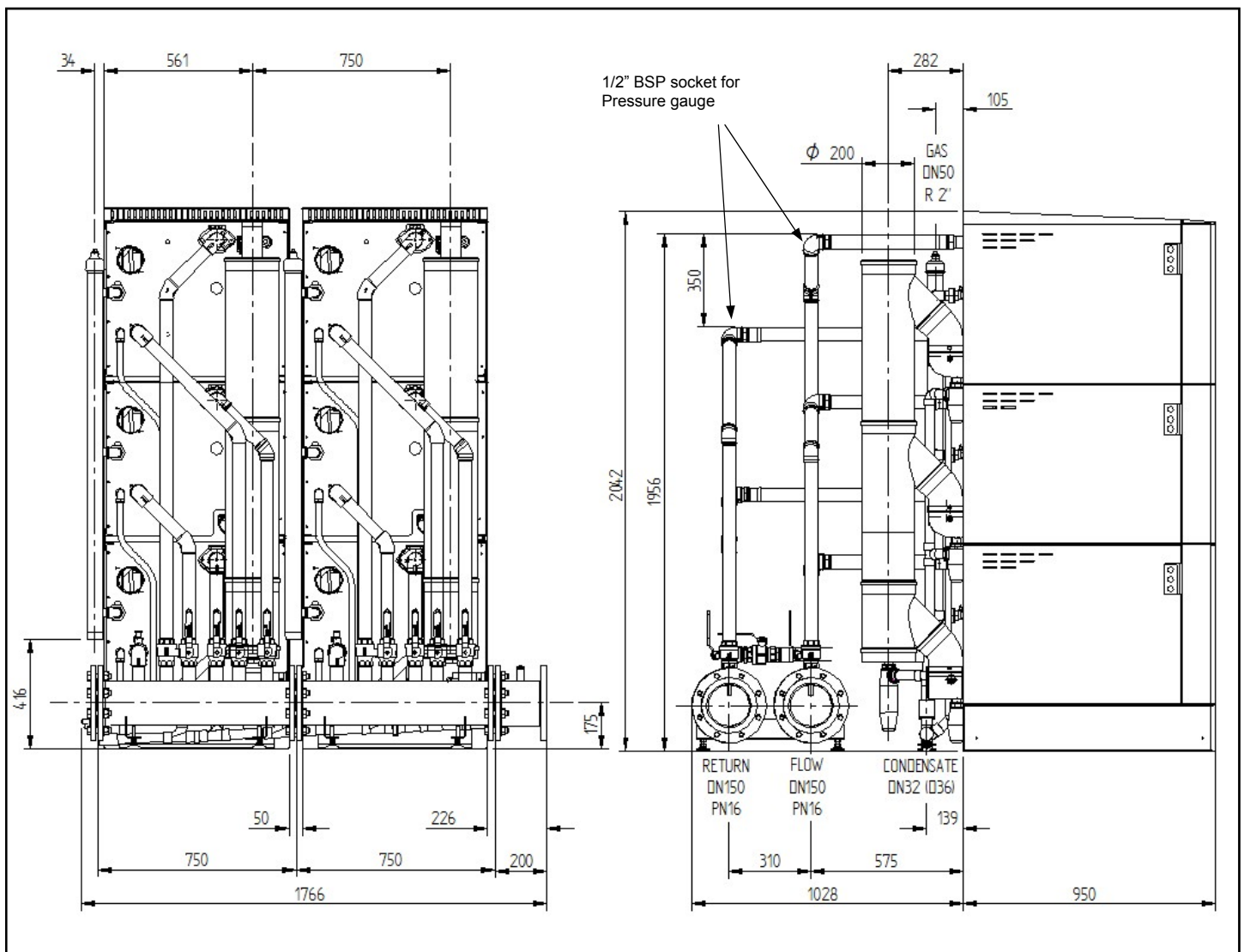

Figure 3.2.1 – F175/F250V - water pipe work kit (3 high boiler installation shown)

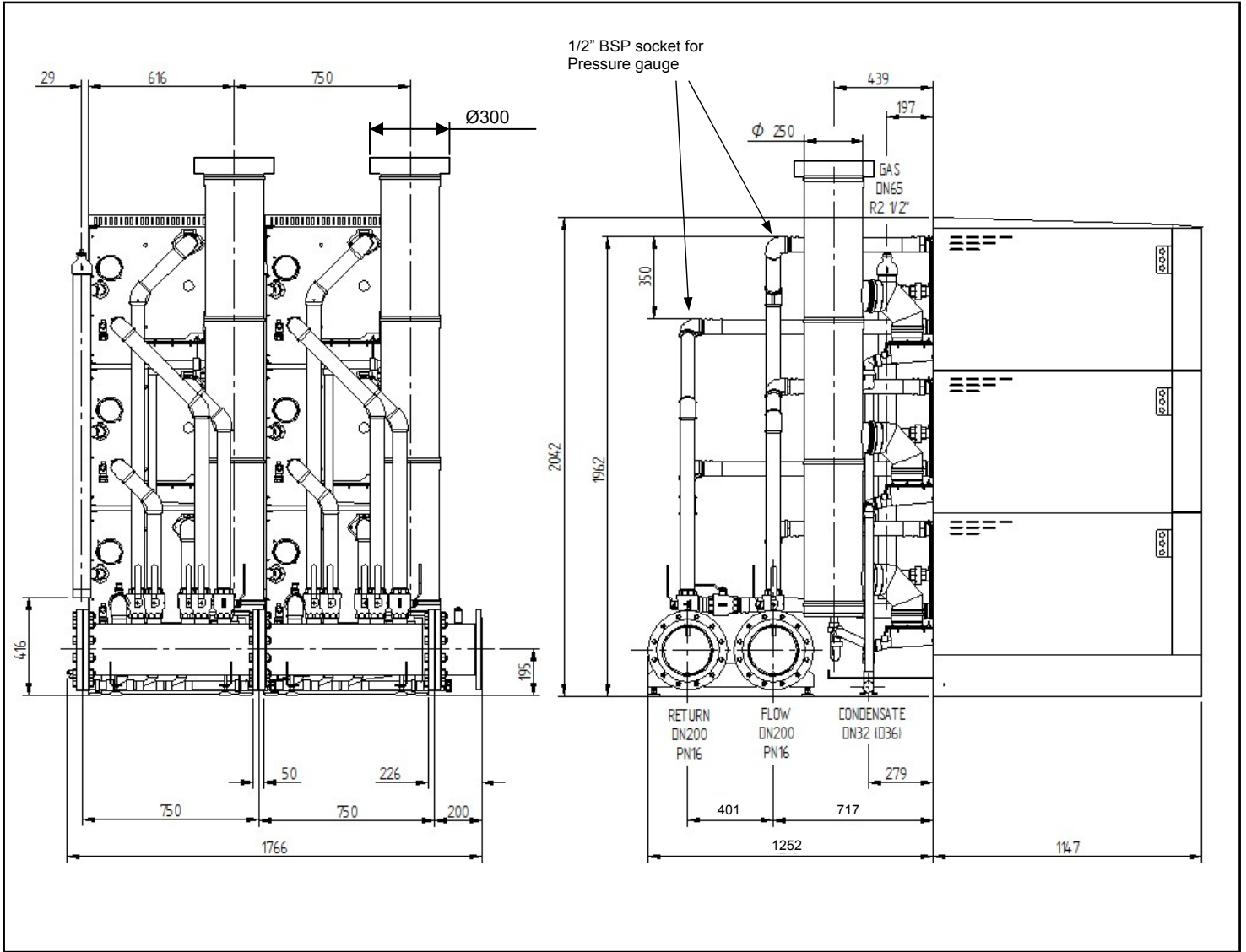

Figure 3.2.2 – F300/F350V - water pipe work kit (3 high boiler installation shown)

4.0 SITE LOCATION AND PREPARATION

4.1 Site Location.

- The boiler is heavy. Care must be taken when lifting the boiler
- The floor or plinth for the boilers and pipe work kit must be both flat and level to ensure correct alignment of fittings and connections.
- The floor or plinth must be sufficiently strong to support the weight of both the boilers and pipe work kit where used.
- The floor or plinth must be fireproof in accordance with BS 6644.
- The plant room must have sufficient space for installation of boilers, pipe work, pumps controls, flues ventilation, access and servicing and other items of plant.

4.2 Gas Supply.

- Gas supply pipes must be in accordance with BS 6891 or IGE/UP/2
- Gas supply connections to the boiler must not be smaller than the connection on the boiler - refer to Figure 4.2 & Appendix 2 for the connection size.
- Gas installation must be soundness tested to BS 6891 or IGE/UP/1 & IGE/UP/1A.
- Gas installation must be purged to BS 6891 or IGE/UP/1 & IGE/UP/1A.
- Inlet gas pressure to boiler measured at the gas valve, nominal 20mbar (minimum 17.5mbar) dynamic - refer to Appendix A
- Boiler house gas isolation valve must be clearly identified and installed close to the entrance / exit.

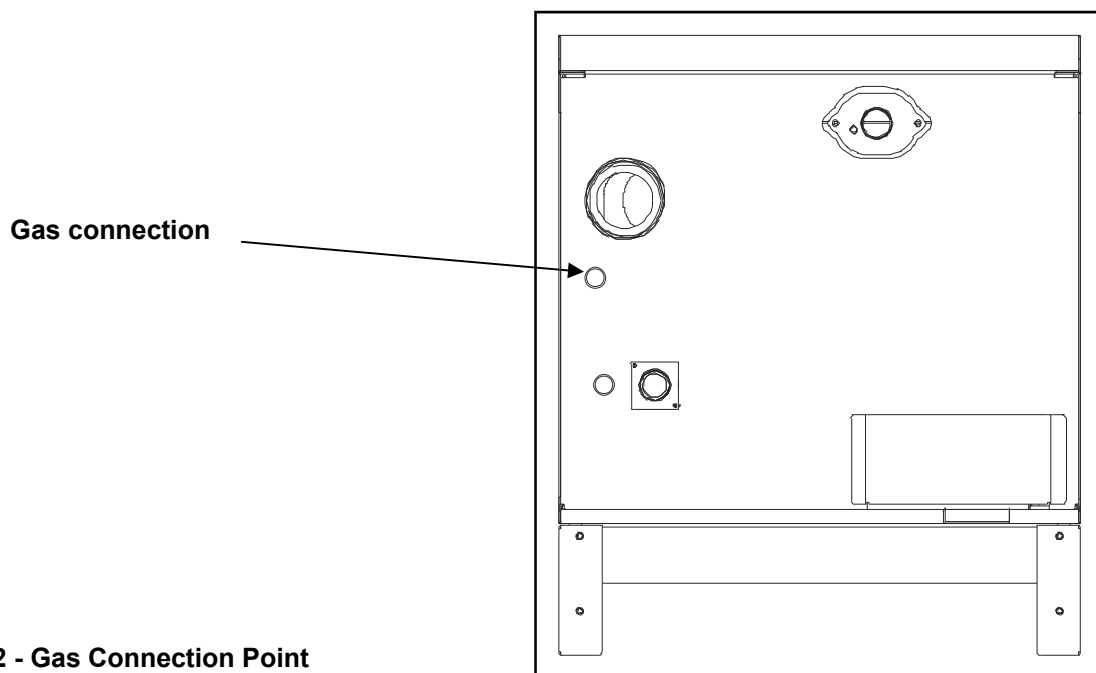

Figure 4.2 - Gas Connection Point

4.3 Flue System

- The Fleet flue systems supplied by Hamworthy are non UV stabilised polypropylene and are therefore suitable for internal use only. For external flue runs and termination, either use the dedicated kits supplied by Hamworthy or refer to a chimney specialist .
- Flue termination, routing and construction must comply with the requirements of the Clean Air Act 1956, BS 6644, BS 5440 and IGE/UP/10 where applicable.
- Fleet boilers installed in modular format with a common flue, must use the manifold provided with the boiler prior to any connection to the flue system which must be suitable for condensing application.
- Fleet V series boilers are suitable for open flue (type B₂₃) installation, drawing combustion air from the plant room, - see section 5.2. For type B₂₃ installations, the maximum number of modules firing into a common chimney is 9. For larger installations refer to HHL Technical. The flue system must be designed to limit the max. suction (cold) to 30Pa negative, measured at the connection to the boiler. If the suction is greater than 30Pa, refer to HHL technical.
This condition must then be checked hot and with all boilers firing, the max. pressure at the connection to the boiler should be 150Pa positive. In the event that the flue system when hot does generate a suction, the max. suction is 100Pa.
- For type B23 installations the Hamworthy air inlet filter MUST be used at all times. Refer to Appendix C.
- Any stabiliser fitted must be in or close to the vertical chimney.
- Due to the low flue gas temperature, (~50°C) condensation will occur in the flue, flue materials must be non-corrosive and utilise fully sealing joints.
- Adequate facilities must be provided for draining the flue condensation from the flue system using the components available from HHL - refer to Appendix C. Horizontal runs of flue must provide condense drainage from the flue /chimney and must slope at 3° (50mm/m) along the horizontal length, towards the boiler. The flue system MUST NOT drain through the boiler - see section 5.2 .
For multiple boilers into a common flue header, the common header must slope at 3° back to the boilers and provision made to remove condensate from the header - see section 5.2 .
- Horizontal flue runs must be kept as short as possible and be inclined at minimum 3° (50mm/m) towards the boiler.
For maximum equivalent flue lengths, refer to Appendix C.
- Any flue must be self-supporting and separable from the boiler for servicing requirements.
- Note: Due to high thermal efficiency of the Fleet boiler and the resultant low flue gas temperatures there will be visible pluming of the flue gases at the flue termination. This is likely even when the boiler is not operating at condensing temperatures.
- Fan dilution - the design must provide for the use of balancing and trim dampers, and their location and operation must be such that the constraints detailed above can be met. Care must be taken to ensure that the fan performance is matched to deliver the appropriate dilution, whilst ensuring that excessive suction is not applied to the boilers. If in doubt, refer to HHL Technical.

4.4 Water Supply

- Feed and Expansion tanks to comply with static height requirements of HSE document PM5.
- Cold feed and open vent pipes to comply with requirements of BS 6644.
- The Fleet boiler is fitted with an integral circulating pump, which will shut off circulation through the heat exchanger 5 minutes after the boiler has ceased firing. The pump head available from the boiler, is only suitable for circulation in the primary circuit. This must be acknowledged in the system design.
- Pressurised system to comply with BS 7074.
- Each module is supplied with a safety valve set at 6 barg to protect the boiler. It is imperative that a suitable safety valve is fitted to the installation in the event that the system design pressure is lower than the boiler maximum operating pressure, according to the requirements of BS6644 -2011
- The Fleet boiler has an aluminium heat exchanger. It is a requirement that the system & pipe work are flushed at least twice before adding water treatment and before installing the boiler. The system water **MUST** be treated and maintained with an appropriate inhibitor (eg. Sentinel X100) and the PH **MUST** be managed between 7 & 8.5. Failure to observe this requirement will invalidate the warranty detailed on the next page!
- In hard water areas precautions such as water treatment are strongly recommended to prevent the build up of sludge and scale.
- Leaks in the system pipe work **MUST** be fixed to prevent dilution of water treatment.
- Maximum working water pressure is 5.3bar.
- For minimum water pressure 0.5 bar - refer to Appendix E

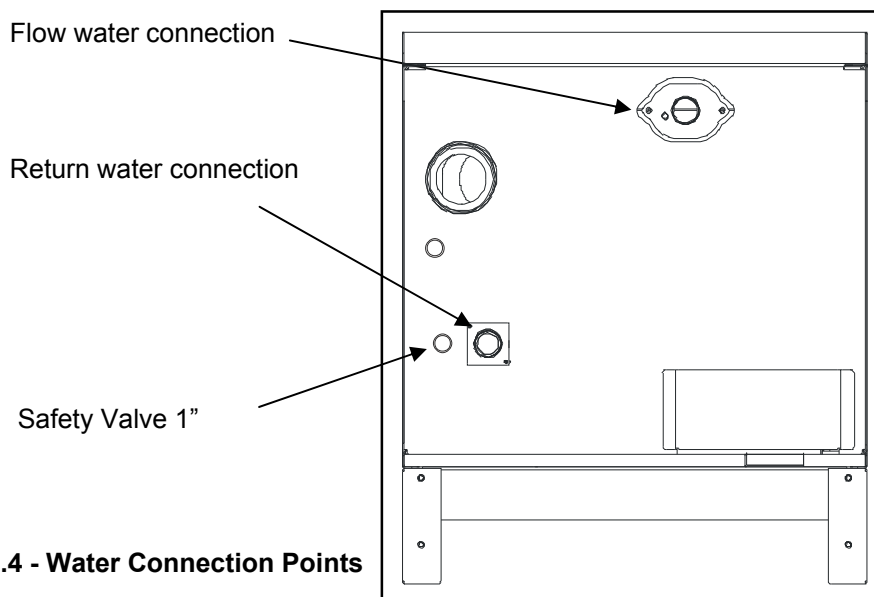

Figure 4.4 - Water Connection Points

Heat exchanger warranty conditions, to be read in conjunction with Hamworthy Heating Limited's terms and conditions of sale and service.

Heat exchanger warranties are conditional upon correct system design, installation, operation and maintenance in accordance with the manufacturer's instructions, relevant legislation and best practice.

In the event of defect or manufacturing fault it is the buyer's responsibility to prove so, clearly established and recognised by Hamworthy Heating Limited, the manufacturer's responsibility is as follows:

The warranty is limited to the supply of the part recognised to be faulty for a period of 5 years from date of delivery and all transport expenses but excludes labour costs inherent to disassembly and reassembly, unless commissioned by Hamworthy Heating Limited or an approved Sub Contractor.

THE APPLICATION OF THE WARRANTY IS SUBJECT TO:

Compliance with the manufacturer's recommendations as detailed in the operating and maintenance manual, ensuring that the commissioning is carried out by either Hamworthy Heating Limited or a competent engineer. To ensure that the settings and checks noted on the commissioning sheet (included in the maintenance manual) are recorded and detailed within the boiler log book.

That the boiler maintenance is carried out by Hamworthy Heating Limited or a competent maintenance company, the maintenance regime detail shall be provided in writing, when required, to prove compliance with the operating and maintenance literature.

Installation requirements shall be as defined and required by UK legislation, best practice and applicable European standards:

Water Supply

- Feed and Expansion tanks to comply with static height requirements of BS6880 & BS6644.
- Cold feed and open vent pipes to comply with requirements of BS 6644.
- Pressurised system to comply with BS 7074.
- It is required that the system pipe work is flushed twice with a suitable flushing and cleaning agent and before the new boiler(s) are installed (for example: Sentinel X300 for new systems, or Sentinel X400 for older systems) prior to the inclusion of water treatment

System water quality can be the cause of corrosion due to inappropriate Ph levels, oxygen presence and heterogeneity of different metal types within the system. To avoid this, the system water may have to be treated; the following limiting values must therefore be used for the composition of the heating water. (Please note: the guarantee may become null and void if the installation is not flushed and/or the water quality is inadequate).

Element	Composition
Acidity Level (untreated water)	7.0 - 8.0 pH
Acidity Level (treated water)	7.0 - 8.5 pH
Conductivity (untreated water)	800 μ S/cm (at 25°C)
Chlorides	\leq 150 mg/l
Iron	\leq 125 ppm (treated)
Copper	\leq 1 ppm (treated)
Aluminium	\leq 1 ppm (treated)
Water Hardness (CaCo ₃),	\leq 300 mg/l

In line with the values above the following must also be taken into account:

- To ensure that the system is adequately protected against any possible corrosion of copper or copper-bearing alloys that may be present within the system. (Note: Azole should be present in treatment chemicals to sequester the copper in solution and protect any yellow metal (i.e. copper and brass etc) components within the system.
- The use of artificially softened water MUST be avoided due to its corrosive characteristics
- To ensure that any electrolytic action and subsequent corrosion is prevented. Electrolytic corrosion can occur between dissimilar metals in the heating system, such as copper, brass, aluminium alloy and steel.
- To ensure that the use of a chemical corrosion inhibitor is used to protect the entire system.
- Leaks in the system pipe work MUST be fixed to prevent dilution of water treatment.

It is a condition of this warranty that the appropriate water treatment is applied and that the products used have been found suitable for all materials used in the central heating system. Periodic inspections should be built into the service regime and where required replacement of inhibitors is undertaken. Although there are a wide range of water treatment products available, the following are compatible and should be considered:

Sentinel Performance Solutions Ltd:

- Sentinel X100 (protection agent)
- Sentinel X200 (lime scale remover)
- Sentinel X300 (cleaning agent for new installations)
- Sentinel X400 (cleaning agent for existing installations)
- Sentinel X500 (antifreeze plus protection agent)

Fernox:

- Restorer (cleaning agent, for removing rust, lime and sludge)
- Protector (protection agent)
- F1 (protection agent)

The following applies to system design:

- In order to avoid thermal shock, water flow must not be able to be interrupted before the boiler stops firing.
- There must be provision to ensure that the heat exchanger is not susceptible to air locks.
- The air separator must be correctly sized and be equipped with an appropriate vent.
- A dirt separator must be correctly sized and fitted in the return close to the boiler(s)
- The system pressure must be in accordance with the information detailed within the operating and maintenance manual (minimum 0.5 bar cold fill and 5.3 bar maximum working pressure).
- A filter must be mounted on the return pipe to the boiler(s).
- Minimum flow rates must be adhered to (as detailed within the operating and maintenance manual)

In particular, but not limited to, the following conditions are not covered by the 5 year heat exchanger warranty:

- Defects resulting from incorrect installation, application, use, lack of the appropriate maintenance regime (in accordance to the operating and maintenance manuals), deterioration or accident due to negligence or involvement by an unauthorised third party.
- Damage due to acts of God, freezing, electrical storms, water damage, faulty flues, incorrect ventilation of the boiler room, and, in general, any action, negligence or clause recognised to be of an exceptional nature.
- Presence of aggressive vapours (chlorine, solvents, etc...).
- Boiler gas configuration or type which is not appropriate to the type of gas approved for the appliance.
- Damage caused by use of spare parts not compatible with the product.
- Operation of the product at system pressures above that for which it was designed and manufactured.

4.5 Condensate Connections

- Provision must be made for removal of condensate from the boiler and flue system.
- If the flue system is longer than the standard length of 0.9m, an inline condensate drain must be fitted immediately before the connection of the flue system to the boiler and taken to drain.
- Condensate is mildly acidic, typically pH3 - pH5.
- Condensate pipe work must be non-corrosive and not copper. Hamworthy recommend plastic waste pipe.
- Condensate may be discharged to a standard drain subject to National or Local regulations.
- Location of condensate pipe work should prevent freezing within tundishes, traps and pipe work.
- The connection to the boiler condensate drain accepts a straight push-fit coupling for 32mm i.d. (40mm o.d) plastic waste pipe.
- Maximum condensate production - 15 l/h per 100kW firing capacity

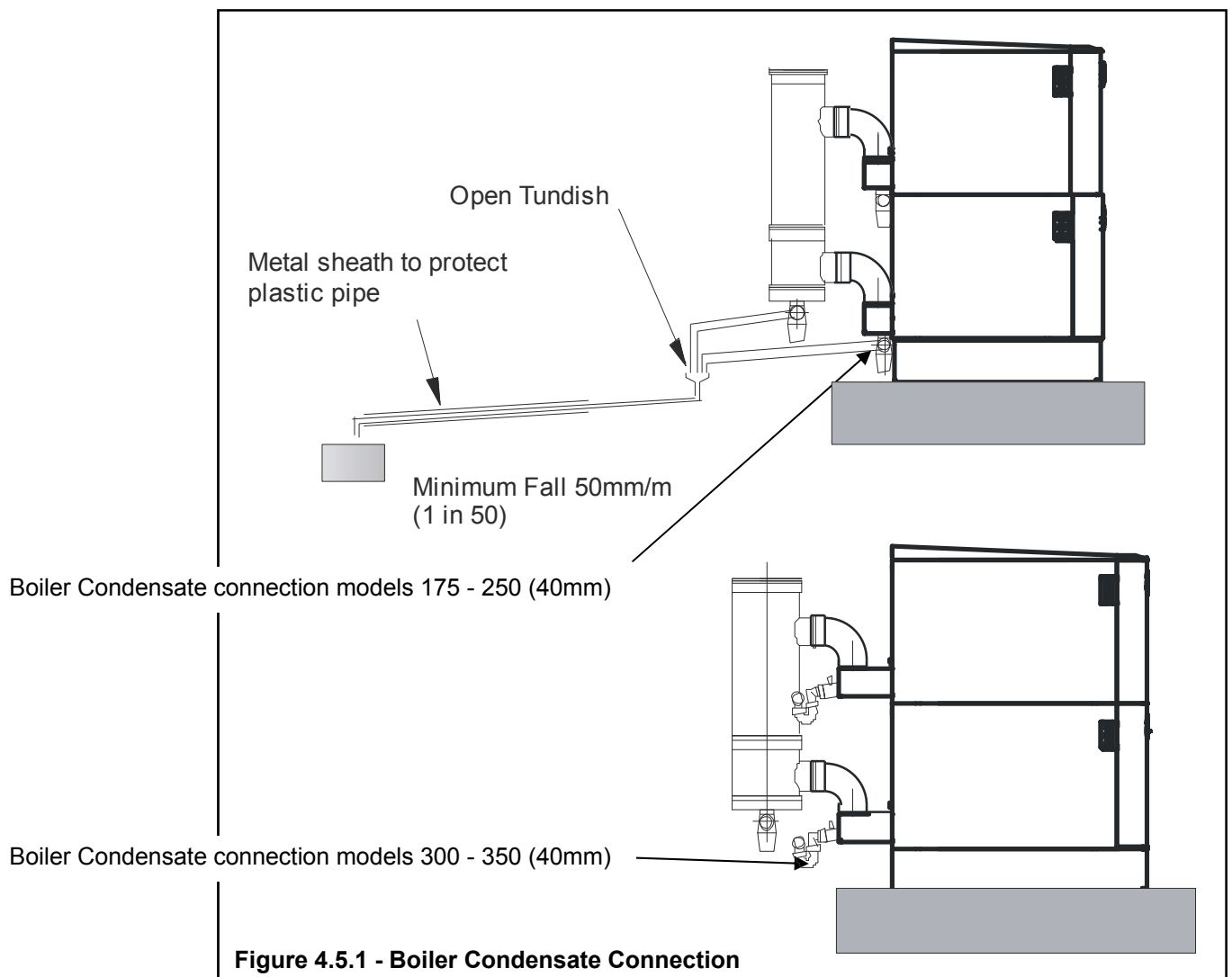

4.6 Electrical Supply

WARNING! THIS APPLIANCE MUST BE EARTHED IN ACCORDANCE WITH IEE REGULATIONS

- Boiler electrical supplies must not be switched by a time clock.
- Boilers are suitable for 230Volt, 50Hz supply.
- External fuses should be rated for 15 amps
- Wiring must be completed in heat resistant cable size 1.0mm² csa.
- Each boiler MUST have individual means of isolation.
- Electrical isolators must facilitate complete electrical isolation.
- Electrical isolators must have contact separation of minimum 3mm in all poles.
- Electrical isolators must be installed in readily accessible locations.
- Electrical supplies to boiler modules should only serve the boiler.
- Where an external alarm is required, terminals are provided which are volt free and rated at 230v.
- Time clock control should be via the boiler modules stop/start circuit (24V DC).
- Any interlock circuit must be in series with the time control for each circuit. The interlock circuit must never be used to isolate the boiler electrical supply.

ADDITIONAL INFORMATION REGARDING ELECTRICAL SUPPLIES IS GIVEN IN BS EN60335, Part 1.

NOTE: The appliance must be isolated from the electrical supply if electric arc welding is carried out on connecting pipe work.

FOR TYPICAL SCHEMATIC DETAILS SEE FIGURE 4.6

FOR DETAILED WIRING INSTRUCTIONS SEE FIGURES 9.3.1 AND APPENDIX B

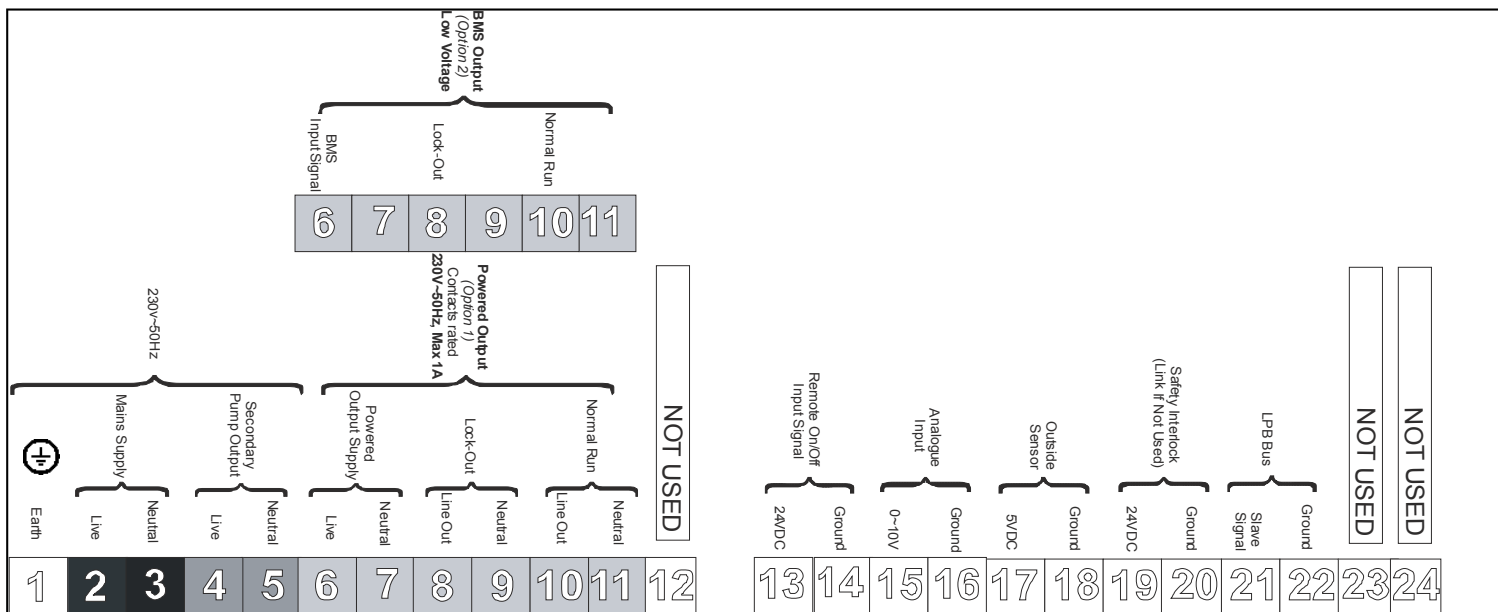

Figure 4.6 - Wiring Schematic

5.0 BOILER ASSEMBLY

5.1 General

Boilers are despatched to site as fully assembled units. The flue components (where applicable) and pipe work kit (where applicable) are the only items that will need assembling on site.

During assembly it is important to take care to prevent damage to the boiler casing.

Boiler positioning must allow the minimum clearances detailed in Section 3.0 to facilitate access for flue and pipe work connections as well as maintenance. The boiler must be installed on a solid floor. In locating the boiler a pallet truck is recommended so as to avoid damage to the casing parts

Health and safety. Due to the weight of the boiler, care must be taken when manoeuvring the boiler. HHL suggest the use of a pallet truck

5.2 Water Connections

The connections provided on the boiler (refer to Appendix E and figure 4.4) are suitable for direct connection to the system pipe work. However HHL recommend the use of individual isolating valves, which should be fitted to each module to enable isolation from the system. However, the arrangement must comply with the requirements of **BS 6644**.

When installing water system pipe work, it must be self supporting and care must be taken to ensure that undue stress is avoided on the boiler flow and return connections. It is recommended that unions are fitted local to the boiler and outside of the casing, to permit future servicing requirements.

Each module is fitted with safety valve rated at 6bar. The valve discharge pipe is routed to the rear of the boiler, where it must be piped to discharge via a tundish (not HHL supply) suitably located for ease of visibility.

The Fleet is designed to operate at 20°C ΔT across the flow and return. Should the flow rate drop, the boiler controls will modulate the burner to maintain 20°C ΔT . The boiler module is fitted with a single speed circulating pump and flow is controlled through a balancing valve, which must be checked and set during commissioning. As a safety precaution, a flow switch is fitted to the boiler heat exchanger to shut the system down in the event of sudden adverse flow conditions.

Where using Hamworthy Heating Ltd pipe work kits, assembly of these is detailed in Instruction Manual 500005133 supplied with kit.

5.3 Flue Connection

5.3.1

The Hamworthy Fleet V series boiler is designed for use with open flue systems type B23 - Intake from ventilated plant room and discharge via horizontal/vertical flue.

For open flue applications the HHL supplied air inlet filter (Pt.No. 532812008) MUST be used

1. With the boiler in its desired location, loosely engage the flue collector ducts into each other and position such that the spigots will fit into the respective flue sockets at the rear of the boiler. In assembling the flue ducts, it is advisable to lubricate the seal located in the socket fittings using the gel provided, to enable easy movement and adjustment.
2. Fit and secure the bottom closing plate to the base of the duct assembly.

Do not fit the flue manifold at this stage as it may restrict access to the other connections.

Note: Should modules be arranged in banks of 2 or 3 high, adjacent to each other, it is advisable to fit the water and flue connections to each individual bank prior to fitting the connections to the adjacent bank(s).

Flue systems should be designed with reference to **BS 6644**, **IGE/UP/10** and **Third Edition of the 1956 Clean Air Act Memorandum**.

Equivalent lengths for 90° bends and 45° bends are given in Appendix C.

5.4 Electrical Connections:

The following electrical connections are provided on each module.

- Supply: Live, Neutral and Earth. See Section 4.5 for details.
- Supply Input for Boiler Fault and Normal Run Signals
- Boiler General Fault Alarm Signal Output
- Boiler Normal Run Signal Output
- 0-10v Analogue Control Signal Input
- Remote on/off Control Input
- Boiler Shunt Pump Output
- Safety Interlock Circuit Input
- Optional LPB Bus for use with Merley boiler sequencer control

6.0 PRE-COMMISSIONING

The following pre-commissioning check must be carried out before the boiler is commissioned.

6.1 Gas Supply.

Ensure that gas installation pipe work and meter has been soundness tested and purged to IGE/UP/1 or IGE/UP/1A as appropriate. Test and purge certificates should be available for viewing.

6.2 Ventilation

Ensure that ventilation and air supply to plant room is correct.

6.3 Pipe work, Valves and Pump

Ensure that;

- System flushing and suitable water treatment has been implemented
- Pipe work and valve arrangement is installed to Hamworthy Heating recommendations.
- Circulating system is full of water, vented and pressurised appropriately.
- Circulation pump is operational.
- Pipe work connections to boiler are fitted correctly.
- All necessary isolation valves are open.
- Condense connections on boiler and flue are connected and piped to drain.
- Heat load is available.

6.4 Flue

Ensure that;

- Flue system is correctly designed and installed to suit boilers.
- Flue passages to chimney are clear.

6.5 Electrical

Ensure that;

- Electrical connections are correct and isolatable.
- External controls are operational.

WARNING: WHEN THE FRONT COVER IS REMOVED AND THE BOILER IS OPERATIONAL, CARE MUST BE TAKEN WITH ELECTRICAL COMPONENTS AND ACCESS TO PRIMARY INSULATION.

7.0 CHECKS PRIOR TO LIGHTING

IMPORTANT: BEFORE PROCEEDING ENSURE THAT THE PRE-COMMISSIONING CHECKS ON PAGE 14 HAVE BEEN CARRIED OUT AND THE RESULTS SATISFACTORY.

7.1 Boiler Gas System Leak Check

Ensure that the appliance manual gas service valve is in the **OFF** position. Although the boiler receives a gas leak check and gas train component integrity check prior to leaving the factory, transport and installation may have caused disturbance to unions, fittings and gas valve assemblies etc.

A procedure guide is given below. Care must be taken not to allow leak detection fluid (if used) on or near any electrical parts or connections.

NOTE: the test detailed below must be carried out on each module.

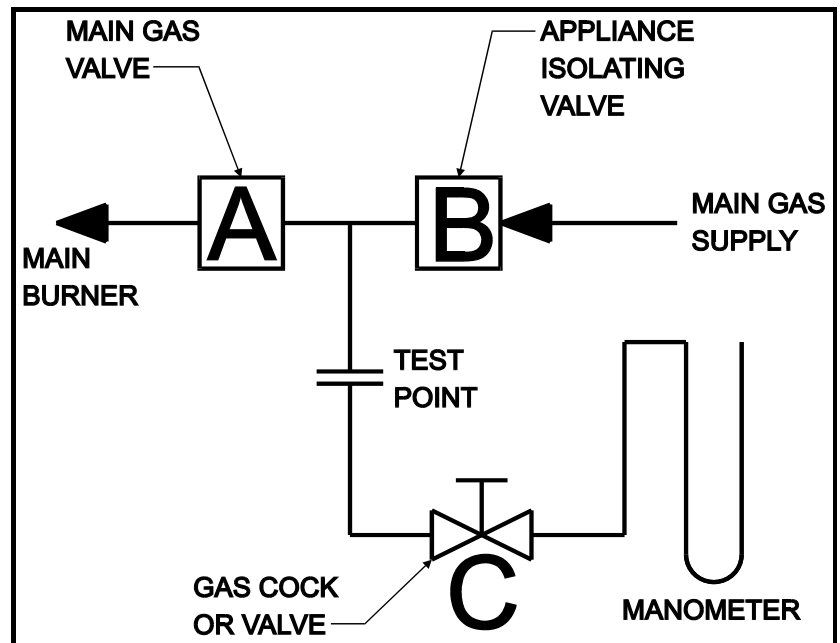

Note:-
Main Gas Supply Pressures are as follows;
Natural Gas - 20mbar

Figure 7.1 - Gas System Leak Check Diagram

TO CHECK B

- 1) Turn off the electrical power and gas supply to the appliance.
- 2) Connect the manometer assembly to test point (Fitted on the inlet to the gas valve).
- 3) With A and B closed open C and monitor manometer over a 2 minute period, a rise indicates a leak on valve B.

TO CHECK A

- 1) Open C.
- 2) Open B to produce the mains gas supply pressure between A and B.
- 3) Close B.
- 4) System may be considered sound if over a period of 2 minutes any drop in pressure is less than 0.5 mbar (0.2" wg.).

Note:- Allow a manometer stabilisation period of approximately 1 minute before each 2 minute check period. Following soundness tests close valve B and remove manometer connections and tighten test points.

Water Systems

The system **MUST** be flushed and a suitable water treatment implemented before commissioning the boiler. When installing water system pipe work, it must be self supporting and care must be taken to ensure that undue stress is avoided on the boiler flow and return connections. It is recommended that unions are fitted local to the boiler and outside of the casing, to permit future servicing requirements.

Each module is fitted with safety valve rated at 6bar. The valve discharge pipe is routed to the base of the boiler, where it must be piped to discharge via a tundish (not HHL supply) suitably located for ease of visibility.

The Fleet is designed to operate at 20°C ΔT across the flow and return. Should the flow rate drop, the boiler controls will modulate the burner to maintain 20°C ΔT . As a safety precaution, a flow switch is fitted to the boiler heat exchanger to shut the system down in the event of sudden adverse flow conditions.

Where using Hamworthy Heating Ltd pipe work kits, assembly of these is detailed in Installation manual 500005133 supplied with kit.

7.2 Checks prior to lighting the boiler

Note: Refer to Appendix A, Gas Data Tables, for maximum inlet pressure for normal operation.

7.2.1 The Following checks must be made prior to lighting the boiler;

1. Open the front cover to gain access to the boiler components. The cover is secured with a 1/4 turn latch, requiring a flat blade screw driver to operate the latch. Carefully lift off the cover to expose the boiler components and installer wiring connections.

Note: Before starting the boiler commissioning procedure verify the following;

2. Ensure that all external controls are not demanding that the boiler commences operation.

3. Ensure that the gas supply is connected, but the boiler module gas service valve(s) are **closed**, any unions or fittings are correctly tightened and test points are **closed**.

4. Check that the heating system has been flushed and refilled and that air has been purged from all high points.

5. Ensure that the system isolating valves are in the open position and that the water pressure within the heating system is correct. Minimum pressure 0.5barg.

6. Ensure that the flue ducts are correctly fitted and that they are free from obstruction. Check that the outlet terminal is located correctly and in accordance with regulations.

7. Ensure that the gas supply has been properly purged and verified for gas soundness. A purge and soundness certificate should be available from the gas pipe work installation contractor.

8. Turn on the mains gas supply. Check that sufficient gas pressure is available at the boiler, 17.5mbar Natural Gas.

10. Ensure that all electrical connections made to the boiler are correctly sized and installed. Refer to wiring diagram in Figure 9.3.1

11. Check that the boiler controls wiring has not been modified. Any modification could lead to boiler failure.

7.2.2 Gas inlet pressure test

The gas pressure must be checked at the inlet to the boiler as shown in figure 7.2.2. This is to ensure that the gas pressure is both constant and sufficient to provide full burner output. To verify this the pressure has to be taken as a static and a dynamic reading. The dynamic reading cannot be taken until the boiler has been started - refer to 7.4

The gas inlet pressure test point is at the rear of the appliance adjacent to the inlet gas connection.

A maximum difference in gas pressure of 1 mbar must not be exceeded between static and dynamic conditions.

7.3 Commissioning the Boiler

Once the preliminary checks have been completed

and the gas inlet pressure has been verified as correct, commissioning of the boiler modules may begin.

7.3 Initial Lighting

Only competent persons registered for working on non-domestic gas appliances should attempt the following operations. Before attempting to commission any boiler, ensure that personnel involved are aware of what action is about to be taken.

Record all readings for future reference on relevant commissioning sheet.

Allow system to warm up sufficiently to check operation of control thermostat.

A combustion check must be taken when first commissioning the boiler. A sampling point is provided in the boiler - refer to **section 8.6 - Combustion Checks**

7.3.1 Operational Checks

NOTE! Care should be exercised when the boiler is firing as the heat exchanger components can achieve temperatures, which could cause injury if touched.

1. Ensure that all external controls are in demand and that the gas supply to the module is isolated.

2. Switch the on/off switch located on the front panel of the boiler to the on position - see figure 8.1.

3. Start the individual boiler module using the mode button located on the fascia panel for the chosen module - detailed in **section 8.2.5 - Controls Operation.**

4. The control thermostat is set using the button (2) on the fascia as detailed in **section 8.2.5 - Controls Operation.**

5. As the gas valve is closed, the low gas pressure switch will prevent the boiler from firing and the error code 'E132' will be displayed on the screen. Refer to **section 8.2.4 of Controls Operation.**

6. If the above procedure occurs correctly, open the gas isolating valve and the fault indication will extinguish.

The boiler will commence its ignition sequence as previously described. This time, when the gas valve is energised the burner will ignite.

7. The flame ionisation signal generated whilst the boiler is firing (should be approximately 15-20µA, but not less than 3µA, can be viewed directly from the display screen. The value is set to read dc µA. Refer to **section 8.2.1.2 - Controls Operation.**

- At the end of the ignition proving period, 5 seconds, the spark ignition system will be switched off and the indicator on the control fascia extinguished.
- After a period of 15 seconds the fan will alter speed and the burner modulation will be set according to the heat load.
- If after the 5 second flame proving period the flame signal is below 3µA the boiler will shut down and attempt one restart.

NOTE: THE BOILER IS EQUIPPED WITH A RESTART FACILITY AND WILL ATTEMPT A SECOND IGNITION, DURING WHICH THE ABOVE PROCEDURES WILL BE REPEATED. AT THE END OF THE RESTART PROCEDURE, IF NO FLAME IS DETECTED AFTER THE FLAME PROVING PERIOD, THE BOILER WILL LOCKOUT. THE BOILER WILL NOT OPERATE UNTIL THE LOCKOUT HAS BEEN MANUALLY RESET.

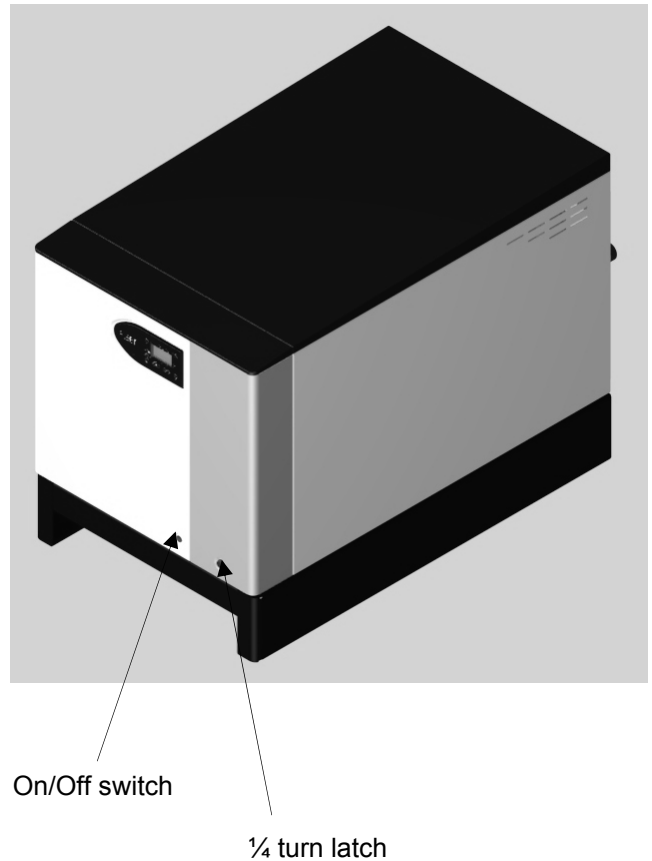

Fig 7.2.1 - On/Off switch

7.4 Ignition Controller Check.

1. With the burner firing, the flame signal should be at least 3µA. Refer to **Figure 8.2.9 - Maintenance functions**. To check for correct operation of the ignition controller, close the gas valve. The boiler should shutdown after approximately one second and attempt a re-ignition. Check that the flame has been extinguished

2. Alternatively, the flame probe lead can be removed from the end of the flame probe, with the same result.

7.5 Gas Supply Pressure Check.

1. When the boiler modules have been checked for correct operation the gas supply pressure should be checked. This should be done with all modules firing.

- For Natural Gas, a nominal gas inlet pressure of 20mbar measured at the rear of the boiler is required, with a maximum inlet pressure of 25mbar.

7.6 Combustion Checks

“The boiler modules are factory pre-set, but, site checks must be done to confirm correct performance.”



Figure 7.6 - Combustion Analyser Probe Setting

1. Remove the flue gas sampling plug from the flue collector sump, accessible from the front of the boiler and insert the combustion analyser probe in the flue at the analysis point .

2. Ensure that an insertion distance of 50mm is set on the combustion analyser probe.

NOTE: THIS DISTANCE MUST BE SET TO ENSURE ACCURATE ANALYSIS OF FLUE GASES.

3. Insert probe horizontally into the flue collector sump until depth stop is met.

(Note: readings taken with front cover removed and 50mm probe insertion CO = < 80 ppm).

4. If combustion is outside of the ranges defined below the factory sealed valves may be adjusted using the following procedure .

Models - F175H - F350H



High Fire Target **Nat Gas - 9.2% ±0.25% CO₂**

If combustion level is outside of this range use the Cross Head Throttle Screw to adjust the mixture.

THIS SETTING MUST BE CORRECT BEFORE CONTINUING To increase the CO₂ level, turn the adjustment anti-clockwise.

Figure 7.6.1- Adjusting gas valve throttle

Models - F175H- F350H

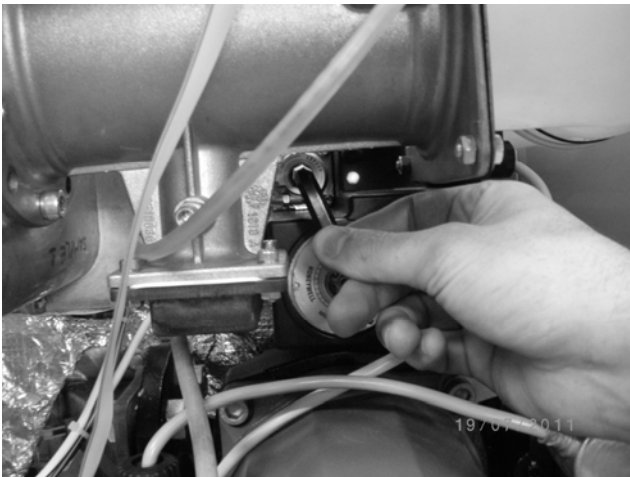

Low Fire Target **Nat Gas 10.0% ±0.25% CO₂**

If combustion readings are outside target range use Torx Bit to make adjustments

To increase the CO₂ level, turn the adjustment clockwise.

Figure 7.6.3 - Adjusting gas valve offset

Fig 7.6.1 - Combustion settings

5. Energise electrical supply and start the boiler module. The burner will ignite and run at 100% modulation.
6. Monitor the combustion readings on the combustion analyser at both Maximum and Minimum firing rates - refer to section 8.2.8.2 - Controller Stop function

***Figure must not exceed 100ppm under normal operating conditions.
If combustion readings fall within the required range the boiler module is set and operating correctly. If the combustion readings fall outside the required range the burner settings will require adjustment.**

CONTACT HAMWORTHY HEATING TECHNICAL DEPARTMENT FOR FURTHER DETAILS

7. Shut down the boiler and isolate from the electrical supply. Remove instrumentation and replace test points and plugs.
8. Refer to **section 8.1 - Controls Operation**, to adjust the relevant boiler settings specific to the installation

7.7 Setting the flow rate to achieve 20°C ΔT

Before commissioning is complete, the flow rate must be checked and adjusted. A ball valve is located on the boiler return pipe, prior to the pump, and controls the flow through the boiler. Using the boiler flow and return temperature sensors

visible on the display via the LMU programme. This **MUST** be carried out with the boiler running at **maximum** firing rate.

The 20°C ΔT condition across the boiler must be set as follows;

- 1 Run boiler at maximum rate.
- 2 Monitor flow temperature (displayed on main screen of HMI).
- 3 As boiler flow temperature rises, between 60°C & 80°C , press info button (to enter information mode) then hold down up/down arrows for 3 seconds (to enter extended information mode) use + button to scroll to b1 which displays boiler return temperature.
- 4 Within the case, locate the ball valve on the return pipe of the boiler, and then adjust to give 20°C differential between flow and return temperature. Opening the valve will decrease the differential/closing the valve will increase the differential.

Press mode button to exit back to main screen and check flow temperature. It may be necessary to repeat the sequence several times to ensure an accurate 20°C delta T is set.

Note.

E164 error code = flow switch interrupt (too little/no flow through boiler).

E154 error code = Delta T supervision active (too little flow through boiler).

7.8 User Instructions.

When the boiler is fully commissioned, the owner or their representative should be made aware of the lighting-up and operating instructions. A practical demonstration should be given describing each functional step. This Installation and Commissioning guide, the servicing instructions manual and the user's instructions should then be handed over and be kept in a safe place for future reference.

8 CONTROLS OPERATION

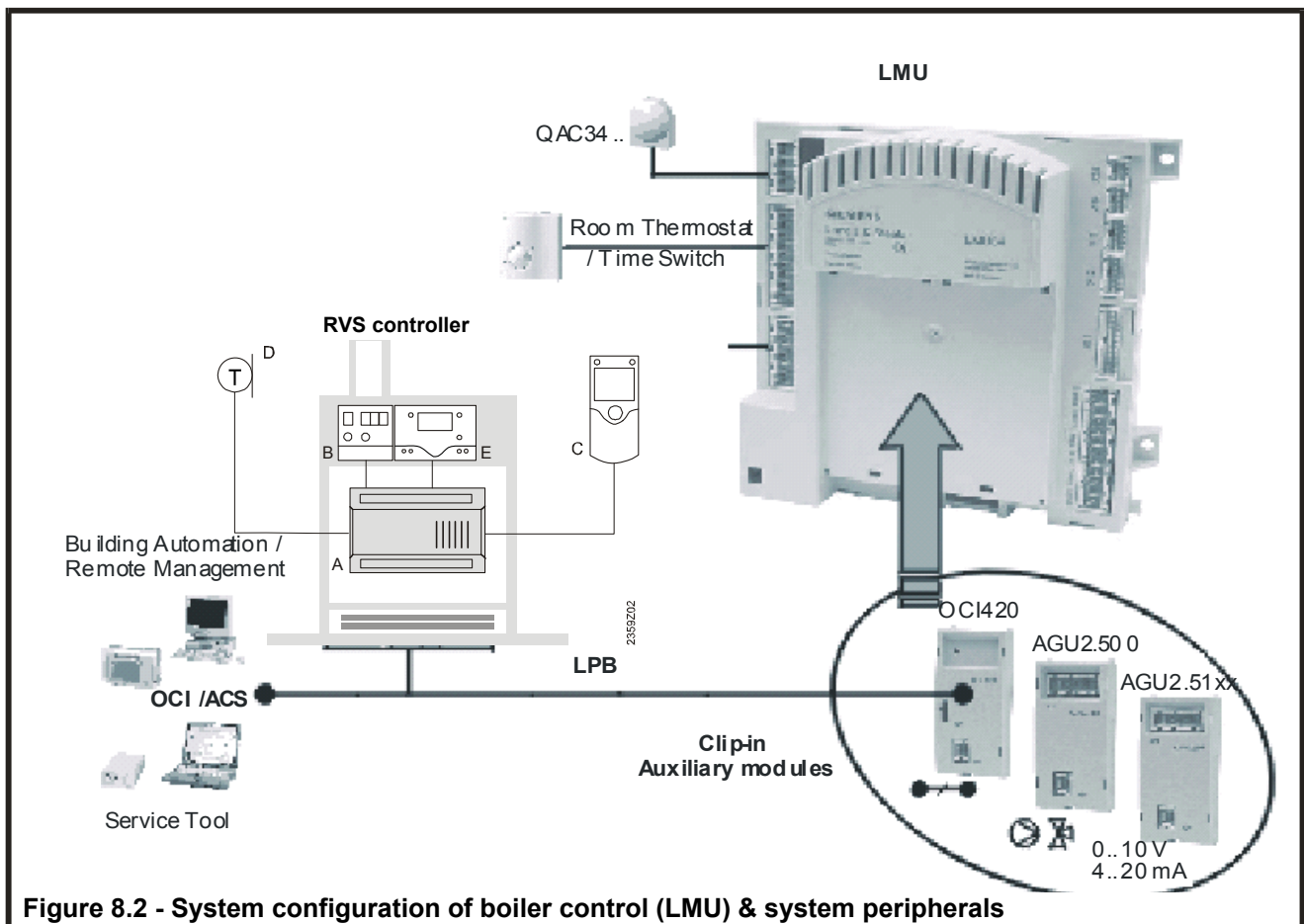

Figure 8.2 - System configuration of boiler control (LMU) & system peripherals

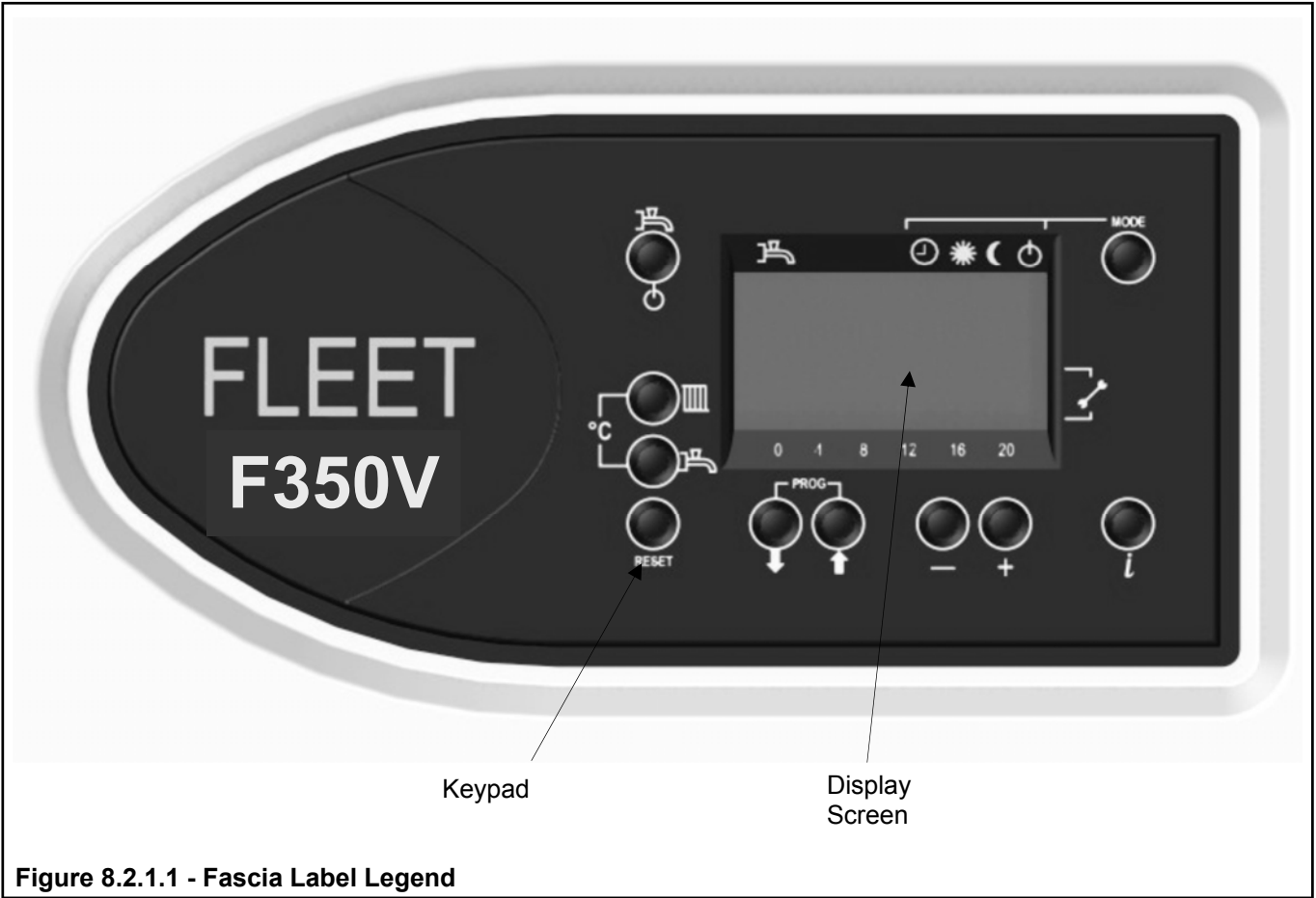

Figure 8.2.1.1 - Fascia Label Legend

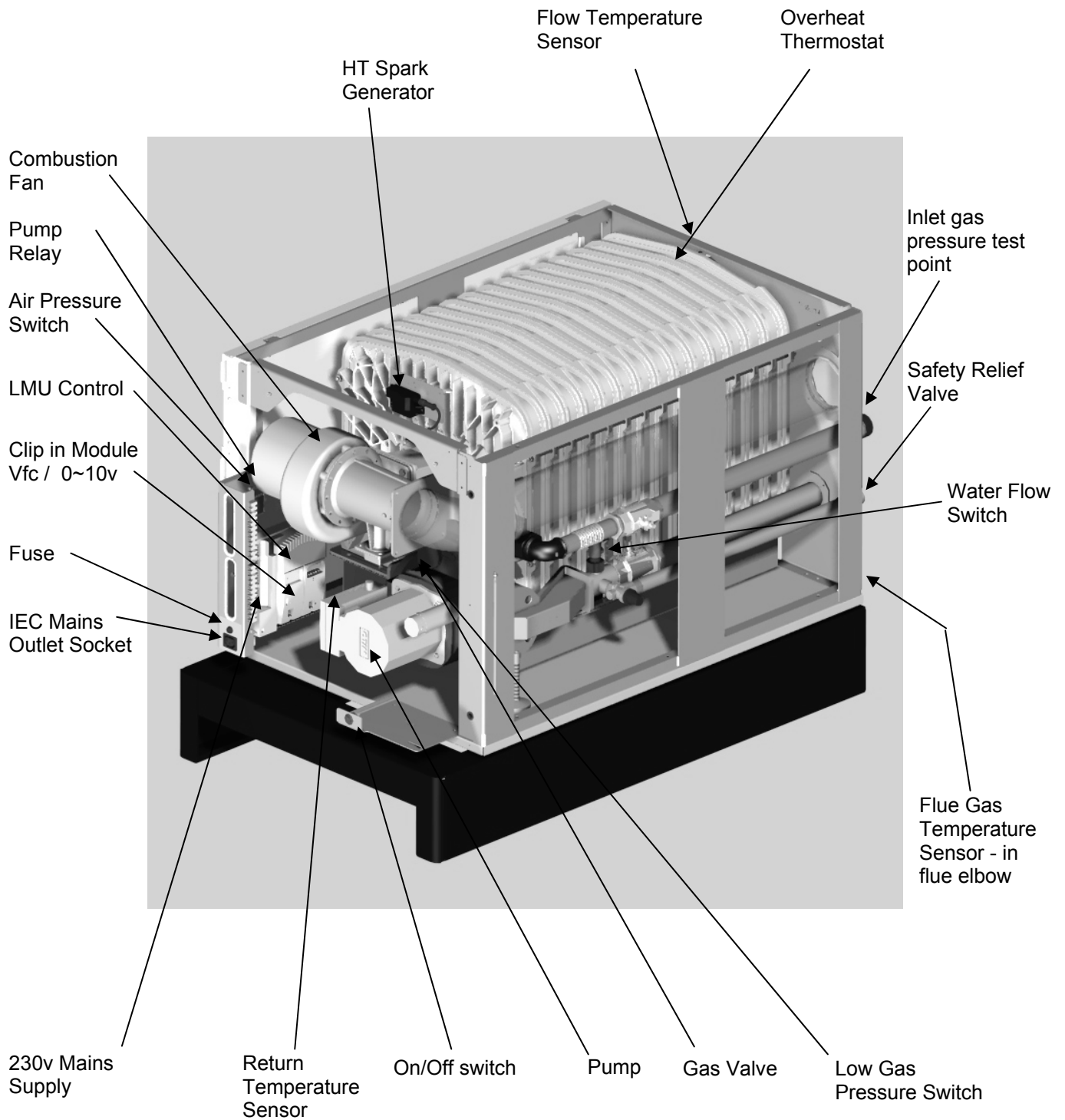









Figure 8.1.6 - General Overview of Boiler Controls

8.2.1 - Info button - refer to figure 8.2.1.1









A change on the information level can be made at any time by pressing the Info button.

Additional pushes of the Info button will deliver the following data sequence provided by the information level.

	dhw temperature - not used
	Water Pressure
X.	Operating phase - refer to section 8.2.15
	Outside temperature
	Error code - refer to section 8.2.14
	Boiler temperature
 	Press one of these buttons to return to the default display

Extended Info mode - when on the information level, extended info mode levels b, c & d can be displayed.

Refer to Figure 8.2.2

 	Press both line selection buttons simultaneously for at least 3 seconds
 	Press one of these buttons to select the required display level
 	Press one of these buttons to select the required display value of the level
	Press the Info button to switch to the info display
 	Press one of these buttons to return to the default display



























Button	Operation	Function
	Lockout reset	Resetting the LMU
	Enable dhw mode	dhw on/off - not used
	Enable heating circuit mode	selection of operating mode:
		Automatic operation
		Continuous 'Normal' Operation
		Continuous 'Reduced' Operation
		Standby
	Heating circuit temperature setpoint	Adjustment of boiler or room temperature setpoint.
	dhw temperature setpoint	Adjustment of dhw temperature setpoint - not used
 	Line selection (down / up)	Selection of operating parameter
 	Adjustment of settings	Adjustment of parameter settings
	Information	Select information display screens
 	Enable Maintenance mode	Press buttons simultaneously to select

Figure 8.2.1.2 - Info display parameters

The parameters of groups **b,C** and **d** can only be displayed

Display level	Name of LMU... variable	Description		
General information (Enduser level)				
Temperatures (Service level) ¹⁾				
b 0	DiagnoseCode	LMU...-internal software diagnostic code		
b 1	TkRuec	Boiler return temperature		
b 2	Tbwlst2	DHW temperature sensor 2		Not used
b 3	Tabgas	Flue gas temperature		Not used
b 4	TiAussen	Outside temperature		
b 5	TaGem	Composite outside temperature		
b 6	TaGed	Attenuated outside temperature		
b 7	Tvlst	Flow temperature AGU2.500...		
b 8/ b9	Reserved			
Process values (Service level) ²⁾				
C 0	Reserved			
C 1	IonStrom	Ionization current		
C 2	Geb1_Drehz	Fan speed		
C 3	Geb1_PWM_AusAkt	Current fan control (PWM)		
C 4	RelModLevel	Relative output		
C 5	Pumpe_PWM	Pump setpoint (PWM)		Not used
C 6	ek0	Control differential		
C 7/ C8/ C9	Reserved			
Setpoints (Service level) ³⁾				
d 0	Reserved			
d 1	Tsoll	Setpoint of 2-position or modulating controller (PID)		
d 2	TkSoll	Current boiler temperature setpoint		
d 3	TsRaum	Room temperature setpoint		
d 4	TbwSoll	DHW temperature setpoint		Not used
d 5	PhzMax	Maximum degree of modulation in heating mode		
d 6	NhzMax	Maximum speed at maximum output in heating mode		
d 7/ d8/ d9	Reserved			

- Note ¹⁾
- 1 Press Info button 
 - 2 Press buttons for at least 3 seconds 
 - 3 Choose the relevant parameter with buttons 
- Note ²⁾
- 1 Press Info button 
 - 2 Press buttons for at least 3 seconds 
 - 3 Press button 
 - 4 Choose the relevant parameter with buttons 
- Note ³⁾
- 1 Press Info button 
 - 2 Press buttons for at least 3 seconds 
 - 3 Press button twice 
 - 4 Choose the relevant parameter with buttons 

Note after about 8 minutes, the display will automatically change to the default display.

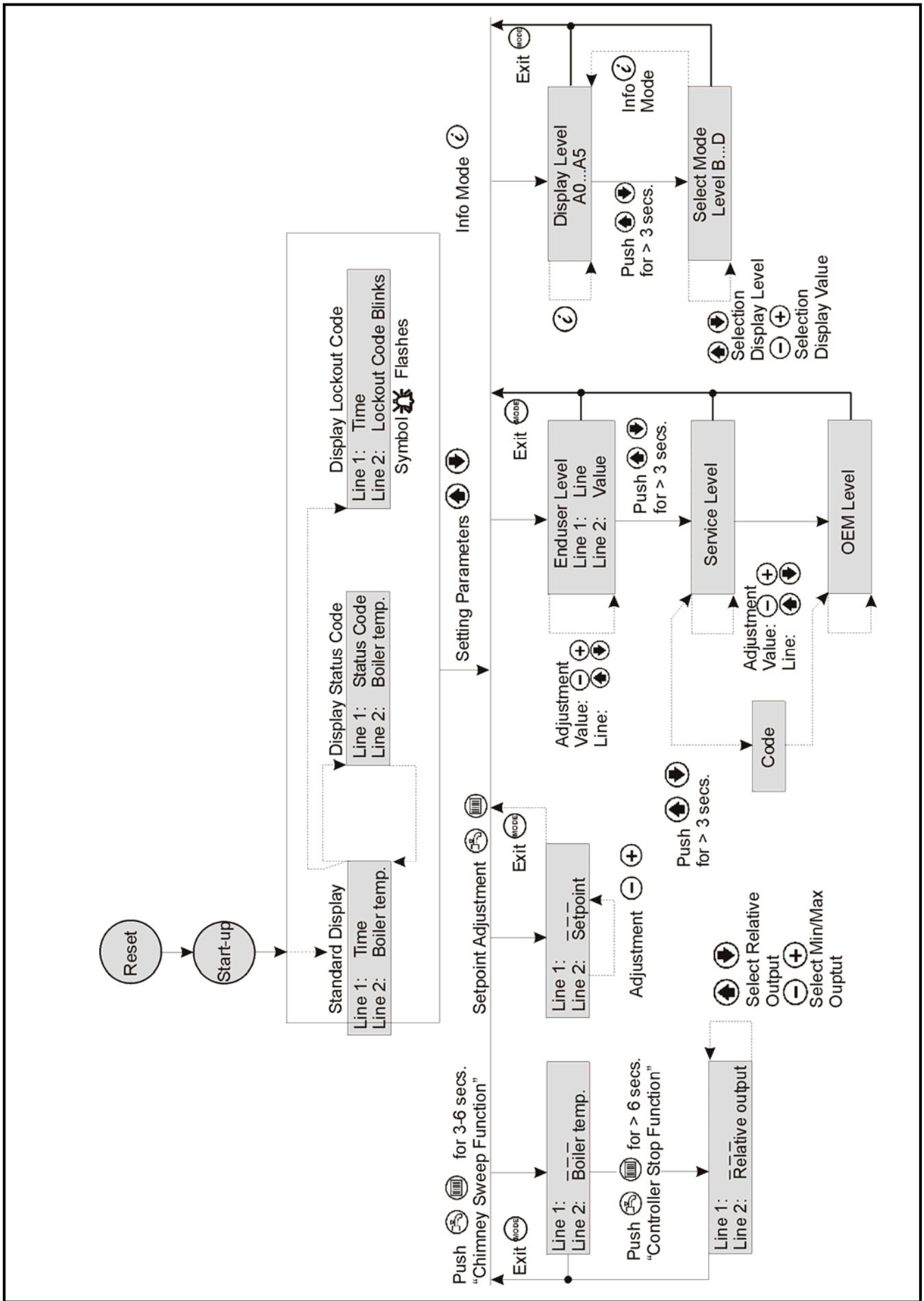

Figure 8.2.1.3 - Operation and display philosophy

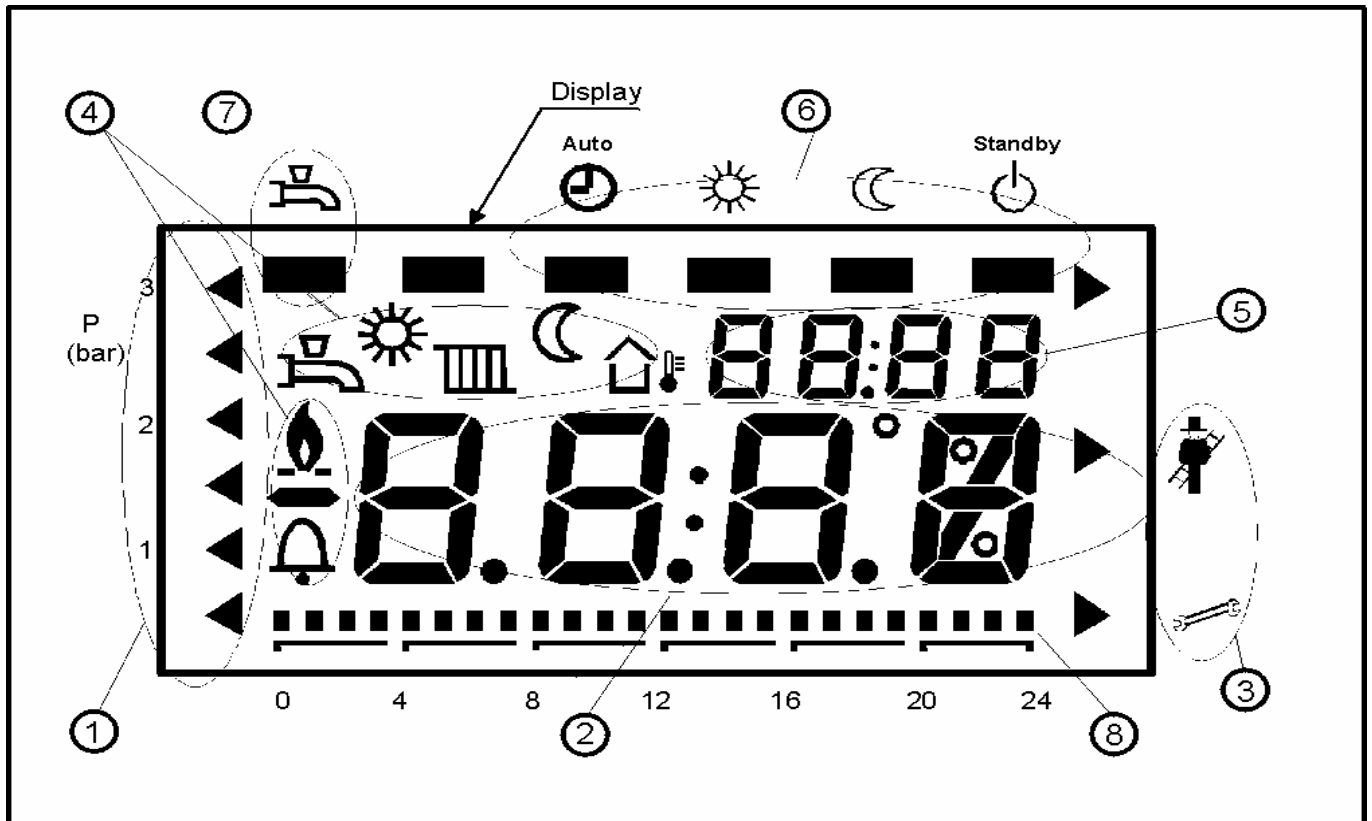













Figure 8.2.2 - Screen Legend

Character	Display	Function
①	Water pressure sensor signal	Display of water pressure (6 pointers) in increments of 10bar
②	Display (2) 4 x 7 large segments	Display of current value
③	Maintenance indicator flashing	Upper arrow - Chimney Sweep active Lower arrow - Controller Stop active
④	Display symbols	Meaning of symbols:  Display of dhw temperature or dhw heating active – not used  Display of boiler or room temp. set-point, or space heating active.  Display of outside temperature.  Operational level 'Normal'  Operational level 'Reduced'  Display of flame  Display of fault
⑤	Display (1) 4 x 7 small segments	Display of time of day, parameter settings or error code.
⑥	Operating mode of heating circuit	Operating mode is, or changes to:  Automatic  Continuous 'Normal' operation  Continuous 'Reduced' operation  Standby
⑦	Operating mode of dhw.	On or Off - not used
⑧	Time bar	Display of time program of heating circuit

8.2.3 - Default Display

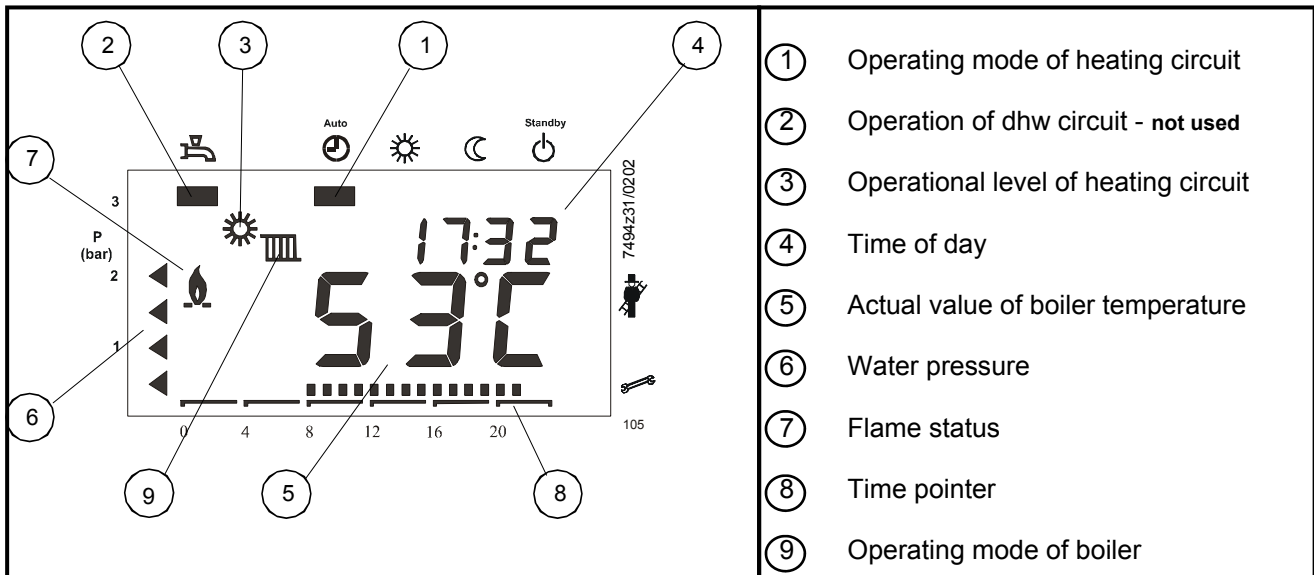

Figure 8.2.3.1 - Default display

If no button is pressed for about 8 minutes, the screen will automatically return to the default display.

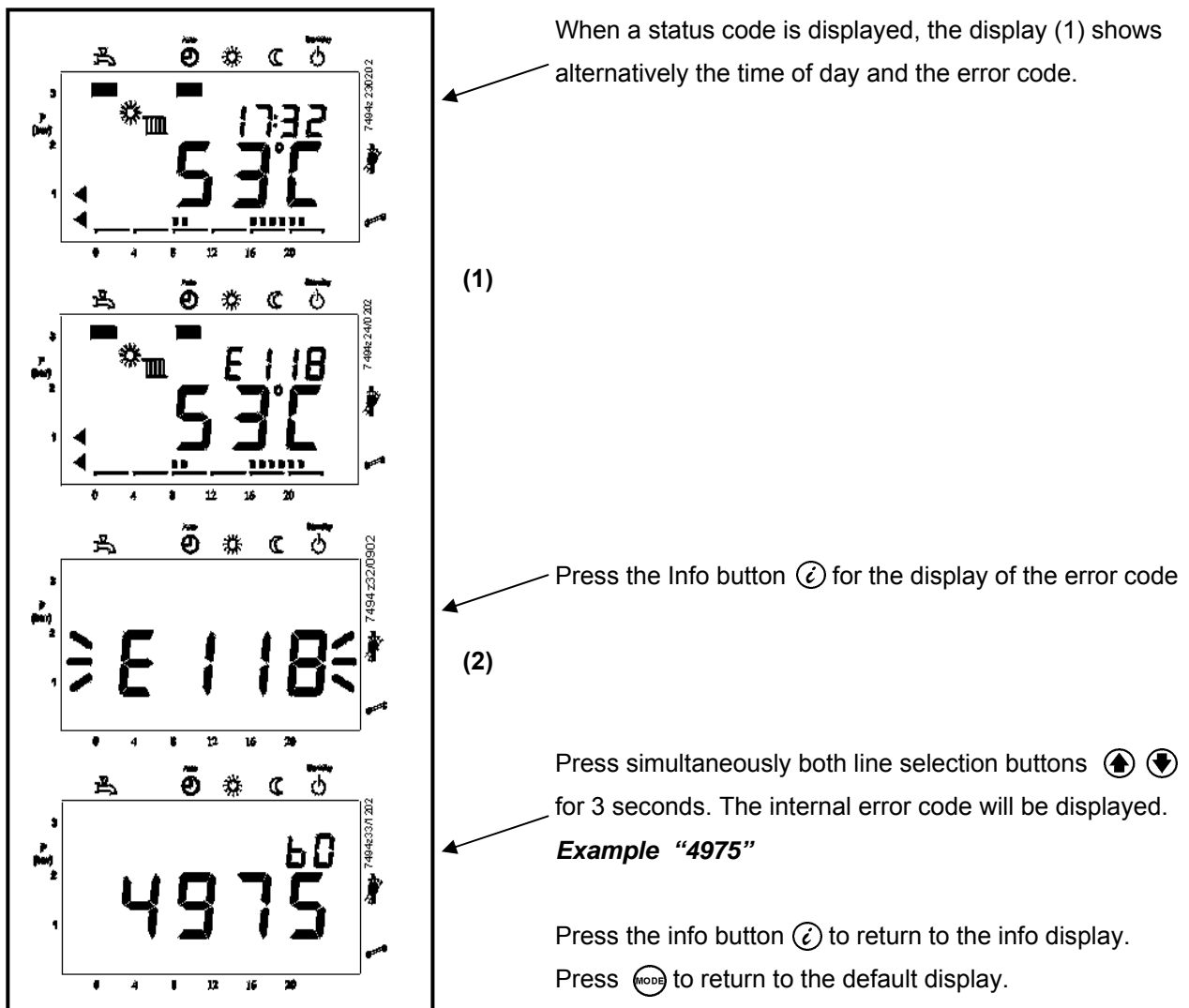

Figure 8.2.3.2 - Display of Status Code

8.2.4 - Lockout Display

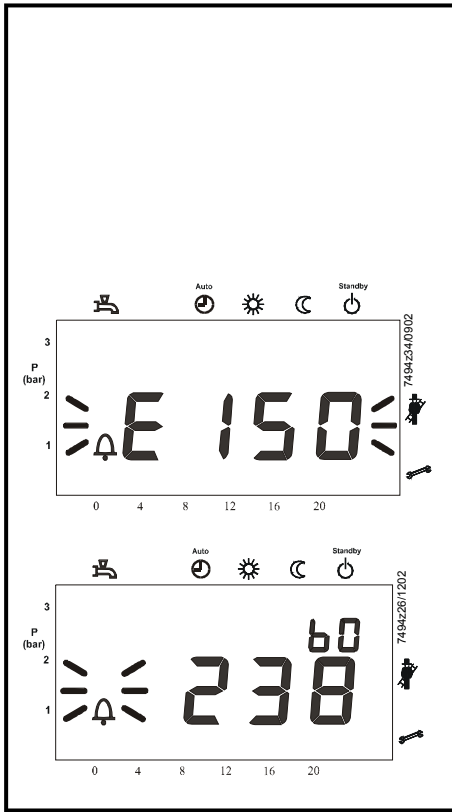

Figure 8.2.4 - Display of lockout code

In the case of a lockout code, the error code display flashes together with an 'Alarm symbol';

(1) The LMU will go to lockout

Example: "E150"

(2) Press the Info button (i) to switch to the error code

Press both line selection buttons (up/down) simultaneously for 3 seconds. The internal error code will be displayed

Example "238"

Press the Info button (i) to switch to the Info display

Press (MODE) to return to the default display

Note: After rectification of the fault, press the reset button (RESET) (>0.6 seconds) to reset the LMU.

8.2.5 - Adjusting the heating circuit setpoint temperature

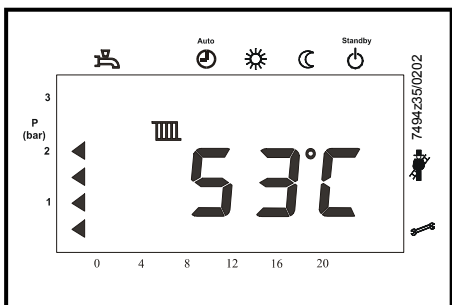

Figure 8.2.5 - Heating circuit setpoint temperature

Press the flow temperature button (thermometer icon) to adjust the heating circuit setpoint

(1)

Press (-) (+) to adjust the required setpoint

Press (MODE) to return to the default value









Changes will be stored.

The room temperature setpoint or boiler temperature setpoint will be changed depending on the plant's configuration (with or without outside sensor).

If no button is pressed for about 8 minutes, the screen will automatically return to the default display. Changes will be stored.

8.2.6 - Parameter settings for the Enduser

The boiler is supplied with default settings. These must be modified to suit individual Enduser needs.

 	Press one of the line selection buttons. This will take you to programming level <<Enduser>>
 	Press the line selection button to choose the relevant line. The display shows <<Pxxx>>
 	Adjust the required value with one of these buttons. The adjustment is stored as soon as you change to some other line (to alter individual items, a change of parameter is required). The Enduser Parameter list details all possible settings.
	Press button to leave the programming level. Changes will not be stored
	Press the Info button to leave the programming level. Changes will be stored

Note: If no button is pressed for about 8 minutes, the screen will automatically return to the default display. Changes will not be stored. When switching to another level, changes will be stored.

Line	Function	Range	Unit	Resolution	Default value
<i>Time of day</i>					
1	Time of day	0...23:59	h / min	1 min	---
<i>Setpoints</i>					
5	Reduced room temperature setpoint «TrSollRed» or (reduced boiler temperature setpoint «TvSollRed») (When using an additional room unit, line 5 will be hidden)	TRF...TRN	°C	0.5	16.0
<i>Time program HK1 (heating circuit 1)</i>					
11	Time program HC1 switch-on time 1 st period	00:00...24:00	hh:mm	10 min	06:00
12	Time program HC1 switch-off time 1 st period	00:00...24:00	hh:mm	10 min	22:00
13	Time program HC1 switch-on time 2 nd period	00:00...24:00	hh:mm	10 min	24:00
14	Time program HC1 switch-off time 2 nd period	00:00...24:00	hh:mm	10 min	24:00
15	Time program HC1 switch-on time 3 rd period	00:00...24:00	hh:mm	10 min	24:00
16	Time program HC1 switch-off time 3 rd period	00:00...24:00	hh:mm	10 min	24:00

Figure 8.2.6 - Overview of Enduser parameters

8.2.7 - Start-up / initialisation

On startup after power-On, or after a lockout reset, the setpoints will be initialized.

These setpoints apply until a first adjustment is made (e.g. via the screen display or PC parameterization):



After a readjustment, these values will be overwritten with the new value and permanently stored in the LMU.

When a new startup is made, or after power-On, the previous settings will be stored in the LMU.

Also, the software version number of the operator module and that of the connected type of LMU... will be delivered.

8.2.8.1 - Chimney Sweep function

The chimney sweep function enables the boiler to be started up in heating mode by pressing both buttons simultaneously for more than 3 seconds but for no more than 6 seconds.

On the   display, the upper arrow of the maintenance function flashes and the currently selected temperature appears. This function serves for making measurements on the boiler. When the chimney sweep function is activated, the boiler will deliver maximum output until the limit thermostat cuts out.



To ensure maximum supply of heat, the chimney sweep function generates the forced signal for heat supply.

During the time that the Chimney Sweep is activated, an appropriate status code is delivered.



To close the function, press button





8.2.8.2 - Controller Stop function

The controller stop function enables the boiler's heat output to be adjusted manually in heating mode by pressing both buttons   simultaneously for more than 6 seconds.

On the display, both arrows of the maintenance function flash and the currently selected temperature appears and the display shows the adjusted relative boiler output.

The function serves for making measurements on the boiler and allows the boiler output to be increased / decreased by pressing buttons  .



Minimum and maximum output can be directly selected by pressing the line selection buttons  .

Note: - If the controller stop function is triggered via PC tool ACS420, the current setpoint of burner output will appear on the display, but the settings are locked.

To close the function, press button .

8.2.8.3 - Time of day function

To ensure that this function operates, the time of day and time settings must be correctly set. Refer to section, Parameter settings for Enduser, to setup the program.

Note:- each time button   is pressed during the time setting, the seconds are set to 0 and the clock continues to run while making the setting.

8.2.9 - Heating circuit operating modes

The control provides 4 different heating circuit operating modes for LMU... heating circuit 1. They can be directly selected depending on the requirements - see figure 8.2.9

The operating modes are selected by pressing button .

On the LCD, a pointer below the respective symbol points to the selected heating circuit operating mode.

8.2.10 - Error code display

In the event of a nonvolatile LMU... lockout position, fault is continually displayed. In addition, the diagnostic code on the display flashes (refer to figure 8.2.4 and table 8.2.10).

To cancel the lockout position, press lockout reset button  for at least 2 seconds.

8.2.11 - Display of operating phases (display level A4)

The operating phases according to the LMU... 's sequence diagram can be displayed (display level A4 press Info button 3 times).

Assignment of the display code and the LMU... 's phase designation is as shown in figure 8.3.11





Operating mode	Designation	Effect of selection
	Automatic operation	Heating circuit 1 (HC1) according to time switch program 1
	Standby	Heating circuit 1 switched off Frost protection functions active
	Continuous 'Normal' operation	Heating circuit 1 continuously on according to the adjusted nominal room temperature setpoint or heating circuit setpoint
	Continuous 'Reduced' operation	Reduced room temperature set point or heating circuit frost protection setpoint

Figure 8.2.9

8.3 - Functions

8.3.1 Frost Protection

Note: - to access this function, the circulating pump must be wired to the LMU through a suitable contactor.

There are two levels of frost protection available dependent on the sensor options used.

1st stage - When the boiler water temperature is below 5°C, the burner and the heating pump are switched on. When the temperature increases and exceeds 15°C, the burner stops and the pump continues for the duration of the pump overrun.

2nd stage - This additional function uses the outside air temperature (if a sensor has not been fitted, the function is blocked) and provides three levels of activation.

- If the outside temperature is less than or equal to -5°C, the pump operates continuously
- If the outside temperature is between -4 & 1.5°C, the pump operates for 10 minutes every 6 hours.
- If the outside temperature is greater than 1.5°C, the pump is switched off.

Note:- any demand for dhw is given priority.

Should protection be required for the building fabric, then a QAA73 programmable room sensor must be used to maintain the internal building temperature.

8.3.2 Anti Legionella

To prevent the development of pathogenic bacteria in the domestic hot water tank during prolonged shut downs or low storage temperatures, the dhw must be heated once a week to a temperature greater than 60°C.

The anti legionella function heats the dhw once a week on Monday, after the first load, to 65°C.

8.3.3 Pump overrun

When the heating mode ends, the heating circuit pump remains on for a period (depending on the settings used - QAA73: 544).

In dhw systems, when the dhw heating period ends, the heating pump remains on until the return temperature drops below 70°C. During this period, the dhw selector valve (if fitted) is in the open position.

8.3.4 Pump or selector valve kick

If either the heating circuit pump or dhw selector valve have not been activated for more than 24hours, then during an off period the pump or valve is activated for 5 seconds.

8.3.5 Boiler overheat protection

The boiler flow sensor in combination with the return sensor, provide overheat protection as follows:

- If the first level temperature is exceeded, a fault code is displayed.
- If the second level temperature is exceeded, an alarm code is displayed and the boiler will switch off. The boiler must be reset to restart.

To restart the boiler, the temperature must fall, accordingly the fan and pump will continue to operate until the boiler heat exchanger temperature drops.

Additionally, should the ΔT across the boiler heat exchanger exceed 25°C, the burner will reduce output to minimum rate. Should the ΔT exceed 30°C, the burner will shutdown.

8.3.6 Anti-cycling

Dependent on the installation and the minimum firing rate of the boiler, the control monitors the heating temperature curve and will hold off a boiler from firing and thus reduce the number of operations.

8.3.7 Automatic summer / winter switching

Note: - This function is only available when an outside sensor is fitted.

The automatic summer/ winter switching function enables the summer mode to be switched to winter mode (vice versa) throughout the year, without the need for manual intervention.

The heating is shut down when the average outside temperature measured over the preceding 24hours is greater than 1°C above the set point (20°C).

The heating is automatically started up again when the average outside temperature measured over the preceding 24hours is less than 1°C below the lower limit of the hysteresis threshold of the set point (18°C).

Note: - The switch over setting is set to 19°C and can only be changed using the QAA73 room sensor.

The automatic mode must obviously be activated on the boiler as well as on the QAA73, for the function to operate. The function is automatically activated by a default setting in the QAA73.

8.3.8 - Start-up / initialisation

On startup after power-On, or after a lockout reset, the setpoints will be initialized.

These setpoints apply until a first adjustment is made (e.g. via the display or PC parameterization):

After a readjustment, these values will be overwritten with the new value and permanently stored in the LMU.

When a new startup is made, or after power-On, the previous settings will be stored in the LMU.

Also, the software version number of the operator module and that of the connected type of LMU... will be delivered to the display.

Figure 8.2.10 LMU Error Codes

Error code	Internal Error-Code	Potential cause	Actions
0		No entry in code	
10		Fault outside sensor	
20	142	Short Circuit Boiler Flow Sensor	Check temp sensor in water flow pipe & replace if necessary
	143	Open Circuit Boiler Flow Sensor	Check connections to temp sensor in water flow pipe Check temp sensor in water flow connection & replace if necessary
28		Fault flue gas sensor	
32		Fault flow temperature sensor 2	
40	144	Short Circuit Boiler Rtn Sensor	Check temp sensor in water rtn pipe & replace if necessary
		Open Circuit Boiler Rtn Sensor	Check connections to temp sensor in water rtn pipe Check temp sensor in water rtn connection & replace if necessary
50		Fault DHW temperature sensor 1	
52		Fault DHW temperature sensor 2	
61		Fault room unit 1	Check room device
62		Wrong room unit 1 or wrong radio clock connected	Connect compatible room control unit
77		Fault air pressure sensor	
78		Fault water pressure sensor	
81	518	LPB Short Circuit or no power supply	Check connections to clip in (switch off and isolate boiler before working on mains wiring)
82		Address collision on LPB...	Check addresses of connected modules
91		Data overflow in EEPROM	
92		Hardware fault in electronics	
95		Invalid time of day	Set correct time
100		2 clock time masters	
105		Maintenance message	P629 to reset : change from 0 to 1
110/111		Limit thermostat has cut out	Allow the boiler to cool and reset thermostat Investigate cause of overheating (see section 9.3)
113		Flue gas supervision equipment has cut out	
117		Water pressure too high	
118		Water pressure too low	
119		Water pressure switch has cut out	Check water pressure
128		Loss of flame during operation	Check connections to flame probe Investigate flame probe condition Check combustion when boiler is firing
130		Flue gas limit temperature exceeded	
132		Safety shutdown	Check gas pressure Check flue & condensate trap for blockages Check safety switches
133		No flame on completion of safety time	Check operation of gas valve. Check spark igniter
134		Loss of flame during operation	
140		Inadmissible LPB segment number/device N°	
148		Incompatibility LPB... interface / basic unit	
151	552	Relay clip in faulty	Check connections to clip in Check and replace clip in module (switch off and isolate boiler before working on mains wiring)
152		Fault in connection with LMU settings	
153		LMU has locked out	Press reset button (code appears if reset button is pressed when there are no faults)
154		Flow Problems	Check water flow through the boiler & Check the pumps
160		Fan speed threshold not reached	Check obstructions in fan, burner & flue. Check non-return valve operates Check heat exchanger for debris
161		Maximum fan speed exceeded	Check parameters
162		Fault air pressure switch (does not close)	
164		Fault heating circuit flow switch / pressure switch	
166		Fault air pressure switch (does not open)	
180		Chimney sweep function active	
181		Controller stop function active	
183		LMU... in parameter setting mode	

8.3.9 - BMS 0~10v DC control of LMU

Before programming changes are made, ensure the boiler is set to standby mode.

The following parameters need to be changed on the boiler LMU when a BMS 0-10 V signal is being used to control the boiler modules directly. All parameters can be changed using the keypad on the boiler display panel or via the computer link using the Siemens software.

Press and hold both up and down arrow keys for at least five seconds to enter advanced parameter list H90 displayed top right of HMI screen.

Use either up or down arrow key to scroll through the parameter list and stop at H618 - Default value is 0

Two options for control are available :

Option 1 (preferred option for multiple boilers on a modulating 0-10V signal controlling the load)

To enable 0-10v control over the boiler power range, change the setting by using the + or – key and set value to 5. Press mode button to store change and return to home screen.

Option 2 (if the 0-10V signal is only being used to enable the boilers and is not modulating)

To enable 0-10v control over the boiler temperature set point, change the setting by using the + or – key and set value to 4. Press mode button to store change and return to home screen

Press and hold both up and down arrow keys for at least five seconds to enter advanced parameter list H90 displayed top right of HMI screen.

Use either up or down arrow key to scroll through the parameter list and stop at H622 - Default value is 80

Change this value to match the required flow temperature set point at maximum (10v) e.g. 80 = 80°C max set point. Press mode button to store change and return to home screen

0-10v signal wiring can now be connected to connections 15 and 16 of the terminal rail to control the boiler.

Boiler	PC	Req'd setting	Function
618	526	4	0–10 V - temperature
618	526	5	0–10 V - load (preferred option for modulating load)
622	528	As req'd (80°C)	Max temp = 10 V
623	529	As req'd (20%)	Min % load = 20 %

It may be necessary, depending on the operating temperature required, to raise the maximum operating temperature possible from the individual boiler modules. As standard the boiler modules leave the factory with a maximum operating temperature of 85°C. Where a higher operating temperature is required the following parameter change must be made.

505 181 As req'd (90°C) Max operating temp.

8.3.10 - Access to LMU Fault Log

The LMU control retains historical fault information of the last 6 faults, as read only via the Engineer level access.

The current fault relates to the actual lockout at the time of the visit. Once reset, the current fault becomes the 1st fault and the remaining history is shifted back to the 5th fault, losing the previous 5th fault history.

The Albatros code is the 'E' display code supported by the internal code

Note :

When connecting to a QAA73 unit refer to Hamworthy OEM manual 500001140

When connecting to a Merley control unit refer to Hamworthy OEM manual 500001210

Figure 8.3.10—LMU Fault Log

No QAA73... AGU2.310	Function	Level QAA73... AGU2.310
700	1st past value of lockout code counter	Engineer *
701	1st past value of lockout phase	Engineer *
702	1st past value of internal diagnostic code	Engineer *
728	1st past value of ALBATROS error code	Engineer *
703	2nd past value of lockout code counter	Engineer *
704	2nd past value of lockout phase	Engineer *
705	2nd past value of internal diagnostic code	Engineer *
729	2nd past value of ALBATROS error code	Engineer *
706	3rd past value of lockout code counter	Engineer *
707	3rd past value of lockout phase	Engineer *
708	3rd past value of internal diagnostic code	Engineer *
730	3rd past value of ALBATROS error code	Engineer *
709	4th past value of lockout code counter	Engineer *
710	4th past value of lockout phase	Engineer *
711	4th past value of internal diagnostic code	Engineer *
731	4th past value of ALBATROS error code	Engineer *
712	5th past value of lockout code counter	Engineer *
713	5th past value of lockout phase	Engineer *
714	5th past value of internal diagnostic code	Engineer *
732	5th past value of ALBATROS error code	Engineer *
715	Current value of lockout code counter	Engineer *
716	Current value of lockout phase	Engineer *
717	Current value internal diagnostic code	Engineer *
733	Current value of ALBATROS error code	Engineer *

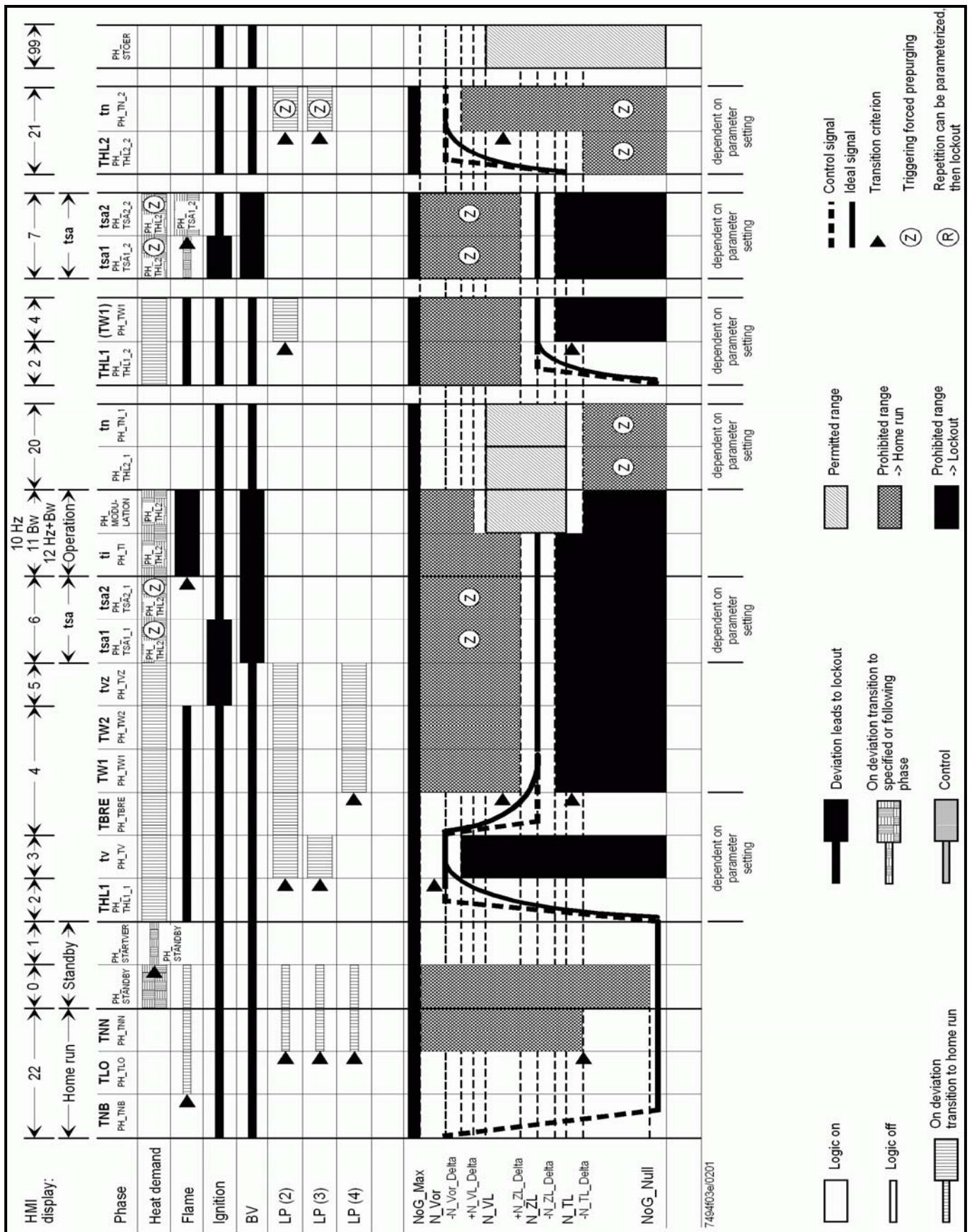

Figure 8.3.11 - Operating phases

Display	Meaning	Internal operating phases of the LMU...
00	Standby (no demand for heat)	PH_STANDBY
01	Prevention of startup	PH_STARTVER
02	Fan runup	PH_THL1_1 PH_THL1_2
03	Prepurging	PH_TV
04	Waiting time	PH_TBRE PH_TW1 PH_TW2
05	Preignition time	PH_TVZ
06	Safety time, constant	PH_TSA1_1 PH_TSA2_1
07	Safety time, variable	PH_TSA1_2 PH_TSA2_2
10	Heating operation	PH_TI PH_MODULATION Heating mode
11	DHW operation	PH_TI PH_MODULATION DHW mode
12	Parallel operation of space heating and DHW heating	PH_TI PH_MODULATION Heating and DHW mode
20	Postpurging with the last control of operation	PH_THL2_1 PH_TN_1
21	Postpurging with control of prepurging	PH_THL2_2 PH_TN_2
22	Home run	PH_TNB PH_TLO PH_TNN
99	Lockout position (display of the current error code)	PH_STOER

Note: -If operating phases are passed very quickly or skipped, the relevant display code will not appear.

Figure 8.3.12 - Operating phases

9.0 FAULT FINDING

The Fleet boiler is equipped with full self-diagnostic fault indication, with faults allocated a code, which is displayed (flashes) on the display - refer to **section 8.3.9 - Maintenance functions**.

The common fault codes are detailed in **section 8.3.9 - Maintenance functions**. Fault codes not detailed in this manual should only be investigated by an Engineer.

Should a fault code appear which cannot be reset, or a fault code repeatedly occurs, contact Hamworthy Heating for assistance. Do not continue to operate or use the boiler as this may cause damage to the controls.

9.1 Safety Temperature Limiter (Limit Thermostat)

1. The electronic control thermostat has several safety levels built in such that a controlled shutdown should occur before the safety temperature limiter is activated. Should these safety levels be overridden (say external pump overrun failure after shutdown) the safety temperature limiter will trip initiating a boiler shutdown, preventing the boiler from firing. The code **(110)** on the controls display will flash indicating that the safety temperature limiter has tripped.

2. The safety temperature limiter is auto reset located on the top rear of the heat exchanger block. Once the boiler has cooled to normal operating temperature, pushing the reset pushbutton on the display (refer to **section 8.1.1 - Controls Operation**) will reset the lockout. Should the lockout code not extinguish and the boiler does not fire up, it is possible that the safety temperature limiter will not reset because the boiler is still too hot.

3. Always carry out an investigation to ascertain the reason for overheating. The most common cause of overheating is lack of water flow rate through the boiler possibly caused by a faulty pump or blockage in the heat exchanger circuit due to system debris.

9.2 Water Flow Switch

1. The water flow switch is located in the return pipe before the pump and the heat exchanger (**see figure 9.2**) and will prevent the boiler from firing should there be inadequate or no water flow. This is to protect the heat exchanger from damage in the absence of water (dry firing) which will cause catastrophic failure of the heat exchanger.

2. The operation of the flow switch can be checked by closing one of the isolating valves connecting the boiler to the system, this will generate error E164 on the LMU display.

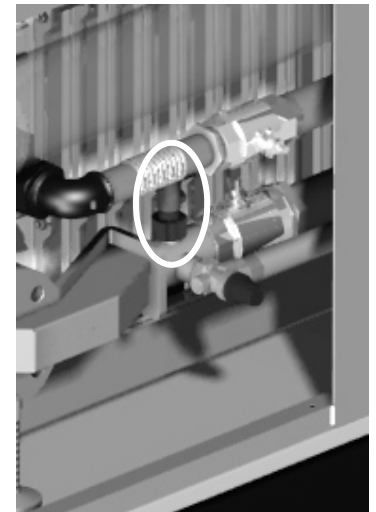
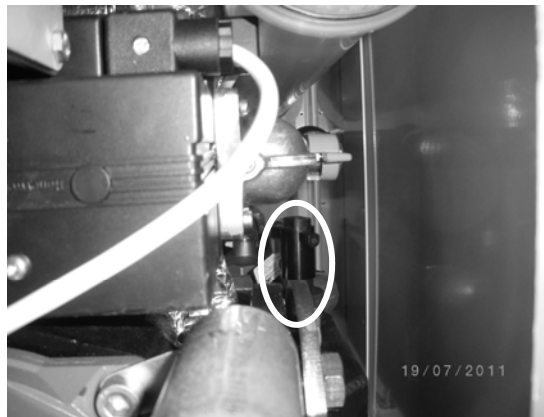

Figure 9.2 - Water Flow Switch

9.3 Ignition Controller

1. The flame is under constant supervision by the burner ignition controller. The controller monitors the flame's ability to rectify an AC current. If the flame diminishes for whatever reason and the rectified current drops below the controller's minimum detection current (3 μ A DC), the controller will de-energise the gas control valve within 1 second and commence a restart. Failure to establish and detect a flame during the light-up sequence will result in burner shutdown and lockout within 5 seconds, requiring a manual reset to restart the ignition sequence. Refer to **section 8.3.9—Maintenance functions**.

2. If the boiler continues to lockout, then an investigation must be made to ascertain the cause. **Refer to figure 8.3.10 - Operating faults**, for possible causes of lockout.

3. A false flame signal at the start and during pre-purge will cause the boiler module to restart its ignition sequence at the end of the pre-purge period. If this occurs 3 times in succession the controls will disable operation of the boiler module, requiring reset of the module. Refer to **section 8.3.10 - Operating faults**

Figure 9.3.1- Wiring Diagram

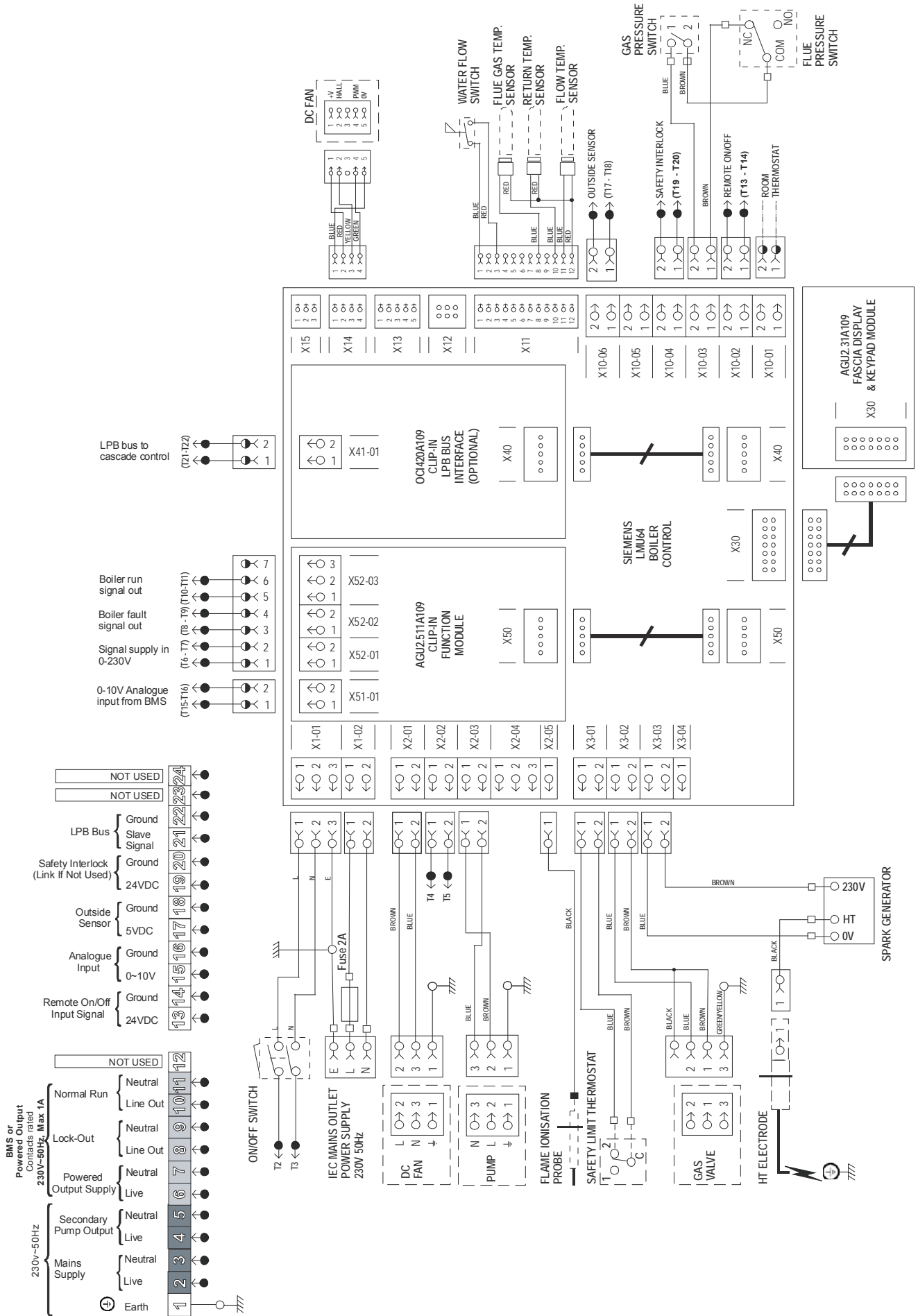

10 SERVICING

A competent person registered for working on non domestic gas appliances should check and ensure that the flue, its support and terminal, the ventilation to the boiler house, safety valve, drain, water filter if fitted, pressure gauge, etc.; are in a serviceable and working condition and still comply with the relevant standards and codes of practice - see **Section 4**.

10.1 Regular servicing is recommended, preferably by a Hamworthy appointed person, and at least annually, to ensure trouble free operation.

For Fleet boilers, Hamworthy would recommend an additional 6 monthly examination following commissioning, acknowledging site conditions and running hours.

Although cleaning of flueways may not be necessary on a yearly basis, it is important that all controls and safety features are checked for correct operation.

Note:- Measuring flue gas CO₂ and gas temperatures will give an indication of the state of the boiler flueways and waterways. Results should be compared with previously measured values to establish possible loss of efficiency.

10.2 Annual Service

Before servicing the boiler, the following procedure must be carried out :-

WARNING: Isolate all electrical supplies and turn off the gas service valve.

1) Open the front casing by turning the 1/4 turn latch with a flat bladed screw driver. Note the latch mechanism passes through slots in the chassis top and bottom.

Once removed access is gained to the controls panel, the heat exchanger components and the combustion system assembly.

2) Disconnect the H.T and flame probe connectors from the respective probes.

3) Disconnect the fan power supply and control leads from the fan taking care with the latch on each connector.

4) Check that the gas service valve is closed, then undo the flange on the inlet to the gas valve.

5) Carefully disengage the air inlet duct from the venturi and remove the electrical plugs from the gas valve.

6) Remove the 3 M6 socket head screws securing the fan /burner duct assembly to the heat exchanger and carefully remove the assembly and the sealing gasket. Carefully remove the burner from the heat exchanger,.

7) Remove and inspect H.T. electrode and flame probe, ensure they are free from debris or deposits. – See Figures 10.2. 10.2.1 & 10.2.2

8) Check the burner and clean using a soft brush if required (if possible use a vacuum cleaner to remove the dust from inside the burner tube). After cleaning the

inside, the burner tube can be washed using a soapy water solution. Tap the burner flange firmly downwards on a block of wood to dislodge any residual debris from inside the burner tube. A damaged or cracked burner should be replaced.

Note:- Do not use a wire brush to clean the burner.

9) Carefully remove the insulation pad from the heat exchanger back plate (accessed through the burner cavity) and replace with a new pad ensuring the edges are 'tucked in' to the gap past the last section

10) Separate the gas valve / gas valve manifold / venturi from the fan inlet noting it's orientation and inspect the fan scroll and impellor, clean and check for damage.

11) Clean and check the venturi for contamination.

12) Remove the fan from the burner duct and inspect the non return valve in the duct for smooth operation.

13) Check that the mesh inlet filter in the gas valve is clear of debris, remove any foreign objects caught in the filter.

Re-assemble in reverse order taking care to inspect and if necessary, replace any o-rings, gaskets or seals.

Refer to **Section 8, Commissioning and Testing**, and test all gas joints broken or disturbed for soundness before firing.

Carry out a combustion check by testing the flue gas CO₂ and CO levels as detailed in **Section 8.2**.

10.3 Four Year Service

Repeat the annual service as previously described but do not refit any components to the heat exchanger.

Isolate the boiler flow and return connections from the heating system.

10.3.1 To clean the heat exchanger, the use of a high pressure water hose (40-80 psi) is recommended for the primary flue gas path. However provision must be made for the drainage of water used in this process. At the rear of the boiler remove the condensate drain trap assembly from the flue elbow. Connect a hose (32mm id.) to the flue elbow and take to a suitable drain or receptacle. The cleaning water and any debris will exit the sump through this opening.

To clean the condensing flue gas path, isolate the boiler from the heating system and drain the boiler heat exchanger using the drain valve provided in the return pipe. Disconnect the electrical supply to the pump, return sensor and the flow switch. Carefully support the pump, disconnect the unions and remove the pump.

Remove the 2 M6 screws securing the return elbow / pipe assembly to the heat exchanger and carefully remove the assembly.

Remove the 4 screws (M8) securing the heat exchanger assembly to the chassis backplate. Disconnect the heat exchanger flow connection from the heating system and the flue pipe from the sump elbow and carefully slide the heat exchanger assembly forward.

With the heat exchanger removed from the appliance, remove the plastic sump from the heat exchanger

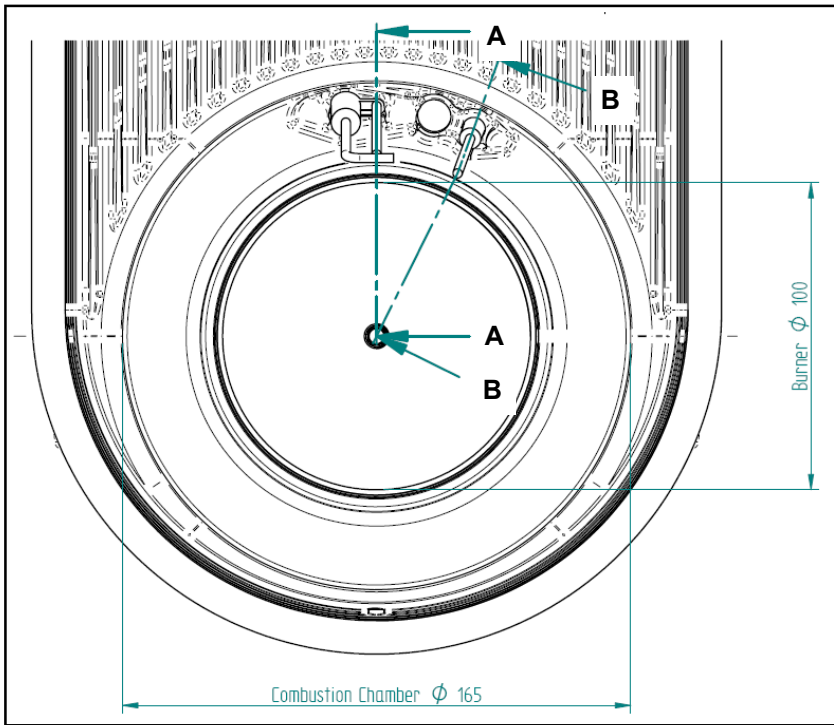

Figure 10.2 - Combustion Chamber

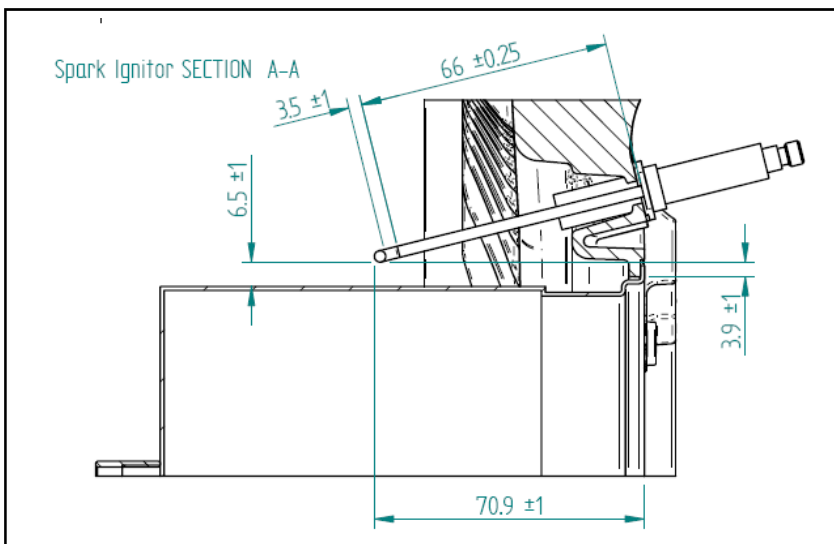

Figure 10.2.1 - Spark Electrode position

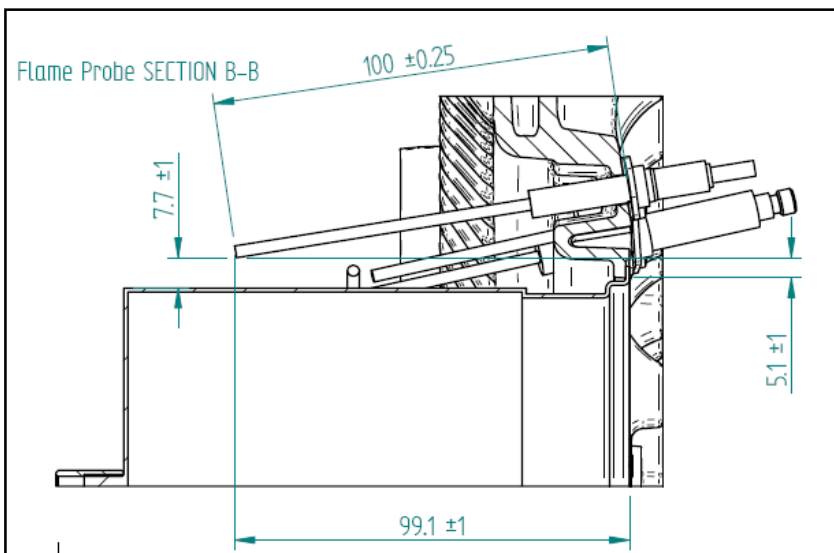

Figure 10.2.2 - Flame Probe position

sealing plate and withdraw the sump away from the sealing plate.

The heat exchanger fin matrix is now accessible and the flue ways can be cleaned using a 25mm wide * 1mm thick* 400mm strip to clean between the fins, ensuring that any debris is collected .

When clean, re-assemble in reverse order using new seals /gaskets where appropriate.

Re-fit the pump and return pipe assembly. Open the isolating valve and test all joints broken or disturbed for water soundness.

Re-fit the burner assembly. **Test all gas joints broken or disturbed for soundness before firing.**

Refer to **Section 8 Commissioning The Boiler.**

11.0 REPLACEMENT OF FAILED COMPONENTS

There are a number of components listed below which can be replaced simply and quickly by following the given procedure. In each case the operation of each replaced component must be checked by carrying out the appropriate part of the commissioning procedure. See **Section 8: COMMISSIONING & TESTING.**

Note:- Isolate all electrical supplies to the boiler module before opening the front cover and commencing any servicing or component exchange procedure. Turn off the gas at the service valve.

11.1 HT Electrode and Flame Probe -

Part nos. 533805029 & 533805021

Note:- The electrode and flame probe ceramics are very fragile.

Disconnect the HT cable from the electrode. Remove the 2 M4 screws securing the electrode to the heat exchanger and carefully remove the electrode and its gasket. Check the condition of the ceramic, wires and the spark gap. Adjust if necessary. In replacing the electrode, fit a new gasket and take care when feeding the wires through the heat exchanger aperture. Carefully re-connect the HT cable to the electrode.

Disconnect the cable from the flame probe. Remove the 1 M4 screw securing the probe to the heat exchanger and withdraw the probe. Check the condition of the ceramic and wire. In replacing the probe fit a new gasket and refit the cable.

To check the position of the electrode and probe in relation to the burner, remove the burner and refer to Figures 10.2. , 10.2.1 & 10.2.2

11.2 Flow / Return sensor - part no. 533901549

Note: The flow/return sensors are immersed in the water circuit. To remove/replace will require the heat exchanger to be drained.

The two identical sensors are located in the return and flow connections. Prior to removal, check the resistance of the sensor against **Figure B 1.3** In refitting the sensor, a sealant will be required on the threads. Check for water soundness before firing the boiler.

11.3 Flue Gas sensor - Part no. 533901549

The flue gas sensor is located in the flue elbow (175-250) or sump sealing plate (300-350) at the rear of the boiler.

Prior to removal, check the resistance of the sensor against **Figure B 1.3** In refitting the sensor, a sealant will be required on the threads. Check for soundness of the joint when firing the boiler.

11.4 Temperature Limiter (Limit Stat)

Part no. 533901583

The limit stat is a bi-metallic disc type located on the top of the last heat exchanger section, secured by a spring clip. The thermostat can be accessed through the rear panel. Remove the thermostat from the clip and disconnect the electrical connections. **Beware the terminals are 230v! When refitting the control ensure that it is fully engaged in the clip.**

11.5 Water Flow switch - Part no. 533901548

Note: The flow is immersed in the water circuit. To remove/replace will require the heat exchanger to be drained.

The water flow switch is located in the return pipe on the pump inlet. Undo the union and carefully withdraw the switch assembly from the pipe. The switch consists of a magnetic reed switch providing open or closed circuit. In fitting a replacement switch ensure that a new sealing gasket is used.

11.6 Gas Valve

Part no. 533903005 - F175 - F300V

Part no. 533903045- F300 - F350V

All models - isolate the gas supply using the valve located in the bottom right hand corner. To access this valve, first remove the air inlet elbow from the venturi by removing the worm drive clip and 4 - M6 fixing screws. Disconnect the electrical lead and pressure sensing tube. Remove the 4 - M5 screws securing the inlet fitting to the gas valve.

Support the weight of the valve and remove the 4 - M5 screws securing the gas valve to the venturi manifold. When replacing the gas valve using new 'o' rings and gasket.

All models - reassemble in reverse order and check all joints for gas soundness.

11.7 Fan

Part no. 533704003 - F175 - F300V

Part no. 533704012 - F350V

To remove the fan it is preferable to remove the complete fan, gas valve and venturi assembly. To access this valve, first remove the air inlet elbow from the venturi by removing the worm drive clip and 4 - M6 fixing screws. Disconnect the electrical lead and pressure sensing tube from the gas valve.

Disconnect the two electrical plugs (power supply and speed control signal) from the fan motor.

Disconnect the gas supply from the inlet to the gas valve. Carefully disengage the air inlet duct from the venturi. Remove the 4 - M5 screws securing the fan assembly to the burner transition duct. Take care not to drop any screws into the duct opening.

Carefully withdraw the complete assembly and place on a suitable working area.

Remove the screws securing the gas valve and venturi assembly to the fan inlet, noting the position of the venturi.

All models - reassemble in reverse order using new gaskets and check all joints for gas soundness.

11.8 Main control pcb - LMU - refer to spares list

The LMU is located by two screws on the electrical control panel which is secured to the boiler chassis . Carefully disconnect all plug connections from the LMU, taking note of their location. The plugs are polarised to prevent incorrect fitting.

If a 'clip in module' is fitted, this must be removed and transferred to the new LMU. Carefully disconnect the plug connecting the clip in to terminal X40 or X50. Depress the latch at the plug end of the clip in and disengage the module from the LMU.

Fit the replacement control in reverse order. Remember to apply the parameters local to the installation - refer to section 8.

11.9 Display screen - Part no. 533901437

Carefully disconnect the ribbon cable connecting the screen to the LMU terminal X30. Remove the 4 screws

securing the screen to the fascia moulding, taking care not to loose the button covers, which are loose when the assembly is separated.

Refit the button covers to the new display and secure to the fascia moulding.

11.10 Low gas pressure switch - Part no. 533901497

Isolate the gas supply using the valve located in the bottom right hand corner.

Disconnect the electrical plug after removing the securing screw. Remove the screw securing the switch to the gas valve body.

When re-fitting a replacement switch remember to set the operating pressure to 12mbar.

11.11 Air Pressure Switch - Part no. 532496004

Disconnect the sensing tube from the switch noting the position. Disconnect the electrical connections noting their position. Remove the 2 screws securing the switch to the control panel. The replacement switch is factory set.

12.0 RECOMMENDED SPARES

Please Note:- To ensure the correct spare parts are despatched by our spares department, it is imperative that the complete Boiler/Module/Control Panel Serial Numbers are given. The Boiler and Module Serial Numbers are located on the Data Plates affixed to the combustion chamber front panel. The Electrical Panel Serial Number is located inside the Control panel on the rating label. These numbers **MUST** be quoted when ordering spare parts.

SPARES ITEM	PART No.
ELECTRICAL ITEMS	
LMU control - F175V Nat Gas	533901634
LMU control - F200V Nat Gas	533901635
LMU control - F250V Nat Gas	533901636
LMU control - F300V Nat Gas	533901637
LMU control - F350V NatGas	533901638
Display PCB	533901437
HT Ignition Transformer	533901542
Flow / Return Sensor	533901549
Flue Gas Sensor	533901549
Water Flow Switch	533901548
Temperature Limiter	533901583
HT Ignitor Electrode.....	533805029
Ht Ignitor Lead	533901547
Flame Sensing Probe.....	533805021
On/Off switch	533925009
Fascia fuse T2A	533922009
Pump relay	533901639
Pump fuse T10A	533901640
Clip in Module - vfc + 0~10v - AGU2.511A109	533901438
Clip in Module - LPB Bus communication - OCI420A109.....	533901456

MECHANICAL ITEMS

Burner Fabrication - F175V	533301035
Burner Fabrication - F200V	533301036
Burner Fabrication - F250V	533301037
Burner Fabrication - F300V	533301038
Burner Fabrication - F350V	533301039
Gas Control Valve - F175V - F300V	533903005
Gas Control Valve - F350HV	533903045
Gas Control Valve 'O' ring - F175V - F350V	531299032
Combustion Fan - F175V - F300V	533704003
Combustion Fan - F350V	533704012
Venturi - F175V	532418009
Venturi - F200V	532418010
Venturi - F250V - F350V	532418001
Low Gas Pressure Switch	533925004
Air Pressure Switch	532496004
Flue System Non Return Valve	563007022
Safety Pressure Relief Valve	531905013
Gasket - gas valve to venturi manifold	531201174
Gasket - Burner to heat exchanger	531201162
Gasket - Fan to burner duct	531201071
Gasket - Burner duct	531299041
Gasket - Ignitor	531201160
Gasket - Probe	531201161
Pump F175V - F200V	530905061
Pump F250V - F300V	530905062
Pump F350V	530905063
Gasket - Pump F175V - F200V	531201164
Gasket - Pump F250V - F350V	531201118
View Port Sight Glass	339907043
Air Inlet Filter	532812008
Heat exchanger insulation pad	533806119

CASING ITEMS

Front door panel	560650267
LH side panel - F175V - F250V	530650473
RH side panel - F175V - F250V	530650474
LH side panel - F300V - F350V	530650475
RH side panel - F300V - F350V	530650476
Top Panel - F175V - F250V	530650479
Top Panel - F300V - F350V	530650480

For service or spares please contact :-

Hamworthy Heating Ltd
Fleets Corner
Poole
Dorset BH17 0HH

Phone Number01202 662500
Fax Number01202 665111
Service01202 662555
Spares01202 662525
Technical01202 662500

APPENDIX A - GAS DATA

GENERAL DATA	BOILER MODEL			
	F175V-350	F175V-525	F200V-400	F200V-600
Boiler Input (maximum) - kW (Gross)	359.7	539.5	411.1	616.6
Boiler Input (maximum) - kW (Nett)	324.1	486.1	370.4	555.6
Boiler Output (maximum) condensing 50/30°C - kW	350	525	400	600
Boiler Output (maximum) non condensing 80/60°C - kW	316.6	474.9	361.8	542.7
Boiler Module Output (minimum) 80/60°C - kW	31.7	31.7	36.2	36.2
Boiler Module Output (minimum) 50/30°C - kW	35.0	35.0	40.0	40.0
	F250V-500	F250V-750	F300V-600	F300V-900
Boiler Input (maximum) - kW (Gross)	513.8	770.7	616.6	924.9
Boiler Input (maximum) - kW (Nett)	462.8	694.2	555.6	833.4
Boiler Output (maximum) condensing 50/30°C - kW	500	750	600	900
Boiler Output (maximum) non condensing 80/60°C - kW	452.4	678.6	542.7	814.2
Boiler Module Output (minimum) 80/60°C - kW	45.2	45.2	54.3	54.3
Boiler Module Output (minimum) 50/30°C - kW	50.0	50.0	60.0	60.0
	F350V-700	F350V-1050		
Boiler Input (maximum) - kW (Gross)	719.3	1079.0		
Boiler Input (maximum) - kW (Nett)	648.2	972.3		
Boiler Output (maximum) condensing 50/30°C - kW	700	1050		
Boiler Output (maximum) non condensing 80/60°C - kW	633.2	949.8		
Boiler Module Output (minimum) 80/60°C - kW	63.3	63.3		
Boiler Module Output (minimum) 50/30°C - kW	70.0	70.0		

GAS DATA - per boiler module	F175V	F200V	F250V
Gas Inlet Connection Pipe Thread Size	R 1"	R 1"	R 1"
Nominal Inlet Pressure Nat Gas -mbar	20		
Maximum Inlet Pressure Nat Gas -mbar	25		
Gas Pressure Switch Setting Nat Gas -mbar	12.5		
Gas Flow Rate (max. per module) Nat Gas -m ³ /h	17.1	21.7	24.4
Target CO ₂ % at High / Low fire Nat Gas ±0.25%	9.2 / 10.0		
	F300V	F350V	
Gas Inlet Connection Pipe Thread Size	R 1¼"	R 1¼"	
Nominal Inlet Pressure Nat Gas -mbar	20		
Maximum Inlet Pressure Nat Gas -mbar	25		
Gas Pressure Switch Setting Nat Gas -mbar	12.5		
Gas Flow Rate (max. per module) Nat Gas -m ³ /h	29.3	34.2	
Target CO ₂ % at High / Low fire Nat Gas ±0.25%	9.2 / 10.0		

Figure A1- Gas data

APPENDIX B - ELECTRICAL CONNECTIONS AND CONTROLS

ELECTRICAL DATA - per boiler module	BOILER MODEL		
	F175V	F200V	F250V
Nominal supply voltage	230V ~ 50Hz		
Power Consumption (maximum) - W	560	560	550
Start and Run Current (per module) - A	3.5/2.2	3.5/2.2	3.5/2.2
	F300V	F350V	
Nominal supply voltage	230V ~ 50Hz		
Power Consumption (maximum) - W	580	1500	
Start and Run Current (per module) - A	3.7/2.5	8.5/6.0	

Figure B1 - Electrical supply

B1 ELECTRICAL SUPPLY

IMPORTANT: Individual boilers must be earthed.

The boiler must be isolated from the mains electricity supply in the event of electric arc welding being carried out on any connecting pipe work.

1. Wiring external to the boiler must be installed in accordance with the IEE Regulations and any local regulations which apply. Wiring must be completed in heat resistant 3-core cable of 1.0mm² cross sectional area. Boilers are normally supplied for connection to a 230 volts, 50Hz mains supply. The boiler control is supplied with a replaceable fuse (T6.5A). The pump has a separate fuse (T10A) External fuses should be 15A for all boilers.

2. 3-Phase Electrical Supplies. Individual modules of Fleet boilers and any boilers installed in close proximity to each other **MUST NOT** be supplied from different phases of a 3 phase supply. The method of connection to the mains electricity supply must facilitate complete electrical isolation of the single boiler / battery with a separation of at least 3mm in all poles.

3. A mains isolator must be provided adjacent to the boiler in a readily accessible position. The supply should only serve the boiler.

4. Multiple modules. It is highly recommended that each boiler is connected via its own mains isolator to facilitate servicing and maintenance of the individual boiler whilst leaving the remaining boilers in operation.

5. Further details regarding connection to the electricity supply are given in BS EN 60335, Part 1 or BS 3456, Part 201.

WARNING: THE MAINS POWER SUPPLY MUST NOT BE SWITCHED BY A TIME-CLOCK CONTROL.

CAUTION: DO NOT FEED MAINS VOLTAGE ONTO THE TIMER TERMINALS

6. The mains power supply must be maintained at all times. Each Fleet boiler module incorporates a remote enable link, which can be used to operate the boiler(s) under a timed regime. The boiler controls provide a 24V DC signal that can be fed through a volt free contact for operation. Refer to BS 6644 for further information on installing the electrical supply.

7. The integral pump in Fleet boilers is managed by the LMU boiler control.

NOTE: FOR BASIC TERMINATION DIAGRAM SEE FIGURE 4.6

Figure B1.2 - External Control Wiring for Multiple Module Installation

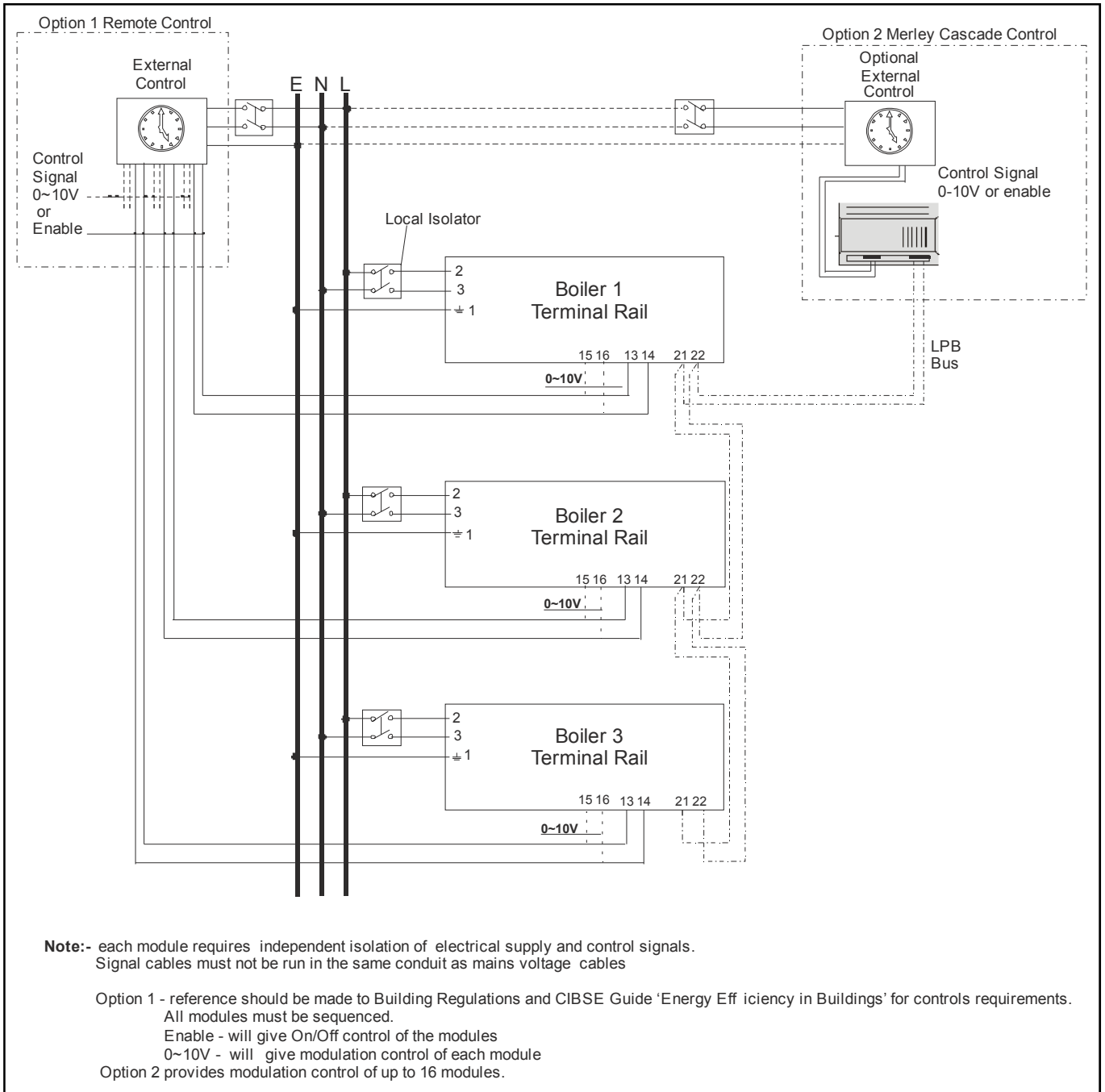

BMS Connections

For 0 - 10v connection, the input signal must be connected to terminals 15 & 16 - see figure 4.6

Note: any safety interlocks MUST be wired across the 0- 10v circuit using suitable low voltage contact ratings.

For connection of an external alarm device, use terminals 8 & 9, which are volt free and rated at 230v - see figure 4.6

For an optional programmable room thermostat, use connector X10-01 on the LMU - see figure B.1.3

Figure B1.3 - Sensor resistance values

T [°C]	R[Ohm]	T [°C]	R[Ohm]	T [°C]	R[Ohm]
-30.0	175203	50.0	3605	130.0	298
-25.0	129289	55.0	2989	135.0	262
-20.0	96360	60.0	2490	140.0	232
-15.0	72502	65.0	2084	145.0	206
-10.0	55047	70.0	1753	150.0	183
-5.0	42158	75.0	1481	155.0	163
0.0	32555	80.0	1256	160.0	145
5.0	25339	85.0	1070	165.0	130
10.0	19873	90.0	915	170.0	117
15.0	15699	95.0	786	175.0	105
20.0	12488	100.0	677	180.0	95
25.0	10000	105.0	586	185.0	85
30.0	8059	110.0	508	190.0	77
35.0	6535	115.0	443	195.0	70
40.0	5330	120.0	387	200.0	64
45.0	4372	125.0	339		

APPENDIX C - FLUE DATA - Natural Gas

FLUE DATA per boiler module			BOILER MODEL		
			F175V	F200V	F250V
Flue connections (concentric)	-	mm	130/200, 150/220		
Flue /Air connections (twin duct)	-	mm	130/100		
Flue connection (B23 open flue)	-	mm	130		
Approx. Flue Gas Temperature @ 80/60°C	-	°C (Gross)	60		
Approx. Flue Gas Temperature @ 50/30°C	-	°C (Gross)	40		
Pressure at the boiler flue outlet	-	Pa/mbar	150	150	150
Approx. Flue Gas Volume @ 9.2% CO ₂	-	m ³ /h*	225	260	325
			F300V	F350V	
Flue connections (concentric C33)	-	mm	150/220		
Flue /Air connections (twin duct C53)	-	mm	150/100		
Flue connection (B23 open flue)	-	mm	130		
Approx. Flue Gas Temperature @ 80/60°C	-	°C (Gross)	60		
Approx. Flue Gas Temperature @ 50/30°C	-	°C (Gross)	40		
Pressure at the boiler flue outlet	-	Pa/mbar	150	150	
Approx. Flue Gas Volume @ 9.2% CO ₂	-	m ³ /h*	390	450	

* **Note:-** Flue gas volumes are corrected to a flue gas temperature of 15°C and barometric pressure of 1013.25mbar.

C1.0 FLUE SYSTEM

1. Detailed recommendations for flue systems are given in BS 6644, and IGE/UP/10. All flue discharges for plant exceeding 150kW output must comply with the third edition of the 1956 Clean Air Act Memorandum.

WARNING: THE FLUE DISCHARGE FROM A FLEET BOILER WILL GENERATE A PLUME AT THE TERMINAL EXIT. THIS MUST BE CONSIDERED WITH REGARD TO TERMINAL LOCATION AND ADJACENT BUILDING FABRIC.

FOR B23 INSTALLATIONS THE HAMWORTHY AIR INLET FILTER (532812008) **MUST** BE USED

C1.1 General Requirements

The Fleet boilers are designed to be used with natural draught or room sealed flues. Flue systems should be designed in accordance with regulations and with reference to BS 6644 and IGE/UP/10.

The following points should be noted:

a. Due to the high thermal efficiency of the boiler, condensation will occur in the flue. It is strongly recommended that the design of the flue system recognises this. HHL supply plastic flue components and suitable terminals to discharge the flue gases safely. The Fleet flue systems supplied by Hamworthy are non UV stabilised polypropylene and are therefore suitable for internal use only. For external flue runs and termination, either use the dedicated kits supplied by Hamworthy or refer to a chimney specialist .

b. Care should be taken to ensure that the flue is installed such that any condensation is continuously drained. Any flue system with a horizontal section should have a maximum slope of 3° upwards in the direction of the exhaust gas flow. All joints should be such that any condensation is directed back down the slope to an open drain connection in the flue. The drain pipe must be manufactured from a corrosion resistant material and at least 15mm diameter. It must have a fall of at least 3° (approx. 50mm/meter) and connect to a drain via a waste trap.

c. Boiler flue outlet sizes - A flue system designed with the same diameter as the boiler flue outlet may not provide satisfactory performance in all applications. Consideration must be given to the correct calculation of the required flue size. If in any doubt consult Hamworthy Heating Ltd who can supply a full flue design and installation service.

C1.2 Waste Gas Volume and Temperature.

It is recommended that the volume and temperature of the waste gases used for design of the flue system are as given in the above tables.

C1.3 Materials.

Materials used for the flue system must be mechanically robust, resistant to internal and external corrosion, non-combustible and durable under the conditions to which they are likely to be subjected. Consideration must be given to avoid possible freezing of condense water traps and pipe work.

C1.4 Suction

The flue system must be designed acknowledging that there is a positive pressure generated by the boiler combustion fan. Refer to table Appendix C.

The flue system must be designed to limit the max. suction (cold) to 30Pa negative, measured at the connection to the boiler. If the suction is greater than 30Pa, refer to HHL technical. This condition must then be checked hot and with all boilers firing, the max. pressure at the connection to the boiler should be 150Pa positive.

In the event that the flue system when hot does generate a suction, the max. suction is 100Pa.

Any stabiliser fitted must be in or close to the vertical chimney.

C1.5 Disconnection

Provisions should be made for disconnection of the flue pipe for servicing. It is advisable that bends are fitted with removable covers for inspection and cleaning as appropriate.

WARNING: THE FLUE SYSTEM MUST BE SELF SUPPORTING AND NOT PRESENT A RISK TO PEOPLE IN OR AROUND THE BUILDING.

C1.6 Flue Discharge

The flue system must ensure safe and efficient operation of the boiler protecting the combustion process from wind effects and dispersing the products of combustion to the external air. The flue must terminate in a freely exposed position and be so situated as to prevent the products of combustion entering any opening in a building. Where the flue diameter is less than 204mm (8") diameter a terminal must be fitted. Where the flue is of a larger size, consideration should be given to the fitting of a flue discharge terminal or grille to stop ingress of birds etc.

C1.7 Surface Temperatures

Combustible materials in the vicinity of the boiler and flue shall not exceed 65°C during boiler operation. The flue shall not be closer than 50mm to any combustible material, except where it passes through such material with a non-combustible sleeve when the air gap may not be less than 25mm.

C1.8 Location

The flue system must not be placed or fitted where there is undue risk of accidental damage to the flue pipe or undue danger to persons in the vicinity. Check that the flue and chimney are clear from any obstruction. Fleet boilers are suitable for installation in a balanced compartment in accordance with the requirements of BS 6644. Consult Hamworthy Heating Technical Department for help or assistance if in doubt. For B23 applications the HHL air inlet filter MUST be used to ensure the correct air inlet requirements.

Flue Load kW	Flue Ø mm	Equivalent lengths (m)		
		Max L	45°	90°
350	200	75	4	5
400	200	50	4	5
500	200	25	4	5
600	200	10	4	5
500	250	100	5	6.5
700	250	50	5	6.5
900	250	25	5	6.5
900	300	75	6.0	8.0
1050	300	50	6.0	8.0

Table C6.1 - Flue equivalent lengths

C1.9. Condensate Discharge

Due to the high thermal efficiency of the boiler, condensation will occur within the boiler casing during firing from cold conditions. A drain with an integral trap is fitted to each module suitable for connection to a 40mm o.d. plastic waste pipe (not Hamworthy Heating Ltd supply), which must be connected to a tundish (not Hamworthy Heating Ltd supply). Discharge piping from a tundish should be of synthetic material due to the mild acidity of the condensate (pH3-5), with all discharge piping having a minimum fall of 50mm/m away from the boiler. Consideration should be given to possible freezing of condense water traps and pipe work. This must be avoided at all times by routing pipe work within the building, where possible.

In addition to the above, should the plastic flue system supplied discharge into a metallic chimney system, any condensate formed in the chimney MUST NOT drain back through the plastic components to the boiler. A separate drain for the chimney system must be provided.

FOR B23 INSTALLATIONS THE HAMWORTHY AIR INLET FILTER (532812008) **MUST BE USED.** (In instances where a B53 (ducted air inlet) is connected to a cascade (B23 outlet), the air inlet filters need not be fitted and therefore can be discarded).

APPENDIX D - VENTILATION

D1.1 Air Supply

Detailed recommendations for air supply are given in BS 6644 and BS5440 Pt 2. The following notes are intended to give general guidance. In all cases there must be provision for an adequate supply of air for both combustion and general ventilation, in addition to that required for any other appliance.

Note: For Open flue applications, combustion air for the boiler is drawn through the top of the boiler casing. The air inlets **must** be kept open and free from blockage at all times.

D1.2.1 Air Supply by Natural Ventilation - Open Flue applications

The boiler room must have, or be provided with, permanent air vents directly to the outside air, at high level and at low level. For an exposed boiler house, air vents should be fitted, preferably on all four sides, but at the least on two sides. Air vents should have negligible resistance and must not be sited in any position where they are likely to be easily blocked or flooded or in any position adjacent to an extraction system which is carrying flammable vapour. Grilles or louvres must be so designed that high velocity air streams do not occur within the space housing the boiler.

Boiler house ventilation

Low level (inlet) - 4cm² per kW of total rated input (Net)
High level (output) - 2cm² per kW of total rated input (Net)

Compartment ventilation

Where the boiler is to be installed in a cupboard or compartment, permanent high and low level ventilation is required which must communicate direct to outside, for cooling purposes.

Low level (inlet) - 10cm² per kW of total rated input (Net)
High level (output) - 5cm² per kW of total rated input (Net)

D1.2.2 Air Supply by Natural Ventilation - Room Sealed Installations

Where the boiler(s) are to be installed in a boiler room or internal space, the room or internal space must have permanent air vents directly to the outside air, at high level and at low level with the general requirements detailed above on location and construction.

Boiler house ventilation

Low level (inlet) - 2cm² per kW of total rated input (Net)
High level (output) - 2cm² per kW of total rated input (Net)

Compartment ventilation

Where the boiler is to be installed in a cupboard or compartment, permanent high and low level ventilation is required which may communicate to an adjoining room or outside, for cooling purposes.

Ventilation to a room or internal space - 10cm² per kW of total rated input (Net)
Ventilation direct to outside - 5cm² per kW of total rated input (Net)

D1.3 Air Supply by Mechanical Ventilation

Air supplied to the boiler room by Mechanical means should be as follows:

- 1) Mechanical ventilation must be interlocked with the boilers to prevent operation in the event of ventilation fan failure
- 2) Mechanical inlet and mechanical extract can be utilised providing the design extraction rate does not exceed one third of the design inlet rate.
- 3) Mechanical extract ventilation with natural inlet ventilation **MUST NOT** be used.

For Mechanical ventilation systems an automatic control should be provided to cut off the gas supply to the boiler, in the event of failure of air flow in either inlet or extract fans.

D 1.4. Boiler House Temperatures

The air supplied for boiler house ventilation shall be such that the maximum temperatures within the boiler house shall be as follows:

At floor level (or 100mm above floor level) = 25°C.

At mid-level (1.5m above floor level) = 32°C.

At ceiling level (or 100mm below ceiling level) = 40°C.

D 1.5. General Requirements

The air supply should be free from contamination such as building dust and insulation fibres from lagging. To avoid unnecessary cleaning and servicing of the boiler modules, the boilers should not be fired whilst building work is being undertaken.

High and low level ventilation grilles shall be positioned as high and as low as practicably possible. Low level grilles should be located within 1 metre of the floor for Natural Gas. High level grilles should be positioned within 15% of the boiler room height from the ceiling. High and low level grilles shall communicate with the same room or space where compartment ventilation is used. Where grilles communicate directly with outside air, they shall be positioned on the same wall.

Figure D1 Mechanical Ventilation Flow Rates

	Flow rate per kW total rated heat input (Net)	
	Inlet air (Combustion ventilation)	Difference between Inlet & Extract air *
	m ³ /h.	m ³ /h.
Volume	2.6	1.35

Note * : Where the associated air extraction is also by means of a fan, this shall be selected such as not to cause a negative pressure to develop in the boiler house and to maintain the difference between inlet and extract flow rates shown above.

The calculated extract flow rate is the actual inlet flow rate minus the appropriate figure in the table above.

APPENDIX E - WATER DATA

WATER DATA			BOILER MODEL		
			F175V	F200V	F250V
Water connections (Flow & Return)	-	BSP	R 1½"		
Maximum Water Pressure	-	bar g	6.0		
Minimum Water Pressure	-	bar g	0.5		
Water content (not including headers)	-	litres	13.0	15.0	17.0
Design Flow Rate @ 20°C ΔT Rise	-	litre/s	2.1	2.4	3.0
Waterside Pressure Loss @ 20°C ΔT Rise	-	mbar	270	310	155
Residual pump performance available	-	mbar	300	160	325
			F300V	F350V	
Water connections (Flow & Return)	-	BSP	R 2"		
Maximum Water Pressure	-	bar g	6.0		
Minimum Water Pressure	-	bar g	0.5		
Water content (not including headers)	-	litres	20.0	25.0	
Design Flow Rate @ 20°C ΔT Rise	-	litre/s	3.6	4.2	
Waterside Pressure Loss @ 20°C ΔT Rise	-	mbar	210	260	
Residual pump performance available	-	mbar	170	660	

Figure E1 - Water Data

E1.1 Water Circulation System

The Fleet boiler has a low water content and the requirements of minimum water flow are given in the above table. To ensure these minimum requirements are achieved each boiler is fitted with an integral pump for circulation through the boiler and primary circuit supplemented by an integral flow switch. Recommendations for the water circulation system are given in BS 6644 and CP 342.

The following details are of particular importance for the correct installation of the water circulation system:

- 1) In a combined central heating and hot water system the hot water storage vessel must be of the indirect cylinder or calorifier type. The hot water storage vessel should be insulated, preferably with not less than 75mm (3") thick mineral fibre, or its thermal equivalent.
- 2) Circulating pipe work not forming part of the useful heating surface should be insulated to help prevent heat loss and possible freezing, particularly where pipes are run through roof spaces and ventilated cavities. Cisterns situated in areas which may be exposed to freezing conditions should also be insulated. Furthermore, insulation exposed to the weather should be rendered waterproof.
- 3) Drain valves must be located in accessible positions which permit the draining of the whole system, including the boiler and hot water storage vessel.
- 4) Each boiler module has flow and return connections as detailed in the table above. Multiple boilers should be connected by flow and return headers. Hamworthy strongly recommend that boilers are connected in a primary circuit configuration utilising a low loss header arrangement to enable secondary circuits to be connected to the header. Figure E1.1.1 on the following page show typical layouts.
- 5) Ideally, individual valves should be fitted to each module to enable isolation from the system, however, the arrangement must comply with the requirements of BS 6644.

E1.2 Pressure Relief Valve (Safety Valve)

The most important single safety device fitted to a boiler is its safety valve. Each boiler module is provided with an integral safety valve terminating at the return pipe at the rear of the boiler. BS 6644 provides comprehensive information for the selection and location of safety valves and attention is drawn to the higher capacity requirements of safety valves for pressurised hot water systems.

E1.3 Altitude Gauge (Water Pressure Gauge)

Every boiler or group of boilers should be provided with an altitude gauge complete with isolating valve. See Figure E1.1.1 for typical position.

E1.4 Open Vent and Cold Feed Pipe.

Every boiler or group of boilers should have an open vent pipe and cold feed pipe installed between the boiler and the first water isolating valve. The minimum bore (mm) of these pipes per installation is shown in the table. The vent pipe must rise continually, any valve fitted between a boiler and the open vent pipe for maintenance purposes shall be of the 3 way type such that when closed to the vent pipe the boiler will be open to atmosphere. The vent pipe shall be protected against freezing where this might occur. See BS 6644 for detailed information on Open Vent and Cold Feed Pipes.

E1.5 Thermometer

A thermometer complete with pocket should be fitted in the pipe work to indicate water flow temperature. See Figure E1.1.1 for typical position.

E1.6 Drain Valves

Each boiler has a 15mm NB drain valve fitted in the boiler return, for draining the boiler only. The heating system in total should have drain valves as recommended by BS 6644. See Figure E1.1.1 for typical position.

E1.7 Circulating Pump

Each individual boiler is fitted with an integral circulating pump ensuring flow through the boiler and primary circuit. To ensure the correct flow through the boiler, there is a balancing valve fitted to the flow pipe within the boiler. This is factory set and must not be adjusted.

One or more circulating pumps will be required to circulate water around the heating system. All pumps should be sited to facilitate servicing. It is important that when Fleet boilers are used to replace boilers on an existing system, the system design must be modified acknowledging the performance of the integral circulating pump. It is also important that the existing system be flushed through twice to remove any loose matter which may have accumulated. To protect the boiler heat exchanger, it is strongly recommended that a dirt/air separator is fitted in the return to the boiler. If in any doubt regarding the cleanliness of the system, a coarse filter should be fitted in the return pipe work to the boilers.

E1.8 Minimum Water Flow Rates

Minimum water flow rates are shown in table at beginning of Appendix E. These flow rates should be maintained through the boiler at all times whilst the boiler is firing. To prevent the boiler firing in the event of poor or no flow, the boiler is fitted with an integral flow switch. Particular attention should be paid to the restriction of external flow circuits during periods of low heat demand.

Each boiler module is fitted with a flow balancing valve on the return pipe within the unit. This valve may require adjustment to ensure the correct flow through the boiler - refer to commissioning instructions Section 7.7

E1.9 Waterside Pressure Drop

The waterside hydraulic resistance (Pressure drop) is given in table at beginning of Appendix E.

E1.10 Water Flow Controls

The Fleet boiler is fitted with an integral circulating pump, which will shut off circulation 5 minutes after the boiler has ceased firing.

Any external mixing valve / shunt pump or similar controls MUST always ensure that the minimum water flow rate as given in table at beginning of Appendix E is maintained. As a precaution, the Fleet boiler is fitted with a flow switch. The flow switch is designed to operate such that the boiler will shut down if insufficient flow occurs.

E1.11 Frost Protection

Consideration should be given to fitting an optional outside air sensor, to provide the necessary frost protection.

E1.12 Unvented Systems

Refer to Figure E1.1.1 on opposite page for typical layout of an unvented (Pressurised) Hot Water System. For system design refer to BS 7074 Part 2. In order to correctly size a pressurisation unit for any heating system the following parameters are required.

- 1) Static height of highest component in system (metres)
- 2) System volume. If this is not known, a general rule of thumb of 10litres/kW of installed boiler power can be used.
- 3) Maximum flow temperature (°C)
- 4) Maximum system hot working pressure, generally given in bar gauge.

From the parameters given, Hamworthy Heating can size the pressurisation unit and also the expansion vessel.

Figure E1.1 - Typical Piping Layouts

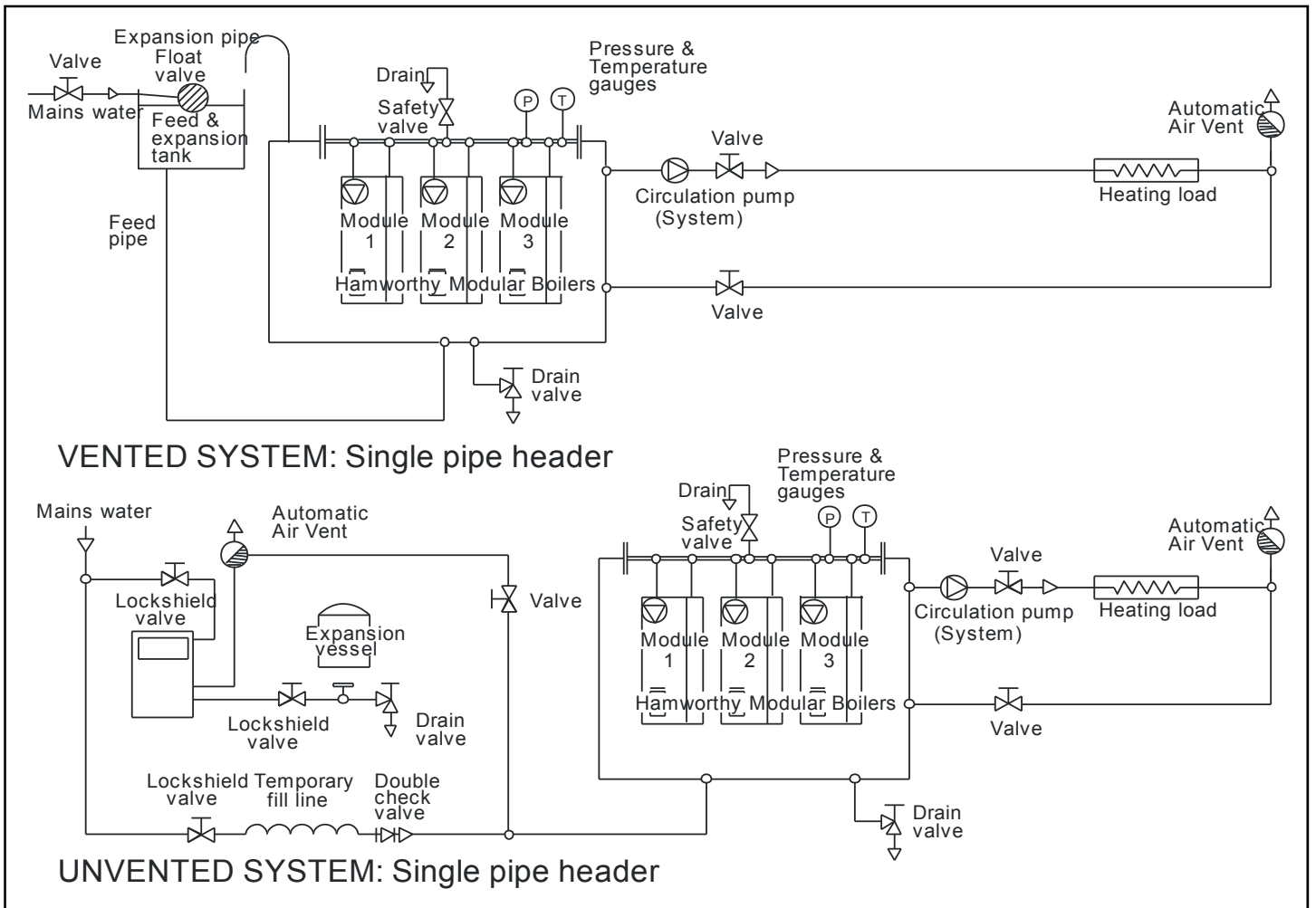

Care must be taken in sizing expansion vessels to ensure maximum acceptance factors are not exceeded. Normally manufacturers of vessels impose a limit of 0.5. This value must not be exceeded at any time during the operation of the boiler, this includes the over pressure condition should a safety valve lift.

Consideration should also be given to sizing of the safety valve(s) in the system. Refer to BS 6759: Part 1 for further information and to BS 6880: Part 1 for design considerations.

E 1.13 Minimum System Water Pressure

To comply with guidance note **PM5 (Health and Safety Executive)**, the minimum pressure requirements at the boiler are given below as examples:-

- 1) Single installed boiler running at 82°C flow temperature. Minimum head required is not less than 2.0 metres or 0.2 bar.
- 2) Single installed boiler running at 90°C flow temperature. Minimum head required = 3.0 metres or 0.30 bar.
- 3) Modular boiler installation running at 82°C flow temperature and 11°C rise across system. Minimum head required = 4.4 metres or 0.43 bar.
- 4) Modular boiler installation running at 82°C flow temperature and 15°C rise across system. Minimum head required = 6.5 metres or 0.64 bar.

Figure E1.4 Cold Feed and Vent Pipe Sizes

Boiler Output	Feed mm	Vent mm
150 - 300 kW	32	38
300 - 600 kW	38	50
>601 kW	50	65

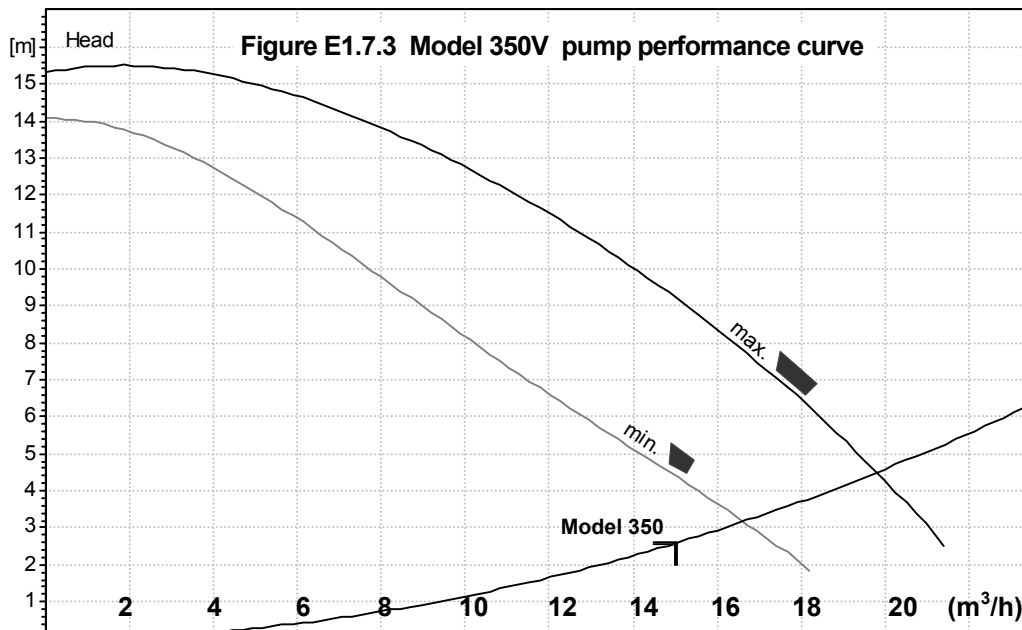
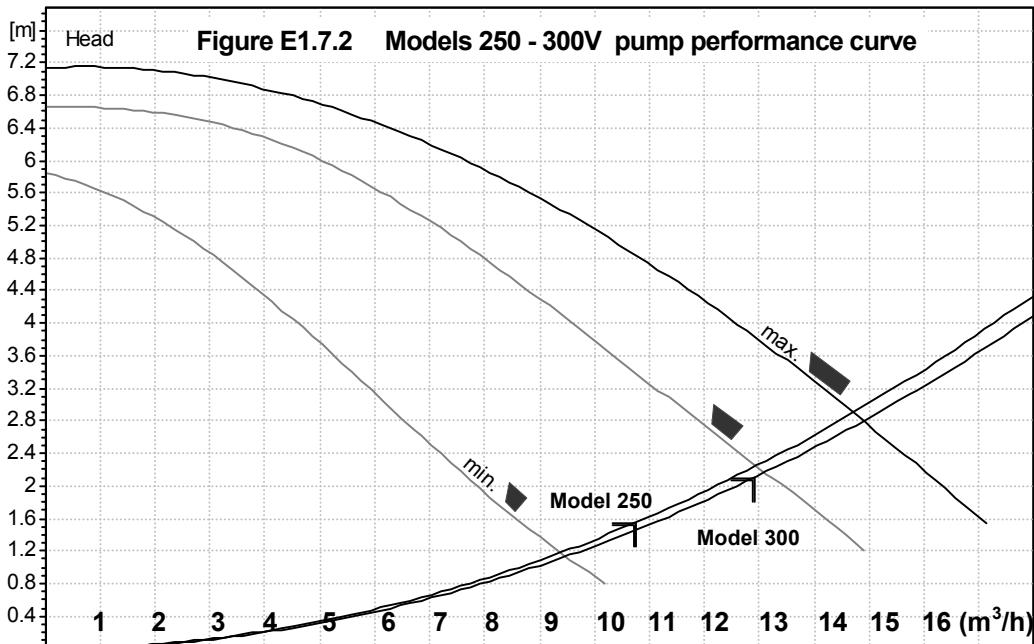
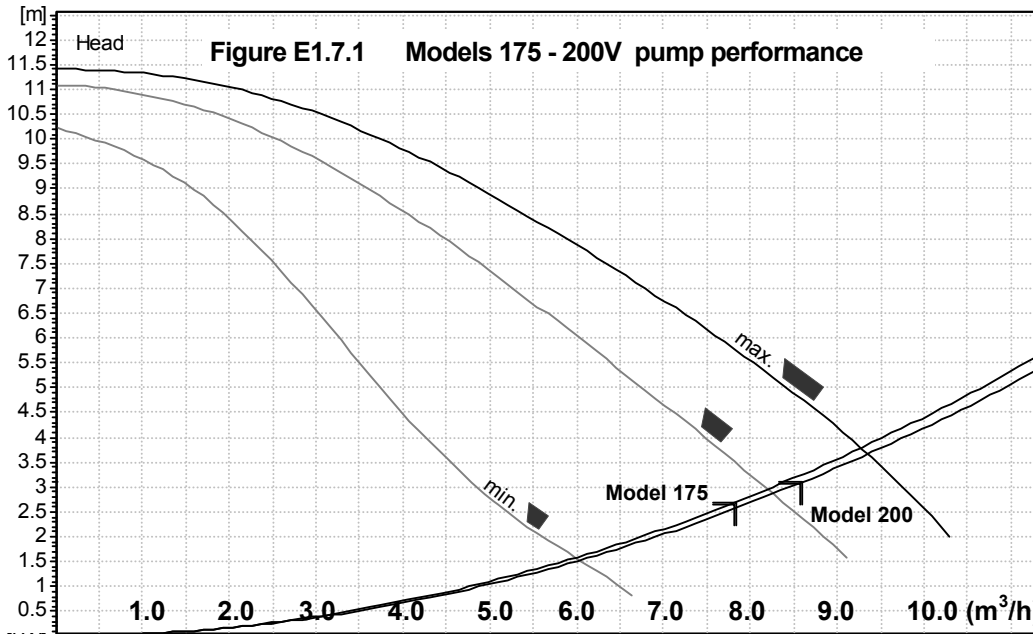

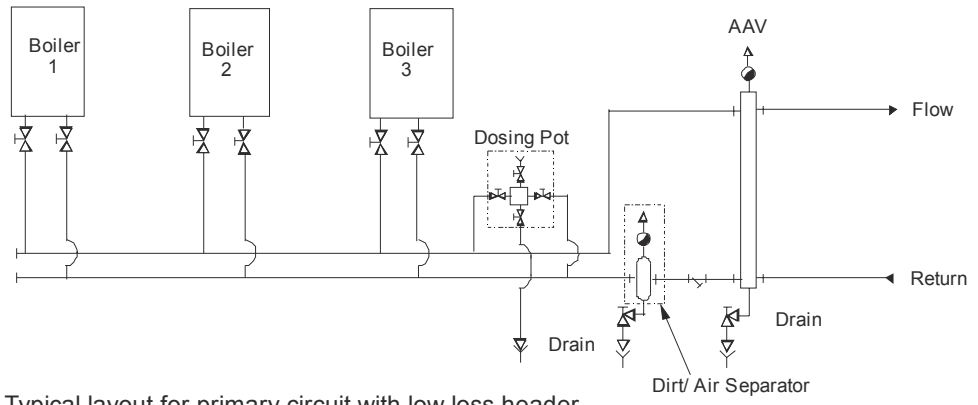
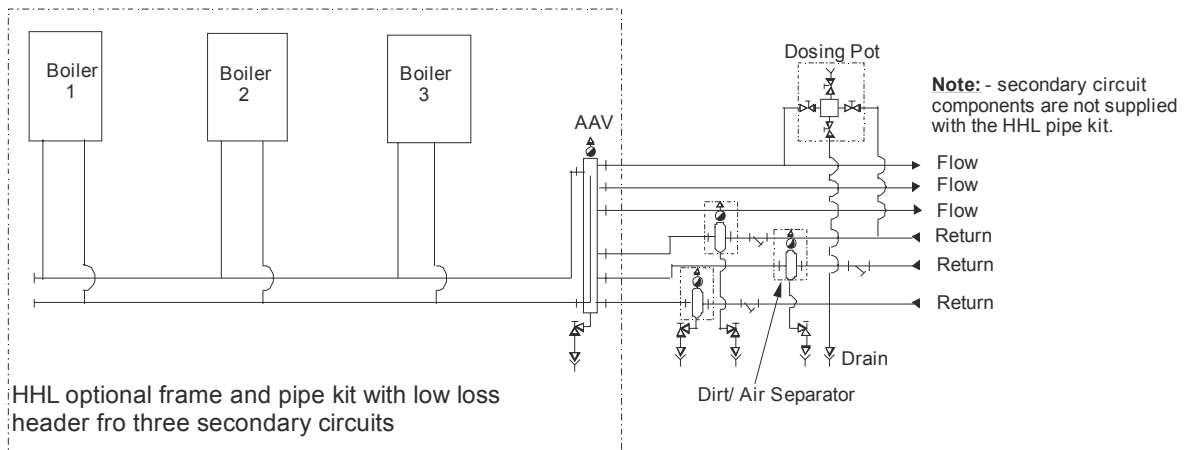
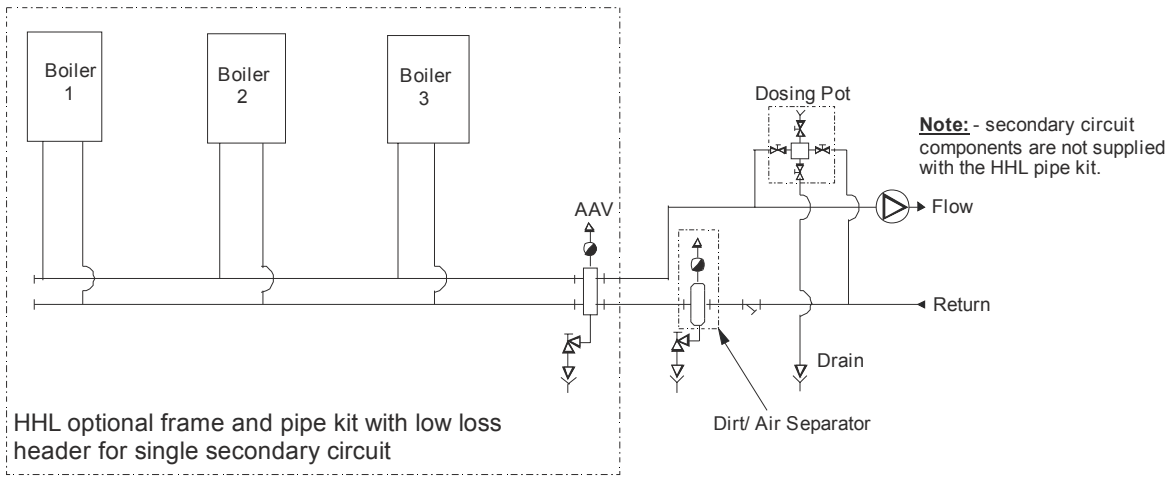

Typical layout for primary circuit with low loss header

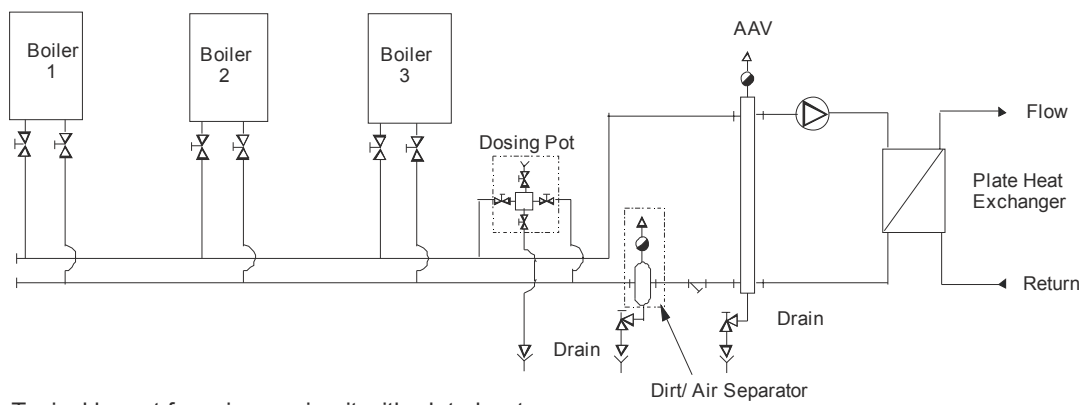

Typical layout for primary circuit with plate heat exchanger separation of secondary circuits

Figure E2 - Typical Pipe Kit system connections

APPENDIX F - CASCADE CONTROL

To Convert the boiler hydraulic diagram for cascade control :

Before programming changes are made, ensure the boiler is set to standby mode.

Press and hold both up and down arrow keys for at least five seconds to enter advanced parameter list H90 displayed top right of HMI screen.

Use either up or down arrow key to scroll through the parameter list and stop at H552

Option 1 - for use with the Merley sequence controller

To enable cascade control change the setting by using the + or – key and set value to 80.

Press mode button to store change and return to home screen.

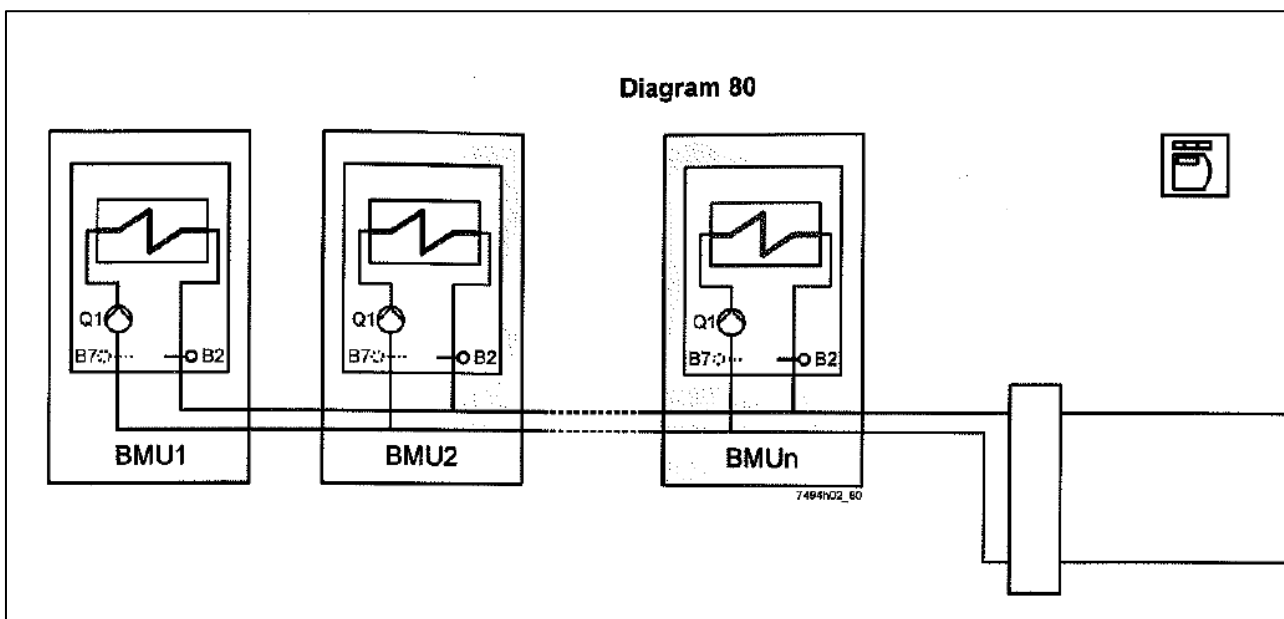

Figure. F2

NOTES:

USEFUL USER INFORMATION

INSTALLER

SITE ADDRESS

--

--

BOILER TYPE

BOILER SIZE(S)

UNIT NO(S).

SERIAL NO(S).

FLUE

--

--

--

--

--

Business Reply Plus
Licence Number
RSRR-JHEB-YAKC



Hamworthy Heating Ltd
Fleets Corner
Poole
BH17 0HH

Notes

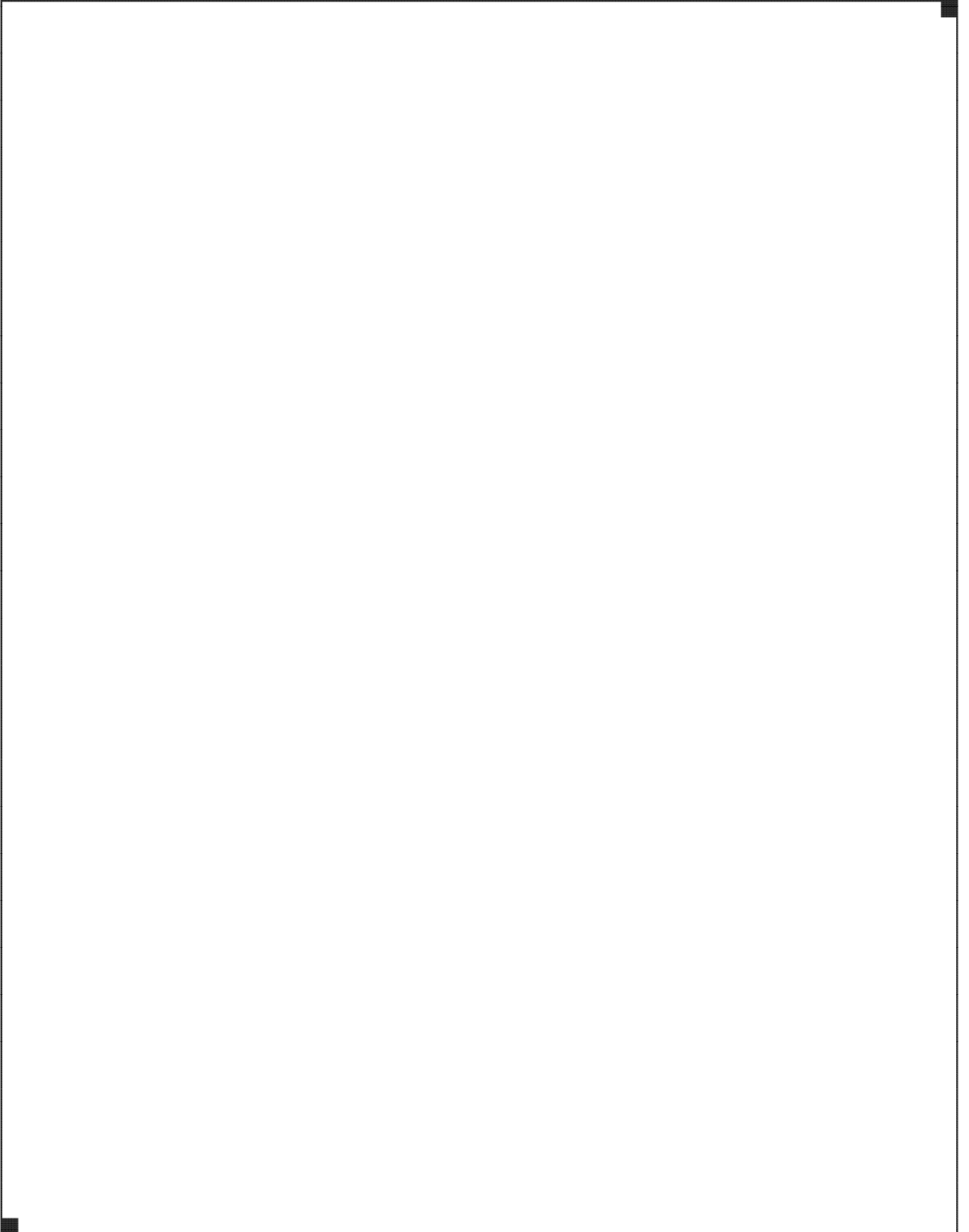

Hamworthy Heating Accredited Agents

North West England (Sales & Service)

Gillies Modular Services
210-218 New Chester Road, Birkenhead, Merseyside L41 9BG
tel: **0151 666 1030** fax: **0151 647 8101**

Southern Ireland (Sales & Service)

HEVAC Limited
Naas Road, Dublin 12, Ireland
tel: **00 353 141 91919** fax: **00 353 145 84806**

Northern Ireland (Sales & Service)

HVAC Supplies Limited
Unit A6, Dargan Court, Dargan Crescent, Belfast BT3 9JP
tel: **02890 747737** fax: **02890 741233**

Scotland (Sales & Service)

McDowall Modular Services
2 Penston Road, Glasgow, Scotland G33 4AG
tel: **0141 336 8795** fax: **0141 771 9635**

North East England (Service)

Allison Heating Products
12 Sunnyside Lane, Cleadon Village, Sunderland SR6 7XB
tel: **0191 536 8833** fax: **0191 536 9933**

Hamworthy Heating Customer Service Centre

Sales

tel: **0845 450 2865**

Technical Enquiries

tel: **0845 450 2865**

Servicing

tel: **01202 662555**

Spares

tel: **0845 450 2866**



Customer Service Centre

Hamworthy Heating Limited,
Fleets Corner, Poole,
Dorset BH17 0HH

Telephone: **0845 450 2866**

Fax: **01202 662522**

Email: **aftersales@hamworthy-heating.com**

Website: **www.hamworthy-heating.com**