

DEMU FIXING ANCHORS

TECHNICAL PRODUCT INFORMATION



DEMU FIXING ANCHORS

DEMU-FIX 14-E

CONCRETE

NEW!

ETA approvals for:
T-FIXX® anchors ETA-13/0222
Bolt anchors ETA-13/0401



INTEGRATION DEMU METAALINDUSTRIE / HALFEN

Integration of DEMU Metaalindustrie into HALFEN



DEMU production plant in Utrecht

As of 1st January 2012 HALFEN fully integrated the DEMU Metaalindustrie B.V. production, sales and logistics into its organisation. Local HALFEN sales organisations in each country are now also responsible for the sales and distribution of DEMU products.

HALFEN supplies DEMU products directly to the concrete and construction industry. Other customers are supplied through local representatives.

Quality guaranteed
DEMU quality management is certified according to ISO 9001 by Kiwa.



Technical support

Please contact us if you require technical support. The contact information for your country can be found on the inside back cover.

Further information can also be found online. Please visit www.halfen.com, www.demu.com or www.t-fixx.com.

Incorporating DEMU Metaalindustrie B.V. sales within HALFEN requires DEMU ordering numbers to be replaced by HALFEN ordering numbers. Please bear this in mind when ordering.



Please contact us for further catalogues and assembly instructions. Calculation software and current price lists are also available.

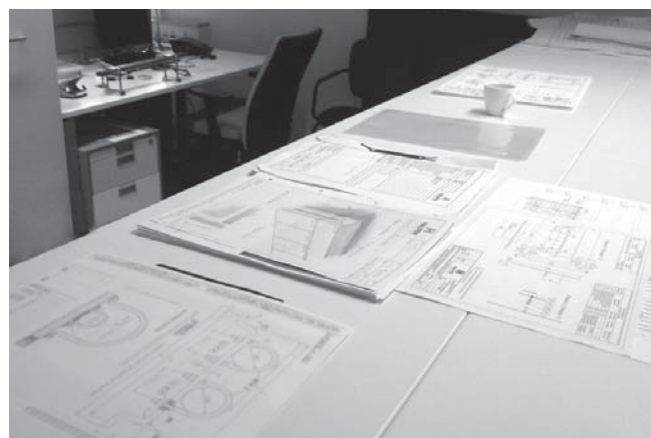

DEMU FIXING ANCHORS

Contents



Systematic fixing solutions	4
- Application examples	4
- Advantages	5
- Typical situations / Load diagrams	6
- Design concept	7-8
General technical information	8
- Material / Corrosion protection	8-9
- Changes in the product range	10-11
T-FIXX® anchors	12
- General information	12
- T-FIXX®	13
Bolt anchors	14
- 1988	14-16
- 1985	17
- 1980-P	18-19
Bar anchors	20
- 4010 / 3016 / 3010 / 1980-S / 1988-S	21-26
- 4030 / 1554 / 1558	27-30
- Bending of bar anchors	31
Socket anchors	32
- VEMO Socket anchors	32-33
Accessories	34
- Fixing pins, nailing plates, sealing caps, thread adapters	34-35
Installation instructions	36
- Fixing anchors, accessories	36-37
Fixing components – assembly instruction	38
- General information / Determining bolt length	38
Software	39
- Calculation basics / About the DEMU software	39-41
- Tender text	41
- Calculation example	42
Contact	43

SYSTEMATIC FIXING SOLUTIONS

Application Examples

FIXING OF BALCONY RAILINGS



FIXING AND ADJUSTING PRECAST ELEMENTS



CAST-IN FIXING ANCHORS



INSTALLATION OF FIXING ANCHORS



FIXING OF PROPS ON PRECAST ELEMENTS



APPLICATION IN PRECAST ELEMENTS FOR STADIUMS



FIXING OF SEATS



FIXING OF BRIDGE RAILINGS



Systematic Fixing Solutions













The advantages at a glance

D EMU Fixing anchors with internal thread are intended to be used for permanent anchorages under predominantly static actions or

quasi-static actions in reinforced and unreinforced normal weight concrete from strength class C20/25 to C50/60.

They may be used in cracked or non-cracked concrete for transmission of tensile loads, shear loads or a combination of both.



	T-FIXX®	Bolt anchor	Bar anchor	Socket anchor
Loads	Medium load capacity	High load capacity	High load capacity	Low load capacity
Application	<ul style="list-style-type: none"> high/medium loads near edges applications (up to high strength concrete) thin elements load capacity of concrete decisive normal strength concrete 	<ul style="list-style-type: none"> high loads use in full concrete (without influence of edges) high steel strength required up to high strength concrete 	<ul style="list-style-type: none"> high tension loads (pullout) use in frontside of thin elements (deep embedment required) high steel strength required up to high strength concrete 	<ul style="list-style-type: none"> low loads temporary fixings fixings without structural significance
Examples for typical use	<ul style="list-style-type: none"> fixing of railings for balconies, bridges fixing of utility equipment or power lines, installation brackets fixing of stadium seats fixing of steel stairs or ladders fixing of connection between precast elements 	<ul style="list-style-type: none"> fixing of railings for balconies, bridges fixing of utility equipment, power lines, installation brackets fixing of stadium seats fixing of steel stairs or ladders 	<ul style="list-style-type: none"> fixing of railings for balconies, bridges fixing of utility equipment, power lines, installation brackets fixing of stadium seats fixing of steel stairs or ladders 	<ul style="list-style-type: none"> fixing of push pull props on precast elements fixing of windows fixing of machines on foundation (without dynamic loading) temporary bracing of precast elements
Design concept / Calculation	 according to CEN/TS 1992-4-1/2	 according to CEN/TS 1992-4-1/2	 according to EN 1992-1-1 (chapter 8.4) / NEN 6720 art. 9.6 and 9.16	
Calculation Software				
ETA approval				

SYSTEMATIC FIXING SOLUTIONS

Typical Situations / Load Diagrams

Load behaviour

In order to clarify the load behaviour and advantages of the different fixing anchor types in different situations, the following gives a short overview of the main applications.

The load behaviour – i.e. the load capacity as a function of different concrete classes – of certain types of T-FIXX® is compared with the cor-

responding types of DEMU Bolt anchors 1988, as illustrated in the diagrams.

A detailed calculation of the load behaviour (with all its project specific influences such as the concrete strength, edge distances, etc.) can be done with the help of the software available from HALFEN / DEMU (→ see chapter "Software", pages 39–42).



Fixing anchor embedded in full concrete (without edge influence)

Situation 1: The load capacity of concrete is decisive, higher steel strength of bolt anchors compared to T-FIXX® does not increase the load bearing capacity N_{Rd} of the anchoring system. Only the concrete strength and the effective anchoring length govern the load capacity of the system.

Example: Short embedment length of fixing anchor (thin element)

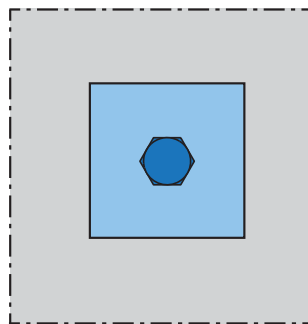

Top view: Screw and fixture in anchor embedded in full concrete

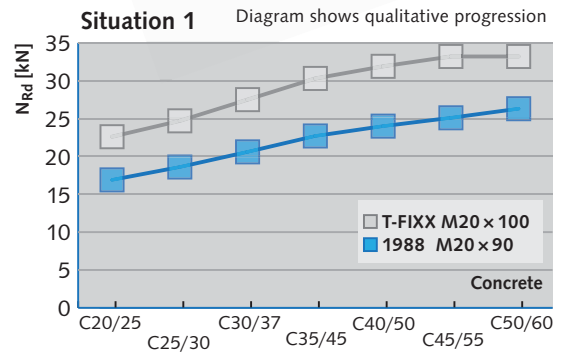

Situation 2: The load capacity of the steel is decisive, steel strength governs the load bearing capacity of the anchoring system. Steel load capacity of T-FIXX® is fully achieved, thus – in contrast to bolt anchor – increasing concrete strength does not allow higher values for N_{Rd} .

Example: Long embedment length of fixing anchor, high strength concrete

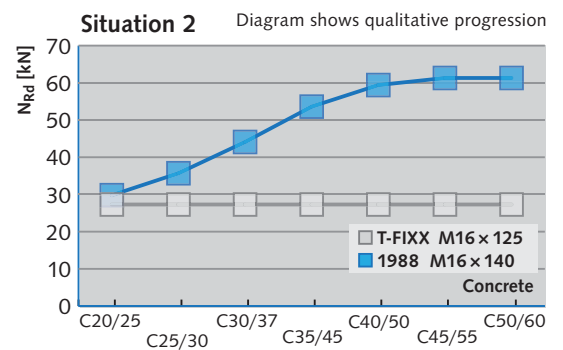

Near edge anchor fixing

Situation: The load capacity of concrete is decisive, higher steel strength of bolt anchors compared to T-FIXX® does not increase the load bearing capacity N_{Rd} of the anchoring system. Only the concrete strength and the effective anchoring length govern the load capacity of the system.

Example: Fixing anchor near edges

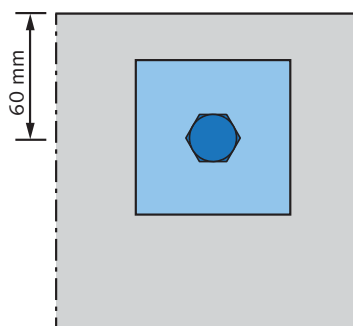

Top view: Screw and fixture in anchor embedded near the edge of the concrete element

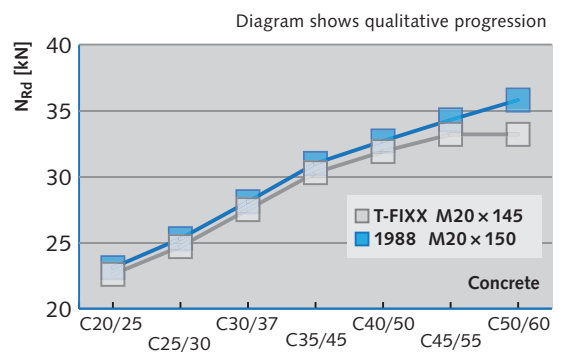

SYSTEMATIC FIXING SOLUTIONS

Design Concept

Design concept

Planning standards apply for the whole of the European Union

- The European standard CEN/TS 1992-4 was issued in 2009 and covers the design method for "Design of fastenings for use in concrete".
- This approval standard represents current state of the art technology standards and may be used in all applications.
- To apply the European calculation method, product specific values such as load bearing capacities are necessary. These and further special regulations for dimensioning are included in the DEMU calculation software.
- This calculation method is supported by a comprehensive user-oriented and easy-to-use design software.

What is the CEN/TS 1992-4?

A European CEN standard was created with the aim of standardising the dimensioning of fastenings in concrete to a common basis. Cast-in fixings such as headed fasteners as well as post-installed anchors are regulated in this standard.

The standards committee CEN/TC 250/SC 2/WG 2 "Design of fastenings for use in concrete" was founded in 2000 with members from nine European nations.

In 2009, the set of regulations was published as CEN/TS 1992-4, TS "Technical Specification". This is a preliminary standard with the aim of conversion to a European standard. With its publication this standard represents state of the art technology and may be used in practice.

This preliminary CEN/TS 1992-4 standard has five parts:

- "General"
- "Headed bolts"
- "Anchor channels"
- "Dowel – Mechanical"
- "Dowel – Chemical"

With the switchover to one standard, this technical specification will become part of the European Concrete Standard EN1992. With the publication of the ETA for T-FIXX® and DEMU Bolt anchors in 2013, the publication of all resources and documents as well as personal consultations, the future is already being prepared.

CEN/TS 1992-4 can be used if a technical specification is available for the fixings, which confirms the suitability of the product and contains the characteristic values necessary for dimensioning a fixing. For building products, a ETA (European Technical Approval) represents this document.

The European Technical Approval is a confirmation of the usability of a building product as defined by the Construction Products Directive (CPD) / Regulation (CPR).

The ETA is based on tests, assessments and a technical evaluation by expert bodies appointed by the members of the EOTA. It comprises all product characteristics which are significant for compliance with statutory requirements in the member states, whereby the relevant requisite performance level may differ nationally or may depend on the intended purpose.

The resistances to steel failure are listed in the European Technical Approval. The load bearing capacities are provided with dimensioning equations. Here all influences on the load bearing capacity of the fixing anchor are taken into consideration. The DEMU Fixing anchors may be used in all concrete strength classes from C20/25 to C50/60. The planned strength is incorporated in the verifications.

The flexible dimensioning concept allows for the development in reinforced concrete construction towards using even lower component thicknesses with higher concrete strengths. For example, the resistance to concrete failure is 55% higher in a concrete of strength class C50/60 than in concrete of strength class C20/25. It is therefore possible to compensate lower edge distances with a higher concrete strength.



SYSTEMATIC FIXING SOLUTIONS

Design Concept

Verification method according to CEN/TS 1992-4

Required verifications according to CEN/TS 1992-4

Tensile stress		Transverse stress	
Type of failure	Verification	Type of failure	Verification
Steel failure of fastener	$N_{Ed} \leq N_{Rd,s}$	steel failure of fastener without lever arm	$V_{Ed} \leq V_{Rd,s}$
Pull-out failure	$N_{Ed} \leq N_{Rd,p}$	steel failure of fastener with lever arm	$V_{Ed} \leq V_{Rd,s}$
Concrete cone failure	$N_{Ed} \leq N_{Rd,c}$	concrete edge failure	$V_{Ed} \leq V_{Rd,c}$
Splitting failure	$N_{Ed} \leq N_{Rd,sp}$	concrete pry-out failure	$V_{Ed} \leq V_{Rd,cp}$
Blow-out failure ^①	$N_{Ed} \leq N_{Rd,cb}$		

① Not required for fasteners with $c > 0,5 h_{ef}$

Notes regarding the table

- N_{Ed} and V_{Ed} are tension or shear stress respectively, acting on the fixing anchor.
- CEN/TS 1992-4 also regulates additional reinforcement; further verification must be provided here.
- Fixing component (bolt with standard metric thread) has to be verified separately in accordance with the customers' planners data and specifications.

GENERAL TECHNICAL INFORMATION

Material

Material codings

Following abbreviations and icons help to illustrate the various materials and coatings used in this catalogue:

- WB** Untreated/mill finished
- GV** Zinc galvanised
- FV** Hot-dipped galvanised
- A4-50** Stainless steel, strength class 50
- A4-80** Stainless steel, strength class 80

Welding

All steel products in this catalogue are weldable. However, any welding, including tack welding, to DEMU-products can negatively influence their mechanical properties. Welding can affect the performance of the product.

If welding in the application is unavoidable, take the following into account:

- a possible change in performance; a possible reduction in load capacity
- remove any coating layer before welding, and ensure welding fumes are safely extracted during welding
- use mandatory protective equipment
- the customer is responsible for making sure that applicable welding regulations are respected



HALFEN and DEMU are not liable for any damage caused to or by DEMU products that have been subsequently welded.

GENERAL TECHNICAL INFORMATION

Material and Corrosion Protection

Corrosion protection

Galvanising:

Zinc galvanising (GV)

Zinc galvanising (chromium VI free) with a passivation treatment is used.

The coating thickness is approximately 5–8 µm.

After galvanising the products are dipped in a bichromate solution for passivation. The corrosion resistance is limited and depends on the immediate environment.

All threaded zinc galvanized products (T-FIXX® anchors, bolt anchors, bar anchors) have a yellow tint. Therefore the anchors are easily to distinguish from stainless steel types.

This does not apply to VEMO socket anchors.

Hot-dip galvanising (FV)

Hot-dip galvanising can only be used for the following connectors and threaded anchor types: 1988, 1980-P, 1980-S, 1988-S, 4010, 4030, 1554 and 1558. The connectors are first galvanised by dipping in a galvanising bath of approx. 460°C and then cutting the internal thread.

The thread is unprotected. The coating layer of the subsequently installed hot-dipped galvanised bolt provides corrosion protection to the thread on the connector. It is not possible to hot-dip galvanise VEMO socket anchors shown on pages 32 – 33 as the sleeves are crimped at one end. According to EN-ISO 1461 the coating thickness is at least 50 µm.

Stainless steel (A4)

Chromium is the most important alloying element in stainless steel. A specific chromium concentration ensures the generation of a passive layer on the surface of the steel that protects the base material against corrosion. This explains the high corrosion resistance of stainless steel.

Material and its application

Corrosion protection	Application
Zinc galvanising (GV)	Class 1: Insignificant corrosion exposure / Dry interior rooms Fixing anchors may only be used in structures subject to dry internal conditions (e. g. accommodations, bureaus, schools, hospitals, shops).
Hot-dip galvanising (FV)	Class 2: Low corrosion exposure Fixing anchors may also be used in structures in unheated / uninsulated buildings where condensation may occur (e. g. warehouses, sport halls, parking garages), as well as in structures not exposed to rain in outside atmosphere with low level of pollution (mostly rural areas).
Stainless steel (A4)	Class 3: Medium corrosion exposure Fixing anchors may also be used in structures subject to external atmospheric exposure (including industrial and marine environment) or exposure in permanently damp internal conditions, if no particular aggressive conditions (e. g. permanent, alternating immersion in seawater) exist.

T-FIXX® made entirely of stainless steel

The T-FIXX A4 is made entirely of stainless steel; there is no requirement for minimal concrete cover as components cannot corrode.

Areas of application:

- bridge and tunnel construction (e. g. fastening of pipes)
- chemical industry (e. g. installations exposed to aggressive substances)
- reinforced concrete elements with increased demands on the concrete cover



No application for high corrosion level, when high concentrations of chlorides, sulphur and nitrogen oxides are present: For example road tunnels, structures in salt water and indoor swimming pools.

GENERAL TECHNICAL INFORMATION

Changes in the Product Range

Changes since 1st January 2012

The new DEMU anchor, the T-FIXX[®], became available on 1st January 2012.

It is not a socket anchor and it is not a bolt anchor – it is a clever combination of both, and can be used as a replacement for either product type.

T-FIXX[®] can replace many other socket anchors

- In terms of load capacity T-FIXX[®] can replace all types of socket anchors of the same dimensions and because of its higher performance it is possible that a T-FIXX[®] of a smaller (thread) M-size can replace larger socket anchors! This will also allow a smaller bolt diameter so the cost for the fixing can be reduced. Our sales team can also advise you on further cost effective planning.
- In addition T-FIXX[®] can also replace bolt anchors in applications where the concrete strength is decisive, such as in small components, small centre-to-centre distances or small edge distances.

DEMU and HALFEN quality and reliability

The quality of our products is very important. The new T-FIXX[®] was tested extensively before production started. Using a dedicated calculation program engineers can design a safe and quality solution using T-FIXX[®]. The software can be downloaded from the HALFEN-, DEMU- or T-FIXX[®]-website.

In addition to the demand for cost-effective products, we recognise that safety and quality issues are becoming increasingly important in the market. HALFEN and DEMU lead the way in responding to these trends with a continued focus on product-innovation and quality.

Replacement of some socket anchors

Until now DEMU has provided over 160 different types of socket anchors in its range. Since 1936, when the socket anchors were first introduced to the market by DEMU, the range was extended to specific customer requests. This resulted in different types of socket anchors with similar performance. Customers have indicated that greater uniformity (fewer types) would be beneficial. With the introduction of T-FIXX[®] as substitute anchors for our whole range, the time has arrived to revise our anchor range.

End of production

We have already ceased production of types 995 and 995-A, 1036 and 1036-A, 1074-A and the 1168-A.

Alternatives for discontinued socket anchors

The HALFEN Sales Department can help you to find suitable alternative anchors for your applications. The overview on the following page illustrates replacements for discontinued DEMU Socket anchors.

Reliable delivery times

Effective delivery times are very important for HALFEN and DEMU. Supplying 160 different types from stock in a complex market is no longer time and cost-effective. By improving our socket anchors range and our delivery times we can help increase your productivity. T-FIXX GV and T-FIXX A4 orders can nearly always be taken from stock. We do this by using CNC production methods for T-FIXX[®]. CNC which can run 7 days a week, 24 hours a day. This allows us greater flexibility in production and more efficient delivery times.

Software

HALFEN / DEMU provide an up-to-date calculation software, which includes values for T-FIXX[®].

The software can be downloaded free from the following websites:

- www.halfen.de
- www.demu.com
- www.t-fixx.com

For technical support please contact us. (→ see inside back cover for contact information)

GENERAL TECHNICAL INFORMATION

Changes in the Product Range

Range from 1st January 2012

Zinc galvanised (GV)



Stainless steel (A4)



T-FIXX® A2 products are available on request (non-stock item).

Alternatives to discontinued socket anchors

Discontinued socket anchors

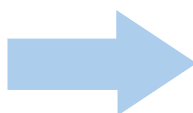
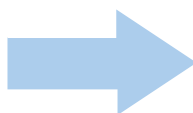
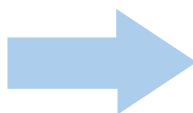
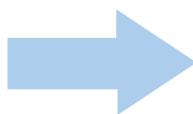
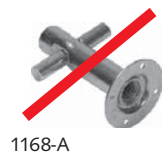
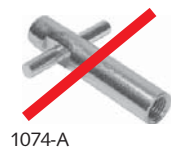
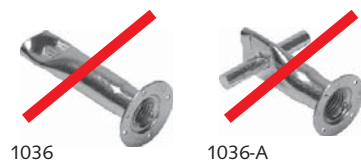

Alternatives (same thread diameter and length)^①

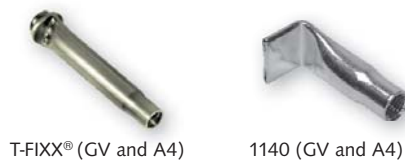

① Because of its high performance it is possible that T-FIXX® in smaller sizes can support similar loads to larger socket anchors! This will also allow a smaller bolt diameter and reduce costs for the fixing.

T-FIXX® ANCHORS

General / T-FIXX GV

General Information

The DEMU Fixing anchor T-FIXX® with European Technical Approval is an innovative combination of socket anchor and bolt anchor.

T-FIXX® is calculable for each situation.

22 standard versions/sizes are available in zinc galvanised (GV) or stainless steel (A4). The zinc galvanised version of the T-FIXX® is yellow galvanised (chromium VI free) and therefore visually distinguishable from the stainless steel types.



T-FIXX GV



T-FIXX GV

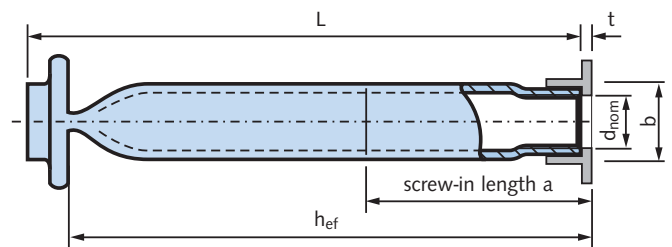

Anchor description

The T-FIXX GV is manufactured from a steel precision tube (strength class E235).

The surface is zinc galvanised (GV), the internal thread is metric ISO.

For identification a grey plastic data clip is attached ($t=2\text{ mm}$).



Please download our calculation software to calculate the load capacity of this anchor according to CEN/TS 1992-4-1/2.

www.halfen.de → service → software.

For information about our software see page 39.

T-FIXX GV incl. data clip (grey)

Order no.	Dimensions				Design loads for tension ^①		
	d _{nom} x L [mm]	h _{ef} [mm]	a [mm]	b [mm]	N _{Rd,c} [kN]	N _{Rd,c} [kN]	N _{Rd,s} [kN]
					C20/25	C45/55	Steel
0020.270-00001	M10 x 50	43.7	32	13.5	8.2	10.1	10.1
0020.270-00002	M10 x 75	68.7	32	13.5	10.1	10.1	10.1
0020.270-00003	M12 x 50	42.5	30	17	7.9	11.6	16.8
0020.270-00004	M12 x 70	62.5	38	17	14.0	16.8	16.8
0020.270-00005	M12 x 95	87.5	38	17	16.8	16.8	16.8
0020.270-00006	M16 x 60	51.3	32	21.3	10.4	15.4	27.3
0020.270-00007	M16 x 100	91.3	50	21.3	24.7	27.3	27.3
0020.270-00008	M16 x 125	116.8	50	21.3	27.3	27.3	27.3
0020.270-00009	M20 x 70	61.2	44	26.9	13.6	20.1	35.3
0020.270-00010	M20 x 100	91.2	62	26.9	24.7	35.3	35.3
0020.270-00011	M20 x 145	136.2	62	26.9	35.3	35.3	35.3

① The design load is the calculation value according to CEN/TS 1992-4-1/2 for normal tensile force in plain concrete without load-reducing influences. Values only apply for cracked concrete; no dense reinforcement (risk of shell spalling). Design loads are valid for (structural) fixings and are not permitted for lifting!

T-FIXX® ANCHORS

T-FIXX A4

Minimum allowed element thickness, minimum edge distances and spacing

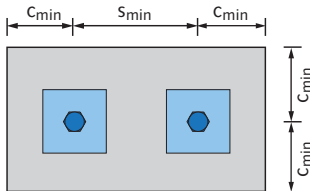

Top view: Concrete member with 2 fixing anchors embedded.

Thread size	d	[mm]	M 10	M 12	M 16	M 20
Minimum spacing	S_{min}	[mm]	100	100	100	120
Minimum edge distance	C_{min}	[mm]	50	50	50	60
Minimum element thickness	h_{min}	[mm]	$h_{nom} + c_{nom}^*$			

h_{nom} : embedment depth; c_{nom} : concrete cover

* c_{nom} acc. to EN 1992-1 with $c_{nom} \geq 20$ mm

For fixing anchors made of stainless steel a minimum concrete cover $c_{nom} = 20$ mm is sufficient.

T-FIXX A4



T-FIXX A4

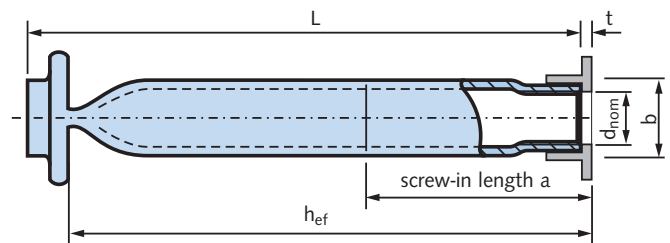

Anchor description

The T-FIXX A4 is manufactured from a stainless steel tube (strength class A4-50).

The internal thread is metric ISO.

For identification a white plastic data clip is attached ($t=2$ mm).



Please download our calculation software to calculate the load capacity of this anchor according to CEN/TS 1992-4-1/2.

www.halfen.de → service → software.

For information about our software see page 39.

T-FIXX A4 incl. data clip (white)

Order no.	Dimensions				Design loads for tension ^①		
	$d_{nom} \times L$	h_{ef}	a	b	$N_{Rd,c}$ [kN]	$N_{Rd,c}$ [kN]	$N_{Rd,s}$ [kN]
	[mm]	[mm]	[mm]	[mm]	C20/25	C45/55	Steel
0020.270-00101	M10 × 50	43.7	32	13.5	8.2	8.9	8.9
0020.270-00102	M10 × 65	58.7	32	13.5	8.9	8.9	8.9
0020.270-00103	M12 × 50	42.5	30	17.2	7.9	11.6	15.6
0020.270-00104	M12 × 70	62.5	38	17.2	14.0	15.6	15.6
0020.270-00105	M12 × 115	107.5	38	17.2	15.6	15.6	15.6
0020.270-00106	M16 × 60	51.3	32	21.3	10.4	15.4	25.0
0020.270-00107	M16 × 80	71.3	50	21.3	17.1	25.0	25.0
0020.270-00108	M16 × 110	101.3	50	21.3	25.0	25.0	25.0
0020.270-00109	M20 × 70	61.2	44	26.9	13.6	20.1	32.3
0020.270-00110	M20 × 100	91.2	62	26.9	24.7	32.3	32.3
0020.270-00111	M20 × 125	116.2	62	26.9	32.3	32.3	32.3

① The design load is the calculation value according to CEN/TS 1992-4-1/2 for normal tensile force in plain concrete without load-reducing influences. Values only apply for cracked concrete; no dense reinforcement (risk of shell spalling). Design loads are valid for (structural) fixings and are not permitted for lifting!

BOLT ANCHORS

Bolt Anchor 1988 GV



1988 GV

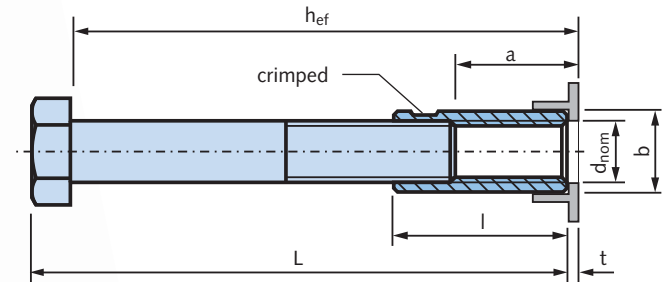

Anchor description

The bolt anchor 1988 GV consists of a bolt (untreated, quality 8.8) with screwed and crimped sleeve. The sleeve with internal metric ISO thread is zinc galvanised (GV). The sleeve is manufactured from a steel precision tube. For identification a grey plastic data clip is attached ($t=2\text{ mm}$).



Please download our calculation software to calculate the load capacity of this anchor according to CEN/TS 1992-4-1/2.

www.halfen.de → service → software.

For information about our software see page 39.

Bolt anchor 1988 GV incl. data clip (grey)

Order no.	Dimensions					Design loads for tension ^①		
	$d_{\text{nom}} \times L$ [mm]	h_{ef} [mm]	a [mm]	b [mm]	l [mm]	$N_{\text{Rd,c}}$ [kN]	$N_{\text{Rd,c}}$ [kN]	$N_{\text{Rd,s}}$ [kN]
						C20/25	C45/55	Steel
0020.010-00048	M12 x 55	49.0	25	15.5	35	9.7	14.4	28.9
0020.010-00001	M12 x 100	94.0	25	15.5	35	16.7	28.9	28.9
0020.010-00002	M12 x 150	144.0	25	15.5	35	16.7	28.9	28.9
0020.010-00049	M16 x 75	67.0	31	21	45	15.5	23.1	58.8
0020.010-00003	M16 x 140	132.0	31	21	45	29.8	58.8	58.8
0020.010-00004	M16 x 220	212.0	31	21	45	29.8	58.8	58.8
0020.010-00068	M20 x 90	79.0	37	26	55	19.9	29.5	88.2
0020.010-00005	M20 x 150	139.0	37	26	55	46.4	68.9	88.2
0020.010-00006	M20 x 180	169.0	37	26	55	46.5	88.2	88.2
0020.010-00007	M20 x 270	259.0	37	26	55	46.5	88.2	88.2
0020.010-00069	M24 x 110	97.0	48	32	70	27.1	40.2	138.7
0020.010-00008	M24 x 200	187.0	48	32	70	67.0	107.5	138.7
0020.010-00009	M24 x 320	307.0	48	32	70	67.0	138.7	138.7
0020.010-00070	M30 x 160	143.0	62	40	90	48.5	71.9	211.7
0020.010-00010	M30 x 240	223.0	62	40	90	94.4	140.0	211.7
0020.010-00011	M30 x 380	363.0	62	40	90	112.6	211.7	211.7
0020.010-00012	M36 x 300	279.0	76	47.5	110	132.0	195.9	309.8
0020.010-00013	M36 x 420	399.0	76	47.5	110	160.2	309.8	309.8
0020.010-00014	M42 x 300	276.0	70	54	110	129.9	192.7	371.5
0020.010-00015	M42 x 460	436.0	70	54	110	227.4	371.5	371.5

① The design load is the calculation value according to CEN/TS 1992-4-1/2 for normal tensile force in plain concrete without load-reducing influences. Values only apply for cracked concrete; no dense reinforcement (risk of shell spalling). Design loads are valid for (structural) fixings and are not permitted for lifting!

BOLT ANCHORS

Bolt Anchor 1988 FV

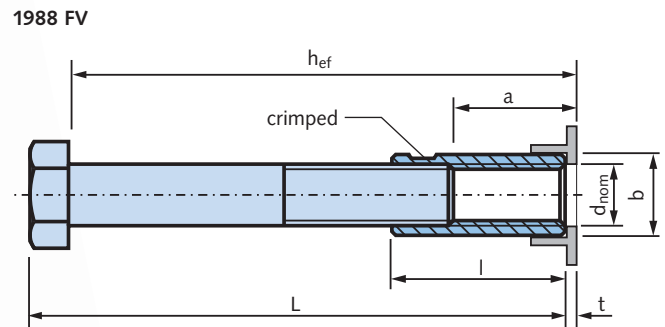

Anchor description

The bolt anchor 1988 FV consists of a bolt (untreated, quality 8.8) with a screwed and crimped sleeve. The sleeve with internal metric ISO thread is hot-dipped galvanised (FV) and manufactured from a steel precision tube.

For identification a grey plastic data clip is attached ($t=2$ mm).



Please download our calculation software to calculate the load capacity of this anchor according to CEN/TS 1992-4-1/2.

www.halfen.de → service → software.

For information about our software see page 39.

Bolt anchor 1988 FV incl. data clip (grey)

Order no.	Dimensions					Design loads for tension ^①		
	$d_{nom} \times L$ [mm]	h_{ef} [mm]	a [mm]	b [mm]	l [mm]	$N_{Rd,c}$ [kN]	$N_{Rd,c}$ [kN]	$N_{Rd,s}$ [kN]
						C20/25	C45/55	Steel
0020.010-00071	M12 x 55	49.0	25	15.5	35	9.7	14.4	28.9
0020.010-00032	M12 x 100	94.0	25	15.5	35	16.7	28.9	28.9
0020.010-00033	M12 x 150	144.0	25	15.5	35	16.7	28.9	28.9
0020.010-00072	M16 x 75	67.0	31	21	45	15.5	23.1	58.8
0020.010-00034	M16 x 140	132.0	31	21	45	29.8	58.8	58.8
0020.010-00035	M16 x 220	212.0	31	21	45	29.8	58.8	58.8
0020.010-00073	M20 x 90	79.0	37	26	55	19.9	29.5	88.2
0020.010-00036	M20 x 150	139.0	37	26	55	46.4	68.9	88.2
0020.010-00037	M20 x 180	169.0	37	26	55	46.5	88.2	88.2
0020.010-00038	M20 x 270	259.0	37	26	55	46.5	88.2	88.2
0020.010-00074	M24 x 110	97.0	48	32	70	27.1	40.2	138.7
0020.010-00039	M24 x 200	187.0	48	32	70	67.0	107.5	138.7
0020.010-00040	M24 x 320	307.0	48	32	70	67.0	138.7	138.7
0020.010-00075	M30 x 160	143.0	62	40	90	48.5	71.9	211.7
0020.010-00041	M30 x 240	223.0	62	40	90	94.4	140.0	211.7
0020.010-00042	M30 x 380	363.0	62	40	90	112.6	211.7	211.7
0020.010-00044	M36 x 420	399.0	76	47.5	110	160.2	309.8	309.8

① The design load is the calculation value according to CEN/TS 1992-4-1/2 for normal tensile force in plain concrete without load-reducing influences. Values only apply for cracked concrete; no dense reinforcement (risk of shell spalling). Design loads are valid for (structural) fixings and are not permitted for lifting!

BOLT ANCHORS

Bolt Anchor 1988 A4-50 / A4-80



1988 A4-50 and 1988 A4-80

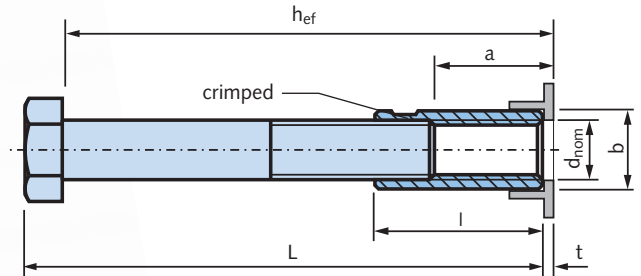

Anchor description

The bolt anchor 1988 A4 consists of a bolt (hot-dipped galvanized, quality 8.8) with a screwed and crimped sleeve. The sleeve has an internal metric ISO thread and is manufactured from stainless steel (strength class A4-50 or strength class A4-80). For identification a white/black plastic data clip is attached ($t=2$ mm).

Sealing

For bolt anchors 1988 A4-50 respect. A4-80 subject to increased corrosion exposure, the bolt anchors have to be ordered with special sealing on the bottom of the sleeve.

Conditions for increased corrosion exposure are:
 High exposure to chlorides, e. g. inshore (≤ 1 km) or next to roads with road salt application (≤ 10 m); exposure to acids ($\text{pH} \leq 3$); medium exposure to sulfur, nitrogen (industrial area); non-accessible structures (e. g. rear ventilated facades).



Please download our calculation software to calculate the load capacity of this anchor according to CEN/TS 1992-4-1/2.

Bolt anchor 1988 A4-50 incl. data clip (white)

Order no.	Dimensions					Design loads for tension ^①		
	$d_{\text{nom}} \times L$ [mm]	h_{ef} [mm]	a ^② [mm]	b [mm]	l [mm]	$N_{\text{Rd,c}}$ [kN]	$N_{\text{Rd,c}}$ [kN]	$N_{\text{Rd,s}}$ [kN]
						C20/25	C45/55	Steel
0020.010-00060	M12 x 100	94.0	25	16	35	15.0	15.0	15.0
0020.010-00061	M12 x 150	144.0	25	16	35	15.0	15.0	15.0
0020.010-00062	M16 x 140	132.0	31	21.3	45	26.2	26.2	26.2
0020.010-00063	M16 x 220	212.0	31	21.3	45	26.2	26.2	26.2
0020.010-00064	M20 x 150	139.0	37	26	55	35.6	35.6	35.6
0020.010-00065	M20 x 180	169.0	37	26	55	35.6	35.6	35.6
0020.010-00066	M20 x 270	259.0	37	26	55	35.6	35.6	35.6

Bolt anchor 1988 A4-80 incl. data clip (black)

0020.010-00016	M12 x 100	94.0	25	15.5	35	16.7	36.8	40.0
0020.010-00017	M12 x 150	144.0	25	15.5	35	16.7	36.8	40.0
0020.010-00018	M16 x 140	132.0	31	21	45	29.8	63.7	81.3
0020.010-00019	M16 x 220	212.0	31	21	45	29.8	65.5	81.3
0020.010-00020	M20 x 150	139.0	37	26	55	46.5	68.9	121.9
0020.010-00021	M20 x 180	169.0	37	26	55	46.5	92.3	121.9
0020.010-00067	M20 x 270	259.0	37	26	55	46.5	102.4	121.9
0020.010-00022	M24 x 200	187.0	48	32	70	67.0	107.5	188.3
0020.010-00023	M30 x 240	223.0	62	40	90	94.4	140.0	292.7

① The design load is the calculation value according to CEN/TS 1992-4-1/2 for normal tensile force in plain concrete without load-reducing influences.

Values only apply for cracked concrete; no dense reinforcement (risk of shell spalling).

Design loads are valid for (structural) fixings and are not permitted for lifting!

② For bolt anchors with a sealing on bottom of the sleeve the dimension a has to be reduced by 3 mm.

BOLT ANCHORS

Bolt Anchor 1985 GV

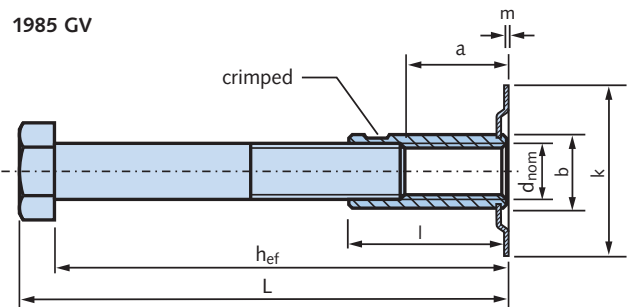

Anchor description

The bolt anchor 1985 GV is a similar anchor to type 1988 GV but with additional nailing plate (to fix the anchor to formwork). The sleeve is zinc galvanized (GV), the internal thread is metric ISO.



Please download our calculation software to calculate the load capacity of this anchor according to CEN/TS 1992-4-1/2.

www.halfen.de → service → software.

For information about our software see page 39.

Bolt anchor 1985 GV

Order no.	Dimensions							Design loads for tension ^①		
	$d_{nom} \times L$	h_{ef}	a	b	l	k	m	$N_{Rd,c}$ [kN]	$N_{Rd,c}$ [kN]	$N_{Rd,s}$ [kN]
	[mm]	[mm]	[mm]	[mm]	[mm]	[mm]	[mm]	C20/25	C45/55	Steel
0020.020-00001	M12 × 150	142.0	23	15.5	35	40	1.0	16.7	28.9	28.9
0020.020-00002	M16 × 140	130.0	29	21	45	44	1.5	29.8	58.8	58.8
0020.020-00003	M20 × 180	167.0	35	26	55	48	1.5	46.5	88.2	88.2
0020.020-00004	M24 × 200	185.0	46	32	70	57	1.5	67.0	107.5	138.7

① The design load is the calculation value according to CEN/TS 1992-4-1/2 for normal tensile force in plain concrete without load-reducing influences.

Values only apply for cracked concrete; no dense reinforcement (risk of shell spalling).

Design loads are valid for (structural) fixings and are not permitted for lifting!

Minimum allowed element thickness, minimum edge distances and spacing

Installation parameters / arrangement of bolt anchors 1988 and 1985:

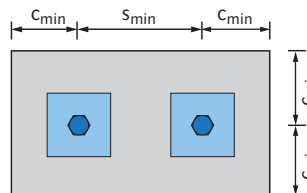

Top view: Concrete member with 2 fixing anchors embedded.

Thread size	d	[mm]	M 12	M 16	M 20	M 24	M 30	M 36	M 42
Minimum spacing	s_{min}	[mm]	100	100	120	150	180	220	260
Minimum edge distance	c_{min}	[mm]	50	50	60	75	90	110	130
Minimum element thickness	h_{min}	[mm]	$h_{nom} + c_{nom}$ ^①						

h_{nom} : embedment depth; c_{nom} : concrete cover

① c_{nom} acc. to EN 1992-1 with $c_{nom} \geq 20$ mm

BOLT ANCHORS

Plate Anchor 1980-P GV / FV



1980-P GV / FV

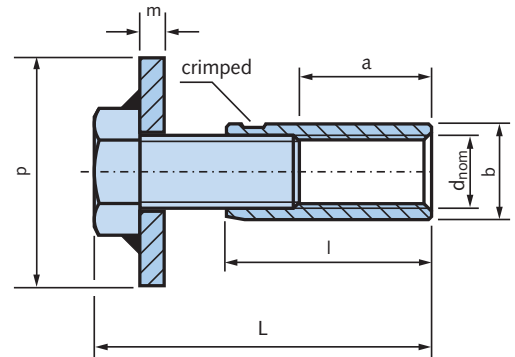

Anchor description

The plate anchors 1980-P GV and 1980-P FV consist of a bolt (untreated, quality 8.8) and a square washer (untreated, according to DIN 436) welded together underneath the head of the bolt. The bolt is connected to

a screwed on and crimped sleeve with internal metric ISO thread. The surface treatment is either zinc galvanised (GV) or hot-dipped galvanised (FV). The sleeve is manufactured from a steel precision tube.



Please download our calculation software to calculate the load capacity of this anchor according to CEN/TS 1992-4-1/2. www.halfen.de → service → software. For information about our software see page 39.

Plate anchor 1980-P GV

Order no.	Dimensions							Design loads for tension ^①		
	$d_{nom} \times L$	h_{ef}	a	b	l	p	m	$N_{Rd,c}$ [kN]	$N_{Rd,c}$ [kN]	$N_{Rd,s}$ [kN]
	[mm]	[mm]	[mm]	[mm]	[mm]	[mm]	[mm]	C20/25	C45/55	Steel
0020.200-00001	M12 x 55	49.0	23	15.5	35	40	4	9.7	14.4	28.9
0020.200-00002	M16 x 75	68.0	29	21	45	50	5	15.9	23.6	58.9
0020.200-00003	M20 x 90	81.0	35	26	55	60	5	20.7	30.6	88.2
0020.200-00004	M24 x 110	100.0	46	32	70	80	6	28.3	42.0	138.7
0020.200-00005	M30 x 140	127.0	60	40	90	95	6	40.5	60.1	211.7

Plate anchor 1980-P FV

0020.200-00016	M12 x 55	49.0	23	15.5	35	40	4	9.7	14.4	28.9
0020.200-00017	M16 x 75	68.0	29	21	45	50	5	15.9	23.6	58.8
0020.200-00018	M20 x 90	81.0	35	26	55	60	5	20.7	30.6	88.2
0020.200-00019	M24 x 110	100.0	46	32	70	80	6	28.3	42.0	138.7
0020.200-00020	M30 x 140	127.0	60	40	90	95	6	40.5	60.1	211.7

① The design load is the calculation value according to CEN/TS 1992-4-1/2 for normal tensile force in plain concrete without limitation of centre to centre distances, edge distances and element height (→ see explanation on page 19)! Values only apply for cracked concrete; no dense reinforcement (risk of shell spalling). Design loads are valid for (structural) fixings and are not permitted for lifting!

BOLT ANCHORS

Plate Anchor 1980-P A4-80



1980-P A4-80

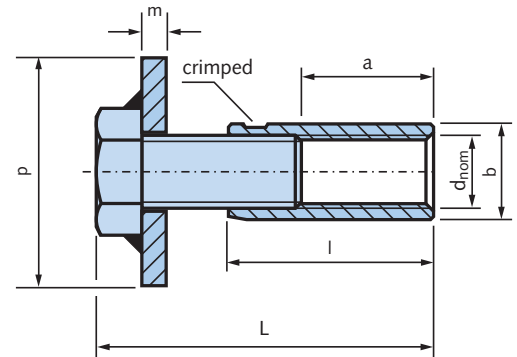

Anchor description

The plate anchor 1980-P A4-80 consists of a bolt (untreated, quality 8.8) and a square washer (untreated, according DIN 436) welded together underneath the head of the bolt. The bolt is connected to a screwed

and crimped sleeve with internal metric ISO thread. The sleeve is manufactured from a stainless steel precision tube (strength class A4-80).



Please download our calculation software to calculate the load capacity of this anchor according to CEN/TS 1992-4-1/2. www.halfen.de → service → software. For information about our software see page 39.

Plate anchor 1980-P A4-80

Order no.	Dimensions							Design loads for tension ^①		
	$d_{nom} \times L$	h_{ef}	a	b	l	p	m	$N_{Rd,c}$ [kN]	$N_{Rd,c}$ [kN]	$N_{Rd,s}$ [kN]
	[mm]	[mm]	[mm]	[mm]	[mm]	[mm]	[mm]	C20/25	C45/55	Steel
0020.200-00011	M12 × 55	49.0	23	15.5	35	40	4	9.7	14.4	40.0
0020.200-00012	M16 × 75	68.0	29	21	45	50	5	15.9	23.6	81.3
0020.200-00013	M20 × 90	81.0	35	26	55	60	5	20.7	30.6	121.9
0020.200-00014	M24 × 110	100.0	46	32	70	80	6	28.3	42.0	188.3
0020.200-00015	M30 × 140	127.0	60	40	90	95	6	40.5	60.1	292.7

① The design load is the calculation value according to CEN/TS 1992-4-1/2 for normal tensile force in plain concrete without limitation of centre to centre distances, edge distances and element height (→ see explanation below)! Values only apply for cracked concrete; no dense reinforcement (risk of shell spalling). Design loads are valid for (structural) fixings and are not permitted for lifting!

Example of fixing anchors embedded in full concrete

Example of fixing anchors embedded in full concrete without any influence of edge distances (c), centre to centre distances (s), etc.

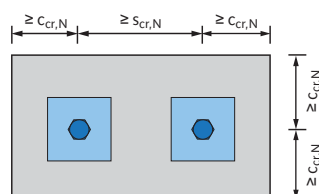

Top view: Concrete member with 2 fixing anchors, embedded in full concrete.

Conditions (fixing anchors loaded by tension)

$$c_{cr,N} \geq 1.5 \times h_{ef}$$

$$s_{cr,N} \geq 3.0 \times h_{ef}$$



The given conditions are valid for cracked concrete and present reinforcement, which resists the splitting forces (limiting the crack width to $w_k \leq 0.3$ mm).

BAR ANCHORS

Bar Anchor 4010 GV

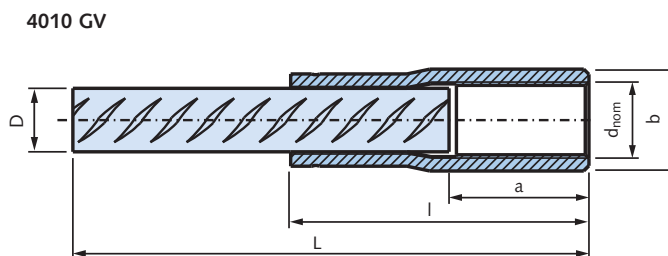

Anchor description

The bar anchor 4010 GV consists of a rebar B500B (untreated) according to EN 10080 (NEN 6008) with crimped sleeve. The sleeve has a metric ISO thread and is zinc galvanised (GV).

Bar anchor 4010 GV							
Order no.	Dimensions						Design loads ^②
	$d_{nom} \times L$ [mm]	D [mm]	a [mm]	b [mm]	l [mm]	A_s ^① [mm ²]	$N_{Rd,s}$ [kN] Steel
0052.070-00001	M16 × 415	12	25	21	58	113	48
0052.070-00002	M16 × 615	12	25	21	58	113	48
0052.070-00003	M16 × 840	12	25	21	58	113	48
0052.070-00022	M16 × 1040	12	25	21	58	113	48
0052.070-00004	M16 × 1540	12	25	21	58	113	48
0052.070-00024	M16 × 2040	12	25	21	58	113	48
0052.070-00006	M20 × 560	16	33	26	71	201	86
0052.070-00007	M20 × 810	16	33	26	71	201	86
0052.070-00008	M20 × 1060	16	33	26	71	201	86
0052.070-00009	M20 × 1480	16	33	26	71	201	86
0052.070-00025	M20 × 2240	16	33	26	71	201	86
0052.070-00026	M20 × 3540	16	33	26	71	201	86
0052.070-00011	M24 × 705	20	38	32	90	314	136
0052.070-00012	M24 × 1005	20	38	32	90	314	136
0052.070-00013	M24 × 1320	20	38	32	90	314	136
0052.070-00014	M24 × 1840	20	38	32	90	314	136
0052.070-00027	M24 × 2245	20	38	32	90	314	136
0052.070-00032	M24 × 3540	20	38	32	90	314	136
0052.070-00016	M30 × 1055	25	48	40	114	491	213
0052.070-00017	M30 × 1555	25	48	40	114	491	213
0052.070-00018	M30 × 2315	25	48	40	114	491	213
0052.070-00033	M30 × 3555	25	48	40	114	491	213
0052.070-00030	M42 × 1015	32	65	54	140	804	348
0052.070-00020	M42 × 1490	32	65	54	140	804	348
0052.070-00021	M42 × 2390	32	65	54	140	804	348
0052.070-00034	M42 × 3590	32	65	54	140	804	348

① A_s : stress area of the reinforcement bar in mm².

② Design loads are for tension and are the maximum values (yield strength) for pure steel of the rebars: $N_{Rd,s} = A_s \times f_{yd}$ ($f_{yd} = f_{yk} / 1.15$). In addition the load capacity of the bar anchor embedded in concrete has to be checked for accordance with EN 1992-1-1, chapter 8.4 (NEN 6720 art. 9.6 and 9.16). The required bonding strength depends strongly on the strength class of the concrete and has to be verified.

BAR ANCHORS

Bar Anchor 4010 FV

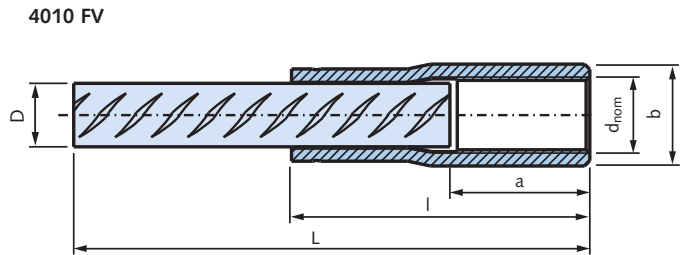

Anchor description

The bar anchor 4010 FV consists of a rebar B500B (untreated) according to EN 10080 (NEN 6008) with a crimped sleeve. The sleeve has a metric ISO thread and is hot-dipped galvanised (FV).

Bar anchor 4010 FV

Order no.	Dimensions						Design loads ^②
	$d_{nom} \times L$ [mm]	D [mm]	a [mm]	b [mm]	l [mm]	A_s ^① [mm ²]	$N_{Rd,s}$ [kN] Steel
0052.070-00110	M16 × 415	12	25	21	58	113	48
0052.070-00114	M16 × 615	12	25	21	58	113	48
0052.070-00111	M20 × 560	16	33	26	71	201	86
0052.070-00115	M20 × 810	16	33	26	71	201	86
0052.070-00112	M24 × 705	20	38	32	90	314	136
0052.070-00116	M24 × 1005	20	38	32	90	314	136
0052.070-00113	M30 × 1055	25	48	40	114	491	213
0052.070-00117	M30 × 1555	25	48	40	114	491	213
0052.070-00118	M42 × 1015	32	65	54	140	804	348
0052.070-00119	M42 × 1490	32	65	54	140	804	348

① A_s : stress area of the reinforcement bar in mm².

② Design loads are for tension and are the maximum values (yield strength) for pure steel of the rebars: $N_{Rd,s} = A_s \times f_{yd}$ ($f_{yd} = f_{yk} / 1.15$). In addition the load capacity of the bar anchor embedded in concrete has to be checked for accordance with EN 1992-1-1, chapter 8.4 (NEN 6720 art. 9.6 and 9.16). The required bonding strength depends strongly on the strength class of the concrete and has to be verified.

Technical Notes

According to the dutch standard NEN 6146 "steel bars for the reinforcement of concrete", the rebars of the bar anchors must be manufactured with a tolerance of +5 mm / -2 × diameter (of rebar) → the existing bonding length of the bar anchors can be calculated as follows:

$$L_{bd} = L - l - 2 \times D \text{ [mm]}$$

with

$$L_{bd} = \text{bonding length [mm]}$$

$$L = \text{total length of bar anchor [mm]}$$

$$l = \text{length of sleeve [mm]}$$

$$D = \text{diameter of rebar [mm]}$$

BAR ANCHORS

Bar Anchor 3016 GV



Anchor description

The bar anchor 3016 GV consists of a rebar B500B (untreated) according to EN 10080 (NEN 6008) with a screwed and crimped sleeve and with additional nailing plate (to fix the anchor to the formwork).

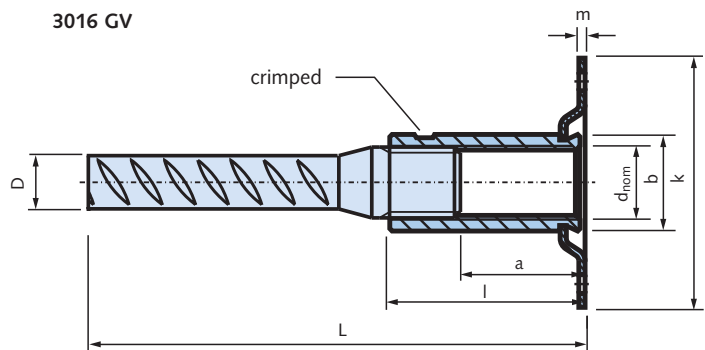

The sleeve is zinc galvanised (GV), the internal thread is metric ISO.

The maximum screw-in length for bolts is longer compared to the bar anchor 4010 → see table below.

Bar anchor 3016 GV									
Order no.	Dimensions								Design loads ^②
	$d_{nom} \times L$ [mm]	D [mm]	a [mm]	b [mm]	l [mm]	k [mm]	m [mm]	A_s ^① [mm ²]	$N_{Rd,s}$ [kN] Steel
0052.090-00001	M16 × 410	12	29	21	45	44	1.5	113	48
0052.090-00002	M20 × 565	16	35	26	55	48	1.5	201	86
0052.090-00003	M24 × 715	20	46	32	70	57	1.5	314	136

① A_s : stress area of the reinforcement bar in mm².
 ② Design loads are for tension and are the maximum values (yield strength) for pure steel of the rebars: $N_{Rd,s} = A_s \times f_{yd}$ ($f_{yd} = f_{yk} / 1.15$).
 In addition the load capacity of the bar anchor embedded in concrete has to be checked for accordance with EN 1992-1-1, chapter 8.4 (NEN 6720 art. 9.6 and 9.16). The required bonding strength depends strongly on the strength class of the concrete and has to be verified.

Technical Notes

According to the dutch standard NEN 6146 "steel bars for the reinforcement of concrete", the rebars of the bar anchors are manufactured with an allowable tolerance of +5 mm / -2 × diameter (of rebar) → the existing bonding length of the bar anchors can be calculated as follows:

$$L_{bd} = L - l - 2 \times D \text{ [mm]}$$

with

L_{bd} = bonding length [mm]

L = total length of bar anchor [mm]

l = length of sleeve [mm]

D = diameter of rebar [mm]

BAR ANCHORS

Bar Anchor 3010 A4-80



3010 A4-80

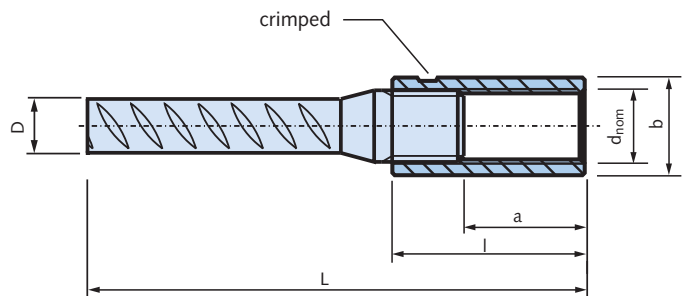

Anchor description

The bar anchor 3010 A4-80 consists of a rebar B500B (untreated) according to EN 10080 (NEN 6008) with a screwed and crimped sleeve.

The sleeve has a metric ISO thread and is made of stainless steel (strength class A4-80).

Bar anchor 3010 A4-80

Order no.	Dimensions						Design loads ^②
	$d_{nom} \times L$ [mm]	D [mm]	a [mm]	b [mm]	l [mm]	A_s ^① [mm ²]	$N_{Rd,s}$ [kN] Steel
0052.030-00006	M16 × 410	12	29	21	45	113	48
0052.030-00007	M20 × 565	16	35	26	55	201	86
0052.030-00008	M24 × 715	20	46	32	70	314	136
0052.030-00009	M30 × 1055	25	60	40	90	491	213

① A_s : stress area of the reinforcement bar in mm².

② Design loads are for tension and are the maximum values (yield strength) for pure steel of the rebars: $N_{Rd,s} = A_s \times f_{yd}$ ($f_{yd} = f_{yk} / 1.15$). In addition the load capacity of the bar anchor embedded in concrete has to be checked for accordance with EN 1992-1-1, chapter 8.4 (NEN 6720 art. 9.6 and 9.16). The required bonding strength depends strongly on the strength class of the concrete and has to be verified.

Technical Notes

According to the dutch standard NEN 6146 "steel bars for the reinforcement of concrete", the rebars of the bar anchors are manufactured with an allowable tolerance of +5 mm / -2 × diameter (of rebar) → the existing bonding length for bar anchors can be calculated as follows:

$$L_{bd} = L - l - 2 \times D \text{ [mm]}$$

with

$$L_{bd} = \text{bonding length [mm]}$$

$$L = \text{total length of bar anchor [mm]}$$

$$l = \text{length of sleeve [mm]}$$

$$D = \text{diameter of the rebar [mm]}$$

BAR ANCHORS

Bar Anchor 1980-S GV

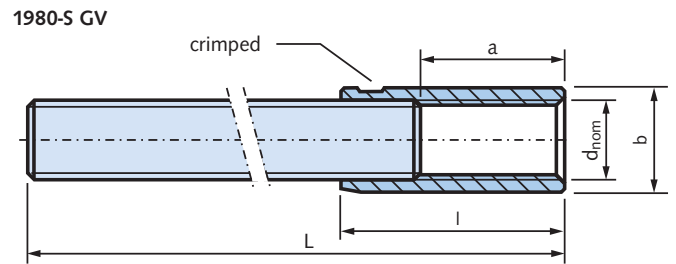

Anchor description

The bar anchor 1980-S GV consists of a threaded rod (untreated, quality 4.6) with a screwed and crimped sleeve. The sleeve has a metric ISO thread and the surface is zinc galvanised (GV).

Alternatively sleeves are available on request as hot-dipped galvanised or in stainless steel.

Bar anchor 1980-S GV						
Order no.	Dimensions					Design loads ^②
	$d_{nom} \times L$ [mm]	a [mm]	b [mm]	l [mm]	A_s ^① [mm ²]	$N_{Rd,s}$ [kN] Steel
0020.210-00001	M12 x 400	23	15.5	35	84	17
0020.210-00002	M12 x 600	23	15.5	35	84	17

① A_s : stress area of screwed in bolt/bar in mm².
 ② Design loads are for tension and are the maximum values for pure steel of the threaded bars.
 In addition the load capacity of the bar anchor embedded in concrete has to be checked for accordance with EN 1992-1-1, chapter 8.4 (NEN 6720 art. 9.6 and 9.16).
 The required bonding strength depends strongly on the strength class of the concrete and has to be verified.

Technical Notes

The existing bonding length of bar anchors can be calculated as follows:

$$L_{bd} = L - l \text{ [mm]}$$

with

$$L_{bd} = \text{bonding length [mm]}$$

$$L = \text{total length of bar anchor [mm]}$$

$$l = \text{length of sleeve [mm]}$$

BAR ANCHORS

Bar Anchor 1988-S GV

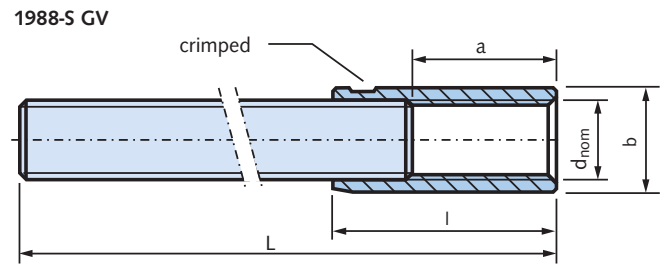

Anchor description

The bar anchor 1988-S GV consists of a threaded rod (untreated, quality 8.8) with a screwed and crimped sleeve. The sleeve has a metric ISO thread and the surface is zinc galvanised (GV).

Alternatively sleeves are available on request as hot-dipped galvanised or in stainless steel.

Bar anchor 1988-S GV						
Order no.	Dimensions					Design loads ^②
	$d_{nom} \times L$ [mm]	a [mm]	b [mm]	l [mm]	A_s ^① [mm ²]	$N_{Rd,s}$ [kN] Steel
0020.210-00101	M12 x 435	23	15.5	35	84	33
0020.210-00102	M12 x 635	23	15.5	35	84	33
0020.210-00103	M16 x 585	29	21	45	161	63
0020.210-00104	M20 x 735	35	26	55	245	96

① A_s : stress area of the threaded connector in mm².
 ② Design loads are for tension and are the maximum values for pure steel of the threaded connectors. In addition the load capacity of the bar anchor embedded in concrete has to be checked for accordance with EN 1992-1-1, chapter 8.4 (NEN 6720 art. 9.6 and 9.16). The required bonding strength depends strongly on the strength class of the concrete and has to be verified.

Technical Notes

The existing bonding length of bar anchors can be calculated as follows:

$$L_{bd} = L - l \text{ [mm]}$$

with

$$L_{bd} = \text{bonding length [mm]}$$

$$L = \text{total length of bar anchor [mm]}$$

$$l = \text{length of sleeve [mm]}$$

BAR ANCHORS

Bar Anchor 4030 GV / FV



4030 GV/FV

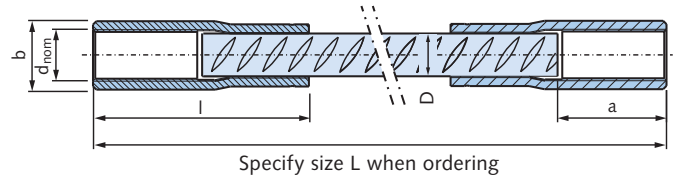

Anchor description

The special bar anchors 4030 GV and 4030 FV consist of a rebar B500B (untreated) according to EN 10080 (NEN 6008) with a crimped sleeve on both ends.

The sleeves have metric ISO threads and are available either in zinc galvanised (GV) or hot-dipped galvanised (FV).

This product is made on request; please specify required length when ordering.

Bar anchor 4030 GV

Order no.	Dimensions					Design loads ^②	
	$d_{nom} - D$ [mm]	L min [mm]	a [mm]	b [mm]	l [mm]	A_s ^① [mm ²]	$N_{Rd,s}$ [kN] Steel
0052.159-00001	M16 - Ø12	225	25	21	58	113	48
0052.159-00002	M20 - Ø16	233	33	26	71	201	86
0052.159-00003	M24 - Ø20	238	38	32	90	314	136
0052.159-00004	M30 - Ø25	338	48	40	114	491	213
0052.159-00005	M42 - Ø32	395	65	54	140	804	348

Bar anchor 4030 FV

0052.159-00011	M16 - Ø12	225	25	21	58	113	48
0052.159-00012	M20 - Ø16	233	33	26	71	201	86
0052.159-00013	M24 - Ø20	238	38	32	90	314	136
0052.159-00014	M30 - Ø25	338	48	40	114	491	213
0052.159-00015	M42 - Ø32	395	65	54	140	804	348

① A_s : stress area of the reinforcement bar in mm².

② Design loads are for tension and are the maximum values for pure steel of the rebars: $N_{Rd,s} = A_s \times f_{yd}$ ($f_{yd} = f_{yk} / 1.15$).

In addition the load capacity of the bar anchor embedded in concrete has to be checked for accordance with EN 1992-1-1, chapter 8.4 (NEN 6720 art. 9.6 and 9.16).

The required bonding strength depends strongly on the strength class of the concrete and has to be verified.

BAR ANCHORS

Spacer 1554 GV / FV

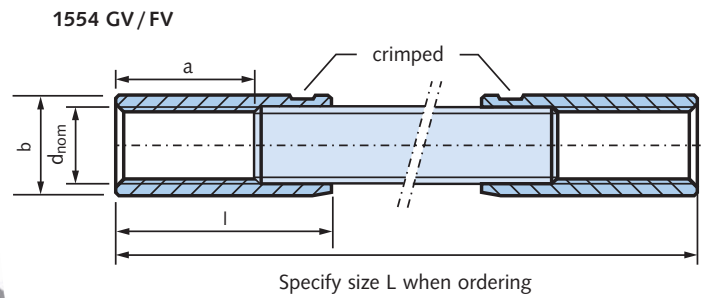

Anchor description

The bar anchors 1554 GV and 1554 FV consist of a threaded rod (untreated, quality 4.6) with screwed and crimped sleeves on both ends. The sleeves have metric ISO threads and are available with a surface treatment either in zinc galvanised (GV) or in hot-dipped galvanised (FV).

This product is made on request; please specify required length when ordering.

Spacer 1554 GV

Order no.	Dimensions						Design loads ^②
	d _{nom} [mm]	L min [mm]	a [mm]	b [mm]	l [mm]	A _s ^① [mm ²]	N _{Rd,s} [kN] Steel
0020.229-00001	M12	200	23	15.5	35	84	17
0020.229-00002	M16	200	29	21	45	157	31
0020.229-00003	M20	200	35	26	55	245	49
0020.229-00004	M24	200	46	32	70	355	71
0020.229-00005	M30	220	60	40	90	560	112
0020.229-00006	M36	250	74	47.5	110	817	163
0020.229-00007	M42	250	68	54	110	1122	224

Spacer 1554 FV

0020.229-00011	M12	200	23	15.5	35	84	17
0020.229-00012	M16	200	29	21	45	157	31
0020.229-00013	M20	200	35	26	55	245	49
0020.229-00014	M24	200	46	32	70	355	71
0020.229-00015	M30	220	60	40	90	560	112
0020.229-00016	M36	250	74	47.5	110	817	163
0020.229-00017	M42	250	68	54	110	1122	224

① A_s: stress area of screwed in bolt/bar in mm².

② Design loads are for tension and are the maximum values for pure steel of the threaded bars. In addition the load capacity of the bar anchor embedded in concrete has to be checked for accordance with EN 1992-1-1, chapter 8.4 (NEN 6720 art. 9.6 and 9.16). The required bonding strength depends strongly on the strength class of the concrete and has to be verified.

BAR ANCHORS

Spacer 1554 A4-80

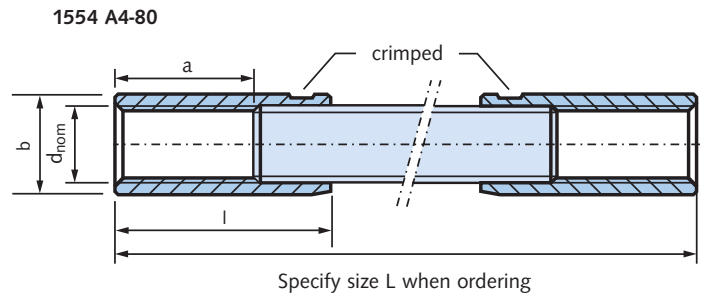

Anchor description

The bar anchor 1554 A4-80 consists of a threaded rod (untreated, quality 4.6) with screwed and crimped sleeves on both ends. The sleeves have metric ISO threads and are made of stainless steel (strength class A4-80).

This product is made to order; please specify required length when ordering.

Spacer 1554 A4-80

Order no.	Dimensions						Design loads ^②
	d_{nom} [mm]	L min [mm]	a [mm]	b [mm]	l [mm]	A_s ^① [mm ²]	$N_{Rd,s}$ [kN] Steel
0020.229-00021	M12	200	23	15.5	35	84	17
0020.229-00022	M16	200	29	21	45	157	31
0020.229-00023	M20	200	35	26	55	245	49
0020.229-00024	M24	200	46	32	70	355	71
0020.229-00025	M30	220	60	40	90	560	112

① A_s : stress area of screwed in bolt/bar in mm².

② Design loads are for tension and are the maximum values for pure steel of the threaded bars.

In addition the load capacity of the bar anchor embedded in concrete has to be checked for accordance with EN 1992-1-1, chapter 8.4 (NEN 6720 art. 9.6 and 9.16).

The required bonding strength depends strongly on the strength class of the concrete and has to be verified.

BAR ANCHORS

Spacer 1558 GV / FV

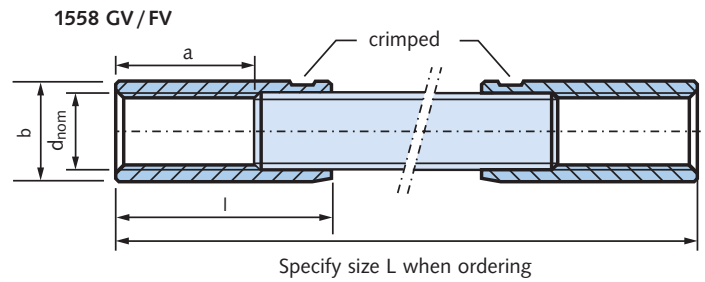

Anchor description

The bar anchors 1558 GV and 1558 FV consist of a threaded rod (untreated, quality 8.8) with screwed and crimped sleeves on both ends. The sleeves have metric ISO threads and are available either zinc galvanised (GV) or hot-dipped galvanised (FV).

This product is made on request; please specify required length when ordering.

Spacer 1558 GV

Order no.	Dimensions						Design loads ^②
	d _{nom} [mm]	L min [mm]	a [mm]	b [mm]	l [mm]	A _s ^① [mm ²]	N _{Rd,s} [kN] Steel
0020.229-00101	M12	200	23	15.5	35	84	33
0020.229-00102	M16	200	29	21	45	161	63
0020.229-00103	M20	200	35	26	55	245	96
0020.229-00104	M24	200	46	32	70	385	150
0020.229-00105	M30	220	60	40	90	605	237
0020.229-00106	M36	250	74	47.5	110	826	323
0020.229-00107	M42	250	68	54	110	1002	392

Spacer 1558 FV

0020.229-00111	M12	200	23	15.5	35	84	33
0020.229-00112	M16	200	29	21	45	161	63
0020.229-00113	M20	200	35	26	55	245	96
0020.229-00114	M24	200	46	32	70	385	150
0020.229-00115	M30	220	60	40	90	605	237
0020.229-00116	M36	250	74	47.5	110	826	323
0020.229-00117	M42	250	68	54	110	1002	392

① A_s: stress area of the threaded connector in mm².

② Design loads are for tension and are the maximum values for pure steel of the threaded connectors.

In addition the load capacity of the bar anchor embedded in concrete has to be checked for accordance with EN 1992-1-1, chapter 8.4 (NEN 6720 art. 9.6 and 9.16).

The required bonding strength depends strongly on the strength class of the concrete and has to be verified.

BAR ANCHORS

Spacer 1558 A4-80

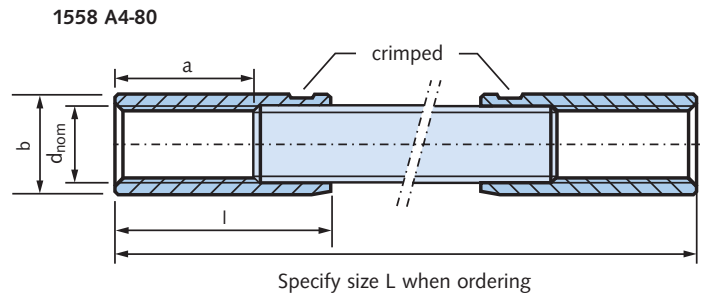

Anchor description

The bar anchor 1558 A4-80 consists of a threaded rod (untreated, quality 8.8) with screwed and crimped sleeves on both ends. The sleeves have metric ISO threads and are made of stainless steel (strength class A4-80).

This product is made on request; please specify required length when ordering.

Spacer 1558 A4-80

Order no.	Dimensions						Design loads ^②	
	d_{nom} [mm]	L min [mm]	a [mm]	b [mm]	l [mm]	A_s ^① [mm ²]	$N_{Rd,s}$ [kN] Steel	
0020.229-00121	M12	200	23	15.5	35	84	45	
0020.229-00122	M16	200	29	21	45	157	84	
0020.229-00123	M20	200	35	26	55	245	131	
0020.229-00124	M24	200	46	32	70	355	189	
0020.229-00125	M30	220	60	40	90	560	299	

① A_s : stress area of screwed in bolt/bar in mm².

② Design loads are for tension and are the maximum values for pure steel of the threaded bars.

In addition the load capacity of the bar anchor embedded in concrete has to be checked for accordance with EN 1992-1-1, chapter 8.4 (NEN 6720 art. 9.6 and 9.16).

The required bonding strength depends strongly on the strength class of the concrete and has to be verified.

BAR ANCHORS

Bending of bar anchors

Custom bending

1980-S

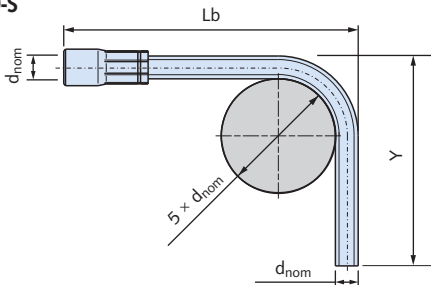

4010

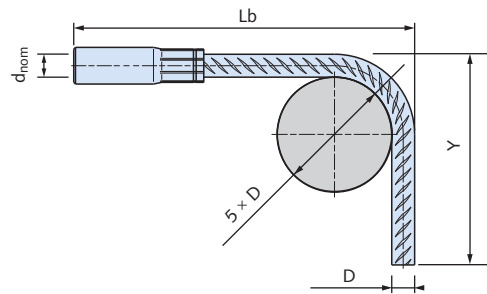

1980-S

Bending L	d _{nom} [mm]	Y min [mm]	Lb min [mm]	V ^① [mm]
max. 1250 mm	M12	200	145	33
max. 1250 mm	M16	200	165	45
max. 1250 mm	M20	200	195	55

① V = Change of length; L = Lb + Y - V

Note: Required bonding length has to be verified acc. to valid national standards

4010

D [mm]	d _{nom} [mm]	Y min [mm]	Lb min [mm]	V ^① [mm]
ø12	M16	200	140	33
ø16	M20	200	160	45
ø20	M24	200	210	55
ø25	M30	290	275	70
ø32	M42	330	325	90

① V = Change of length; L = Lb + Y - V

Note: Required bonding length has to be verified acc. to valid national standards

3010 - 3016

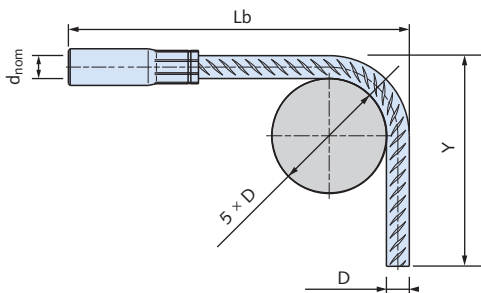

3010 - 3016

D [mm]	d _{nom} [mm]	Y min [mm]	Lb min [mm]	V ^① [mm]
ø12	M16	200	145	33
ø16	M20	200	185	45
ø20	M24	200	215	55
ø25	M30	290	280	70

① V = Change of length; L = Lb + Y - V

Note: Required bonding length has to be verified acc. to valid national standards

U-shaped bar anchors

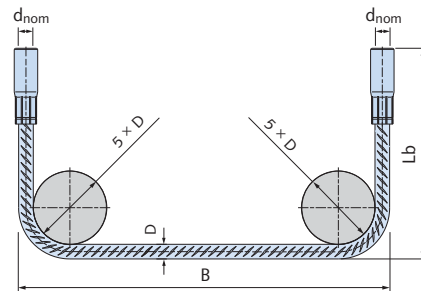

U-shaped

D [mm]	d _{nom} [mm]	B min [mm]	Lb min [mm]	2 * V ^① [mm]
ø12	M16	260	140	66
ø16	M20	330	160	90
ø20	M24	390	210	110
ø25	M30	510	275	140
ø32	M42	600	325	180

① V = Change of length; L = Lb + Y - V

Note: Required bonding length has to be verified acc. to valid national standards



- 1988-S 8.8 cannot be bent!
- Bent bar anchors are made to order

SOCKET ANCHORS

VEMO Socket Anchors

General information

The VEMO Socket anchors are light duty fixing anchors with low load capacities, mainly used for temporary fixings and applications without structural significance.

There is currently no calculation method to calculate the load capacity of the majority of the socket anchors.

For technical questions please contact our Technical Department,
→ contact information see inside back cover.

Material and corrosion protection

- Zinc galvanisation (GV)

These socket anchors are manufactured from a welded steel precision tube (cold sized) in accordance with EN 10305-3 (strength class E235). The surface is zinc galvanised, the internal thread is metric ISO.

- Stainless steel (A4)

The socket anchors in A4 material are manufactured from a welded stainless steel tube in accordance with EN 10217-7 (strength class A4-50). The internal thread is metric ISO.

VEMO - Socket anchors

995-GB GV

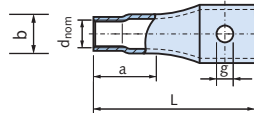

995-GB GV

Order no.	$d_{nom} \times L$ [mm]	a [mm]	g [mm]	b [mm]
0020.060-00035	M6 × 30	14	6.0	8.5
0020.060-00001	M6 × 40	20	6.0	8.5
0020.060-00002	M8 × 40	18	8.1	10.5
0020.060-00003	M8 × 50	25	8.1	10.5

995-G GV / A4

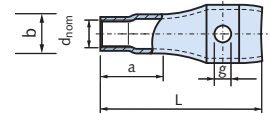

995-G GV

Order no.	$d_{nom} \times L$ [mm]	a [mm]	g [mm]	b [mm]
0020.060-00004	M10 × 50	20	6.2	13.5
0020.060-00005	M12 × 60	23	7.2	17.0
0020.060-00006	M12 × 70	30	7.2	17.0
0020.060-00007	M16 × 70	25	9.2	21.3
0020.060-00008	M16 × 80	25	12.2	21.3
0020.060-00009	M16 × 100	32	9.2	21.3
0020.060-00010	M16 × 120	45	12.2	21.3
0020.060-00011	M20 × 100	40	12.2	26.9
0020.060-00012	M20 × 120	40	14.2	26.9
0020.060-00013	M24 × 120	50	14.2	33.7
0020.060-00014	M30 × 150	70	15.2	42.0

995 A4

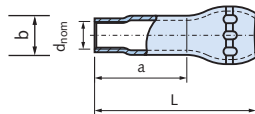

995 A4

Order no.	$d_{nom} \times L$ [mm]	a [mm]	b [mm]
0020.100-00009	M6 × 40	25	8.5

995-G A4

Order no.	$d_{nom} \times L$ [mm]	a [mm]	g [mm]	b [mm]
0020.060-00015	M8 × 50	20	7.0	10.5
0020.060-00016	M10 × 50	20	6.2	13.5
0020.060-00017	M12 × 60	25	9.2	17.0
0020.060-00018	M16 × 80	25	12.2	21.3
0020.060-00019	M16 × 100	25	12.2	21.3
0020.060-00020	M20 × 100	40	14.2	26.9
0020.060-00021	M24 × 120	50	14.2	33.7

SOCKET ANCHORS

VEMO Socket Anchors

995-DG GV

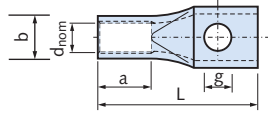

995-DG GV				
Order no.	$d_{nom} \times L$ [mm]	a [mm]	g [mm]	b [mm]
0020.030-00001	M12 × 60	22	10	16.0
0020.030-00002	M16 × 75	22	13	21.5
0020.030-00007	M16 × 100	35	13	21.5
0020.030-00003	M20 × 90	25	15	27.0
0020.030-00008	M20 × 120	45	15	27.0
0020.030-00004	M24 × 100	30	17	32.0
0020.030-00005	M30 × 135	35	22	40.0

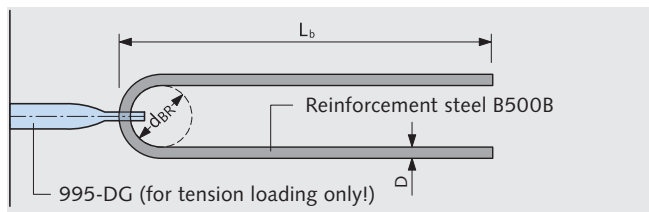

Additional reinforcement (not in scope of delivery)

1036-G GV / A4

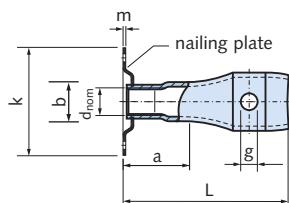

1036-G GV						
Order no.	$d_{nom} \times L$ [mm]	a [mm]	g [mm]	b [mm]	k [mm]	m [mm]
0020.070-00001	M10 × 50	20	6.2	13.5	34	1
0020.070-00002	M12 × 70	30	7.2	17.0	40	1
0020.070-00003	M16 × 80	25	12.2	21.3	44	1.5
0020.070-00004	M16 × 100	32	9.2	21.3	44	1.5
0020.070-00005	M20 × 100	40	12.2	26.9	48	1.5
0020.070-00006	M24 × 120	50	14.2	33.7	57	1.5

1036-G A4						
Order no.	$d_{nom} \times L$ [mm]	a [mm]	g [mm]	b [mm]	k [mm]	m [mm]
0020.070-00008*	M10 × 50	20	6.2	13.5	34	1
0020.070-00009	M12 × 60	25	9.2	17.0	40	1
0020.070-00007	M16 × 80	25	12.2	21.3	48	1.5
0020.070-00010	M20 × 100	40	14.2	26.9	48	1.5

* including sealing cap type 2244 (see page 35)

1130 GV

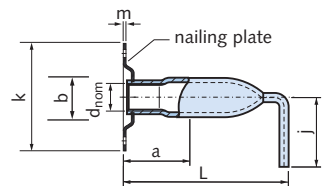

1130 GV						
Order no.	$d_{nom} \times L$ [mm]	a [mm]	j [mm]	b [mm]	k [mm]	m [mm]
0020.050-00001	M10 × 60	35	25	13.5	34	1
0020.050-00002	M12 × 70	40	30	17.0	40	1
0020.050-00003	M16 × 100	32	35	21.3	44	1.5
0020.050-00004	M20 × 100	40	35	26.9	48	1.5

1140 GV / A4

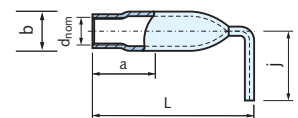

1140 GV				
Order no.	$d_{nom} \times L$ [mm]	a [mm]	j [mm]	b [mm]
0020.040-00001	M8 × 50	30	20	10.5
0020.040-00002	M10 × 60	35	25	13.5
0020.040-00003	M12 × 45	18	25	17.0
0020.040-00004	M12 × 70	40	30	17.0
0020.040-00005	M16 × 60	24	30	21.3
0020.040-00006	M16 × 100	32	35	21.3
0020.040-00007	M20 × 70	30	30	26.9
0020.040-00008	M20 × 100	40	35	26.9
0020.040-00009	M24 × 80	24	35	33.7

1140 A4				
Order no.	$d_{nom} \times L$ [mm]	a [mm]	j [mm]	b [mm]
0020.040-00010	M8 × 50	30	20	10.5
0020.040-00011	M10 × 60	35	25	13.5
0020.040-00012	M12 × 70	40	30	17.0
0020.040-00013	M16 × 100	32	35	21.3

ACCESSORIES

DEMU Accessories

Accessories

HALFEN/DEMU provide numerous accessories which facilitate the installation of all anchoring systems. Further information about assembly see page 36.

2250

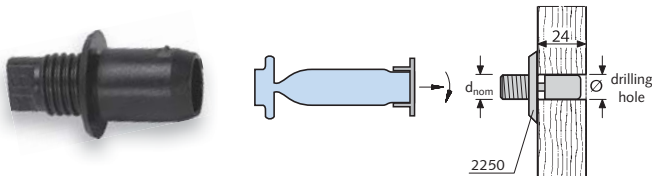

Fixing pin

- ▶ Hammer fixing pin into hole in formwork
- ▶ Screw on anchor
- ▶ Pour the concrete
- ▶ After the concrete has cured remove the formwork
- ▶ Unscrew and remove pin to continue installation

2250			
Order no.	d_{nom} [mm]	Drilling [mm]	Colour
0021.020-00001	M6	$\varnothing 11 \times 23$	green
0021.020-00002	M8	$\varnothing 11 \times 23$	blue
0021.020-00003	M10	$\varnothing 11 \times 23$	yellow
0021.020-00004	M12	$\varnothing 11 \times 23$	red
0021.020-00005	M16	$\varnothing 17 \times 24$	black
0021.020-00006	M20	$\varnothing 17 \times 24$	white
0021.020-00007	M24	$\varnothing 17 \times 24$	blue

2282

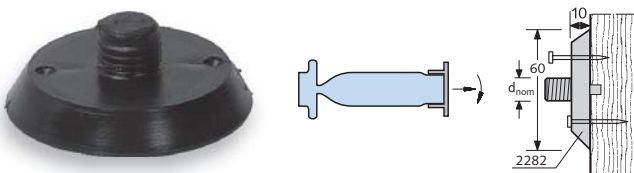

Nailing plate $h = 10$ mm, with nail holes and fixing pin

2282				
Order no.	d_{nom} [mm]	h [mm]	\varnothing [mm]	Colour
0021.120-00001	M16	10	60	black
0021.120-00002	M20	10	60	yellow

2280

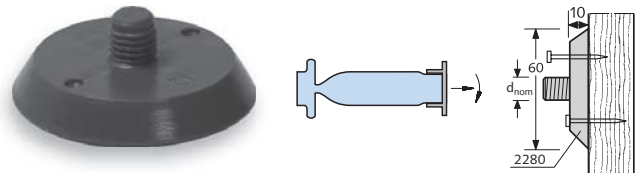

Nailing plate $h = 10$ mm, with nail holes

2280				
Order no.	d_{nom} [mm]	h [mm]	\varnothing [mm]	Colour
0021.010-00001	M8	10	60	blue
0021.010-00002	M10	10	60	yellow
0021.010-00003	M12	10	60	red
0021.010-00004	M16	10	60	black
0021.010-00005	M20	10	60	yellow
0021.010-00006	M24	10	60	blue
0021.010-00007	M30	7	60	grey

2275

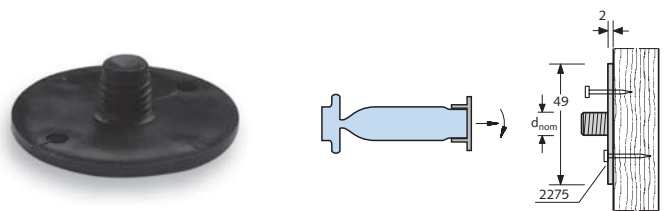

Nailing plate $h = 2$ mm, with nail holes

2275				
Order no.	d_{nom} [mm]	h [mm]	\varnothing [mm]	Colour
0021.090-00001	M10	2	49	white
0021.090-00002	M12	2	49	black
0021.090-00003	M16	2	49	green
0021.090-00004	M20	2	49	red
0021.090-00005	M24	2	49	yellow

ACCESSORIES

DEMU Accessories

2600

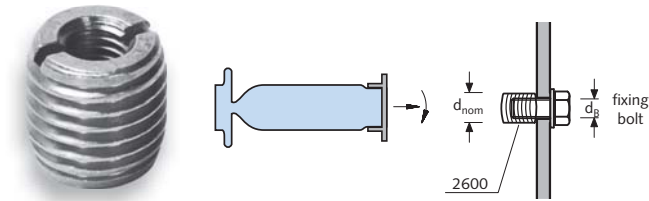

Thread adapter

Reduces diameter of holes in formwork.
Zinc galvanised and reusable.

2600		
Order no.	d_{nom} [mm]	d_B [mm]
0021.060-00001	M12	M6
0021.060-00002	M16	M8
0021.060-00003	M20	M8
0021.060-00004	M24	M10
0021.060-00005	M30	M10
0021.060-00006	M36	M10
0021.060-00007	M42	M12

d_B = Diameter of fixing bolt
length of thread adapter $l = 16$ mm

2244

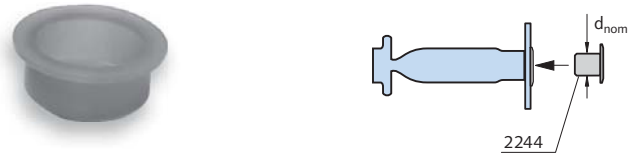

Sealing cap

Protects against ingress of dirt and water.

2244			
Order no.	d_{nom} [mm]	Size [mm]	Colour
0021.030-00001	M6	5.5	red
0021.030-00002	M8	7.0	red
0021.030-00003	M10	9.0	red
0021.030-00004	M12	11.0	red
0021.030-00005	M16	14.5	black
0021.030-00006	M20	18.0	blue
0021.030-00007	M24	21.5	red
0021.030-00008	M30	27.0	white
0021.030-00009	M36	33.5	white
0021.030-00010	M42	38.4	white

2290

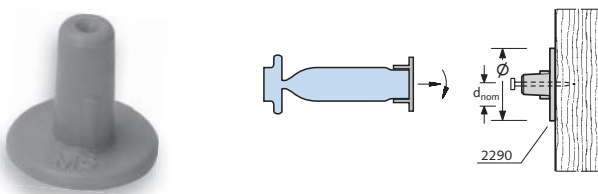

Nailing plug (excluding nail)

for easy assembly of socket anchors

2290		
Order no.	d_{nom} [mm]	ϕ [mm]
0021.050-00001	M8	18
0021.050-00002	M10	22
0021.050-00003	M12	25
0021.050-00004	M16	31
0021.050-00005	M20	37

INSTALLATION INSTRUCTIONS

Fixing Anchors

Assembly steps

Fixing to the formwork

Preparing for assembly

Screw-in and fixing of the bolt ①

Case A
with
plastic nailing plate

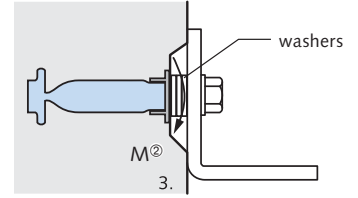
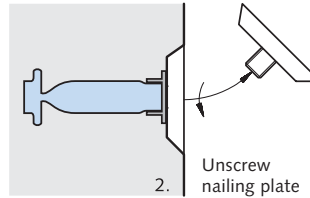
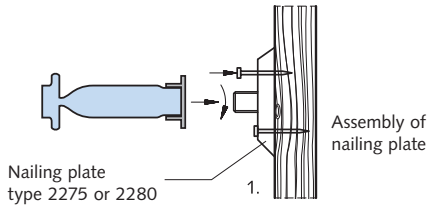

Case B
with
plastic fixing pin

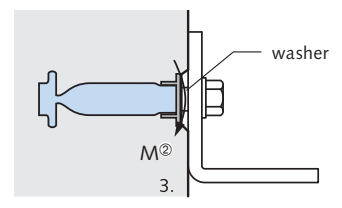
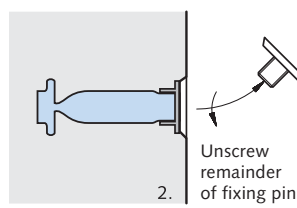
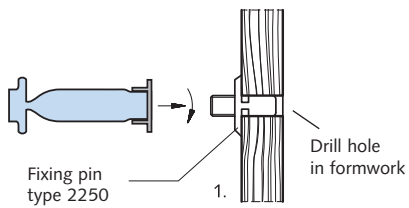

Case C
Fixing anchors
with
nailing plate

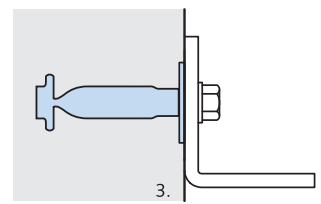
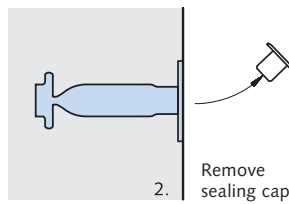
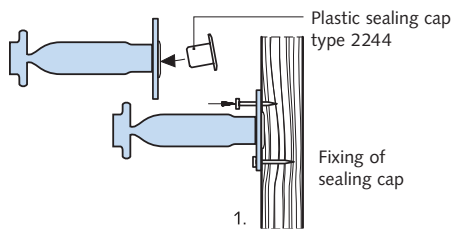

Case D
with hexagonal bolt

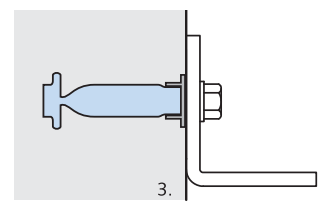
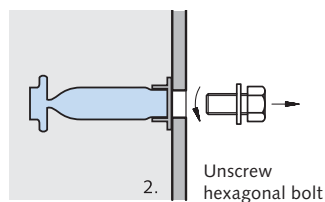
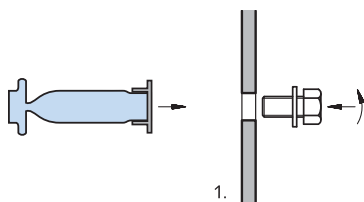

Case E
with thread adapter
and hexagonal bolt

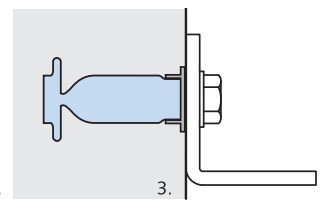
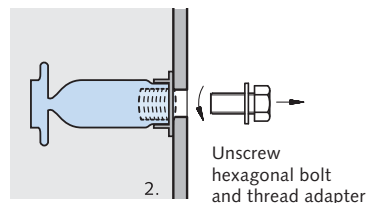
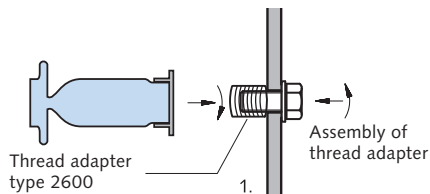

Case F
with magnetic
fixing plate on
steel formwork

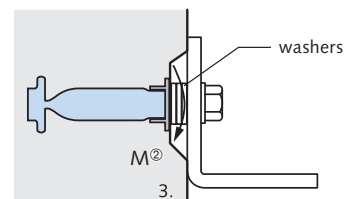
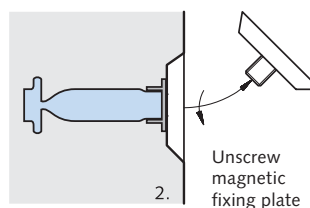
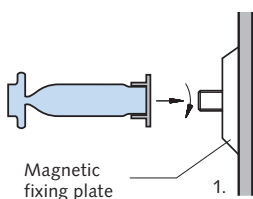

① Torque T_{inst} → see table on page 37

② Bending of bolt has to be verified by customer! (Bolt is not included in scope of delivery)

INSTALLATION INSTRUCTIONS

Fixing Anchors and Accessories

Installation parameters

General notes on installation

Before installing the fixing components, check whether the inside of the sockets and sleeves are dry and free from any contamination. In order to guarantee best possible bond between the fixing anchor and the concrete, make sure that the surface of the anchor is free from dirt, oil, etc. The concrete has to be poured carefully; please avoid direct contact between the compacting device and the fixing anchor.

The fixing anchors may be embedded flush or recessed in the concrete. It is strongly recommended to use washers to shim if anchors are recessed. After striking the formwork, the inside of the threaded socket must be further protected against ingress of water, dirt or oil until required for use i.e. for fixing components. Ensure the inside of the socket remains dry after final assembly.

The fixing component (bolt with standard metric thread) has to be selected according to the static engineer's specifications. Minimum screw-in length (s) for bolts and maximum installation torque (T_{inst}) can be found in the adjacent tables.

The fixing anchor must not be subjected to full load capacity until the concrete has reached its final strength.

The complete assembly instruction for DEMU fixing anchors in various languages can be found at www.halfen.de



T-FIXX®		
Thread-size	Minimum screw-in length s [mm]	Torque T_{inst} [Nm]
M10	17.0	≤ 8
M12	20.0	≤ 10
M16	26.0	≤ 30
M20	32.0	≤ 60

Bolt anchor 1988		
Thread-size	Minimum screw-in length s [mm]	Torque T_{inst} [Nm]
M12	16.4	≤ 10
M16	21.2	≤ 30
M20	26.0	≤ 50
M24	30.8	≤ 90
M30	38.0	≤ 180
M36	45.2	≤ 250
M42	52.4	≤ 300

Bolt anchor 1985		
Thread-size	Minimum screw-in length s ^① [mm]	Torque T_{inst} [Nm]
M12	18.0	≤ 10
M16	24.0	≤ 30
M20	30.0	≤ 50
M24	36.0	≤ 90

① value $s = 1.5 \times d_{nom}$

Bolt anchor 1980-P / Bar anchor		
Thread-size	Minimum screw-in length s ^② [mm]	Torque T_{inst} [Nm]
M12	14.4	≤ 10
M16	19.2	≤ 30
M20	24.0	≤ 50
M24	28.8	≤ 90
M30	36.0	≤ 180
M36	43.2	≤ 250
M42	50.4	≤ 300

② value $s = 1.2 \times d_{nom}$; for bar anchors type 3016 (secured to the formwork with integrated nailing plates), the values have to be increased by 25% → ($s = 1.5 \times d_{nom}$)

Socket anchors		
Thread-size	Minimum screw-in length s ^③ [mm]	Torque T_{inst} [Nm]
M6	7.2	≤ 1
M8	9.6	≤ 2
M10	12.0	≤ 4
M12	14.4	≤ 8
M16	19.2	≤ 17
M20	24.0	≤ 25
M24	28.8	≤ 53
M30	36.0	≤ 96

③ value $s = 1.2 \times d_{nom}$; for socket anchors type 1130, 1130-G (secured to the formwork with integrated nailing plates), the values have to be increased by 25% → ($s = 1.5 \times d_{nom}$)

FIXING COMPONENTS – ASSEMBLY INSTRUCTION

Determining Bolt Length

General

The fixture is attached to the cast-in anchor with a standard metric thread fastening bolt and washer or a threaded rod, a washer and a nut.

The fixing components are not included with the DEMU Fixing systems and have to be ordered separately. The fixing component (bolt) has to be selected according to the static engineer's specifications.

Screw-in length of bolt

For all fixing anchors there is a minimum and a maximum screw-in length. Minimum values can be found in chapter "Installation instructions", page 37. The corresponding maximum values for each type can be found in the tables of the respective chapters (pages 12 – 33). To find the required bolt length, proceed as described below.

Determining of bolt length

Determining the required bolt length (Ls)

Bolt length (Ls)

$Ls, \min = s + k$ (minimum bolt length)

$Ls, \max = a + k$ (maximum bolt length)

k = clamp thickness

(thickness of the steel angle support and the washers)

s = minimum screw-in length (→ see tables on page 37)

a = maximum screw-in length (→ see tables on pages 12 – 33)

Example for determining bolt length

Recessed T-FIXX M12×70

secured to the framework with

a plastic nailing plate (type 2275)

$Ls, \min = 1.5 \times d_{\text{nom}} + k = 18 + 17 = 35$

$Ls, \max = a + k = 36 + 17 = 53$

→ bolt M12×40

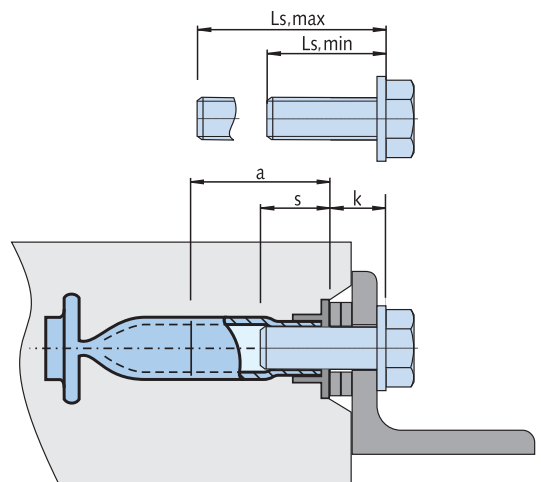

Fixing T-FIXX M12×70 to formwork with plastic nailing plate

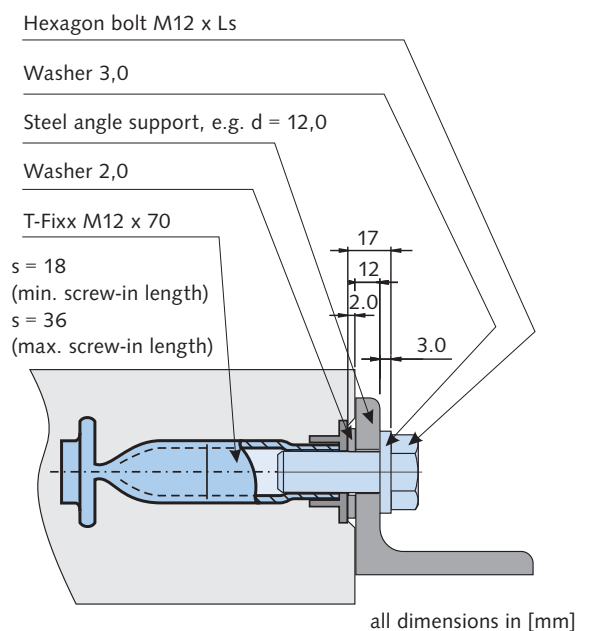
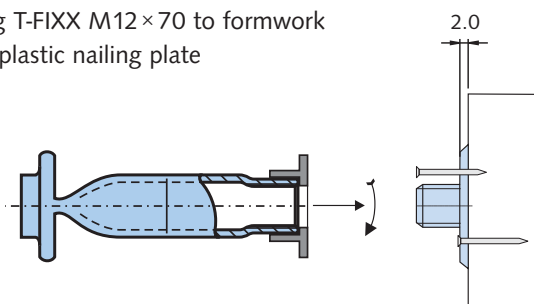

SOFTWARE

Calculation Basics

General

The following information is required to verify a fixing anchor:

- type and material of DEMU Fixing anchor
- size of DEMU Fixing anchor (M-thread and length)
- number of fasteners (single anchor or group up to six anchors)
- position of the DEMU Fixing anchors in the concrete, located by its distance from the lower, the upper, the left and right edges of the component
- thickness of the concrete component
- concrete strength class
- condition of the concrete: cracked or verified as non-cracked
- presence of (dense) reinforcement in the vicinity of the fixing anchor (yes/no)
- tensile load, shear load and bending moment

Technical support

We can provide additional engineering services and technical support for your individual projects. Contact information can be found on the inside back cover.

Verification method

Tension loading

- ▶ verify steel failure of fastener
- ▶ verify pull-out failure
- ▶ verify concrete cone failure
- ▶ verify splitting failure
- ▶ verify blow-out failure

Shear loading

- ▶ verify steel failure of fastener (with or without lever arm)
- ▶ verify concrete pry-out failure
- ▶ verify concrete edge failure

Verify combination of tension and shear loading

Software download



Note:

A simple to use software to simplify calculation can be downloaded free at:

www.halfen.de

www.demu.com

www.t-fixx.com



The fixing components (fastening bolts, washers, etc.) are not included with the DEMU Fixing system. These components must be ordered separately for each project according to the static engineer's specifications.

SOFTWARE

Calculation Software

DEMU Software for fixing anchors

The DEMU Calculation program for DEMU T-FIXX® and DEMU Bolt anchors (types 1988, 1985, 1980-P) provides the user with a convenient and powerful calculation tool.

Basis for the calculation of DEMU Fixing anchors is the European standard CEN/TS 1992-4-1/2 (May 2009) which also covers the design method for headed fasteners.

This pre-norm prescribes a wider range of verifications which are processed by user-friendly DEMU software. The result for the relevant load situation requires minimal input by the user.



The software can be found under:
www.halfen.de → service → software/CAD
It is also provided under www.demu.com
and www.t-fixx.com.

Boundary conditions

The calculation takes into account all necessary boundary conditions, for example:

- concrete strength
- cracked or non-cracked concrete
- the concrete components geometry, in particular the distances of the fixing anchors to the component edge
- geometry / size of the fixing base plate
- various reinforcement patterns
- consideration of several dimensioning loads
- configuration of fasteners, e.g. single fastener or group of fasteners (up to 6 fasteners)

Bolts

The required bolts are not considered; the customer has to order and calculate for choice of bolts.

Input

The geometry and loads are entered interactively. Entries are displayed in a graphic.

The anchor geometry can also be modified in a dedicated "drawing" tab.

Calculation

The calculation is according to the European standard CEN/TS 1992-4-1/2.

Results

The software calculates and displays either the results for a preselected anchor or – in automatic selection – a list of all suitable anchors. Results highlighted in red indicate excessive loads or incomplete verifications.

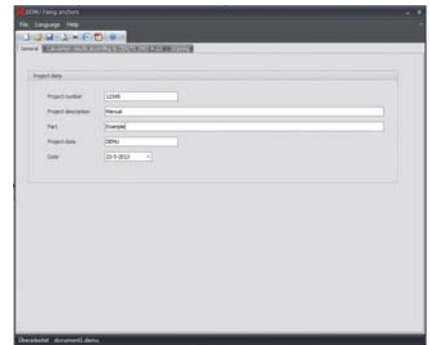

Screenshot 1: "general" tab with project data

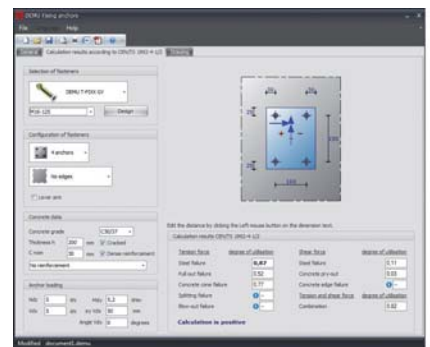

Screenshot 2: "calculation" tab

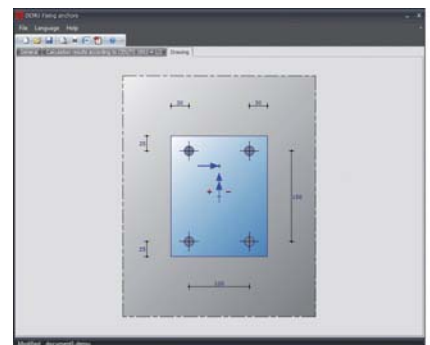

Screenshot 3: "drawing" tab



Screenshot 4: "preview" tab with calculation report

SOFTWARE

Calculation Software / Tender Text

DEMU Software for fixing anchors

Visual control



All verifications for the selected anchor are listed in the "calculation" tab. Values highlighted in red indicate an excessive load, which means values higher than 1.0 in the unity check.

Detailed information on all calculation results are displayed in the "preview" tab.

Printouts



Printouts are possible in a brief and verifiable long version. The short version shows only an overview of boundary conditions and calculation results of the different failure mechanisms.

The long version includes all decisive verifications for a verifiable printout. Both versions can also be exported as a MS-Word-file or as a pdf-file.

Software version



The latest version of the dimensioning program is available for download on the internet at www.halfen.de
www.demu.com
www.t-fixx.com.
Including the option to select English, German, French or Dutch as language.

System requirements:

- Windows XP, Vista, Windows 7 with up-to-date Servicepacks
- installed .NET Framework 3.5 SP1
- 1 GB RAM / 1.800 MHz
- Screen resolution: 1024 x 768 px

Tender text

DEMU Fixing anchor type T-FIXX M16x100 GV

DEMU Fixing anchor T-FIXX® with standard metric ISO thread for permanent fixing of components,

with European Technical Approval ETA-13/0222, suitable for anchoring in reinforced or non-reinforced standard concrete in strength class of at least C20/25 and maximum C50/60 in accordance with EN 206:2000-12, statics proven in accordance with CEN/TS 1992-4 section 1 and 2,

Type T-FIXX M16x100 GV

with

M16 = Standard metric ISO thread size M16 [mm],

100 = Total length of fixing anchor [mm] (plus data clip length),

GV = Corrosion protection zinc galvanised,

or equivalent, deliver and install according to the manufacturer's instructions.



SOFTWARE

Calculation Example

Example for design of T-FIXX® using DEMU Calculation software

Given data

- corrosion resistance: Zinc galvanised
- concrete strength: C30/37
- slab thickness: $h = 200 \text{ mm}$
- concrete cover: $c_{nom} = 30 \text{ mm}$
- design loads: $N_{dz} = 5 \text{ kN}$
 $V_{dx} = 5 \text{ kN}$
 $M_{dy} = 5.2 \text{ kNm}$
 $e_y = 50 \text{ mm}$
 (excentricity of shear load)
- group of four fasteners
- no influence of edges



Calculation for a selected T-FIXX M12 × 95

Tension force	degree of utilisation	Shear force	degree of utilisation
Steel failure	1,38	Steel failure	0,18
Pull-out failure	0,83	Concrete pry-out	0,04
Concrete cone failure	1,12	Concrete edge failure	1 --
Splitting failure	1 --	Tension and shear force	degree of utilisation
Blow-out failure	1 --	Combination	1,30

Calculation is negative

Calculation is negative!

Loads are too high for 4 × T-FIXX M12 × 95



Solution: Change diameter from M12 to M16 and recalculate

Tension force	degree of utilisation	Shear force	degree of utilisation
Steel failure	0,87	Steel failure	0,11
Pull-out failure	0,52	Concrete pry-out	0,03
Concrete cone failure	0,77	Concrete edge failure	1 --
Splitting failure	1 --	Tension and shear force	degree of utilisation
Blow-out failure	1 --	Combination	0,82

Calculation is positive

Calculation is positive with 4 × T-FIXX M16 × 125



CONTACT HALFEN WORLDWIDE

HALFEN is represented by subsidiaries in the following 14 countries, please contact us:

Austria	HALFEN Gesellschaft m.b.H. Leonard-Bernstein-Str. 10 1220 Wien	Phone: +43-1-2596770 E-Mail: office@halfen.at Internet: www.halfen.at	Fax: +43-1-259-677099
Belgium/ Luxembourg	HALFEN N.V. Borkelstraat 131 2900 Schoten	Phone: +32-3-6580720 E-Mail: info@halfen.be Internet: www.halfen.be	Fax: +32-3-6581533
China	HALFEN Construction Accessories Distribution Co.Ltd. Room 601 Tower D, Vantone Centre No. A6 Chao Yang Men Wai Street Chaoyang District Beijing · P.R. China 100020	Phone: +86-1059073200 E-Mail: info@halfen.cn Internet: www.halfen.cn	Fax: +86-1059073218
Czech Republic	HALFEN s.r.o. Business Center Šafránkova Šafránkova 1238/1 155 00 Praha 5	Phone: +420-311-690060 E-Mail: info@halfen-deha.cz Internet: www.halfen-deha.cz	Fax: +420-235-314308
France	HALFEN S.A.S. 18, rue Goubet 75019 Paris	Phone: +33-1-44523100 E-Mail: halfen@halfen.fr Internet: www.halfen.fr	Fax: +33-1-44523152
Germany	HALFEN Vertriebsgesellschaft mbH Katzbergstrasse 3 40764 Langenfeld	Phone: +49-2173-970-0 E-Mail: info@halfen.de Internet: www.halfen.de	Fax: +49-2173-970225
Italy	HALFEN S.r.l. Soc. Unipersonale Via F.lli Bronzetti N° 28 24124 Bergamo	Phone: +39-035-0760711 E-Mail: info@halfen.it Internet: www.halfen.it	Fax: +39-035-0760799
Netherlands	HALFEN b.v. Oostermaat 3 7623 CS Borne	Phone: +31-74-267 14 49 E-Mail: info@halfen.nl Internet: www.halfen.nl	Fax: +31-74-267 2659
Norway	HALFEN AS Postboks 2080 4095 Stavanger	Phone: +47-51 82 34 00 E-Mail: post@halfen.no Internet: www.halfen.no	Fax: +47-51 82 34 01
Poland	HALFEN Sp. z o.o. Ul. Obornicka 287 60-691 Poznan	Phone: +48-61-622 14 14 E-Mail: info@halfen.pl Internet: www.halfen.pl	Fax: +48-61-622 14 15
Sweden	Halfen AB Vädursgatan 5 412 50 Göteborg	Phone: +46-31-98 58 00 E-Mail: info@halfen.se Internet: www.halfen.se	Fax: +46-31-98 58 01
Switzerland	HALFEN Swiss AG Hertistrasse 25 8304 Wallisellen	Phone: +41-44-849 78 78 E-Mail: mail@halfen.ch Internet: www.halfen.ch	Fax: +41-44-849 78 79
United Kingdom/ Ireland	HALFEN Ltd. A1/A2 Portland Close Houghton Regis LU5 5AW	Phone: +44-1582-47 03 00 E-Mail: info@halfen.co.uk Internet: www.halfen.co.uk	Fax: +44-1582-47 03 04
United States of America	HALFEN USA Inc. 8521 FM 1976 P.O. Box 547 Converse, TX 78109	Phone: +1 800.423.91 40 E-Mail: info@halfenusa.com Internet: www.halfenusa.com	Fax: +1 877.683.4910
For countries not listed HALFEN International	HALFEN International GmbH Liebigstr. 14 40764 Langenfeld /Germany	Phone: +49-2173-970-0 E-Mail: info@halfen.com Internet: www.halfen.com	Fax: +49-2173-970-849

Furthermore HALFEN is represented with sales offices and distributors worldwide. Please contact us: www.halfen.com

NOTES REGARDING THIS CATALOGUE

Technical and design changes reserved. The information in this publication is based on state-of-the-art technology at the time of publication. We reserve the right to make technical and design changes at any time. HALFEN GmbH shall not accept liability for the accuracy of the information in this publication or for any printing errors.

The Quality Management System of Halfen GmbH is certified for the locations in Germany, France, the Netherlands, Austria, Poland, Switzerland and the Czech Republic according to **DIN EN ISO 9001:2008**, Certificate No. QS-281 HH.





For further information please contact: www.halfen.com