

PULL HANDLES



PULL HANDLES

WELCOME TO PROJECTS 360 PULL HANDLE RANGE.

At Häfele, we supply high-quality pull handles suitable for both residential and commercial settings, covering a wide variety of applications.

This product guide is designed to provide you with the latest technical specs of our main pull handle products. We also offer bespoke solutions if you can't find what you need.

PROJECTS 360°

"D" SHAPE PULL HANDLE 316 GRADE STAINLESS STEEL PROJECTS CODE: HUKP-0101-55

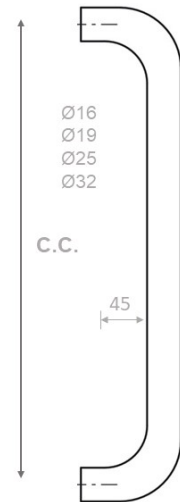

PRODUCT FEATURES

- > Pull handle "D" Shape design section
- > Hole centres standard at: 300, 425, 650, 900 and 1000mm
- > Diameters available: 16mm, 19mm, 25mm and 32mm
- > Fixing types: Bolt through, Back to Back or Secret fixing
- > To suit doors up to 60mm thick and glass doors 8-12mm

QUALITY MARKS

- > Manufactured in grade 316 stainless steel

PERFORMANCE GUARANTEE

- > 25 Years

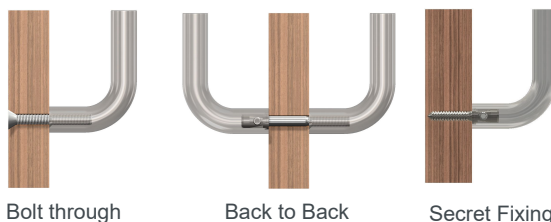

FINISHES

- > Satin Stainless Steel finish shown



* Other finishes available to special order

Contact us for help and advice on your next project.

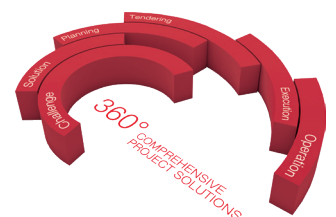

PROJECTS 360°

CRANKED PULL HANDLE 316 GRADE STAINLESS STEEL PROJECTS CODE: HUKP-0101-61

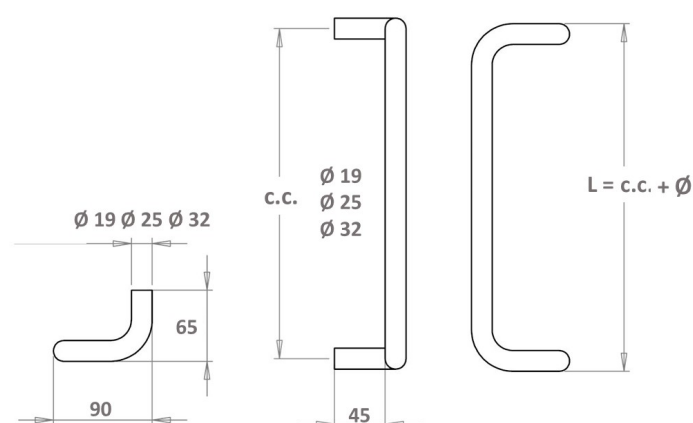

PRODUCT FEATURES

- > Pull handle Cranked design section
- > Hole centres standard at: 300, 425, 650, 900 and 1000mm
- > Diameters available: 19mm, 25mm and 32mm
- > Fixing types: Bolt Through, Back to Back or Secret fixing
- > To suit doors up to 60mm thick and glass doors 8-12mm

QUALITY MARKS

- > Manufactured in grade 316 stainless steel

PERFORMANCE GUARANTEE

- > 25 Years



FINISHES

- > Satin Stainless Steel finish shown



* Other finishes available to special order

Contact us for help and advice on your next project.

0800 171 2907

estimating@hafele.co.uk

hafele.co.uk

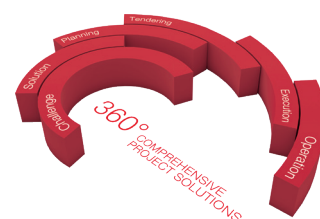

PROJECTS 360°

GUARDSMAN PULL HANDLE 316 STAINLESS STEEL ON PILLARS PROJECTS CODE: HUKP-0101-43

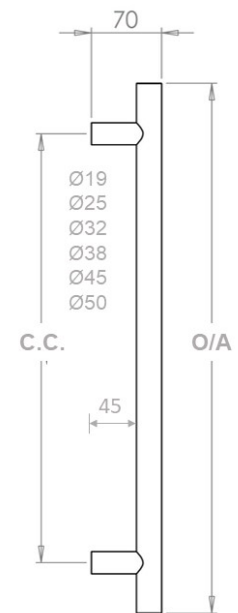

PRODUCT FEATURES

- > Pull handle Guardsman design section on pillars
- > Hole centres standard at: 300, 425, 600, 900 and 1000mm
- > For overall length please add 100mm to hole centres dimension
- > Diameters available: 19, 25, 32, 38, 45 and 50mm
- > Fixing types: Bolt through, Back to Back or Secret fixing
- > To suit doors up to 60mm thick and glass doors 8-12mm

QUALITY MARKS

- > Manufactured in grade 316 stainless steel

PERFORMANCE GUARANTEE

- > 25 Years



FINISHES

- > Satin Stainless Steel finish shown



* Other finishes available to special order

Contact us for help and advice on your next project.

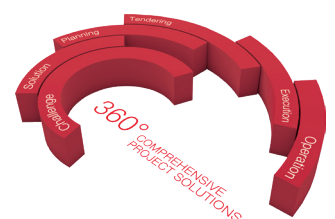

PROJECTS 360°

MITRED PULL HANDLE 316 STAINLESS STEEL PROJECTS CODE: HUKP-0101-56

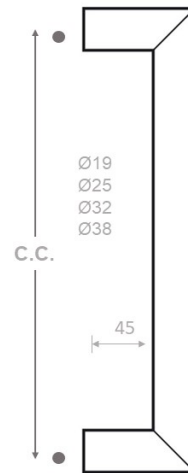

PRODUCT FEATURES

- > Pull handle Mitred shape section
- > Hole centres standard at: 300, 425, 650, 900, 1000 and 1200mm
- > Diameters available: 19, 25, 32 and 38mm
- > Fixing types: Bolt through, Back to Back or Secret fixing
- > To suit doors up to 60mm thick and glass doors 8-12mm

QUALITY MARKS

- > Manufactured in grade 316 stainless steel

PERFORMANCE GUARANTEE

- > 25 Years



FINISHES

- > Satin Stainless Steel finish shown



* Other finishes available to special order

Contact us for help and advice on your next project.

0800 171 2907 estimating@hafele.co.uk hafele.co.uk

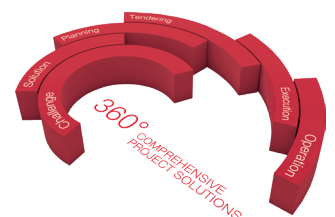

PROJECTS 360°

HALF RADIUS PULL HANDLE

316 STAINLESS STEEL ON PILLARS

PROJECTS CODE: **HUK-0101-12**

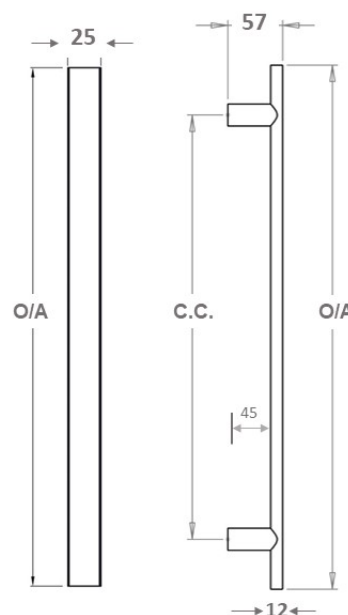
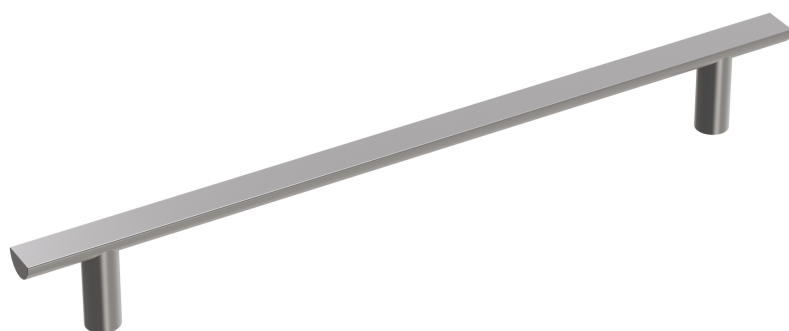

PRODUCT FEATURES

- > Pull handle "Half Moon" design section on pillars
- > Hole centres standard at: 300, 425, 600, 900 and 1000mm
- > For overall length, please add 100mm to hole centres dimension
- > Fixing types: Bolt through, Back to Back or Secret fixing
- > To suit doors up to 60mm thick and glass doors 8-12mm

QUALITY MARKS

- > Manufactured in grade 316 stainless steel

PERFORMANCE GUARANTEE

- > 25 Years

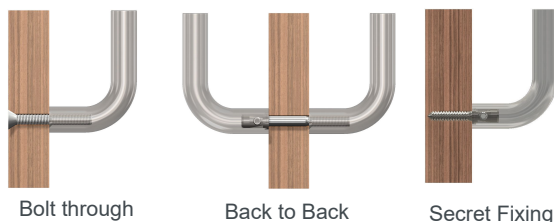

Contact us for help and advice on your next project.

0800 171 2907

estimating@hafele.co.uk

hafele.co.uk

FINISHES

- > Satin Stainless Steel finish shown



* Other finishes available to special order



PROJECTS 360°

FLAT PULL HANDLE 316 STAINLESS STEEL PROJECTS CODE: HUKP-0101-14

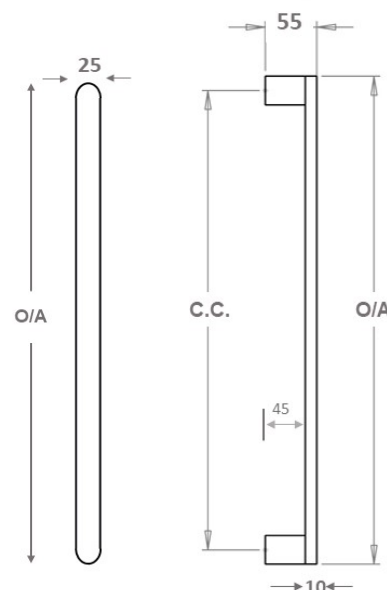
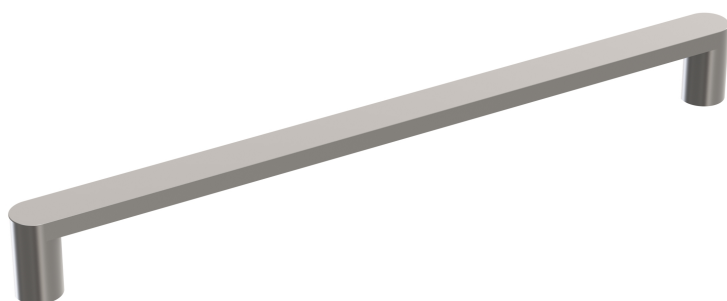

PRODUCT FEATURES

- > Pull handle Flat design solid section
- > Hole centres standard at: 300, 425, 600, 900 and 1000mm
- > Fixing types: Bolt through, Back to Back or Secret fixing
- > To suit doors up to 60mm thick and glass doors 8-12mm

QUALITY MARKS

- > Manufactured in grade 316 stainless steel

PERFORMANCE GUARANTEE

- > 25 Years



Bolt through

Back to Back

Secret Fixing

FINISHES

- > Satin Stainless Steel finish shown



* Other finishes available to special order

Contact us for help and advice on your next project.

0800 171 2907

estimating@hafele.co.uk

hafele.co.uk



PROJECTS 360°

TAPERED PULL HANDLE 316 SOLID STAINLESS STEEL PROJECT CODE: HUKP-0101-18

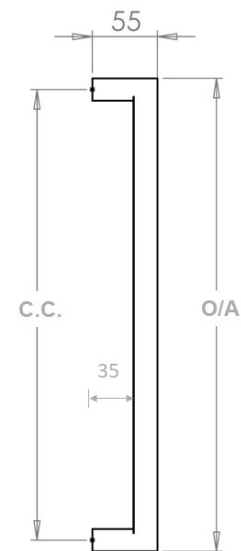
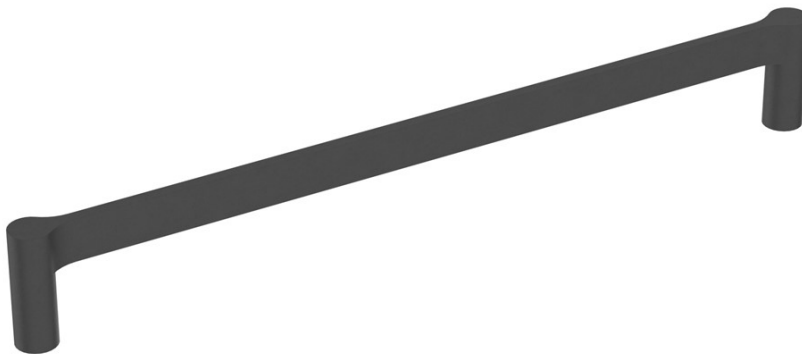

PRODUCT FEATURES

- > Pull handle tapered design section
- > Hole centres standard at: 300, 425, 600, 900 and 1000mm
- > Fixing types: Bolt through, Back to Back or Secret fixing
- > To suit doors up to 60mm thick and glass doors 8-12mm

QUALITY MARKS

- > Manufactured in grade 316 stainless steel

PERFORMANCE GUARANTEE

- > 25 Years

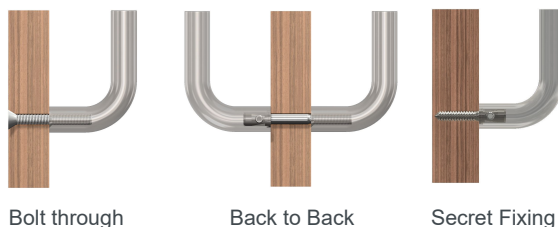

Bolt through

Back to Back

Secret Fixing

FINISHES

- > Matt Black finish shown



Matt Black



Satin Stainless Steel



Polished Stainless Steel



Mid Bronze*



Dark Bronze*



Häfele Black



Polished Brass



Satin Brass



RAL Colour*

* Other finishes available to special order

Contact us for help and advice on your next project.

0800 171 2907

estimating@hafele.co.uk

hafele.co.uk

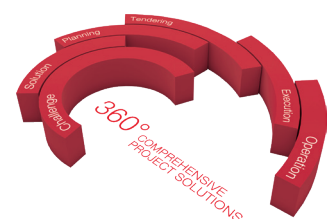

PROJECTS 360°

KNURLED PULL HANDLE 316 STAINLESS STEEL ON PILLARS PROJECT CODE: HUKP-0101-52

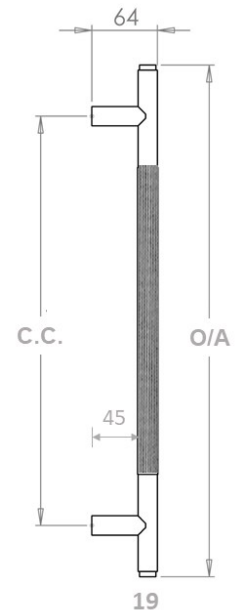
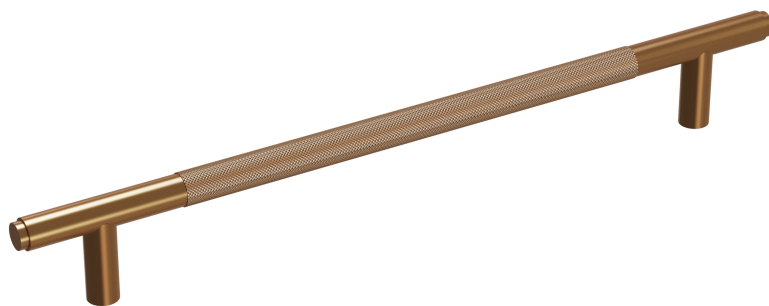

PRODUCT FEATURES

- > Pull handle knurled design solid section on pillars
- > Hole centres standard at: 300, 425, 600, 900 and 1000mm
- > For overall length, please add 100mm to hole centres dimension
- > Fixing types: Bolt through, Back to Back or Secret fixing
- > To suit doors up to 60mm thick and glass doors 8-12mm

QUALITY MARKS

- > Manufactured in grade 316 stainless steel with knurled mid- section

PERFORMANCE GUARANTEE

- > 25 Years



Bolt through

Back to Back

Secret Fixing

FINISHES

- > Light Bronze finish shown



* Other finishes available to special order

Contact us for help and advice on your next project.

0800 171 2907

estimating@hafele.co.uk

hafele.co.uk

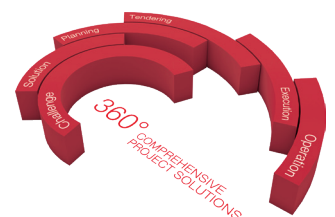

PROJECTS 360°

SOFT-TOUCH PULL HANDLE 316 STAINLESS / EPOXY RESIN PROJECTS CODE: HUKP-0101-26

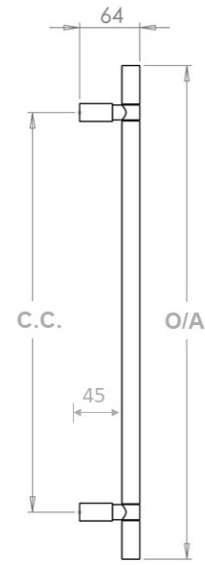

PRODUCT FEATURES

- > Pull handle Soft-Touch straight design section on pillars
- > Hole centres standard at: 300, 425, 600, 900 and 1000mm
- > For overall length, please add 100mm to hole centres dimension
- > Fixing types: Bolt through, Back to Back or Secret fixing
- > To suit doors up to 60mm thick and glass doors 8-12mm

QUALITY MARKS

- > Manufactured in grade 316 stainless steel and overlaid in epoxy resin for a more comfortable soft touch

PERFORMANCE GUARANTEE

- > 25 Years

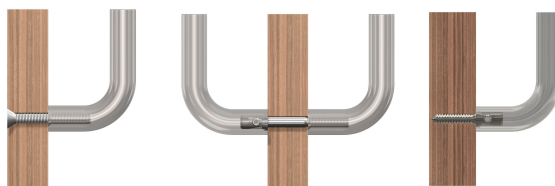

Bolt through

Back to Back

Secret Fixing

FINISHES

- > Dual finish shown:
Satin St/ Steel & Dark Grey (RAL 7021)

- > Pillars and Stem:



Satin Stainless



Polished Stainless Steel

- > Soft-Touch Mid-Section:



Matt Black
(RAL 9005)



Dark Grey
(RAL 7021)

Contact us for help and advice on your next project.

0800 171 2907

estimating@hafele.co.uk

hafele.co.uk

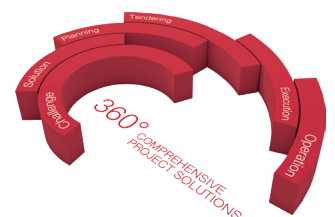

PROJECTS 360°

FLAT BAR PULL HANDLE ON PILLARS 316 STAINLESS STEEL PROJECTS CODE: HUKP-0101-36

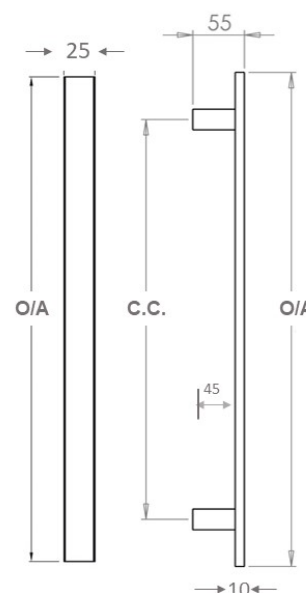
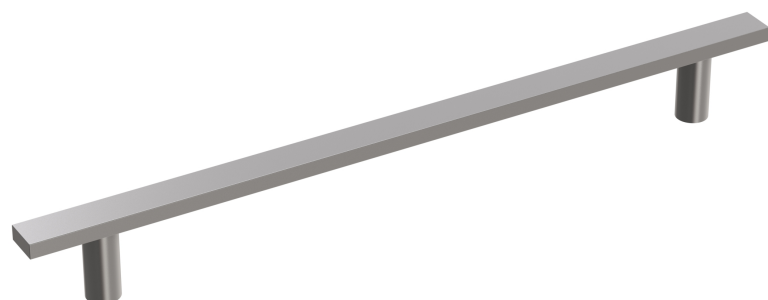

PRODUCT FEATURES

- > Pull handle 25mm section flat bar design on pillars
- > Hole centres standard at: 300, 425, 600, 900 and 1000mm
- > For overall length, please add 100mm to hole centres dimension
- > Fixing types: Bolt through, Back to Back or Secret fixing
- > Available in 20mm flat section
- > To suit doors up to 60mm thick and glass doors 8-12mm

QUALITY MARKS

- > Manufactured in grade 316 stainless steel

PERFORMANCE GUARANTEE

- > 25 Years

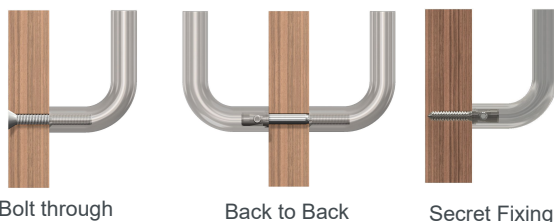

Bolt through

Back to Back

Secret Fixing

FINISHES

- > Satin Stainless Steel finish shown



* Other finishes available to special order

Contact us for help and advice on your next project.

0800 171 2907

estimating@hafele.co.uk

hafele.co.uk

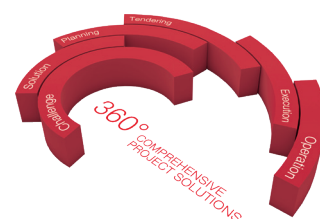

PROJECTS 360°

SQUARE PULL HANDLE

316 STAINLESS STEEL 20mm
PROJECTS CODE: HUKP-0101-42

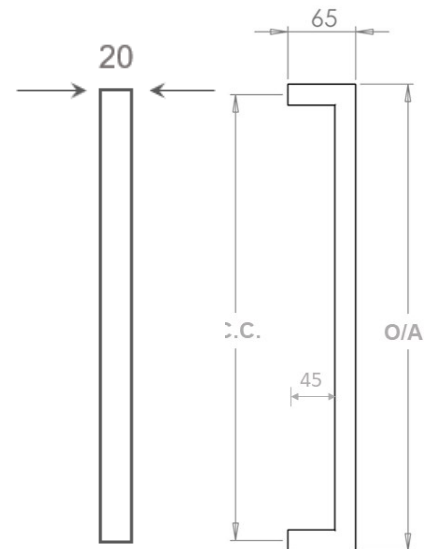
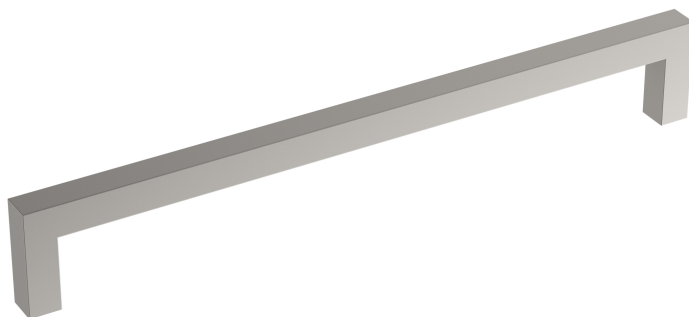

PRODUCT FEATURES

- > Pull handle in stainless steel 20mm or 25mm square section
- > Hole centres standard at: 300, 425, 600, 900 and 1000mm
- > Fixing types: Bolt through, Back to Back or Secret fixing
- > To suit doors up to 60mm thick and glass doors 8-12mm

QUALITY MARKS

- > Manufactured in grade 316 stainless steel

PERFORMANCE GUARANTEE

- > 25 Years



FINISHES

- > Satin Stainless Steel finish shown



* Other finishes available to special order

Contact us for help and advice on your next project.

0800 171 2907

estimating@hafele.co.uk

hafele.co.uk

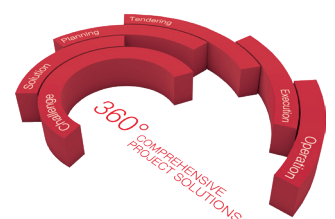

PROJECTS 360°

PULL HANDLE STRAIGHT 316 GRADE STAINLESS STEEL Ø 22mm PROJECTS CODE: HUKP-0101-63

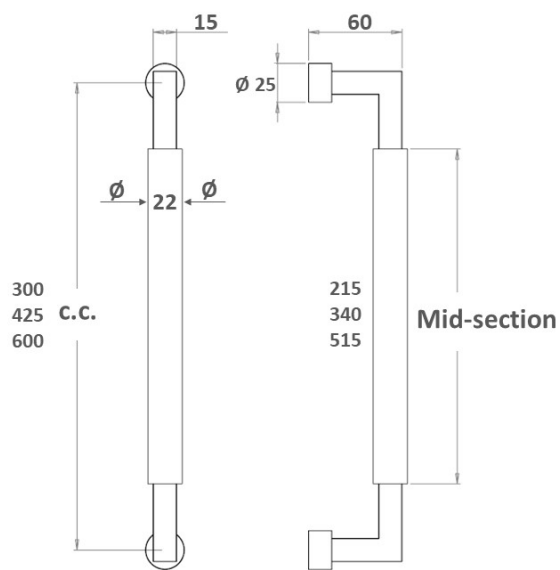

PRODUCT FEATURES

- > Straight design pull handle solid bar stainless steel section
- > Hole centres standard at: 300,425 and 600mm
- > Diameter Ø 22mm with 15 x 15mm square elbows
- > Fixing types: Bolt Through, Back to Back or Secret fixing
- > To suit doors up to 60mm thick and glass doors 8-12mm

QUALITY MARKS

- > Manufactured in grade 316 stainless steel

PERFORMANCE GUARANTEE

- > 25 Years

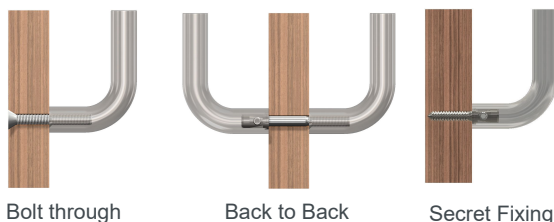

FINISHES

- > Satin Stainless Steel finish shown



* Other finishes available to special order

Contact us for help and advice on your next project.

0800 171 2907

estimating@hafele.co.uk

hafele.co.uk

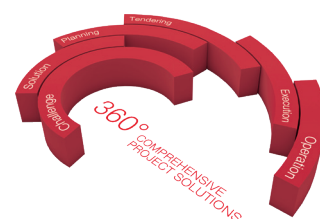

PROJECTS 360°

FSB 6550 PULL HANDLE

PROJECTS CODE: **HUKP-0401-46**

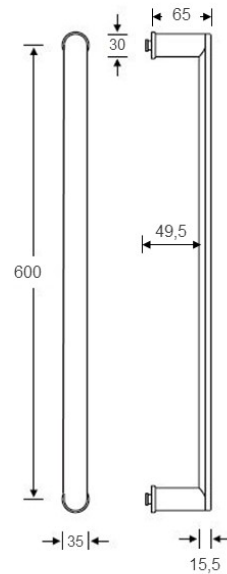

PRODUCT FEATURES

- > FSB In-Line pull handle aluminium in flat design on face
- > Curved on back of pull for ergonomic grip
- > Circular stems mitred onto end of pull handle
- > Overall length standard: 600mm
- > Back to Back application shown >



FIXING DETAIL

- > Fixing types: Bolt through, Back to Back or Secret fixing
- > To suit doors up to 60mm thick and glass doors 8-10mm

PERFORMANCE GUARANTEE



- > 25 Years



FINISHES

- > Aluminum - Black Shot-Blasted finish shown



* Aluminium Shot-Blasted finish

Contact us for help and advice on your next project.

0800 171 2907

estimating@hafele.co.uk

hafele.co.uk

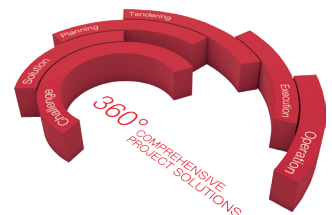

PROJECTS 360°

FSB 6552 CRANKED PULL HANDLE 450mm ALUMINIUM

PROJECTS CODE: **HUKP-0401-47**

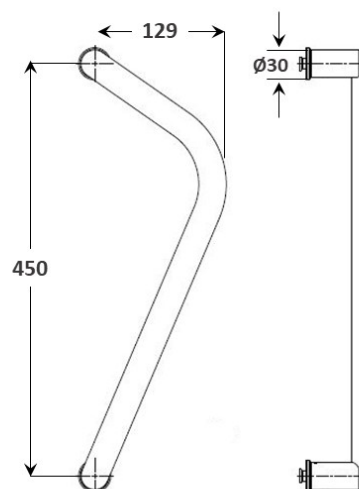

PRODUCT FEATURES

- > FSB Cranked pull handle in a flat design on face
- > Back to Back application shown
- > Circular stems 30mm mitred onto end of pull handle
- > Overall length standard: 450mm - Handed (right hand shown)
- > Aluminium

FIXING DETAIL

- > Fixing types: Bolt through, Back to Back or Secret fixing
- > To suit doors up to 60mm thick and glass doors 8-10mm

FINISHES

- > Satin Anodised finish shown



Matt Black*



Light Bronze*



Medium Bronze*



Dark Bronze*



Satin Anodised



RAL Colour

PERFORMANCE GUARANTEE



- > 25 Years



Bolt through

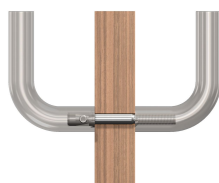

Back to Back



Secret Fixing

* Aluminium Shot-Blasted finish

Contact us for help and advice on your next project.

0800 171 2907

estimating@hafele.co.uk

hafele.co.uk



PROJECTS 360°

FSB 6551 PULL CRANKED PULL HANDLE 450mm ALUMINIUM PROJECTS CODE: HUKP-0401-48

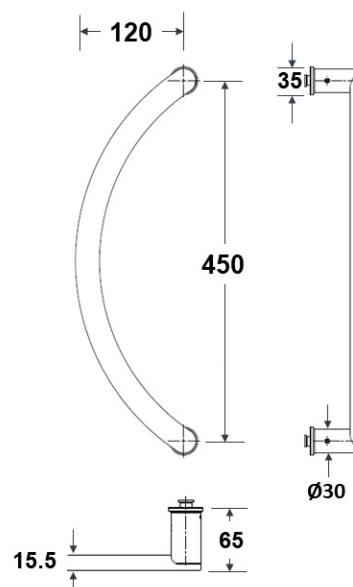

PRODUCT FEATURES

- > FSB Cranked symmetrical pull handle in a flat design on face
- > Bolt through application shown
- > Circular stems 30mm mitred onto end of pull handle
- > Overall length standard: 450mm - Handed (right hand shown)
- > Aluminium

FIXING DETAIL

- > Fixing types: Bolt through, Back to Back or Secret fixing
- > To suit doors up to 60mm thick and glass doors 8-10mm

PERFORMANCE GUARANTEE



- > 25 Years



FINISHES

- > Matt Black finish shown



Matt Black*



Light Bronze*



Medium Bronze*



Dark Bronze*



Satin Anodised



RAL Colour

* Aluminium Shot-Blasted finish

Contact us for help and advice on your next project.

0800 171 2907

estimating@hafele.co.uk

hafele.co.uk



PROJECTS 360°

PULLHANDLE SPIRAL DESIGN SOLID BRASS PROJECTS CODE: HUKP-0301-11

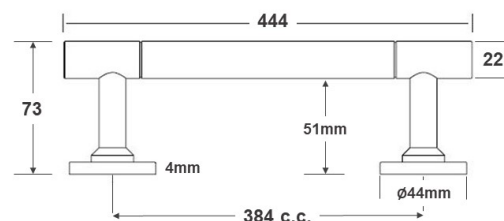

PRODUCT FEATURES

- > Brass pull handle spiral / sunburst design on 4mm roses
- > Ringed ends (options for plain ends and without rose available)
- > Lengths available: 348mm, 444mm and 600mm
- > Options on 19mm, 22mm and 25mm Ø available

INSTALLATION

- > Supplied with M8 Bolt for bolt through fixing
- > Options for back to back also available
- > 44mm Ø rose with 4mm depth shown

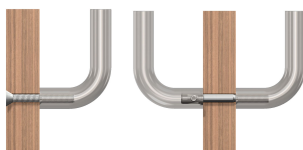

PERFORMANCE GUARANTEE

- > 10 Years



* Refer to 0301 Finishes data sheet for a full list of available finishes

Contact us for help and advice on your next project.

0800 171 2907

estimating@hafele.co.uk

hafele.co.uk

FINISHES*

- > Polished Chrome finish shown



Polished Chrome

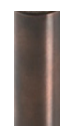

Chestnut Bronze



Matt Black Nickel



Satin Brass



Polished Nickel



Ebony Bronze



Satin Copper



Satin Nickel



Pearl Nickel



PROJECTS 360°

PULLHANDLE DIAMOND MESH SOLID BRASS PROJECTS CODE: HUKP-0301-12

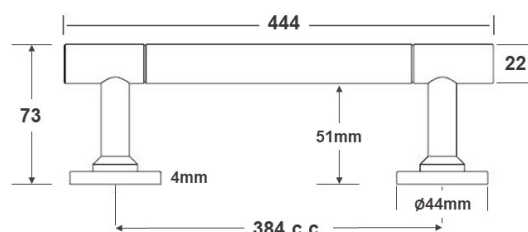

PRODUCT FEATURES

- > Brass pull handle diamond mesh design on 4mm depth roses
- > Plain ends (options for ringed ends and without rose available)
- > Lengths available: 348mm, 444mm and 600mm
- > Options on 19mm, 22mm and 25mm Ø available

OPTIONAL ACCESSORIES

- > Supplied with M8 Bolt for bolt through fixing
- > Options for back to back also available
- > 44mm Ø rose with 4mm depth shown

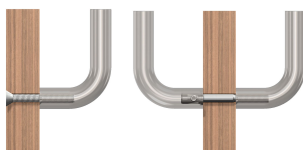

PERFORMANCE GUARANTEE

- > 10 Years



* Refer to 0301 Finishes data sheet for a full list of available finishes

Contact us for help and advice on your next project.

0800 171 2907

estimating@hafele.co.uk

hafele.co.uk

FINISHES*

- > Chestnut Bronze finish shown

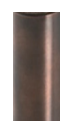

Chestnut Bronze



Polished Chrome



Matt Black Nickel



Satin Brass



Polished Nickel



Ebony Bronze



Satin Copper



Satin Nickel



Pearl Nickel



PROJECTS 360°

PULLHANDLE LINEAR SOLID BRASS PROJECTS CODE: HUKP-0301-15

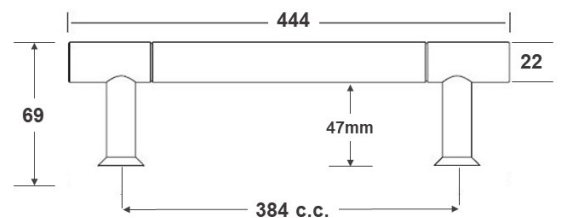

PRODUCT FEATURES

- > Brass pull handle linear design on plain pillars
- > Plain ends (options for ringed ends and with roses available)
- > Lengths available: 348mm, 444mm and 600mm
- > Options on 19mm, 22mm and 25mm Ø available

OPTIONAL ACCESSORIES

- > Supplied with M8 Bolt for bolt through fixing
- > Options for back to back also available

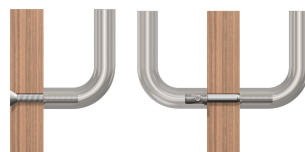

PERFORMANCE GUARANTEE

- > 10 Years



* Refer to 0301 Finishes data sheet for a full list of available finishes

Contact us for help and advice on your next project.

0800 171 2907

estimating@hafele.co.uk

hafele.co.uk

FINISHES*

- > Ebony Bronze / Satin Copper finish shown



Chestnut Bronze



Polished Chrome



Matt Black Nickel



Satin Brass



Polished Nickel



Ebony Bronze



Satin Copper



Satin Nickel



Pearl Nickel

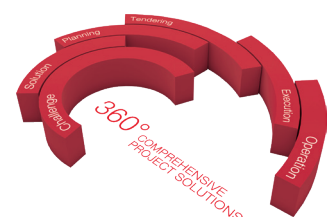

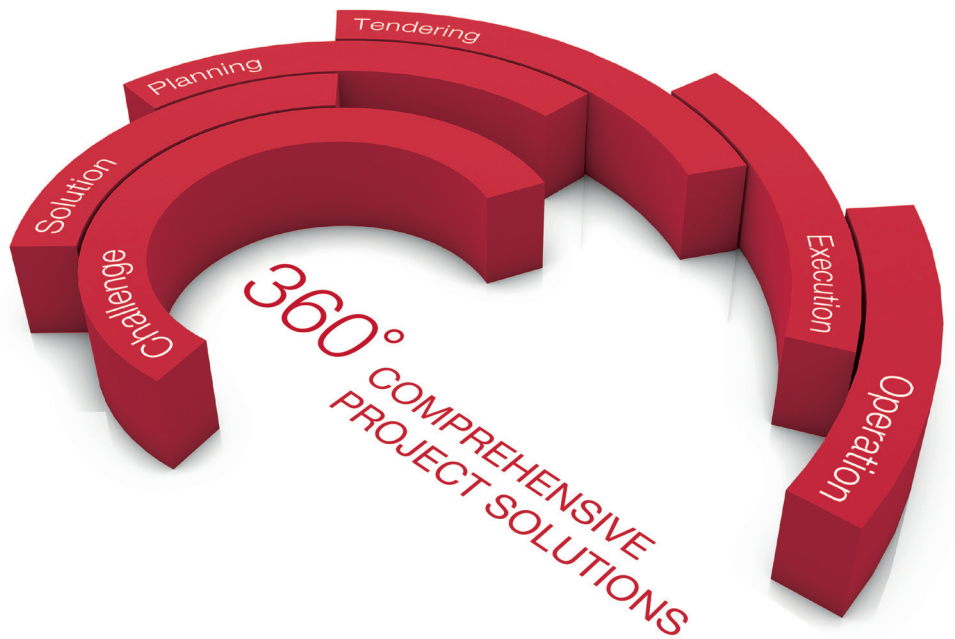

HÄFELE



0800 171 2907



hafele.co.uk/projects



estimating@hafele.co.uk

Häfele UK Ltd, Brownsover Road, Swift Valley Industrial Estate, Rugby, Warwickshire CV21 1RD