

Geberit AquaClean app

Operating the shower toilet using the app

The following shower toilet functions can be executed via the Geberit AquaClean app:

- remote control of the Geberit AquaClean shower toilet
- adjustment of the device settings

The Geberit AquaClean app offers the following additional benefits:

- saving your personal settings on your smartphone
- support for care and maintenance of the device
- easy registration of your Geberit AquaClean shower toilet
- function films
- service and contact information

The Geberit AquaClean app is available free of charge for Android and iOS smartphones in the respective app stores.

iOS:



Android:



GEBERIT AQUACLEAN SELA QUICK GUIDE



What you need for cleaning

Selecting suitable cleaning agents and cleaning equipment

The Geberit AquaClean cleaning set (art. no. 242.547.00.1) includes a ready-made cleaning agent that is optimal for cleaning all Geberit AquaClean surfaces.



CAUTION

Cleaning with aggressive descaling and cleaning agents can cause surface damage.

- Only use Geberit AquaClean descaling agent in the device.
- Only use cleaning agents permitted by Geberit.

Geberit AquaClean consumables



Geberit AquaClean cleaning set (art. no. 242.547.00.1)



Geberit AquaClean descaling agent (art. no. 147.040.00.1)

Permissible cleaning agents



Only skin-friendly cleaning agents



Only liquid cleaning agents



Preferably water-diluted cleaning agents



Cleaning agents with a low acid content (e.g. heavily diluted citric acid)



Mildly foaming cleaning agents

Permissible cleaning equipment



Soft, fine-pored sponges



Lint-free, soft cloths which are free of dust



Toilet brush

The device at a glance

Geberit AquaClean Sela

- 1 WC lid
- 2 Remote control with magnetic wall-mounted holder
- 3 WC seat ring
- 4 Spray arm with spray nozzle and Lady shower nozzle

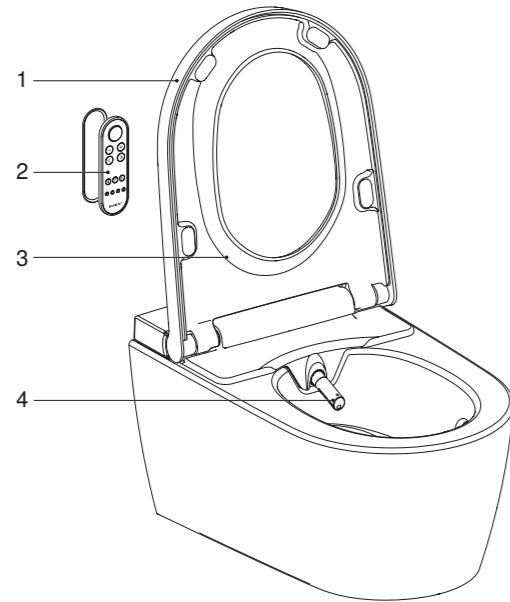

Assigning the remote control

Switch on the device, then press and hold the <+> button on the remote control for approximately 30 seconds until <Pairing ok> appears on the rear display.

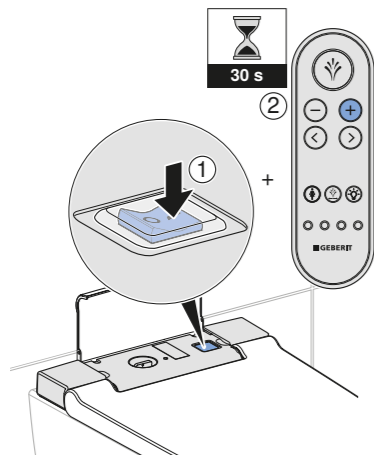

The remote control at a glance

Front side of the remote control

All functions for daily use can be operated from the front side of the remote control.

- 1 <Shower> button
- 2 <->/<+> buttons
- 3 <left>/<right> arrow keys
- 4 <Lady shower> button
- 5 <Oscillating motion> button
- 6 <Orientation light> button
- 7 User profile buttons

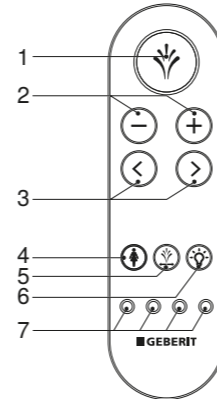

i User profiles allow you to access your personal settings directly. You can save 4 user profiles.

Rear side of the remote control

Individual functions can be selected from the rear side of the remote control.

- 1 Battery compartment
- 2 LCD display
- 3 <up>/<down>, <left>/<right> arrow keys

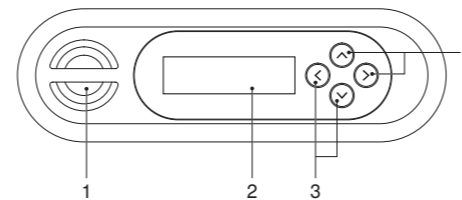

How to use the device

Using the anal shower

Press the <Shower> button once to switch on the anal shower.

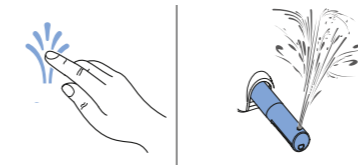

i Press the <Shower> button again to stop the shower procedure early.

Setting the spray intensity

Press the <+> button to increase the spray intensity in stages.

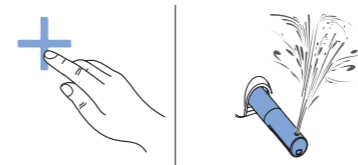

Press the <-> button to decrease the spray intensity in stages.

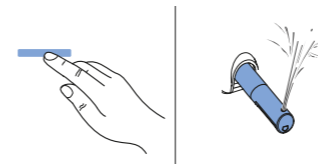

i You can set the spray intensity in 5 stages.

Setting the spray arm position

Press the arrow keys to position the spray arm.

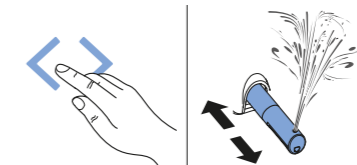

i You can set the spray arm position in 5 stages.

Using the Lady shower

Press the <Lady shower> button once to switch on the Lady shower.

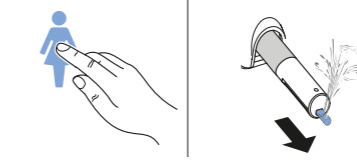

i Press the <Lady shower> button again to stop the shower procedure early.

Switching on the oscillating motion

Press the <Oscillating motion> button to start the oscillating motion of the anal shower.

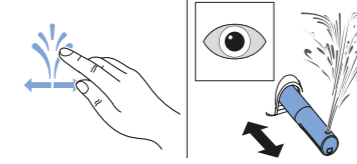

i Press the <Oscillating motion> button again to switch off the oscillating spray early.

Switching on the orientation light

Press the <Orientation light> button to switch on the orientation light.

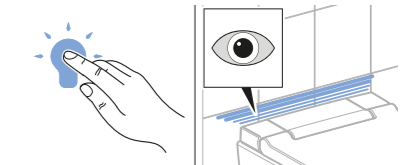

i Press the <Orientation light> button again to switch off the orientation light.

Saving user profiles

Press and hold one of the user profile buttons for 2 seconds to save the current settings as the user profile for this button.

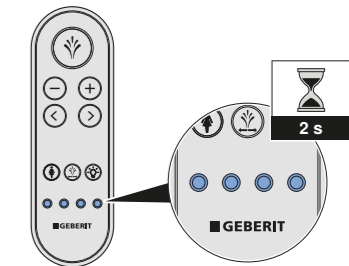

i Press the user profile button again to activate your user profile.