

**GEBERIT AQUACLEAN MERA  
CLASSIC**

**GEBERIT**



**USER MANUAL**



# Table of contents

<b>For your safety .....</b>	<b>5</b>
Who is this product suitable for? .....	5
How is this product used? .....	5
What should you avoid? .....	5
Misuse .....	5
General safety notes .....	6
Explanation of warning notes .....	7
Overview of symbols on the product .....	8
<b>Getting to know your device .....</b>	<b>9</b>
About Geberit AquaClean devices .....	9
Functional overview .....	9
The device at a glance .....	10
<b>Operating concept.....</b>	<b>12</b>
About the operating concept .....	12
Front side of the remote control .....	12
Rear side of the remote control .....	13
Lateral control panel.....	13
Status LED on the lateral control panel.....	14
Geberit AquaClean app.....	14
Switching on the device.....	15
Switching off the device.....	16
Restore to factory settings.....	16
<b>How to use the device .....</b>	<b>17</b>
Getting started.....	17
Using the anal shower.....	17
Switching the oscillating motion of the anal shower on and off.....	18
Using the Lady shower.....	18
Use the dryer.....	18
<b>Adjusting the shower procedure to your personal needs .....</b>	<b>19</b>
Setting the spray intensity .....	19
Setting the spray arm position.....	19
Saving user profiles.....	19
Calling up user profiles.....	20
Saving your personal user profile in the Geberit AquaClean app .....	20
<b>How to program the device .....</b>	<b>21</b>
Overview of the programming options.....	21
Basic settings main menu .....	22
Profile settings main menu .....	24
Care and maintenance main menu .....	26

<b>Cleaning and descaling the device .....</b>	<b>28</b>
General cleaning recommendations.....	28
Suitable cleaning agents and cleaning equipment.....	28
Automatic water replacement.....	30
Targeted disinfection.....	30
Caring for and cleaning smooth surfaces.....	30
Cleaning the flushing area of the WC ceramic appliance .....	31
Cleaning the WC seat ring .....	31
Cleaning the WC lid and housing.....	32
Cleaning the dryer arm and spray nozzle.....	33
Descaling the device .....	35
Device descaling message.....	37
<b>Troubleshooting .....</b>	<b>38</b>
Troubleshooting.....	38
The shower toilet is without function .....	39
Other functional errors.....	40
The remote control is without function.....	41
Replacing the remote control battery .....	42
Re-assigning the remote control .....	42
Replacing the ceramic honeycomb filter .....	42
<b>Sustainability .....</b>	<b>44</b>
Geberit Group and sustainability.....	44
Ecodesign – ecobalance .....	44
Tips for reducing the ecological footprint.....	44
<b>Disposal .....</b>	<b>45</b>
Disposal of old electrical and electronic equipment .....	45
Constituents .....	45
<b>End user warranty.....</b>	<b>46</b>
End user warranty .....	46
<b>Technical data and conformity .....</b>	<b>47</b>
Technical data .....	47
Simplified EU Declaration of Conformity .....	47

## For your safety

---

### Who is this product suitable for?

As a functioning toilet, the Geberit AquaClean shower toilet is suitable for all age groups. However, children must not carry out cleaning or maintenance work without supervision.

### How is this product used?

The product is suitable for the following application purposes and areas of use:

- as a shower toilet:
  - for cleaning the anal area
  - for cleaning the outer vaginal area
  - for odour extraction
- for installation in heated indoor areas
- for connection to the drinking water system
- for operation with water from reverse osmosis systems

### What should you avoid?

The product must be used as intended. Do not:

- leave the WC seat ring during the shower procedure
- place loads or objects on the WC lid
- immerse the remote control in liquid
- operate without plug for Geberit AquaClean descaling agent

### Misuse

Geberit accepts no liability for the consequences arising from misuse.

## General safety notes

The following safety notes apply for the entire duration of the product's life cycle:

- Read the user manual before the first use to familiarise yourself with the use of the product.
- Store the user manual for future reference.
- Impurities in the filter could lead to contamination of the breathing air. In order to preclude any health risks and ensure proper functioning, the filter must be replaced annually.
- Do not use the device if it is damaged. If possible, isolate the device from the supply system and contact Geberit customer service.
- Do not open the device. It does not contain any components for the user to service or repair.
- Do not perform any changes or additional installations. Modifying the device runs the risk of fatal danger.
- Repairs may only be carried out by authorised skilled persons using original spare parts.
- Only original accessories may be used.
- Operation and maintenance work may only be performed by the operator or user as described in this user manual.
- Always use the current version of the installation manual for installing the device if the Geberit AquaClean has been removed (e.g. if you move house).
- The Geberit AquaClean must only be connected to a mains voltage conforming to the specification plate.
- Observe the manufacturer information at all times regarding the use of cleaning and descaling agents.

---

 This document contains warning notes at various points. Warning notes are usage and situation-specific safety notes. They provide warnings on specific hazards.

---

 These instructions correspond to the state of the device technology at the time of printing. Geberit reserves the right to make changes in terms of further development.

A current version of this and other documents is available online: [www.geberit.com](http://www.geberit.com).

## Explanation of warning notes

Warning notes are placed at the location at which the hazard may occur.

Warning notes are structured as follows:

---





### **WARNING**

#### **Nature and source of the hazard**



Possible consequences if the hazard is ignored.

- ▶ Measures to prevent the hazard.

The following signal words are used to indicate residual hazards in warning notes and important information.

Symbol	Signal word and meaning
	<b>DANGER</b> The signal word denotes a hazard with a high degree of risk which, if not avoided, will result in death or serious injury.
	<b>CAUTION</b> The signal word denotes a hazard with a low degree of risk which, if not avoided, could result in minor or moderate injury.
	<b>ATTENTION</b> The signal word denotes a hazard, which, if not avoided, may result in material damage.
	Symbol only. Refers to important information

### Overview of symbols on the product

Symbol	Meaning
	Read the safety notes and operating instructions/ operation manual before commissioning the product.
	Danger of fatal electric shock

# Getting to know your device

---

## About Geberit AquaClean devices

The Geberit AquaClean device is a WC with integrated shower function. The device fulfils all the functions of a conventional toilet. Additional functions are subject to the design of your product.

## Functional overview

Hygiene functions:

- TurboFlush technology
- odour extraction in the WC ceramic appliance
- WhirlSpray shower technology with individual spray arm position
- spray arm with oscillating motion
- extendible Lady shower nozzle integrated into the spray nozzle with individual spray arm position
- automatic shower arm cleaning before and after each shower procedure
- dryer functionality via dryer arm
- descaling programme

Comfort functions:

- spray intensity can be selected
- WC seat ring and WC lid with SoftClosing
- remote control with LCD display
- all functions can be operated via remote control
- 4 individual user profiles can be stored
- shower toilet functions can be operated via a lateral ergonomic control panel

## The device at a glance

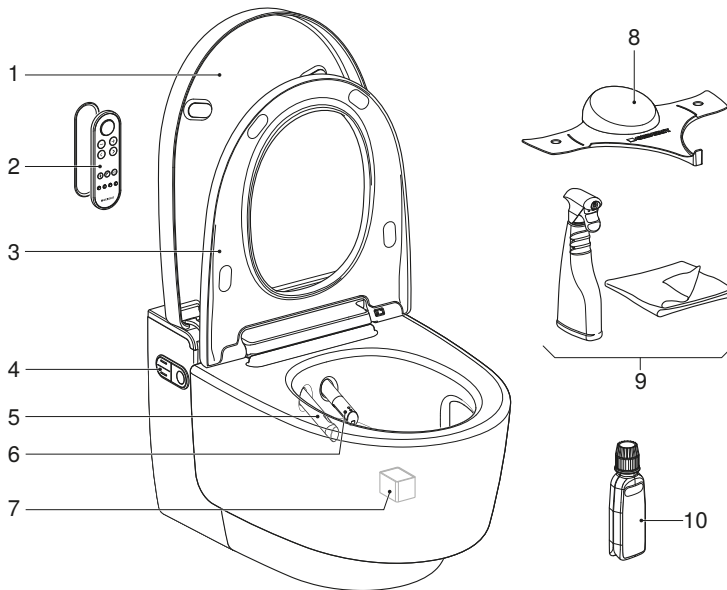

- 1 WC lid
- 2 Remote control with magnetic wall-mounted holder
- 3 WC seat ring with user recognition and QuickRelease function
- 4 Lateral control panel with status LED
- 5 Dryer arm with dryer nozzle
- 6 Spray arm with spray nozzle and Lady shower nozzle
- 7 Ceramic honeycomb filter (art. no. 242.999.00.1)
- 8 Spray shield
- 9 Geberit AquaClean cleaning set (art. no. 242.547.00.1)
- 10 Geberit AquaClean descaling agent (art. no. 147.040.00.1)



# Operating concept

---

## About the operating concept

The shower toilet can be operated via remote control, the lateral control panel on the shower toilet and the Geberit AquaClean app.

## Front side of the remote control

All functions for daily use can be operated from the front side of the remote control.

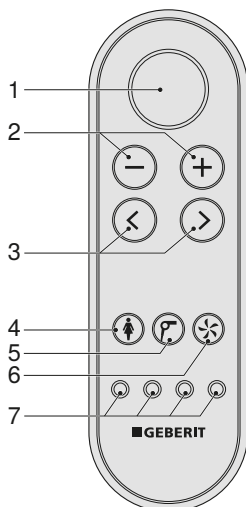

- 1 <Shower> button: start and stop the spray functionality/stop the dryer functionality and Lady shower.
- 2 <->/<+> buttons: decrease or increase the spray intensity.
- 3 <left>/<right> arrow keys: set the spray arm position.
- 4 <Lady shower> button: start and stop the Lady shower.
- 5 <Dryer> button: start and stop the dryer.
- 6 <Odour extraction> button: start and stop odour extraction.
- 7 <User profile> buttons: activate the user profiles 1–4.

## Rear side of the remote control

You can access system settings and additional functions from the rear side of the remote control.

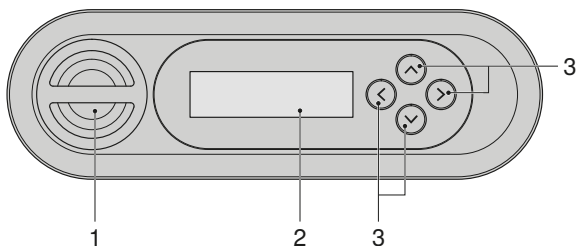

- 1 Battery compartment
- 2 LCD display
- 3 <up>/<down>, <left>/<right> arrow keys

## Lateral control panel

The shower toilet functions of the device can be operated from the lateral control panel on the shower toilet.

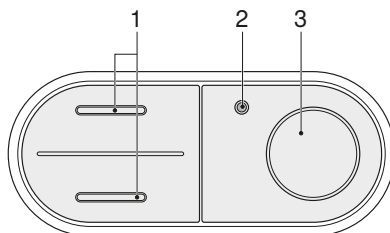

- 1 <up>/<down> buttons: decrease or increase the spray intensity
- 2 Status LED
- 3 <Shower> button: start or stop the anal shower or the Lady shower

## Status LED on the lateral control panel

The status LED on the lateral control panel informs you of the current device status. The current condition of the device is therefore visible.

Status LED	Description
Does not light up	Heating element is switched off/economy mode is active.
Lights up blue	The heating element is switched on.
Flashes blue	The device initialises after switching on.
Lights up green	The ceramic honeycomb filter must be replaced. → See "Replacing the ceramic honeycomb filter", page 42.
Flashes red	A malfunction message is pending. ▶ If [Error message] is displayed on the remote control: contact customer service.
Flashes blue-red	The device must be descaled. → See "Descaling the device", page 35.
Lights up orange	The device is now descaling. It is not possible to use the shower toilet for the duration of the descaling procedure.
Flashes orange	Water replacement is being carried out. → See "Automatic water replacement", page 30.

## Geberit AquaClean app

The following shower toilet functions can be executed via the Geberit AquaClean app:

- remotely controlling the Geberit AquaClean shower toilet
- displaying and adjusting the settings

The Geberit AquaClean app offers the following additional benefits:

- saving your personal settings on your smartphone
- support for care and maintenance of the device
- easy registration of your Geberit AquaClean shower toilet
- function films
- service and contact information

The Geberit AquaClean app is available free of charge for Android and iOS smartphones in the respective app stores.

Android:



iOS:



The range of functions available in the Geberit AquaClean app may vary from country to country.

## Switching on the device

- i** Wait at least 30 seconds between the switch-off and switch-on procedures.

- 1** Open the design cover.

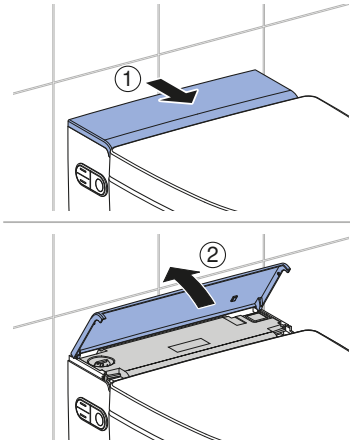

- 2** Turn on the power switch to start initialisation.  
✓ The blue status LED flashes during initialisation.

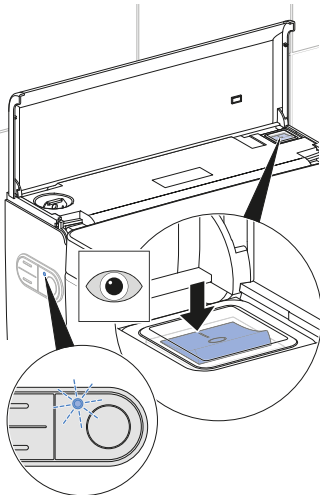

- 3** Close the design cover.

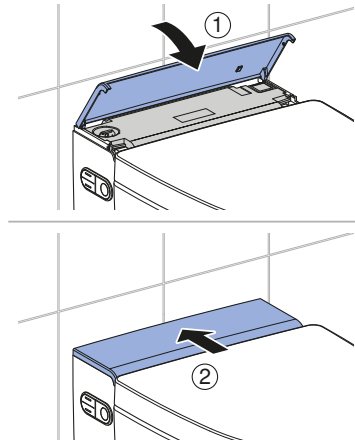

### Result

- ✓ When the blue status LED goes out, initialisation is complete.

## Switching off the device

- i** Wait at least 30 seconds between the switch-off and switch-on procedures.

**1** Close the WC lid.

**2** Open the design cover.

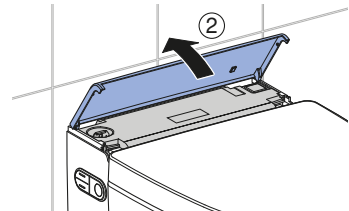
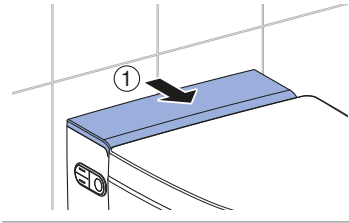

**3** Press the power switch.

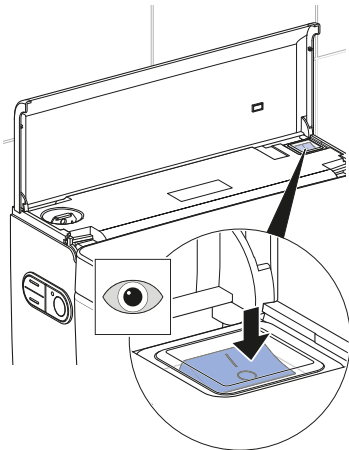

**4** Close the design cover.

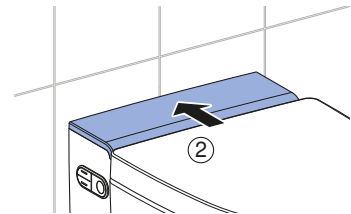
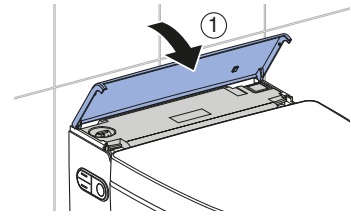

## Restore to factory settings

### Prerequisite

- You want to reset your personal settings and restore the factory settings as the basic settings.

- ▶ Hold down the <User profile> buttons on the outer right and left for more than 2 seconds.

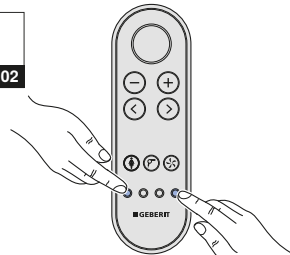

### Result

- ✓ The shower toilet is reset to its factory settings.

# How to use the device

---

## Getting started

When using the device, the following functions should take place.

When you sit down on the WC seat ring,

- the water heating starts.
- the device enables the spray functionality.
- the odour extraction unit starts.
- the basic settings are activated automatically.

When you start the shower procedure,

- the shower procedure will run for more than 30 seconds.
- the shower procedure can be interrupted at any time.
- the shower procedure can be adapted to your personal requirements.
- you can change the basic settings and adapt these to your personal requirements.

When you get up from the WC seat ring,

- the spray functionality deactivates.
- the dryer functionality deactivates.
- the spray nozzle and Lady shower nozzle are rinsed thoroughly.
- the device is set to economy mode.

## Using the anal shower

### Prerequisite

- You are sitting down on the WC seat ring.

- 
- 1** Press the <Shower> button on the remote control.

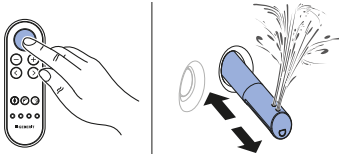

- 
- 2** Or: press the <Shower> button on the lateral control panel.

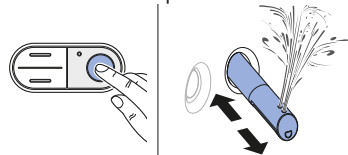

### Result

- ✓ The shower procedure starts with the oscillating motion.

- 
- i** You can stop the shower procedure early by pressing the <Shower> button once again.

## Switching the oscillating motion of the anal shower on and off

**i** The oscillating motion of the spray arm increases the cleaning effect.

### Prerequisite

- The shower procedure is running.

- ▶ Press the [left] and [right] arrow keys at the same time to switch the oscillating motion off and on during the shower procedure.

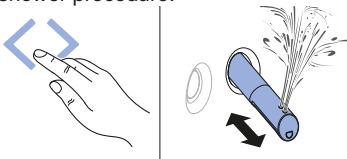

## Using the Lady shower

**i** The woman's intimate area is a very sensitive zone and requires special and prudent care. The Lady shower must be set to your ergonomic conditions to achieve an optimal cleaning result. The position of the spray nozzle and the spray intensity must be selected so that the shower spray cannot penetrate the vagina.

### Prerequisite

- You are sitting down on the WC seat ring.

- 1** Press the <Lady shower> button on the remote control.

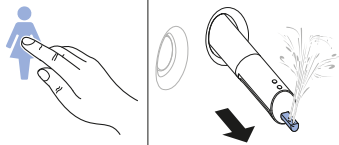

- 2** Or: press the <Shower> button on the lateral control panel for 2 seconds.

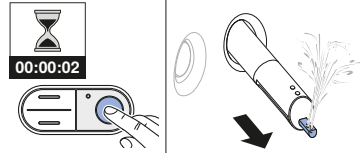

### Result

- ✓ The Lady shower switches on and the shower procedure starts.

**i** You can stop the shower procedure early by pressing the <Lady shower> button once again.

## Use the dryer

### Prerequisite

- You have ended the shower procedure.

- ▶ Press the <Dryer> button on the remote control.

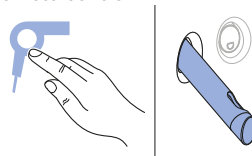

### Result

- ✓ The drying procedure starts.

**i** You can stop the drying procedure early by pressing the <Dryer> button once again.

# Adjusting the shower procedure to your personal needs

## Setting the spray intensity

### Prerequisite

- The shower procedure is running.
- The spray intensity can be set in 5 levels.

- 1 Press the <+> button on the remote control.

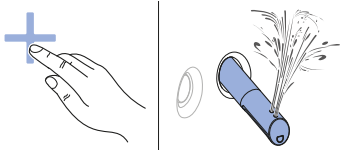

- 2 Press the <-> button on the remote control.

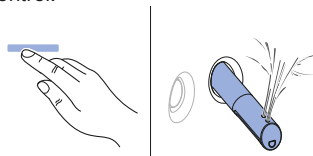

- 3 Or: press the <top> or <bottom> button on the lateral control panel.

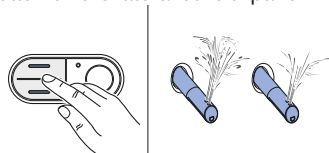

### Result

- ✓ This adapts the shower spray.

## Setting the spray arm position

### Prerequisite

- The shower procedure is running.

- The spray arm position can be set in 5 levels.

- ▶ Touch the <left> or <right> button.
  - ✓ The spray arm moves forwards or backwards.

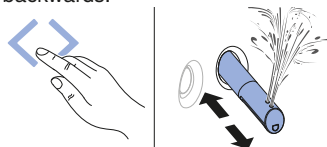

### Result

- ✓ The spray arm is optimally positioned.

## Saving user profiles

- ▶ Press one of the 4 user profile buttons for more than 2 seconds to save the current settings.

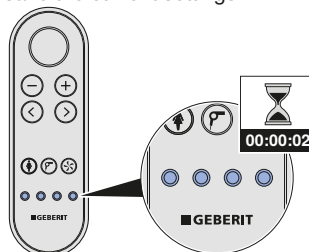

- ▶ The following functions can only be configured from the rear side of the remote control:

- shower water temperature
- warm air temperature

→ See "Profile settings main menu", page 24.

## Calling up user profiles

---

- i** User profiles allow you to access your personal settings directly. Select your user profile as soon as you sit down.

### Prerequisite

- Personal user profiles are stored on the <User profile> buttons. → See Saving user profiles.

- ▶ Press the <User profile> button on which your personal settings are stored.

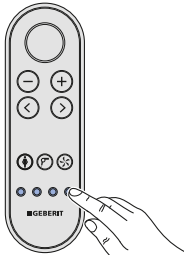

### Result

- ✓ Your personal user profile is called up and activated.

## Saving your personal user profile in the Geberit AquaClean app

---

- i** As long as you are in the detection range of the shower toilet, you do not need to activate the user recognition in order to save your user profile in the Geberit AquaClean app.

### Prerequisite

- The current version of the Geberit AquaClean app is installed on your smartphone.
- The Geberit AquaClean app is running.
- You are in the detection range of the shower toilet.

- ▶ Save your settings in the Geberit AquaClean app.

### Result

- ✓ Your personal user profile is saved onto your smartphone.
- ✓ The settings apply to all connected shower toilets.

# How to program the device

---

## Overview of the programming options

The following main menus are available:

- [Basic settings]
- [Profile settings]
- [Care and maintenance]

The system settings can be configured from the rear side of the remote control:

- Press any button on the rear side of the remote control to activate the display.
- Pressing the <up> arrow key for more than 2 seconds returns the display to the [Basic settings] menu.
- To save the modified settings, the menu must be run through in its entirety until the main menu appears once again on the display.
- The display is automatically deactivated after 30 seconds to save battery life.

## Basic settings main menu

- 1 Launch the [Basic settings] main menu using the <left>/<right> arrow keys on the rear side of the remote control.

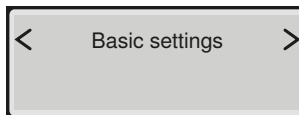
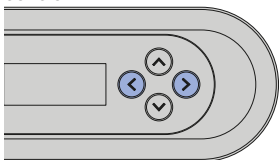

- 2 Use the <up>/<down> arrow keys to access the next menu item.

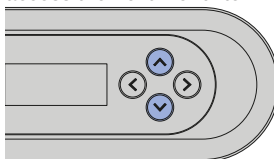

Shown on display	Note
	Select the language of the display
	Spray intensity of the anal shower
	Spray arm position of the anal shower
	Spray intensity of the Lady shower
	Spray arm position of the Lady shower
	Temperature regulation of the shower water
	<p>[on] = The oscillating motion of the spray arm is activated.</p> <p>[off] = The oscillating motion of the spray arm is deactivated.</p>

Shown on display	Note
<div style="border: 1px solid black; padding: 5px; text-align: center;">           Dryer            &lt; off <u>on</u> &gt;         </div>	<p>[on] = The dryer functionality starts automatically after the spray functionality.            [off] = The dryer functionality is deactivated.</p>
<div style="border: 1px solid black; padding: 5px; text-align: center;">           Dryer heating            &lt; off ██████████ &gt;         </div>	<p>Temperature regulation of the dryer</p>
<div style="border: 1px solid black; padding: 5px; text-align: center;">           Odour extraction            &lt; off <u>on</u> &gt;         </div>	<p>[on] = The odour extraction unit starts as soon as a user is detected on the WC.            [off] = The odour extraction unit is deactivated.</p>
<div style="border: 1px solid black; padding: 5px; text-align: center;">           Run-on of odour extr.            &lt; <u>off</u> on &gt;         </div>	<p>[on] = The odour extraction unit continues running for 2 minutes afterwards.            [off] = The odour extraction unit does not continue running afterwards.</p>
<div style="border: 1px solid black; padding: 5px; text-align: center;">           Water hardness            &lt; <u>hard</u> &gt;         </div>	<p>Adaptable hardness value:            hard/medium/soft            → See "Device descaling message",            page 37</p>
<div style="border: 1px solid black; padding: 5px; text-align: center;">           System flush            &lt; <u>off</u> on &gt;         </div>	<p>[on] = The system flush starts as soon as a user is detected on the WC.            [off] = The system flush starts before the shower procedure as soon as the &lt;Shower&gt; button is pushed.            If the system flush is switched off, then the flush time before the end of the shower procedure is approx. 15 seconds.</p>
<div style="border: 1px solid black; padding: 5px; text-align: center;">           Autom. flush actuation            &lt; <u>off</u> &gt;         </div>	<p>This menu only appears if the optional interface module for the external flush actuation is installed.            [off] = Automatic flush actuation is deactivated.            [on] = The flush actuates automatically once the user has left the user recognition range.            [Preflush] = The flush actuates after starting the shower and after leaving the user recognition range.</p>

## Profile settings main menu

- 1 Launch the [Profile settings] main menu using the <left>/<right> arrow keys on the rear side of the remote control.

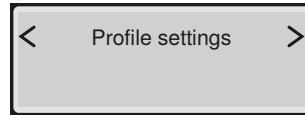
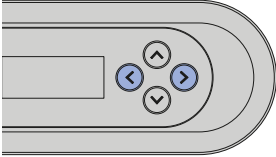

- 2 Use the <up>/<down> arrow keys to select the settings which you would like to change.

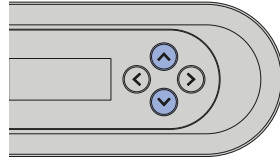

Shown on display	Note
	Corresponds to the user profile buttons on the front side of the remote control
	Spray intensity of the anal shower
	Spray arm position of the anal shower
	Spray intensity of the Lady shower
	Spray arm position of the Lady shower
	Temperature regulation of the shower water

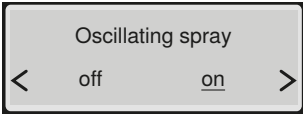
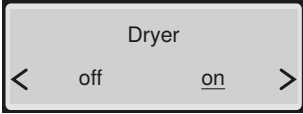
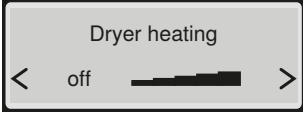
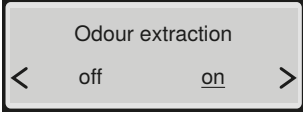
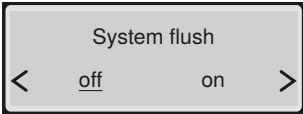
Shown on display	Note
	<p>[on] = The oscillating motion of the spray arm is activated.  [off] = The oscillating motion of the spray arm is deactivated.</p>
	<p>[on] = The dryer functionality starts automatically after the spray functionality.  [off] = The dryer functionality is deactivated.</p>
	<p>Temperature regulation of the dryer</p>
	<p>[on] = The odour extraction unit starts as soon as a user is detected on the WC.  [off] = The odour extraction unit is deactivated.</p>
	<p>[on] = The system flush starts as soon as a user is detected on the WC.  [off] = The system flush starts before the shower procedure as soon as the &lt;Shower&gt; button is pushed.  If the system flush is switched off, then the flush time before the end of the shower procedure is approx. 15 seconds.</p>

## Care and maintenance main menu

- 1 Launch the [Care and maintenance] main menu using the <left>/<right> arrow keys on the rear side of the remote control.

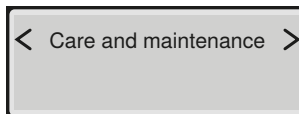
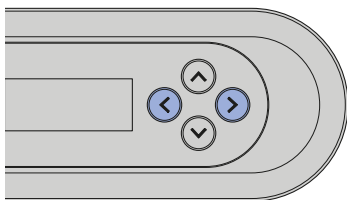

- 2 Use the up/down arrow keys to access the next menu item.

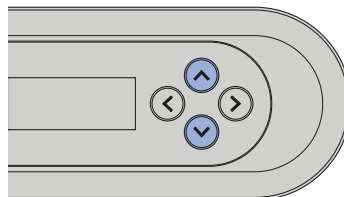

Shown on display	Note
	Display in days until the next descaling
	[yes] = Start descaling. → See "Descaling the device", page 35. [no] = Continue with the [Filter replaced?] menu
	The descaling procedure should not be cancelled after adding the descaling agent because it would otherwise be flushed away unused. The display shows [Device is flushing...].
	Status message regarding the automatic descaling procedure

Shown on display	Note
<div style="border: 1px solid black; padding: 5px; text-align: center;">           Descaling completed         </div>	
<div style="border: 1px solid black; padding: 5px;">           Filter replaced?            &lt; <u>no</u>      yes &gt;         </div>	Confirmation of the filter replacement. → See "Replacing the ceramic honeycomb filter", page 42. [yes] = Filter replaced [no] = Continue with the [Show device info] menu
<div style="border: 1px solid black; padding: 5px;">           Show device info            &lt; <u>no</u>      yes &gt;         </div>	[yes] = Display of the device information [no] = Continue with the [Error message] menu
<div style="border: 1px solid black; padding: 5px; text-align: center;">           Model            AquaClean Mera Classic         </div>	Type/equipment version
<div style="border: 1px solid black; padding: 5px; text-align: center;">           Article number            146.xxx.xxx.         </div>	Geberit article number
<div style="border: 1px solid black; padding: 5px; text-align: center;">           Serial number            GBxxxxxxxxxx         </div>	Device serial number (required in case of service)
<div style="border: 1px solid black; padding: 5px; text-align: center;">           Commissioning date            dd.mm.yyyy         </div>	Date the device was first switched on
<div style="border: 1px solid black; padding: 5px;">           Error message            xxxxx         </div>	An error code is only displayed in the event of an error. → See "Status LED on the lateral control panel", page 14.
<div style="border: 1px solid black; padding: 5px;">           Demonstration mode            &lt; <u>off</u>      on &gt;         </div>	[on] = Switch on demonstration mode [off] = Cancel
<div style="border: 1px solid black; padding: 5px;">           Activate mode?            &lt; <u>no</u>      yes &gt;         </div>	Safety query for activating demonstration mode

# Cleaning and descaling the device

---

## General cleaning recommendations

Cleaning the shower toilet at the recommended cleaning intervals will ensure that it functions properly. The shower toilet must only be cleaned using suitable cleaning agents and cleaning equipment. → See "Suitable cleaning agents and cleaning equipment", page 28.

Cleaning interval	Cleaning activity
Daily	▶ Remove water drops with a soft, lint-free cloth to avoid limescale stains.
Weekly	▶ Clean all surfaces and corners thoroughly. → See "Cleaning the WC lid and housing", page 32. ▶ Test spray nozzle and clean if required. → See "Cleaning the dryer arm and spray nozzle", page 33. ▶ Rinse the spray nozzle under running water to remove foreign substances.
Monthly	▶ Clean the WC ceramic appliance with Geberit AquaClean cleaning agent. → See "Cleaning the flushing area of the WC ceramic appliance", page 31.

## Suitable cleaning agents and cleaning equipment

---

### ATTENTION

#### Aggressive descaling agents

Inappropriate descaling agents can damage the device.

- ▶ Only use Geberit AquaClean descaling agent for descaling.

### ATTENTION





#### Aggressive and scouring cleaning agents



Cleaning using aggressive and scouring cleaning agents can cause surface damage.

- ▶ Use Geberit AquaClean cleaning agents.

Using the Geberit AquaClean cleaning set is recommended, as this set includes a ready-made cleaning agent that is ideal for cleaning all Geberit AquaClean surfaces.

Recommended properties of suitable cleaning agents and cleaning equipment for best cleaning results:

Symbol	Properties of suitable cleaning agents
	Skin-friendly
	Cleaning agents are permitted to have a low acid content, e.g. heavily diluted citric acid
	Low-foaming
	Liquid
	Water-dilutable

Symbol	Suitable cleaning equipment
	Soft, fine-pored sponges
	Lint-free, soft cloths which are free of dust
	Toilet brush

## Automatic water replacement

If the shower toilet has not been used for more than 2 months, the device is rinsed with fresh water after it is switched on. This ensures optimum shower water quality before usage.

## Targeted disinfection

Disinfection is only required if there is a definite risk of infection as a result of germs. Otherwise, keep to the recommended cleaning intervals and carry out the specified cleaning activities. → See "General cleaning recommendations", page 28.

---

## ATTENTION

### Aggressive disinfectants

Disinfection using aggressive disinfectants can cause surface damage.

- ▶ Only use alcohol-based disinfectants that are also suitable for hand and skin disinfection.
- ▶ Observe the safety notes from the manufacturer when handling hazardous substances.

Type of disinfection	Disinfection procedure
<b>Wet wipe disinfection</b> For use on smooth surfaces that can be rubbed	<ul style="list-style-type: none"><li>▶ Moisten all surfaces with disinfectant.</li><li>▶ Allow the disinfectant to take effect according to the manufacturer information.</li><li>▶ Then rub the surfaces with single-use towels.</li></ul>

## Caring for and cleaning smooth surfaces

All smooth surfaces can be cleaned hygienically with water and a mild, liquid cleaning agent that is kind to the skin.



Aggressive and scouring cleaning agents can damage the surface. Only use mild, liquid cleaning agents that are kind to the skin. The Geberit AquaClean cleaning set (art. no. 242.547.00.1) includes a ready-made cleaning agent that is optimal for cleaning all Geberit AquaClean surfaces.

## Cleaning the flushing area of the WC ceramic appliance

- 1 Spray the WC ceramic appliance with Geberit AquaClean cleaning agent and allow the cleaning agent a few minutes to take effect.
- 2 Afterwards, rinse the WC ceramic appliance with water.
- 3 Remove stubborn stains with a toilet brush.

## Cleaning the WC seat ring

The WC seat ring can be removed easily for simple cleaning.



Be careful not to scratch the surface of the WC seat. Always place the components on a soft, non-scratching underlay.

- 1 Place the WC seat ring in the vertical position.

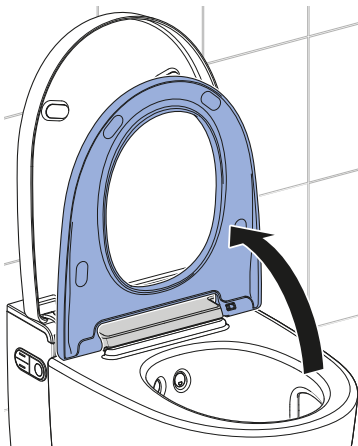

- 2 Slide the release button to the right and lift the WC seat ring out of the right-hand bracket.

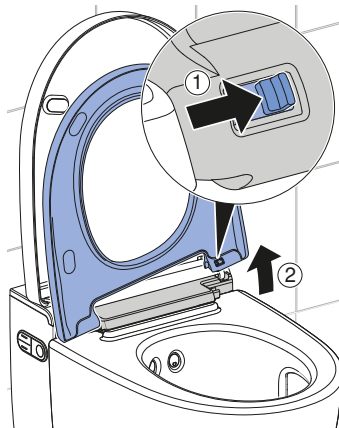

- 3 Slide the WC seat ring out of the left-hand hinge.

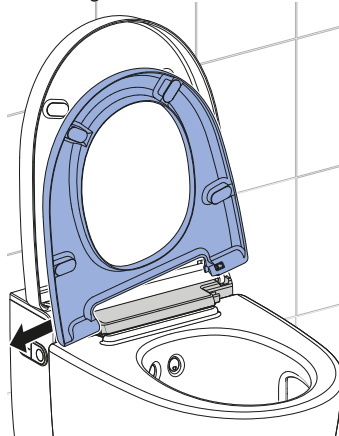

✓ The WC seat ring is removed and can be cleaned.

- 4 Spray the surfaces with Geberit AquaClean cleaning agent.

- 5 Wipe the surfaces with a soft, lint-free, damp cloth.

---

**6** Then dry the surfaces with a soft, lint-free cloth.

---

**7** After cleaning is complete, re-assemble the device in reverse order of disassembly.

---

## Cleaning the WC lid and housing

**i** Be careful not to scratch the surface of the WC seat. Always place the components on a soft, non-scratching underlay.

---

**1** Open the design cover.

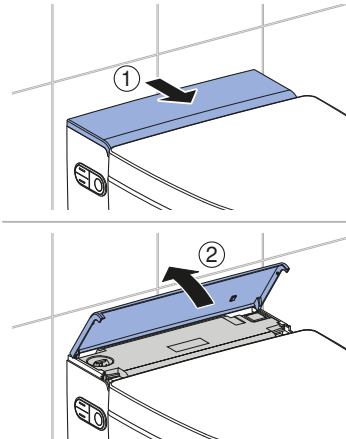

---

**2** Open the WC lid.

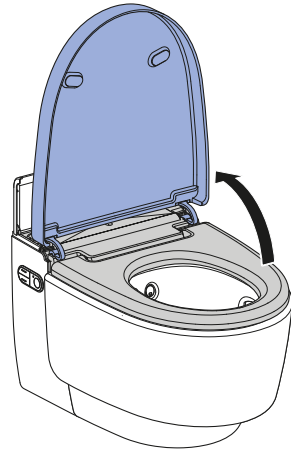

---

**3** Lift the WC lid vertically out of its position.

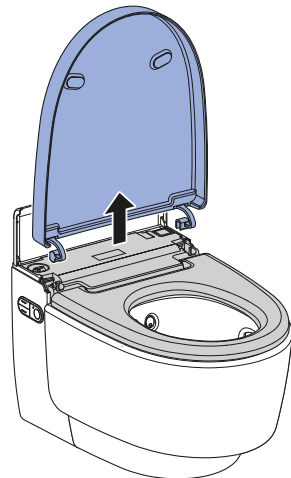

---

**4** Spray the surfaces with Geberit AquaClean cleaning agent. Wipe the surfaces with a soft, lint-free, damp cloth.

---

**5** Then dry the surfaces with a soft, lint-free cloth.

---

**6** After cleaning is complete, re-assemble the device in reverse order of disassembly.

---

## Cleaning the dryer arm and spray nozzle

---

- i**
- For cleaning, use a soft, lint-free cloth.
  - Geberit AquaClean cleaning agent is particularly suitable for all surfaces of the device.
- 

**1** Open the WC lid.

---

**2** Place the WC seat ring in the vertical position.

---

**3** Press the <up> button and the <Shower> button at the same time.

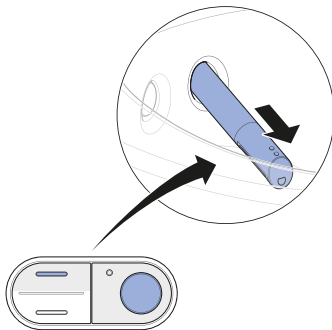

✓ The spray arm extends fully.

---

**4** Twist the spray arm in any direction and remove it.

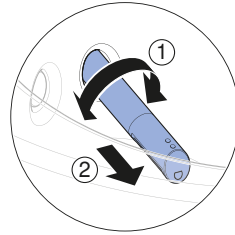

---

**5** Pull out the spray nozzle for cleaning and descaling.

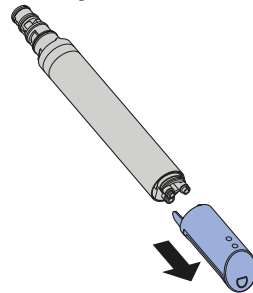

---

**6** Replace the spray nozzle if it can no longer be completely cleaned and descaled.

---

**7** Spray the spray arm with Geberit AquaClean cleaning agent. Then rinse the spray arm with water.

---

**8** Dry both parts carefully before re-assembling and re-fitting the spray arm.

---

- 
- 9** Press the <Shower> button to extend the dryer arm.

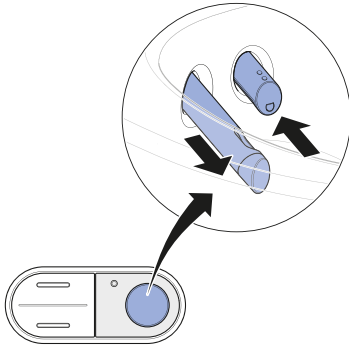

✓ The spray arm retracts and the dryer arm extends.

- 
- 10** Unlock the dryer arm by turning it 90° to the left. Pull the dryer arm out.

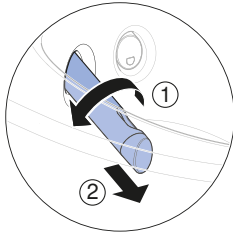

- 
- 11** Press the unlock button on the rear side of the dryer arm and pull out the dryer nozzle.

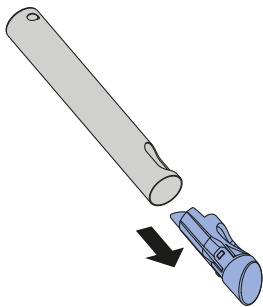

- 
- 12** Clean the dryer arm and dryer nozzle. Dry both parts carefully before re-assembling the dryer arm.

- 
- 13** Replace the dryer nozzle if it can no longer be completely cleaned.

- 
- 14** Press the <Shower> button on the lateral control panel.

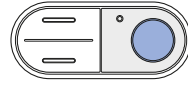

✓ The dryer arm retracts completely.

---

**Result**

✓ The cleaning procedure is now complete.

## Descaling the device

Information on descaling:

- During the descaling procedure, you can continue to use the device without the shower toilet functions.
- The descaling procedure lasts up to 60 minutes. During this time, the LED lights up orange and you can see the descaling status on the display. Once the orange LED switches off, the spray functionality is once again ready for operation.

## ATTENTION

### Aggressive descaling agents

Inappropriate descaling agents can damage the device.

- ▶ Only use Geberit AquaClean descaling agent for descaling.



The descaling procedure should not be cancelled after filling the descaling agent because it would otherwise be flushed away unused. The display shows [Device is flushing...].

### Prerequisite

- The LED on the control panel flashes blue-red.
- At the push of a button, the display shows [Descalce device now] or [Descalce device now, device blocked] on the rear side of the remote control.

- 1 Open the design cover.

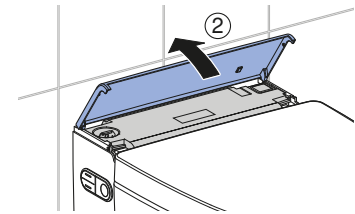
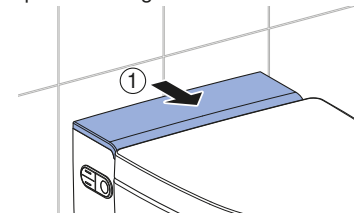

- 2 Remove the plug.

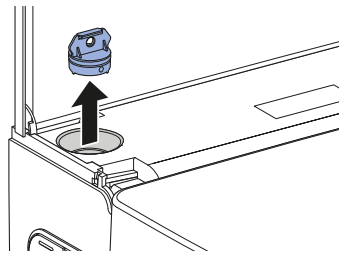

- 3 Launch the [Care and maintenance] main menu using the buttons on the rear side of the remote control.

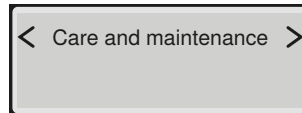

- 4 Use the <down> arrow key to select the [Descalce device now?] menu item.

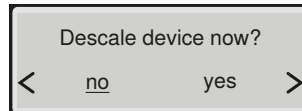

**5** Use the arrow keys to select <yes>.

- ✓ The display shows

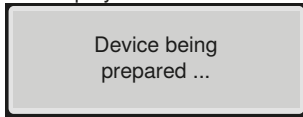

**6** Wait until the device is ready for descaling.

- ✓ The display shows

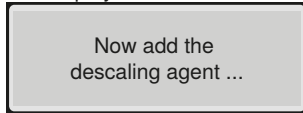

**7** Pour a bottle (125 ml) of Geberit AquaClean descaling agent into the filling opening.

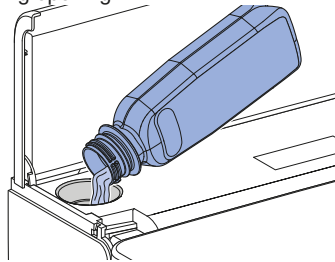

**8** Re-insert the plug.

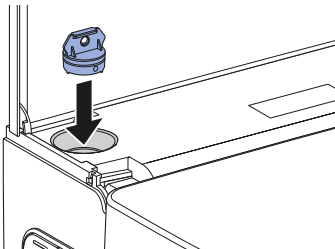

**9** Remove splashes of descaling agent immediately with a damp cloth.

**10** Close the design cover.

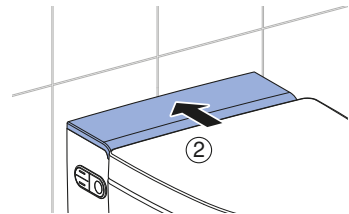
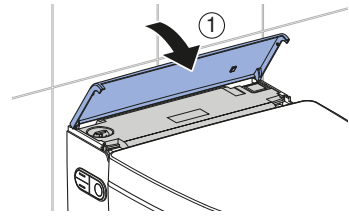

**11** Use the arrow key to start the descaling procedure.

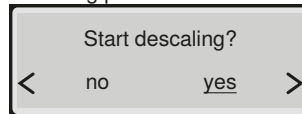

- ✓ A status message appears on the display which shows the duration of the descaling procedure.

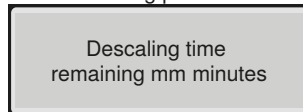

- ✓ The status LED on the control panel lights up orange until the descaling procedure is complete.

## Device descaling message

During installation, the device was configured for the local water hardness in accordance with the following table. This adaptation prevents unnecessary descaling procedures and helps protect the environment. Nevertheless, regular descaling of the device is required.

Range	°fH	°dH	°eH
soft	≤ 15	≤ 8	≤ 11
medium	15–25	8–14	11–18
hard	> 25	> 14	> 18

The following table helps you to identify descaling messages and to carry out the necessary fault clearance for each message.

Cause	Message	Fault clearance
Regular descaling: at least once a year	<ul style="list-style-type: none"> <li>The status LED on the control panel flashes blue-red.</li> <li>The display shows [Descal device now].</li> </ul>	<ul style="list-style-type: none"> <li>▶ Perform descaling. → See "Descaling the device", page 35.</li> </ul>
Locked device: multiple rejected descaling requests	<ul style="list-style-type: none"> <li>The status LED on the control panel flashes blue-red.</li> <li>The display shows [Descal device now, device locked].</li> </ul>	<p><b>Prerequisite</b></p> <ul style="list-style-type: none"> <li>– A shower procedure is no longer possible without descaling.</li> <li>▶ Perform descaling. → See "Descaling the device", page 35.</li> </ul>

# Troubleshooting

## Troubleshooting

The table below explains what you need to do in the event of a fault:

- Carry out the steps one after the other until the device is no longer demonstrating any faults or is working as normal again.
- Be sure to follow the steps in order.

Step	Description of problem	Fault clearance
1	The shower toilet is demonstrating a fault or is not working as normal.	<ul style="list-style-type: none"><li>▶ Switch off the device. → See "Switching off the device", page 16.</li><li>▶ Wait 30 seconds.</li><li>▶ Switch on the device. → See "Switching on the device", page 15.</li></ul>
2	Step 1 has been carried out. The shower toilet continues to demonstrate a fault or still does not work as normal.	<ul style="list-style-type: none"><li>▶ Test the status LED on the lateral control panel. → See "Status LED on the lateral control panel", page 14.</li></ul>
3	Steps 1 and 2 have been carried out. The shower toilet continues to demonstrate a fault or still does not work as normal.	<ul style="list-style-type: none"><li>▶ Check the problem descriptions in the faults table and carry out the relevant fault clearance as required. → See "The shower toilet is without function", page 39.</li><li>▶ Check the problem descriptions in the faults table and carry out the relevant fault clearance as required. → See "Other functional errors", page 40.</li></ul>
4	Steps 1 to 3 have been carried out. The shower toilet continues to demonstrate a fault or still does not work as normal.	<ul style="list-style-type: none"><li>▶ Contact customer service.</li></ul>

## The shower toilet is without function

The following table will help you with troubleshooting if the shower toilet is without function.



### DANGER

#### Electric shock

Incorrect maintenance work or troubleshooting can lead to serious injury or death.

- ▶ In case of malfunctions, the device must immediately be switched off at the power switch and the customer service must be contacted.
- ▶ Only trained electrically skilled persons are permitted to perform electrical installations on the device.
- ▶ Only trained professionals are permitted to perform retrofitting on the device.



The shower toilet can be used as a normal toilet even in the event of a malfunction. The spray arm and dryer arm must be fully retracted. You start the toilet flush as usual by pressing the buttons on the cistern.

Description of problem	Cause	Fault clearance
The fuse or residual-current device in the electrical distributor trips once.	Malfunction has occurred	<ul style="list-style-type: none"> <li>▶ Replace or reset the fuse in the electrical distributor.</li> <li>▶ Reset the residual-current device in the electrical distributor.</li> </ul> <p><b>Result</b></p> <ul style="list-style-type: none"> <li>✓ The device initialises again after switching on. Using the device does not trip any fuses or residual-current devices.</li> </ul>
The fuse or residual-current device in the electrical distributor trips repeatedly when the device is used.	Device is defective	<ul style="list-style-type: none"> <li>▶ Replace or reset the fuse or residual-current device in the electrical distributor.</li> <li>▶ Disconnect the mains plug (if available).</li> <li>▶ Contact customer service.</li> </ul>
The product has an unknown technical defect.	Malfunction has occurred	<ul style="list-style-type: none"> <li>▶ Trip the fuse or residual-current device in the electrical distributor.</li> <li>▶ Disconnect the mains plug (if available).</li> <li>▶ Contact customer service.</li> <li>▶ Have the power supply tested by a skilled person.</li> </ul>

## Other functional errors

The following table will help you with troubleshooting if individual functions of the shower toilet have failed.



The shower toilet can be used as a normal toilet even in the event of a malfunction. The spray arm and dryer arm must be fully retracted. You start the toilet flush as usual by pressing the buttons on the cistern.



If the device is defective, switch it off using the power switch.

Description of problem	Cause	Fault clearance
Odour neutralisation is weak or ineffective.	Ceramic honeycomb filter dirty	<ul style="list-style-type: none"> <li>▶ Replace the ceramic honeycomb filter.</li> <li>→ See "Replacing the ceramic honeycomb filter", page 42.</li> </ul>
The spray arm or dryer arm is not functioning correctly.	Malfunction has occurred	<ul style="list-style-type: none"> <li>▶ Switch off the device.</li> <li>→ See "Switching off the device", page 16.</li> <li>▶ Wait 30 seconds.</li> <li>▶ Switch on the device.</li> <li>→ See "Switching on the device", page 15.</li> </ul> <p><b>Result</b></p> <ul style="list-style-type: none"> <li>✓ The device initialises again after switching on.</li> </ul>
The cleaning effect of the shower has weakened.	Spray nozzles clogged or defective	<ul style="list-style-type: none"> <li>▶ Clean or replace the spray nozzles.</li> <li>→ See "Descaling the device", page 35.</li> </ul>
When using the shower function, the shower toilet no longer reaches the usual temperature.	Shower toilet dirty	<ul style="list-style-type: none"> <li>▶ Descal the device.</li> <li>→ See "Descaling the device", page 35.</li> <li>▶ Switch off the device.</li> <li>→ See "Switching off the device", page 16.</li> <li>▶ Wait 30 seconds.</li> <li>▶ Switch on the device.</li> <li>→ See "Switching on the device", page 15.</li> </ul> <p><b>Result</b></p> <ul style="list-style-type: none"> <li>✓ The device initialises again after switching on.</li> </ul>

## The remote control is without function

The following table will help you with troubleshooting if:

- the remote control is not functioning,
- the remote control is unable to control the shower toilet.



The remote control is inactive while the Geberit AquaClean app is in use.



Should the remote control fail to function, you can use the lateral control panel instead.



If the device is defective, switch it off using the power switch.

Description of problem	Cause	Fault clearance
The remote control display still remains unresponsive when buttons are pushed.	Pairing unsuccessful	<ul style="list-style-type: none"> <li>▶ Re-assign the remote control. → See "Re-assigning the remote control", page 42.</li> </ul> <b>Result</b> ✓ The display shows [Pairing ok].
The remote control is unable to control the shower toilet. The remote control has been re-assigned.	Batteries flat	<ul style="list-style-type: none"> <li>▶ Replace battery (type CR2032). → See "Replacing the remote control battery", page 42.</li> </ul>
	Pairing unsuccessful	<ul style="list-style-type: none"> <li>▶ Re-assign the remote control. → See "Re-assigning the remote control", page 42.</li> </ul>
The battery has been replaced and the remote control has been re-assigned. The remote control display still remains unresponsive when buttons are pushed.	Remote control defective	<ul style="list-style-type: none"> <li>▶ Contact customer service.</li> </ul>

## Replacing the remote control battery

### Prerequisite

- During the entire procedure, the remote control must be located in the reception range of the shower toilet.

- 1 Remove the used battery. Dispose of the used battery appropriately.

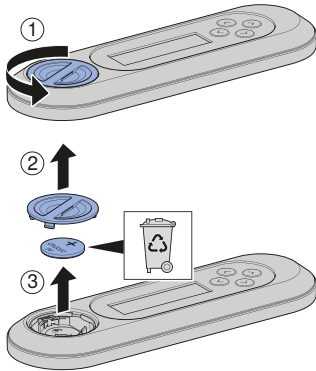

- 2 Insert a new CR2032 battery.

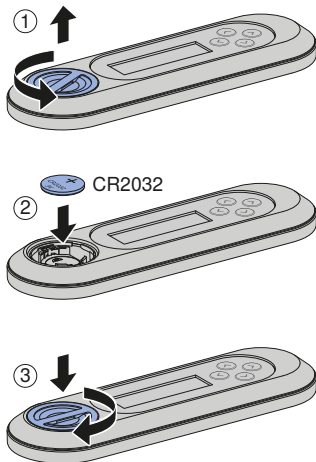

## Re-assigning the remote control

- i** The device can only be operated with a single, assigned remote control.

- ▶ Press the <+> button on the remote control and the <up> button on the lateral control panel for approx. 30 seconds until [Pairing ok] appears on the display.

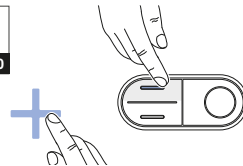
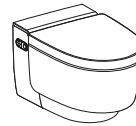

### Result

- ✓ The shower toilet can be controlled by remote control.

## Replacing the ceramic honeycomb filter



### CAUTION

#### Possible health hazard

Impurities in the filter could lead to contamination of the breathing air.

- ▶ Replace the filter annually.

- i** The ceramic honeycomb filter is located on the bottom right side of the device. It is fastened with a catch spring.

## Prerequisite

- The status LED on the control panel lights up green.
- At the push of a button, the display shows [Replace filter] on the rear side of the remote control.

- 1** Bend the catch spring gently to the side to unfasten the ceramic honeycomb filter. At the same time, remove the used filter from the bracket.

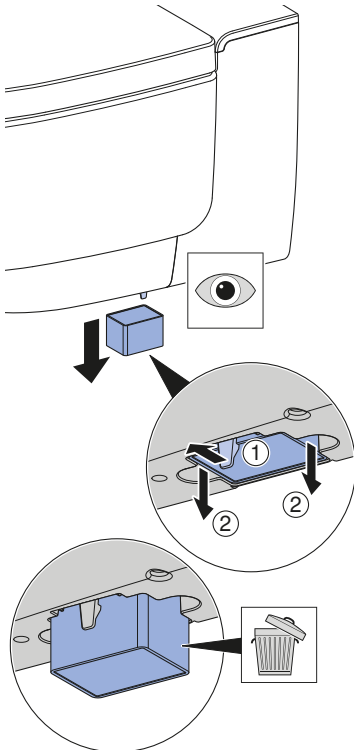

- 2** Insert the new filter.

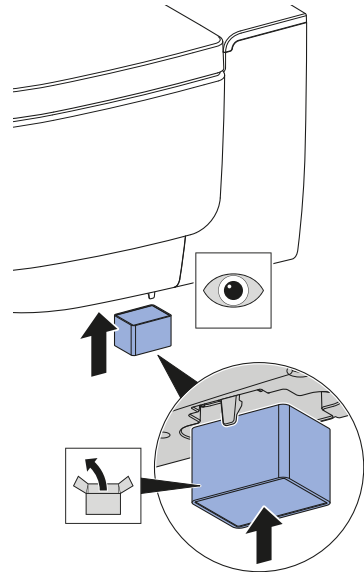

- ✓ The catch spring is used to fasten the new filter.

- 3** Launch the [Care and maintenance] main menu using the buttons on the rear side of the remote control.

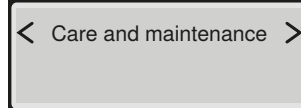

- 4** Use the <down> arrow key to select the [Filter replaced?] menu item.

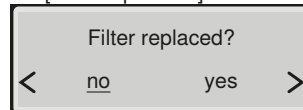

- 5** Use the arrow keys to select <yes>.

## Result

- ✓ Odour neutralisation will now function again.

# Sustainability

---

## Geberit Group and sustainability

As the European market leader in the sanitary industry, Geberit stands for water saving, resource efficiency and sustainable building. The Group has proven for decades that long-term business success is compatible with environmentally friendly actions and social policies. A company management geared to sustainability helps to save costs while minimizing risks at the same time. Geberit aims to act as a role model and set standards for its customers, suppliers and other partners. This means creating water-saving and sustainable products, using safe, environmentally friendly and resource-efficient production practices, engaging in purchasing and logistics activities with high environmental and ethical standards, and offering excellent working conditions for more than 12 000 dedicated and highly qualified employees worldwide. One way in which the company is showing its awareness of social responsibility is by participating in water relief projects around the world.

## Ecodesign – ecobalance

The basis for sustainable products is formed by a systematic innovation process in which product materials and functional principles are chosen that are as environmentally friendly as possible, risks are minimised and a high degree of resource efficiency is strived for. We can supply a detailed ecobalance for this product upon request.

## Tips for reducing the ecological footprint

This product was developed with the utmost care, also with regard to the consumption of energy, water and resources (see also technical data). You can reduce the ecological footprint of the product by observing the following recommendations:

- Switch off the device when you go on holiday.
- Interrupt the spray functionality manually in order to save hot water.
- Use small amounts of paper for drying.
- Switch off the heating function of the water heater when you do not need warm shower water.
- Use environmentally friendly cleaning agents.
- Carry out regular maintenance on the device and handle it with care in order to extend the service life.
- Return defective devices to Geberit or a designated partner for appropriate disposal.

# Disposal

---

## Disposal of old electrical and electronic equipment



■

In accordance with Directive 2012/19/EU:2012-07-04, manufacturers of electrical equipment are obliged to take back old equipment and to dispose of it appropriately. The symbol indicates that the product cannot be disposed of with non-recyclable waste. Old equipment should be returned directly to Geberit where it will be disposed of appropriately. Addresses to which equipment can be returned can be requested from the relevant Geberit sales company.

## Constituents

This product conforms to the requirements of Directive 2011/65/EU:2011-06-08 (Directive on the restriction of the use of certain hazardous substances in electrical and electronic equipment) and is free of environmental pollutants such as lead, mercury, cadmium and chrome VI.

The European chemical regulation EC Regulation 1907/2006:2006-12-18, which regulates the registration, assessment, approval and restriction of certain chemical substances, is also complied with.

# End user warranty

---

## End user warranty

The following end user warranty is provided in addition to and does not affect your contractual partner's liability for defective products.

The Geberit company ("Geberit") responsible for the place of installation of the Geberit AquaClean product ("product") shall provide the end user with a warranty for the product identified by the serial number on the warranty card. The scope of this warranty is as follows:

1. Geberit guarantees that the product shall be free from material defects and manufacturing faults for a period of 3 years ("warranty period") calculated from the installation date at the end user's premises. Warranty scope:
  - a) Within the first 2 years of the warranty period, a customer service representative authorised by Geberit shall rectify any material defects or manufacturing faults free of charge by repairing or replacing the defective parts.
  - b) In the third year of the warranty period, Geberit shall supply replacements for defective parts free of charge to the customer service representative authorised by Geberit and contracted by the end user to repair the product.
2. The end user shall not be entitled to assert more extensive claims against Geberit on the basis of this warranty.
3. Claims can only be made under the warranty if:
  - a) the product has been installed and put into operation by an installation company or by customer service personnel authorised by Geberit.
  - b) no modifications have been made to the product; in particular, no parts have been removed, replaced or added.
  - c) the product defect has not been caused by improper installation or use, nor can it be attributed to inadequate care or maintenance.
  - d) claims shall only be made during the third year of the warranty period if the end user has completed the enclosed warranty card in full and returned it to the Geberit company responsible for the place of installation within 90 working days of the installation date.
4. This warranty applies solely to places of installation in countries in which Geberit has its own sales company or is represented by a sales partner.
5. The warranty is exclusively subject to the substantive law of the country in which Geberit has its place of business. The United Nations Convention on Contracts for the International Sale of Goods is expressly excluded. The exclusive place of jurisdiction for all disputes arising from or in connection with this warranty is the location of Geberit's headquarters.



# Technical data and conformity

---

## Technical data

Nominal voltage	230 V AC
Mains frequency	50 Hz
Power consumption	2000 W
Power consumption standby	≤ 0.5 W
Protection degree	IPX4
Protection class	I
Frequency range	2400 MHz–2483.5 MHz
Maximum output power	0 dBm
Wireless technology	Bluetooth® Low Energy <sup>1)</sup>
Mains connection	Mains connection via system plug with flexible three-wire sheathed cable
Spray time	30–50 s
Number of shower pressure settings, shower spray	5
Water temperature	34–40 °C
Operating temperature	5–40 °C
Flow pressure	50–1000 kPa
	0.5–10 bar
Minimum flow pressure	50 kPa
	0.5 bar
Calculated flow rate	0.03 l/s
Maximum load, WC seat	150 kg

<sup>1)</sup> The Bluetooth® brand and its logos are the property of Bluetooth SIG, Inc. and are under licence by Geberit.

## Simplified EU Declaration of Conformity

Hereby, Geberit International AG, declares that the radio equipment type Geberit AquaClean Mera is in compliance with Directive 2014/53/EU.

The full text of the EU declaration of conformity is available at the following internet address: <https://doc.geberit.com/968860000.pdf>.

**(CH) Geberit Vertriebs AG**  
Schachenstrasse 77  
CH-8645 Jona  
T 0848 882 982  
www.geberit-aquaclean.ch

**(DE) Geberit Vertriebs GmbH**  
Kundendienst/Servicestelle  
Theuerbachstrasse 1  
D-88630 Pfullendorf  
T (075 52) 934 10 11  
F (075 52) 934 866  
www.geberit-aquaclean.de

**(AT) Geberit Vertriebs GmbH & Co. KG**  
Geberitstrasse 1  
A-3140 Pottenbrunn / St. Pölten  
T +43 2742 401-400  
F +43 2742 401-50  
www.geberit-aquaclean.at

**(AE) Geberit International Sales AG**  
Dubai Branch  
B702-B705  
Building No. 1  
Dubai Design District  
PO Box  
UAE-282317 Dubai  
T +971 4 204 5477  
F +971 4 204 5497  
www.geberit.ae

**(BE) Geberit nv**  
Beaulieustraat 6  
B-1830 Machelen  
T +32 2 252 0111  
F +32 2 251 0867  
www.geberit-aquaclean.be

**(BG) Юнитрейд Интернешънъл ЕООД**  
бул. "Черни връх" 161-А  
1407 София  
T 02/ 968 11 11  
F 02/ 968 10 01  
www.unitrade-bg.com

**(CN) 吉博力(上海)贸易有限公司**  
地址: 上海市嘉定区南翔高科技  
园区惠平路1515号  
邮编: 201802

**(CZ) Geberit spol. s r.o.**  
Sokolovská 2408/222  
190 00 Praha 9  
T +420 547 212 335  
F +420 547 212 340  
www.geberit.cz

**(DK) Geberit A/S**  
Lægårdsvej 26  
DK-8520 Lystrup  
T +45 86 74 10 86  
F +45 86 74 10 98  
www.geberit-aquaclean.dk

**(ES) Geberit, S.A.U.**  
Plaza Europa, 2-4, 6ª planta  
ES-08902 L'Hospitalet del Llobregat  
(Barcelona)  
T +34 902 170 635  
www.geberit-aquaclean.es

**(FI) Geberit Oy**  
Tahkotie 1  
FI-01530 Vantaa  
P +358 9 867 8450  
www.geberit.fi

**(FR) Geberit France**  
ZA du Bois Gasseau - CS40252  
Samoreau  
FR-77215 Avon Cedex  
Téléphone 01 60 71 66 61  
T +33(0)825 801 603  
F +33(0)825 801 604  
www.geberit-aquaclean.fr

**(GB) Geberit Sales Ltd.**  
Geberit House  
Edgehill Drive  
Warwick  
CV34 6NH  
T (0)1926 516 800  
T (0)1926 516 809  
In Eire T +44 1622 717 811  
www.geberit-aquaclean.co.uk

**(HR) Predstavništvo Geberit**  
prodaja d.o.o. Ruše  
Samoborska cesta 218  
10090 Zagreb, HR  
T +385 1 3867 800  
F +385 1 3867 801  
www.geberit.hr

**(HU) Geberit Kft**  
1117 Budapest,  
Alíz utca 2.  
T +36 1 204 4187  
www.geberit.hu

**(IT) Geberit Marketing e Distribuzione SA**  
Via Gerre 4  
CH-6928 Manno  
T +41 91 611 92 92  
F +41 91 611 93 93  
www.geberit-aquaclean.it

**(LU) Geberit Luxembourg**  
61, avenue de la Libération  
L-3850 Schifflange  
T +352 54 52 26  
F +352 54 54 91  
www.geberit.lu

**(NL) Geberit B.V.**  
Fultonbaan 15  
3439 NE Nieuwegein  
T +31 (0)3060 57700  
F +31 (0)3060 53392  
www.geberit-aquaclean.nl

**(NO) Geberit AS**  
Luhrtoppen 2  
N-1470 Lørenskog  
T +47 67 97 82 00  
www.geberit-aquaclean.no

**(PL) Geberit Sp. z o.o.**  
ul. Postępu 1  
02-676 Warszawa  
T +48 22 843 06 96  
www.geberit-aquaclean.pl

**(PT) Geberit Tecnologia Sanitária, S.A**  
Rua Cupertino de Miranda, nº 12-2º A  
PT-1600-485 LISBOA  
www.geberit.pt

**(RO) Geberit International Sales AG**  
Splaiul Unirii, Nr. 86, Et. 3  
Sector 4, Bucharest  
T +40 21 330 30 80/81  
F +40 21 330 31 61  
www.geberit.ro

**(RS) Geberit - Predstavništvo za**  
Republiku Srbiju i Republiku Crnu Goru  
Vojvode Skopljanca 24  
SR-11000 Beograd  
T + 381 11 30 96 430  
F + 381 11 30 96 431  
www.geberit.rs

**(RU) ООО „ГЕБЕРИТ РУС“**  
Олимпийский пр., 16, стр.5, 5 этаж  
129110 Москва  
тел.: +7 495 783 83 30  
www.geberit.ru

**(SE) Geberit AB**  
Folketshusgatan 1  
Box 140  
295 22 Bromölla  
T +46 40 680 89 30  
www.geberit.se

**(SI) Geberit prodaja, d.o.o.**  
Bezena 55  
2342 Ruše  
T 01 586 22 00  
F 01 586 22 19  
www.geberit.si

**(SK) Geberit Slovensko s.r.o**  
Karadžičova 10  
821 08 Bratislava 2  
T +421 2 49 20 30 71  
www.geberit.sk

**(TR) Geberit Tesisat Sistemleri Tic Ltd. ti.**  
İçerenköy Mah. Engin Sok. No. 10,  
34752 Atasehir-Ystanbul, Turkey  
T +90 216 340 82 73  
F +90 216 340 82 79  
www.geberit.com.tr

**(ZA) Geberit Southern Africa (Pty.) Ltd.**  
6 Meadowview Lane,  
Meadowview Business Estate,  
Longmeadow,  
Linbro Park  
Johannesburg,  
South Africa  
T +27 11 444 5070  
F +27 11 444 5992  
www.geberit.co.za