

Installation Instruction

Istruzioni di montaggio

Installationsanleitung

Instructions d'installation

Instrucciones de montaje

CONOS

MINI-CONOS

MICRO-CONOS

Track Lighting

Apparecchio da binario

Track Lighting

Projecteurs sur rail 230V

Luminarias para Binario

Art.

6044 6062

6045 6063

6050 6064

6051 6092

6052 6100

6054 6310

6055 6311

6056 6321

6058 6322

6061 6323

2. Installation should be carried out by a suitably qualified person in accordance with good electrical practice and the appropriate national wiring regulations.

L'installazione deve essere effettuata da personale qualificato secondo la normativa elettrica vigente.

Die Installation muss nach den gültigen Sicherheitsvorschriften durch einen konzessionierten Elektroinstallateur erfolgen.

L'installation doit être réalisée par un électricien qualifié en respectant les prescriptions en vigueur.

La instalación debe ser realizada por una persona cualificada y de acuerdo a la normativa vigente.

3. Use this light fixture at the rated voltage and frequency as indicated on the specification table.

Utilizzare questo apparecchio a tensione e frequenza indicate nella tabella.

Die Leuchte darf nur mit der angegebenen Spannung und Frequenz betrieben werden.

Respecter les prescriptions de tension et de fréquence indiquées dans le tableau final.

Utilice esta lámpara a la tensión y frecuencia indicadas en las instrucciones.

4. This instruction sheet must be referred to any retained by the person responsible for the installation & servicing.

Queste istruzioni di montaggio devono essere conservate dal responsabile dell'installazione e manutenzione dell'apparecchio.

Bewahren Sie diese Gebrauchsanweisung für den verantwortlichen Benutzer /
Wartungstechniker auf.

Gardez cette instruction pour l'utilisateur /
technicien de maintenance.

Estas instrucciones debes ser conservadas por el responsable del mantenimiento de la instalación.

CAUTIONS

AVVERTENZE, WARNUNG PRECAUTIONS, PRECAUCIONES

1. Switch-off the power supply before any installation and maintenance operations.

Use only a two-pole switch

Staccare la linea elettrica prima dell'installazione e di ogni intervento di manutenzione.

Utilizzare un interruttore bipolare

Die Stromzufuhr muss vor der Installation /
Wartung ausgeschaltet werden.

Nur mit einem zweipoligen Stecker
zu verwenden

Couper la source d'alimentation avant toute
installation et opération d'entretien.

Seulement utiliser avec un
connecteur bipolaires

No efectuar la conexión de la
lámpara con la tensión general
activada.

Usar un interruptor bipolar

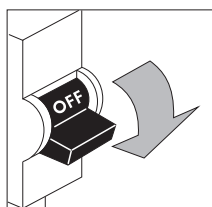

INSTALLATION

INSTALLAZIONE, MONTAGE INSTALLATION, INSTALACIÓN

1 **Conos**

G12 CDM-T M.H.	E27 PAR30 LED	E27 PAR30 (CDM-R) M.H.	GX8.5 CDM-R111 M.H.	G53 AR111/ G53 AR111 LED
6054 6055 6321 6322	6051	6050	6056	6052

Mini-Conos

GU5.3 MR16 / GU5.3 MR16 LED	GX10 MR16	G8.5 CDM-TC	E27 PAR20 LED	GU10/GZ10	E27 PAR20 (CDM-R)
6064	6061	6092 6100 6310 6311	6062	6063	6058

Micro-Conos

GU5.3 MR16 / GU5.3 MR16 LED	GU10/GZ10
6044	6045

2

Turn to "OFF" position when install or uninstall the fixture.

Quando installare o disinstallare il dispositivo, ruotare in posizione "OFF".

Installieren oder zu deinstallieren, wenn Sie das Gerät, auf "OFF"-Position drehen.

Lorsque installer ou désinstaller le luminaire, tourner à la position "OFF".

Al instalar o desinstalar el dispositivo, gire a la posición "OFF".

3

ART.

6050
6054
6055
6056
6321
6322
6323

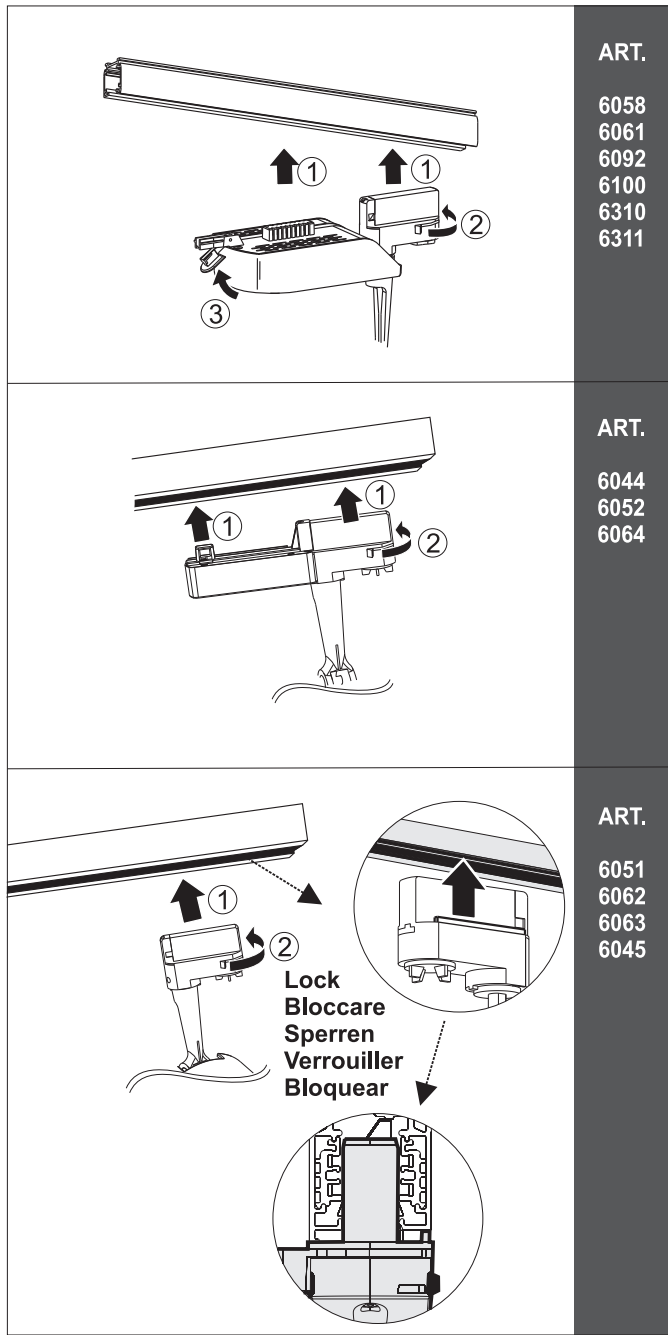

ART.

6058
6061
6092
6100
6310
6311

ART.

6044
6052
6064

ART.

6051
6062
6063
6045

ANGLE ADJUSTMENT

ORIENTAMENTO DEL VANO OTTICO
ORIENTERUNG DER OPTISCHEN
ORIENTATION DU GROUPE OPTIQUE
ORIENTABILIDAD DE LA OPTICA

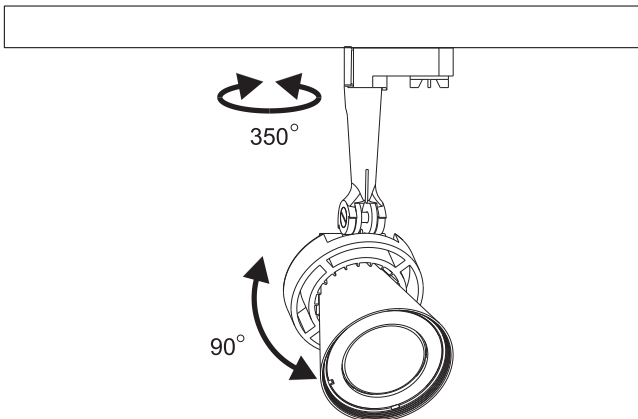

MEASUREMENT

DIMENSIONI, ABMESSUNGEN
DIMENSIONS, MEDIDAS

in mm

Conos

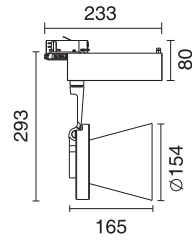

Art.
6050
6054
6055
6056
6321
6322
6323

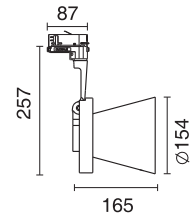

Art.
6051

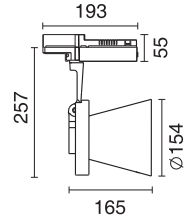

Art.
6052

Mini Conos

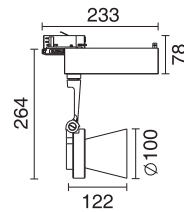

Art.
6058
6061
6092
6100
6310
6311

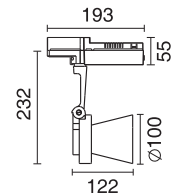

Art.
6064

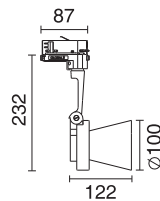

Art.
6062
6063

Micro Conos

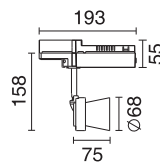

Art.
6044

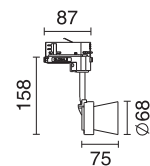

Art.
6045

SPECIFICATION

CARATTERISTICHE, BESCHREIBUNG CARACTERISTIQUES, ESPECIFICACIONES

Conos

Art.	Wattage(W)	Volt.(V) /f(Hz)	Lamp	Remarks	Class
6050	70	220-240 50/60	E27 PAR30 CDM-R M.H.	N.A.	
6051	12	220-240 50/60	E27 PAR30 LED	N.A.	
6052	75	220-240 50/60	G53 AR111	N.A.	
	15		G53 AR111 LED		
6054	70	220-240 50/60	G12 CDM-T M.H. (Spot light 10°)	N.A.	
6055	70	220-240 50/60	G12 CDM-T M.H. (Flood light 40°)	N.A.	
6056	70	220-240 50/60	GX8.5 CDM-R111 M.H.	N.A.	
6321	100	220-240 50/60	G12 CDM-T M.H. (Spot light 10°)	N.A.	
6322	100	220-240 50/60	G12 CDM-T M.H. (Flood light 40°)	N.A.	
6323	43/45	220-240 50/60	LED	N.A.	

IP20 IP40 CE

for G12

Mini Conos

Art.	Wattage(W)	Volt.(V) /f(Hz)	Lamp	Remarks	Class
6058	35	220-240 50/60	E27 PAR20 CDM-R M.H.	N.A.	
6061	35	220-240 50/60	GX10 MR16 M.H.	N.A.	
6062	7	220-240 50/60	E27 PAR20 LED	N.A.	
6063	50	220-240 50/60	GU10/GZ10 (Hal.)	N.A.	
	6		GU10/GZ10 LED		
6064	35	220-240 50/60	GU5.3 MR16	N.A.	
	Max. 15		GU5.3 MR16 LED		
6092	35	220-240 50/60	G8.5 CDM-TC M.H. (Spot light 10°)	N.A.	
6100	35	220-240 50/60	G8.5 CDM-TC M.H. (Flood light 40°)	N.A.	
6310	50	220-240 50/60	G8.5 CDM-TC M.H. (Spot light 10°)	N.A.	
6311	50	220-240 50/60	G8.5 CDM-TC M.H. (Flood light 40°)	N.A.	

IP20 IP40 CE

for G8.5

Micro-Conos

Art.	Wattage(W)	Volt.(V) /f(Hz)	Lamp	Remarks	Class
6044	35	220-240 50/60	GU5.3 MR16 Hal.	N.A.	
	Max. 15	220-240 50/60	GU5.3 MR16 LED		
6045	35	220-240 50/60	GU10/GZ10 Hal.	N.A.	
	6	220-240 50/60	GU10/GZ10 LED		

IP20 CE

Lamp not included.
Lampada non compresa.
Exklusive Leuchtmittel.
Sources lumineuses exclues.
Lâmpara no incluída.

formalighting

Forma Lighting (Italia) S.r.l.

Tel : (+39) 02 9354 0300

Fax : (+39) 02 9343 5117

Email : formaitalia@formalighting.it

Address : Via Europa, 35/A
20010 Pogliano Mil.se MI

Forma Lighting (HK) Ltd.

Tel : (+852) 2516 6500

Fax : (+852) 2516 6525

Email : forma@forma.com.hk

Address : Room 4, 5/F.,
Eastern Harbour Centre
28 Hoi Chak Street
Quarry Bay, Hong Kong.

